

Contact Dimensions:

521-P.C. Tail .025 Sq. (0.64 Sq.) - Tail LG. = .150 (3.81)
.125 (3.18) Contact Spacing x .250 (6.35) Row Spacing

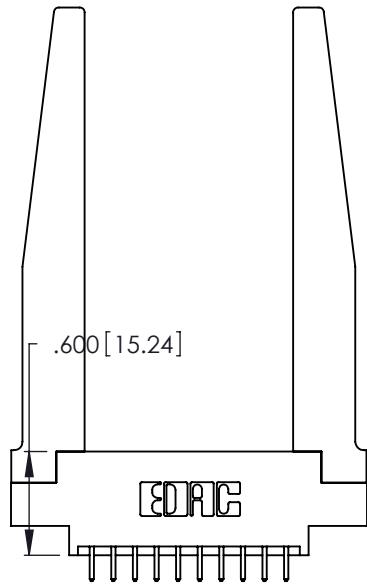
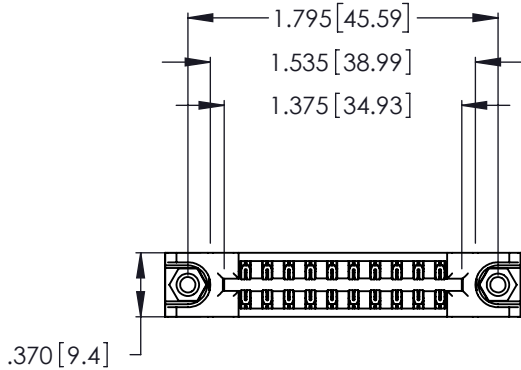

THIS IS A C.A.D. GENERATED DRAWING
 DO NOT MAKE MANUAL REVISIONS TO MASTER.

ISSUE NUMBER

ORIGINAL ①

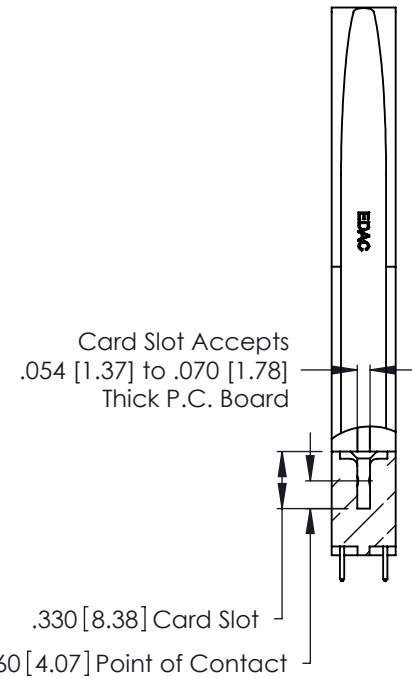

- INSULATOR MATERIAL: THERMOPLASTIC POLYESTER, UL 94V-0
- CONTACT MATERIAL; COPPER, NICKEL, TIN ALLOY CA-725
- CONTACT PLATING: GOLD ON THE MATING AREA, TIN-LEAD ON THE CONTACT TAILS, NICKEL UNDERPLATE

346/396 SERIES CARD EDGE CONNECTOR
PART NUMBER: 346-020-521-878



YOUR CONNECTION TO QUALITY & SERVICE

EDAC INC
 TORONTO, ONTARIO
 CANADA

THESE DRAWINGS AND SPECIFICATIONS
 ARE THE PROPERTY OF EDAC INC. AND
 SHALL NOT BE REPRODUCED, OR COPIED
 OR USED AS THE BASIS FOR THE
 MANUFACTURE OR SALE OF APPARATUS
 WITHOUT WRITTEN PERMISSION.

ACAD REFERENCE NO. 346-ENG-MASTER

DRAWN: J.LEE DATE: APR. 22/09

CHECKED: DATE:

SCALE: N.T.S SHEET 1 OF 2

DRAWING NUMBER 346-ENG-MASTER ISSUE 1

THIS IS A C.A.D. GENERATED DRAWING
DO NOT MAKE MANUAL REVISIONS TO MASTER.



ISSUE NUMBER	
ORIGINAL	①



Contact Code 555



Contact Code 556



Contact Code 558



Contact Code 559



Contact Code 560

- INSULATOR MATERIAL: THERMOPLASTIC POLYESTER, UL 94V-0
- CONTACT MATERIAL: COPPER, NICKEL, TIN ALLOY CA-725
- CONTACT PLATING: GOLD ON THE MATING AREA, TIN-LEAD ON THE CONTACT TAILS, NICKEL UNDERPLATE

346/396 SERIES CARD EDGE CONNECTOR CONTACT CODE 555,556,558,559,560 DIMENSIONS		ACAD REFERENCE NO.	346-ENG-MASTER
		DRAWN:	J.LEE
 EDAC INC TORONTO, ONTARIO CANADA YOUR CONNECTION TO QUALITY & SERVICE		CHECKED:	DATE:
		SCALE:	1:1
THESE DRAWINGS AND SPECIFICATIONS ARE THE PROPERTY OF EDAC INC. AND SHALL NOT BE REPRODUCED, OR COPIED OR USED AS THE BASIS FOR THE MANUFACTURE OR SALE OF APPARATUS WITHOUT WRITTEN PERMISSION.		DRAWING NUMBER	ISSUE
		346-ENG-MASTER	1