

# customer manual

ORIGINAL INSTRUCTIONS

**SAFETY PRECAUTIONS READ THIS FIRST!** ..... 2

**1. INTRODUCTION** ..... 3

    1.1. Declaration of Incorporation ..... 3

    1.2. Smart Applicator Machine Integration Kit ..... 3

    1.3. Smart Applicator Precision Controller Integration Kit ..... 4

    1.4. Smart Applicator Direct Integration Kit ..... 5

**2. RECEIVING INSPECTION AND INSTALLATION** ..... 5

    2.1. Receiving ..... 5

    2.2. Hardware Installation ..... 5

    2.3. Software Installation ..... 10

    2.4. Integration of Hardware and Software ..... 20

**3. SYSTEM III PRECISION CONTROLLER OPERATION** ..... 21

    3.1. Controller Screen, Navigation, and Operation ..... 22

    3.2. Feeder Calibration ..... 24

    3.3. I/O Interface Settings ..... 25

    3.4. Terminal Selection ..... 26

    3.5. Run Page Data ..... 28

    3.6. Applicator Page Data ..... 29

    3.7. Feeder Data ..... 31

    3.8. Precision Controller ..... 31

**4. SYSTEM III TERMINAL SERVO FEEDER OPERATION AND CALIBRATION** ..... 34

    4.1. Feeder Operation ..... 34

    4.2. Feeder Calibration ..... 35

**5. TERMINATION QUALITY** ..... 37

**6. MAINTENANCE** ..... 40

    6.1. Normal Preventive Maintenance and Lubrication ..... 40

    6.2. System III Feeder Maintenance ..... 40

    6.3. Clearing Jammed Terminal Strip ..... 41

    6.4. Precision Controller Maintenance ..... 41

**7. RESTRICTION ON HAZARDOUS SUBSTANCES (RoHS) INFORMATION** ..... 41

**8. REVISION SUMMARY** ..... 41

## SAFETY PRECAUTIONS — AVOID INJURY

Safeguards are designed into this application equipment to protect operators and maintenance personnel from most hazards during equipment operation. However, certain safety precautions must be taken by the operator and repair personnel to avoid personal injury, as well as damage to the equipment. For best results, application equipment must be operated in a dry, dust-free environment. Do not operate equipment in a gaseous or hazardous environment.

Carefully observe the following safety precautions before and during operation of the equipment:



*Always wear approved eye protection while operating equipment.*



*Always wear appropriate ear protection while using equipment.*



*Moving parts can crush and cut. Always keep guard(s) in place during normal operation.*



*Always insert power plug into a properly grounded receptacle to avoid electrical shock.*



*Always turn off the main power switch and disconnect the electrical cord from the power source when performing repair or maintenance on the equipment.*



*Never insert hands into installed equipment. Never wear loose clothing or jewelry that may catch in moving parts of the equipment.*



*Never alter, modify, or misuse the equipment.*

## TOOLING ASSISTANCE CENTER

**CALL TOLL FREE 1-800-722-1111 (CONTINENTAL UNITED STATES AND PUERTO RICO ONLY)**

The **Tooling Assistance Center** offers a means of providing technical assistance when required.

In addition, Field Service Specialists are available to provide assistance in the adjustment or repair of the application equipment when problems arise which your maintenance personnel are unable to correct.

### INFORMATION REQUIRED WHEN CONTACTING THE TOOLING ASSISTANCE CENTER

When calling the Tooling Assistance Center regarding service to equipment, it is suggested that a person familiar with the device be present with a copy of the manual (and drawings) to receive instructions. Many difficulties can be avoided in this manner.

When calling the Tooling Assistance Center, be ready with the following information:

1. Customer name
2. Customer address
3. Person to contact (name, title, telephone number, and extension)
4. Person calling
5. Equipment number (and serial number if applicable)
6. Product part number (and serial number if applicable)
7. Urgency of request
8. Nature of problem
9. Description of inoperative component(s)
10. Additional information/comments that may be helpful

**System III Precision Controller  
Installed on Komax Leadmaker  
with mci 722 Terminator**

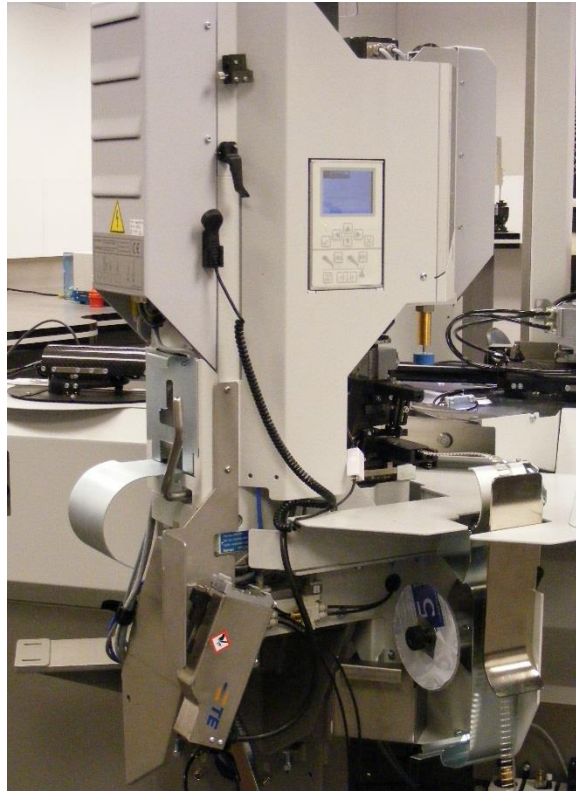

Figure 1

## 1. INTRODUCTION

This customer manual covers the system III smart applicator integration kits used with Komax leadmakers with mci 722 terminators only. See Figure 1.

When reading this manual, pay particular attention to DANGER, CAUTION, and NOTE statements.



**DANGER**

*Denotes an imminent hazard that may result in moderate or severe injury.*



**CAUTION**

*Denotes a condition that may result in product or equipment damage.*



**NOTE**

*Highlights special or important information.*

Reasons for re-issue of this customer manual are provided in Section 8, REVISION SUMMARY.



**NOTE**

*Dimensions in this customer manual are in metric units [with U.S. customary units in brackets]. Figures are not drawn to scale.*

### 1.1. Declaration of Incorporation

Check Declaration of Incorporation 2217124 prior to putting the machine into operation.

### 1.2. Smart Applicator Machine Integration Kit

The machine integration kit consists primarily of a connection box and software to integrate the host machine with precision controller integration kits and/or applicator direct integration kits.

Komax is a trademark.

### 1.3. Smart Applicator Precision Controller Integration Kit

The precision controller integration kit consists primarily of a precision controller, system III terminal servo feeder, and the hardware that attaches the controller and feeder to the appropriate Komax leadmaker.

The system III terminal servo feed assembly can be used in conjunction with system III applicators and Ocean applicators to provide the means for feeding terminals into the applicator for crimping. These applicators can then be used on select leadmakers.

**i** **NOTE**  
Optional feeder calibration block 1901063-1 is recommended.

The system III terminal servo feeder and system III precision controller are shown in Figure 2.

**System III Terminal Servo Feeder**

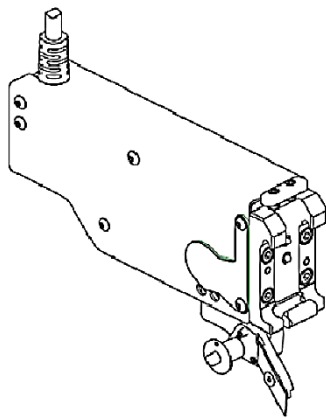

**System III Precision Controller**

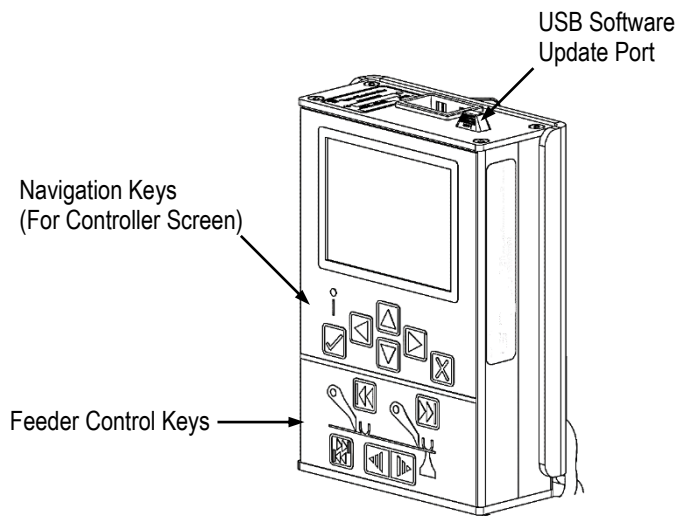

System III Terminal Servo Feeder Specifications	
Weight	1.66 kg [3.67 lb]
Length	206 mm [8.1 in.]
Depth	51 mm [2.0 in.]
Height	102 mm [4.0 in.]
Electrical	Supplied by the external power supply or leadmaker base machine
Temperature	4 to 40°C [40 to 104°F]
Relative Humidity	95% maximum non-condensing
Stroke	42 mm [1.66 in.] maximum
Speed	300 mm/sec max [11.8 in./sec max]
Adjustment Increment	0.020 mm [0.0008 in.]

Figure 2

## 1.4. Smart Applicator Direct Integration Kit

The direct integration kit consists of cabling, which connects the smart applicator to the Komax leadmaker. This kit is typically used when no servo feed applicators are used. This kit allows direct reading of data from mechanical-feed and/or pneumatic-feed applicators.

The system III precision controller (shown in Figure 2) is responsible for controlling the feeder assembly and displaying the applicator information through a series of controller navigation and feeder control keys. A description of the key operation is provided in Paragraph 3.1.

## 2. RECEIVING INSPECTION AND INSTALLATION

**i** **NOTE**  
*Refer to assembly drawing 2161650 or 2161655 located in the print pack. These drawings contain installation information, part numbers for components and assemblies, application information, and optional components that may be ordered separately as required. When received, the kit should be checked against the assembly drawing to verify that it is correct for the application, complete, and not damaged. Contact the Tooling Assistance Center at 1-800-722-1111 with any questions or to report any problems.*

### 2.1. Receiving

Each kit is thoroughly inspected during and after assembly. Prior to packaging and shipping, a final series of tests and inspections is made to ensure proper functioning of the kit. The following inspection should be performed as a safeguard against potential problems generated in transit:

1. In a well-lighted area, carefully uncrate the kit, and inspect each component as it is removed from the crate.
2. Thoroughly inspect each component for evidence of damage that may have occurred in transit. If any of the components are damaged, file a claim against the carrier and notify TE immediately.

Keep this manual and all drawings with the kit for the benefit of operation and maintenance personnel.

The controller and feeder should be inspected at regularly scheduled intervals, depending on care, degree of operator skill, and environmental conditions.

### 2.2. Hardware Installation

**i** **NOTE**  
*Hardware installation consists of installing the machine integration kit, precision controller integration kit(s), and/or direct integration kit(s).*

#### A. Installation of Machine Installation Kit

Refer to drawing 2651651 from the machine documentation package. This drawing contains hole cut-outs and installation instructions for the machine installation kit. This kit **must** be installed before the hardware and software can be integrated.

#### B. Installation of Machine Integration Kit with Precision Controller Integration Kit onto Komax Leadmaker

1. Remove the side covers (see Figure 3) from the existing terminating unit, and install modified side cover 2-509805-3. Refer to drawing 2161650. See Figure 4.

**i** **NOTE**  
*The side covers wrap around the terminator. Be careful **not** to damage the communication cable that is connected to the panel. This cable must be unplugged, then reconnected when installing the modified side cover.*

2. Install the adapter plate, feeder holder, cable cradle, and ball lock pins. Refer to Figure 4.
3. Install the system III precision controller onto the side of the terminator.
  - a. Route the power cable and the communication cable along the side of the terminator and through the height adjustment mechanism.
  - b. Route the cable along the back side of the terminator. See Figure 4 and Figure 5.

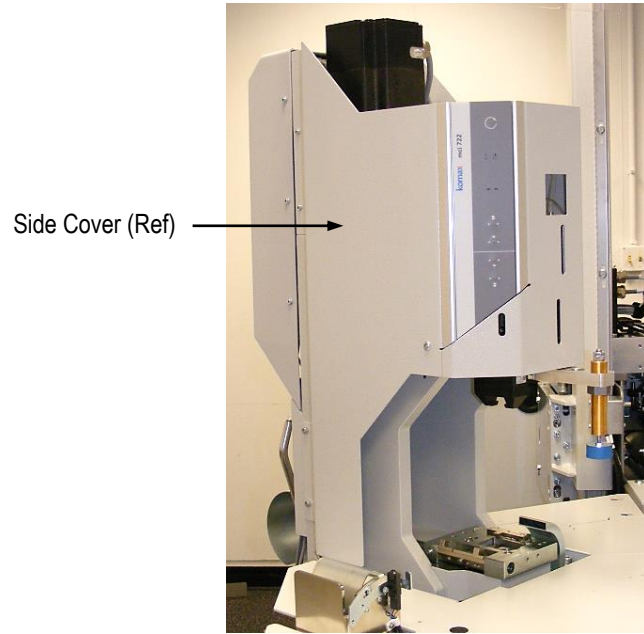

Figure 3

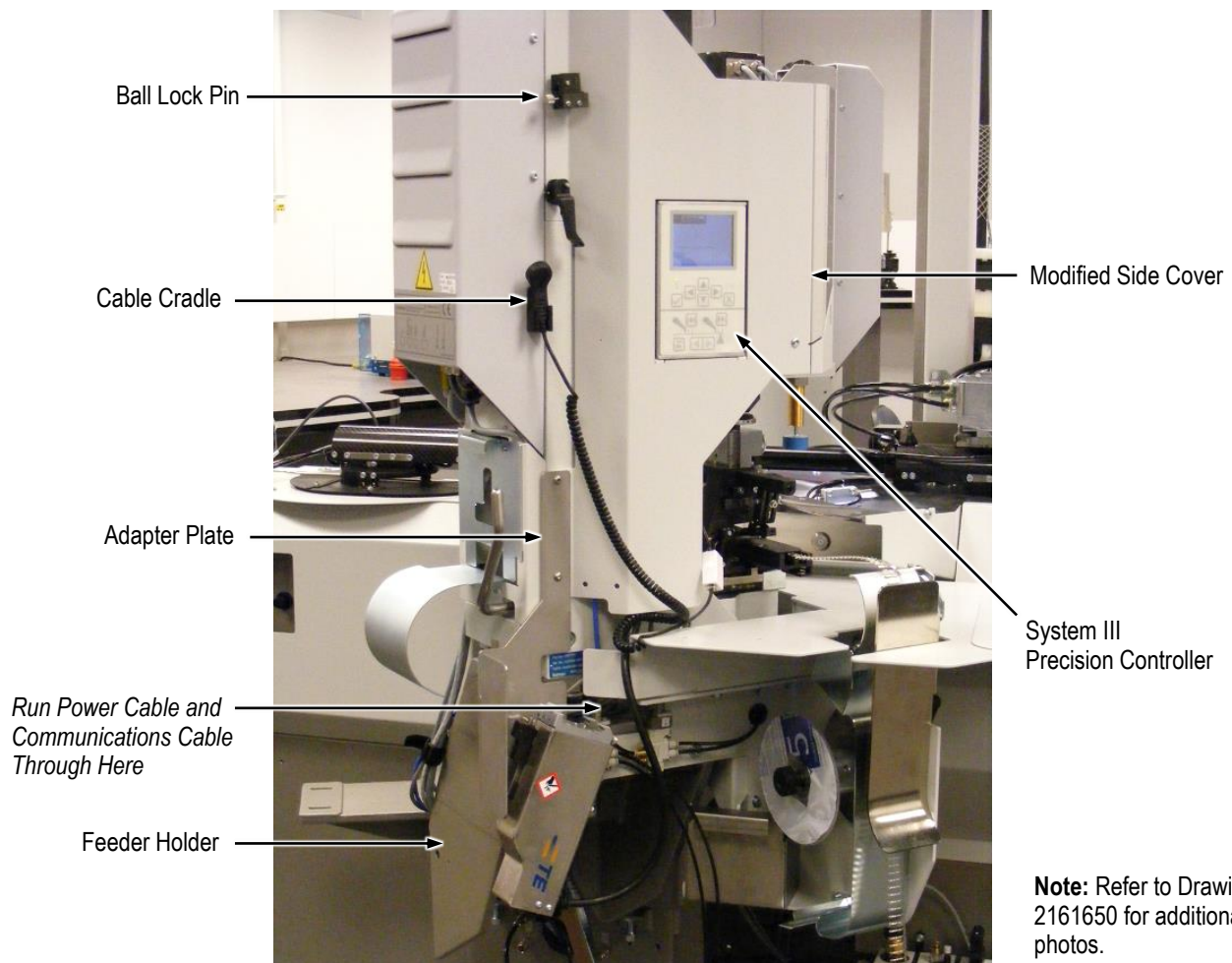

Figure 4

Power and Communication Cables Routed Along Back Side of Terminator



Cable Run Into Machine



Excess Cable in Wire Way

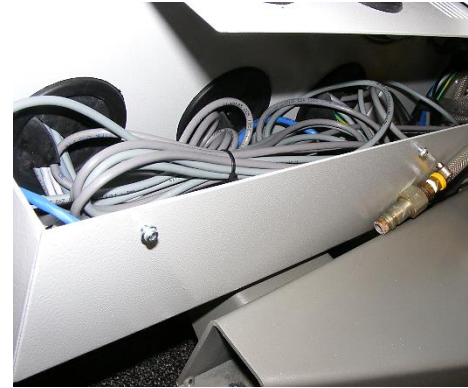

Access Cover Removed

Note: Cover Removed for Clarity

Figure 5

- c. Remove the access cover, and run the cable into the machine. See Figure 5. Run the power cable into the main electrical box. See Figure 6.



**NOTE**

Excess cable can be wire-tied and left in the wire way as shown in Figure 5.

- d. Connect the power cable to the power block and machine ground as shown in Figure 6. Refer to schematic 2161898 in documentation package 2161819.

The Ethernet communication cable is connected in the connection box as shown in Figure 7.

Power Block Located on Right Side of Main Electrical Box

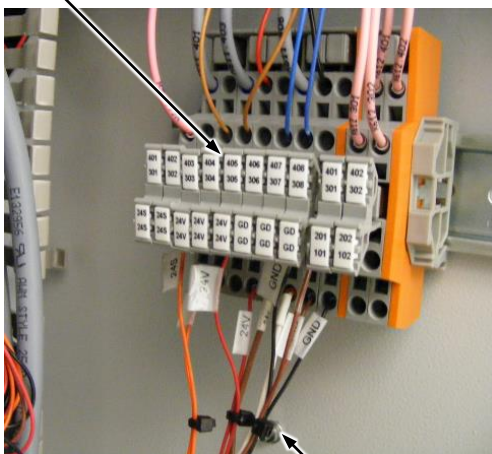

Power Cable

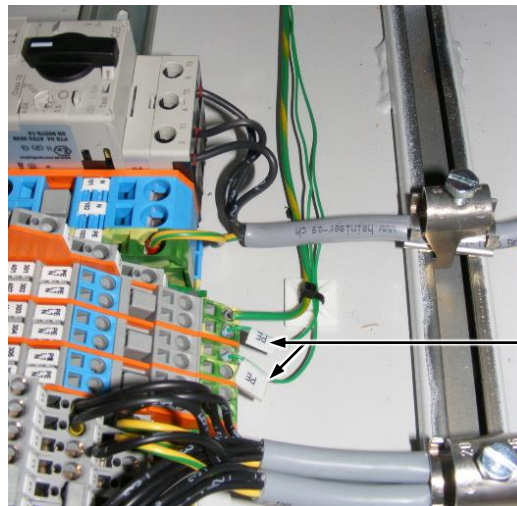

Ground Connections on Bottom of Electrical Cabinet

Figure 6

Computer Communications Cable  
Connected to USB Port  
on Main Computer

Ethernet Communications Cable

2 Kits Shown Installed

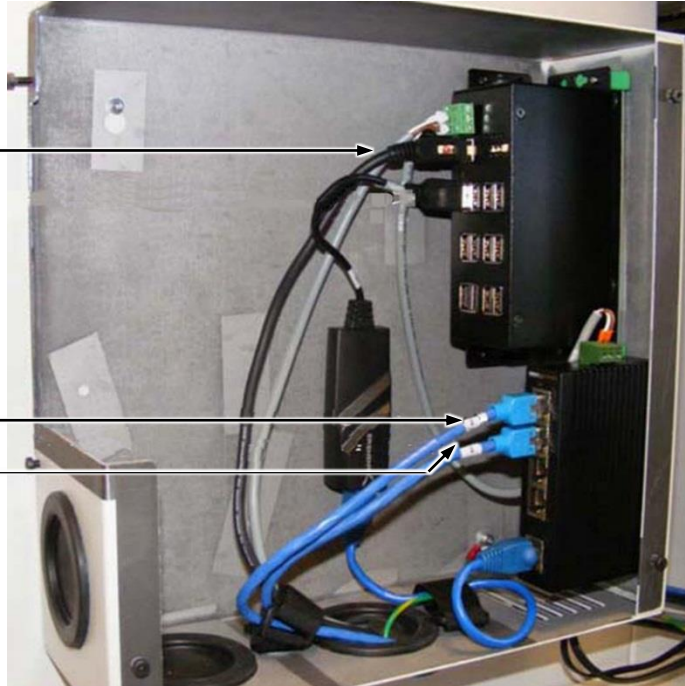
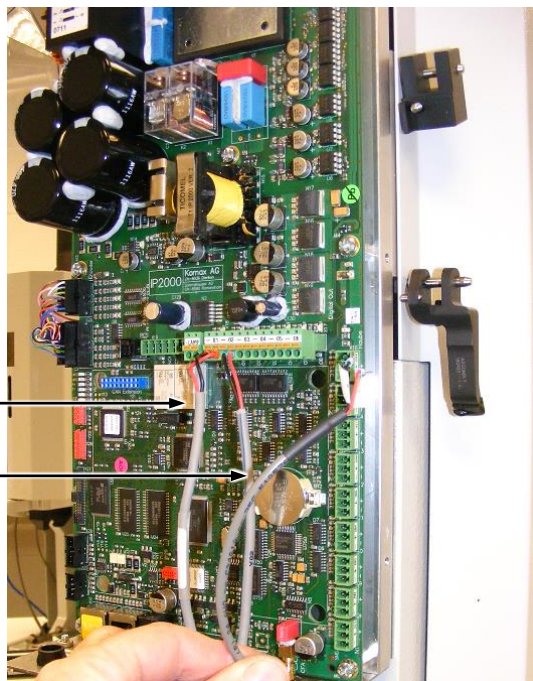

Figure 7

4. Route the trigger cable into the back of the terminator, and connect the trigger cable to the air feed cable. See Figure 8.
5. Remove the air feed cable from the back of the terminator. See Figure 8.
6. Cut and splice *both* air feed cable and the trigger cable as shown in Figure 8. Connect both cables to the connector block on the terminator. **Make sure to maintain polarity.**

Air Feed Cable

Trigger Cable



Air Feed Cable  
and Trigger Cable  
Spliced Together

Splices

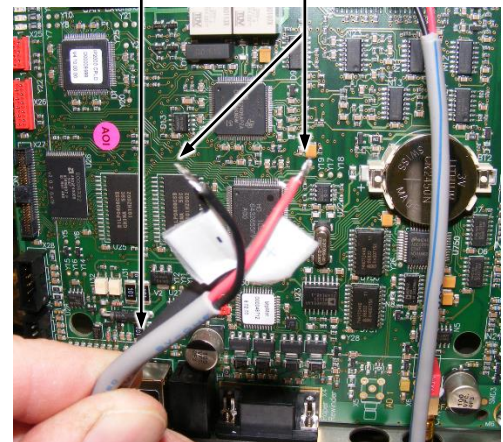

Figure 8



See schematic 2161898 for connection. Ensure that the black wire (-) goes to the (-) and the red wire (+) goes to the (01). Refer to Figure 9.

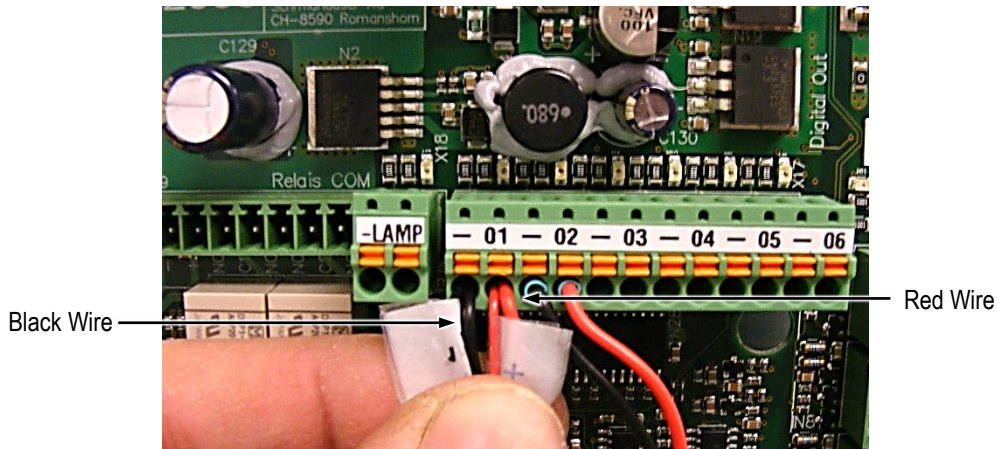

Figure 9

### C. Installation of Direct Integration Kit

1. Install the cable cradle. Refer to drawing 2161655. See Figure 10.

**i** **NOTE**  
Make sure to use the existing hardware.

2. Install the phone cable through the machine and into the connection box. See Figure 10. Remove the machine access panel to aid in fishing cables through the machine.



Figure 10

3. Connect the phone cable to the adapter, and then to the USB hub. See Figure 11.
4. Connect the cable probe to the phone cable using the inline coupler. See Figure 11.

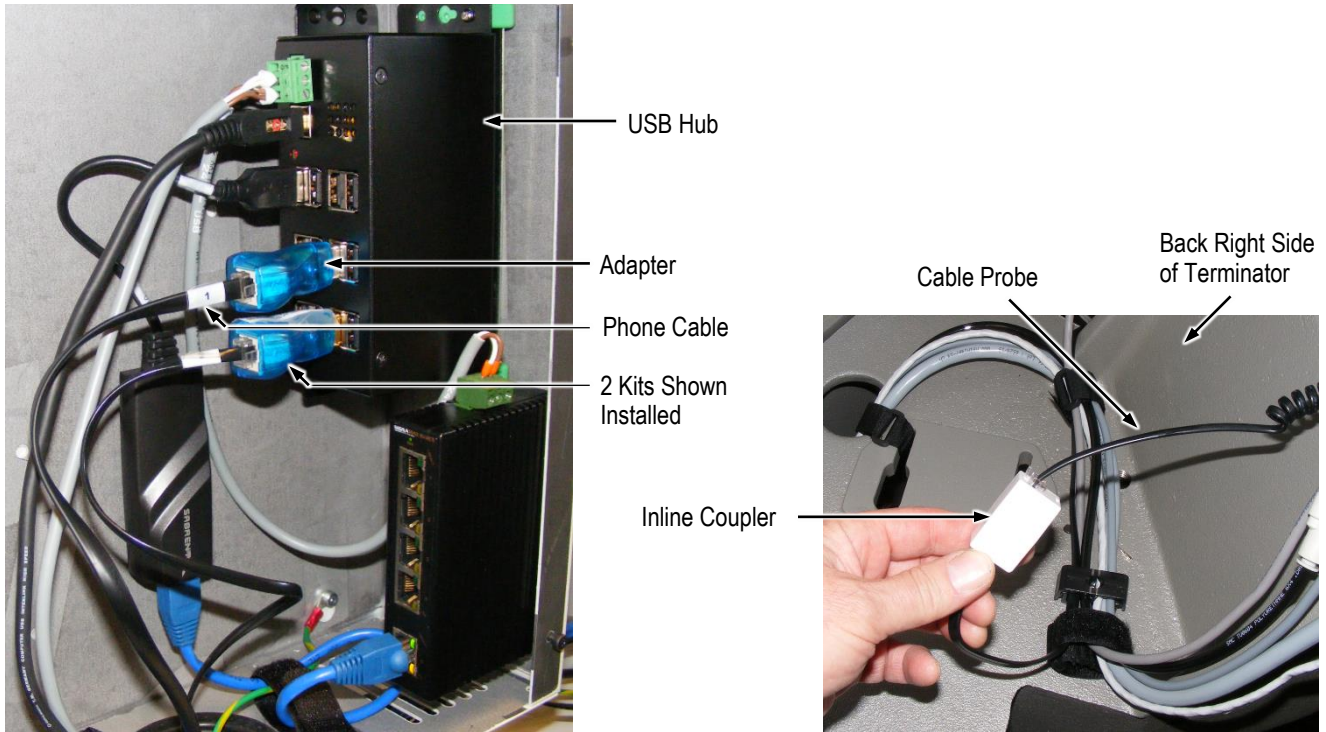

Figure 11

### 2.3. Software Installation

1. Verify that the TopWin software version on the machine is:
  - 12.4 or newer for Komax leadmaker A355, A355S, A356
  - 13.2 or newer for Komax leadmaker G263
  - 13.3 or newer for Komax leadmaker A488S
  - 14.1 or newer for Komax leadmaker A477, A488
  - 14.2 or newer for Komax leadmaker Z633

2. Install the TE server application on the machine by copying the file "ApplicatorDataSetup\_Version\_5.0.6.exe" (or newer) to the machine.

When this file is executed, it will install the TE server application and necessary utilities.

During the installation:

- the installer *must* accept the software license agreement,
- the software license agreement *must* be accepted by the operator,
- and the installer must have administrator's rights to install the programs.

During installation, the following will happen:

- a. ErrorLogService will install,
- b. DNSDiscoverService will install,
- c. TE Interfacell dll will install,
- d. Postgres database will install and build the database,
- e. Shortcuts will be created in the START menu in "Start->All Programs->ApplicatorData", and
- f. A program will enable all the ports necessary in the firewall to allow the TEServerApp and utilities to operate properly.

TopWin is a trademark.

## A. Set Up Ethernet Port for System

1. Verify that the software version is correct according to step 1 of Paragraph 2.3.
2. Configure the host machine IP address to 169.254.1.100.

For Windows XP operating system software:

- a. Install the USB to the Ethernet converter included with smart applicator machine integration kit 2161651-1. After the software installs the drivers, proceed with the next step.
- b. Click the Start button and then "Control Panel".
- c. In the new window, click "Network Connections".
- d. Locate and double click the "Local Area Connection X" (that corresponds to the USB) to the Ethernet connection. The device will be "ASIX AX88178 USB2.0 to Gigabit Ethernet Adapter".
- e. Click "Properties".
- f. In the center of the dialog, locate and double click "Internet Protocol" to open the Properties dialog.
- g. In the center of the new dialog, click "Use the following IP address:"
- h. Add the "IP address" and "Subnet mask" as shown in Figure 12.
- i. When complete, click "OK" and then close all the dialog windows.

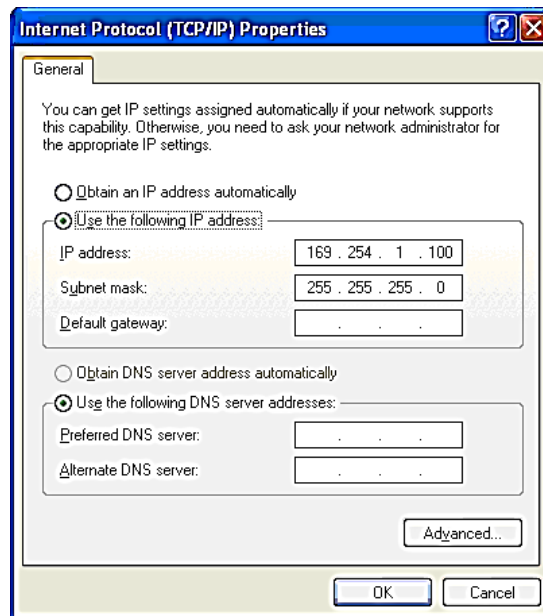

Figure 12

For Windows 7 operating system software:

- a. Install the USB to the Ethernet converter included with smart applicator machine integration kit 2161651-1. After the software installs the drivers, proceed with the next step.
- b. Click the Start button and then "Control Panel". Add the TopWin software license to the machine. Obtain the Komax leadmaker license certificate, and add the license key to the TopWin software on the Option Editor screen.
- c. In the new window, click "Network and Sharing Center".
- d. On the left side of the window, click "Change adapter settings".
- e. Locate and double click the "Local Area Connection X" (that corresponds to the USB) to the Ethernet connection. The device will be "ASIX AX88178 USB2.0 to Gigabit Ethernet Adapter".
- f. Click "Properties".

Windows XP is either a registered trademark or trademark of Microsoft Corporation in the United States and/or other countries.

- g. In the center of the dialog, locate and double click "Internet Protocol Version 4(TCP/IPv4)" to open the Properties dialog.
  - h. In the center of the new dialog, click "Use the following IP address".
  - i. Add the "IP address" and "Subnet mask" as shown in Figure 12.
3. Add the TopWin software license to the machine. Obtain the Komax leadmaker license certificate, and add the license key to the TopWin software on the Option Editor screen.
- a. Click "License on the right-hand side". See Figure 13.
  - b. Click "Add", and enter the license key. See Figure 13.

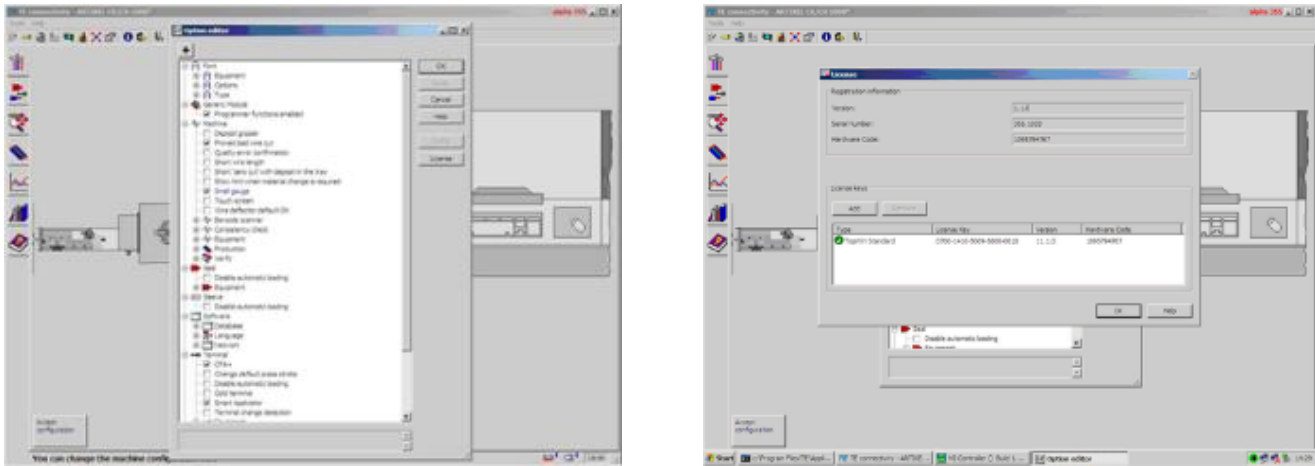

Figure 13

4. Configure the settings for the station to enable the smart applicator functions.

- i** **NOTE**  
When configuring a station to have an applicator direct connection, make sure to select the appropriate USB device ID using the Config button.
- i** **NOTE**  
If using the precision controller, make sure to enable the Air Feed option in the terminator configuration.

**B. Configuration of Smart Applicator Option on Machine**

1. Enter the Change Configuration screen. Refer to Figure 14.



Figure 14

- Under “Tools”, click “Option Editor” (it may take time for the “Option Editor” to appear). See Figure 15.

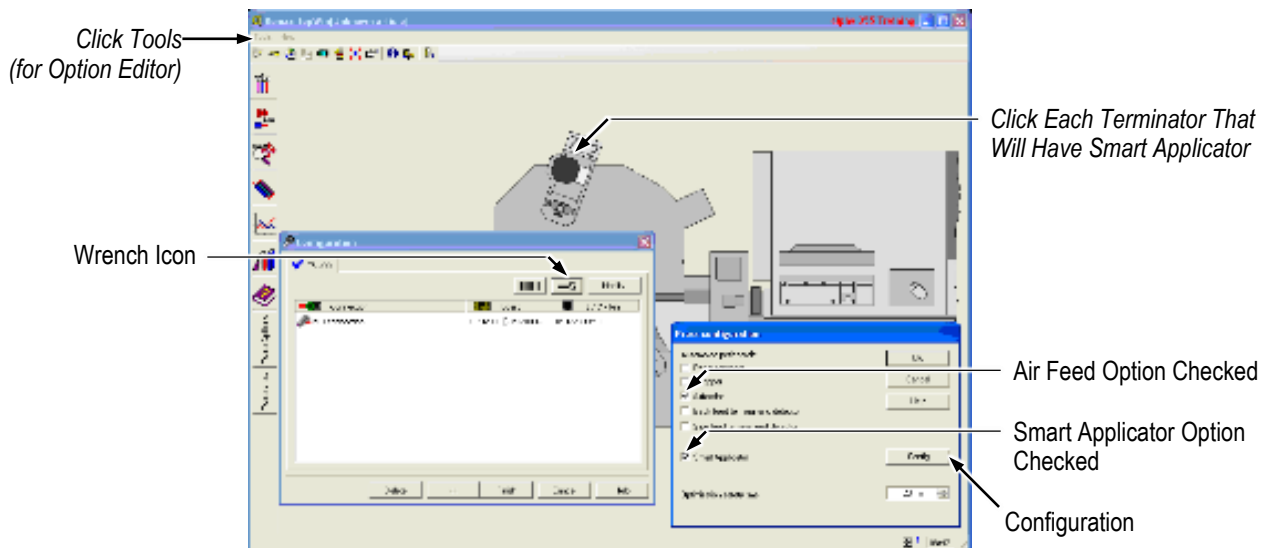

Figure 15

- Enable “Smart Applicator” under “Terminal” (this will enable the feature on the machine).



**NOTE**

The license number is required.

- Click each terminator that will have a smart applicator to display the Terminator Configuration screen. See Figure 15.
- Click the Wrench icon to configure the terminator.
- Enable the Smart Applicator option and Air Feed option.
- If the station is using an applicator direct connection, click the Config button to select the USB device ID. This device ID is printed on a label on the USB to one-wire converter in the connection box.  
If there is no USB device ID when the Config button is pressed, then it may be necessary to insert the USB to one-wire converter first. This may require the software driver to be installed according to step 1 of Paragraph 2.4, Integration of Hardware and Software.
- Click OK to save the settings.
- Repeat steps 4, 5, 6, and 7 for each terminator that will have a smart applicator connection.
- Accept the configuration.
- For an applicator direct connection, select the device ID from the list. See Figure 16. The USB to one-wire adapter must be plugged in and the device drivers installed **before** the list will show the adapters.

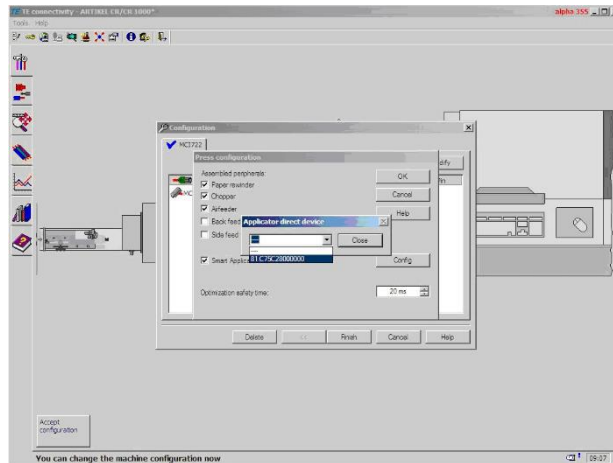

Figure 16

12. At this point, the machine will have the smart applicator features installed.

To use the data contained in the smart applicator, it is necessary to configure the terminals to be run in production properly.

In addition to the terminal name, or mapped terminal, the crimp height and cross section can be verified as well. This option is enabled by clicking the Config button at the right of the Option editor. Refer to Figure 17.

**TopWin Software Option Editor**

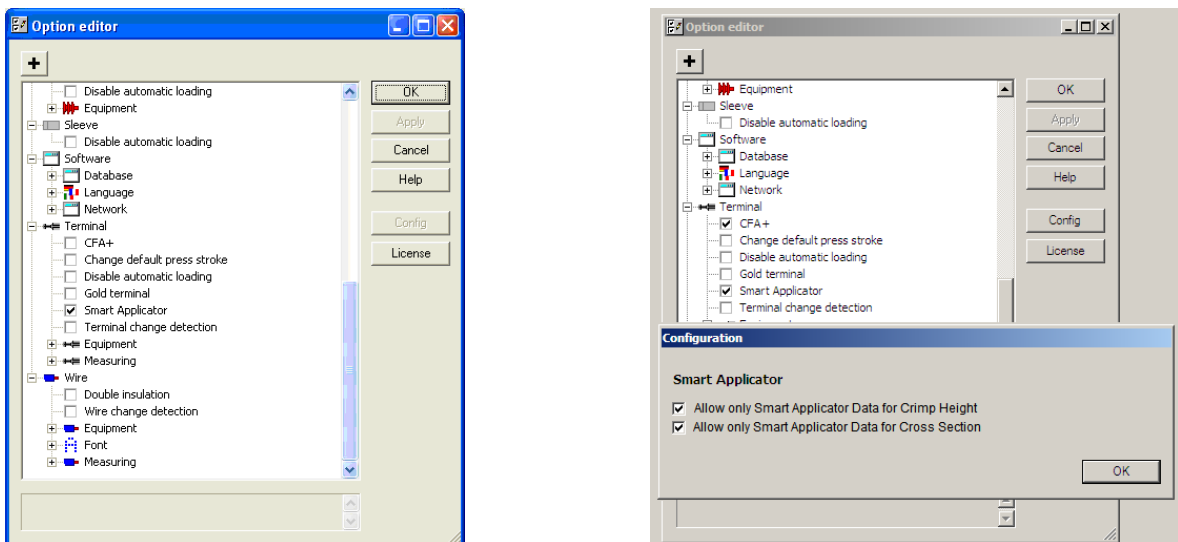

Figure 17

These settings affect the operation of all stations. If the smart applicator is checked, the machine will always check for the applicator, crimp height, and cross section for the installed smart applicator on the terminator, and display a warning.

When the smart applicator setting is turned on, the machine will always check for a smart applicator during the verification process prior to entering production. During the verification process, the data programmed in the machine is compared to the data in the applicator to verify a match.

If "Allow only Smart Applicator data for Crimp Height" is checked or "Allow only Smart Applicator data for Cross Section" is checked, the machine will not complete the verification process and will not enter production if there is no smart applicator connected.

If both boxes are not checked, the machine will complete the verification process and enter production when there is no smart applicator connected, but an error/warning will be displayed (click the OK button to continue).

For possible error messages and solutions, refer to Figure 18.

SMART APPLICATOR ERROR MESSAGE	DESCRIPTION	POSSIBLE SOLUTION
"Crimp Height Not Supported"	Crimp height specified for the wire in the terminal editor does not match the smart applicator data.	<ol style="list-style-type: none"> <li>1. Verify the crimp height in the terminal editor is matched in the smart applicator data.</li> <li>2. Turn off "Allow only Smart Applicator data for Crimp Height" in the Options editor to allow production with a non-standard crimp height.</li> </ol>
"Cross Section Not Supported"	The wire cross section specified for the wire in the terminal editor does not match the smart applicator data.	<ol style="list-style-type: none"> <li>1. Verify the wire cross in the terminal editor is matched in the smart applicator data.</li> <li>2. Turn off "Allow only Smart Applicator data for Cross Section" in the Options editor to allow production with a non-standard cross section.</li> </ol>
"No Applicator Connected"	No applicator was detected on the station or terminator.	<ol style="list-style-type: none"> <li>1. Plug in the applicator.</li> <li>2. Turn off "Allow only Smart Applicator data for Cross Section" and "Allow only Smart Applicator data for Crimp Height" in the Options editor to allow production without a smart applicator attached.</li> <li>3. Check that the smart applicator setting for the terminator is configured correctly for the precision controller connection or an applicator direct connection.</li> </ol>
"Register Failed"	The precision controller and the machine failed to initialize the communication.	<ol style="list-style-type: none"> <li>1. Check that the air feed signal from the terminator to the precision controller is connected properly.</li> <li>2. Check that the precision controller is configured properly in the options editor of the TopWin software.</li> <li>3. Check that the IP address on the precision controller is configured properly.</li> </ol>
"Load Data"	Data is transferred from the smart applicator to TopWin software.	<ol style="list-style-type: none"> <li>1. This is normally shown, momentarily.</li> <li>2. If the transfer fails, another error will appear.</li> </ol>
"Applicator Maintenance is Needed (SN:691905)"	One of the tool counters in the smart applicator has exceeded its targets.	Go to the Smart Applicator Maintenance screen, and reset the tool count.

Figure 18

It is important for the operation of the smart applicator features that the Compulsory Verifying option be turned on (Option editor > Machine > Verify > Activate).

When the Compulsory Verifying option is not turned on, the Verify Crimp Height icon at the bottom of the screen will appear with an exclamation point. See Figure 19. In this mode, the TopWin software will allow the operation of the smart applicator without fully verifying the crimp height.

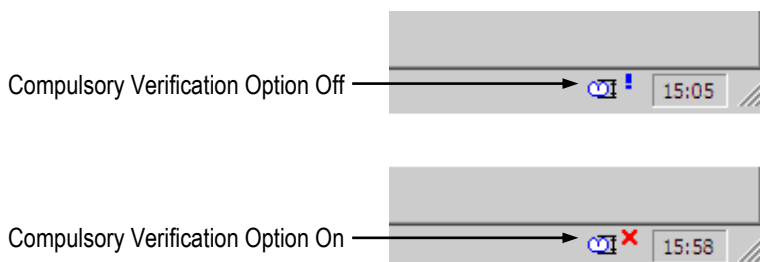

Figure 19

13. There are several ways to configure a terminal for production using the data in the smart applicator.
  - Create/copy a terminal with a name that is in the applicator.
  - Create/copy a terminal with a user given name, and map this terminal to a terminal in the applicator.
14. It is important to configure the terminal with the correct crimp height and cross section.
  - a. After the terminal is selected and mapped to a terminal in the applicator, the cross section and crimp height can be added in the Terminal Quality tab for crimp height by clicking the Add button. If the terminal in the title is in the applicator connected to the station, the correct cross section and crimp height values will be added automatically.
  - b. Continue to press the Add button until all of the cross section and crimp heights are added.



**NOTE**

If the terminal name and crimp height are not set up in the terminal before the Verify and Learn button is pressed, a screen will appear to allow the operator to map the terminal to a terminal in the applicator or to select the proper crimp height from the data in the smart applicator. See Figure 20.

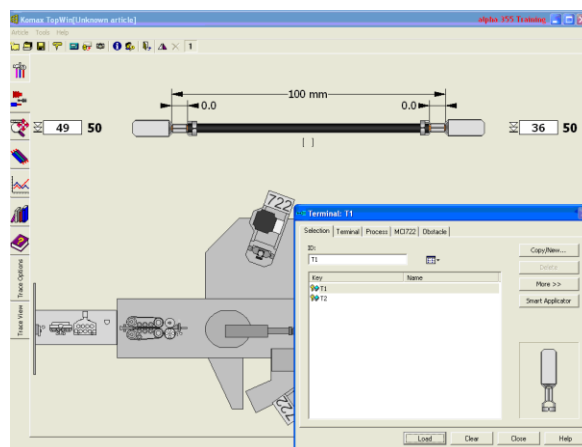

Figure 20

**C. Enabling the Smart Applicator Features in TopWin Software**

1. Install the precision controller.

The precision controller is actuated by use of the air feed signal from the machine. In the mci 722, the air feed signal comes from the terminating unit. It is necessary that the Air Feed option in enabled in the terminator configuration as well as enabled for each terminal. Make sure to turn on the Air Feeder option in the terminator configuration and in each terminal. See Figure 21.

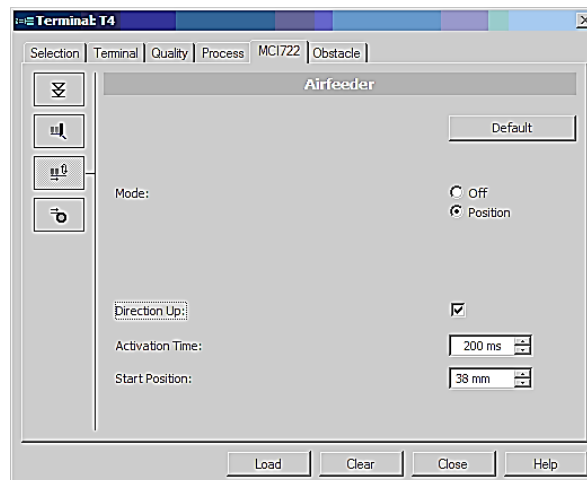

Figure 21



**i** **NOTE**  
For detailed instructions, refer to Paragraph 2.3, Software Installation.

2. Configure the IP address on the precision controller.

Each precision controller will connect to the machine (TEServerApp application) with a specific and unique IP address. If there are more than one precision controller in the system, it will be necessary to configure the IP address of each unit. Additionally, a new precision controller will not be configured properly to function on a Komax leadmaker. Configure the IP address of each precision controller as follows:

- a. Power up the precision controller.
- b. Click the right arrow until the Precision Controller icon is highlighted.
- c. Click the arrow to enter the “IO Interface Page”. See Figure 22.
- d. Click the right arrow to the “Settings Page”. See Figure 22.

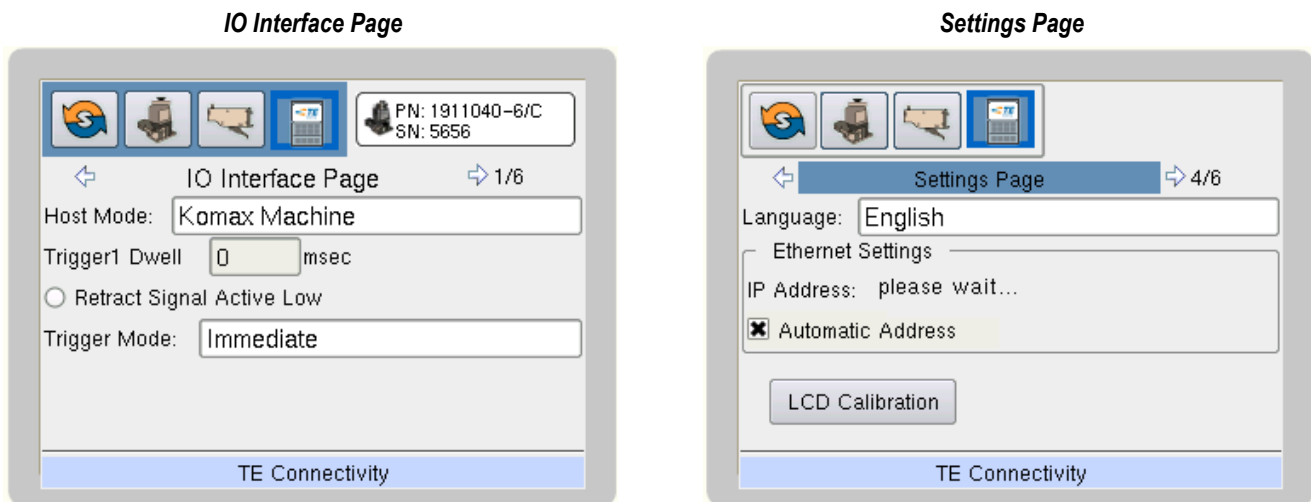

Figure 22

If the “Ethernet settings” has an IP address, the Ethernet connection is turned on as shown in Figure 23. If there is only one precision controller, the configuration is complete.

If the “Ethernet Settings” indicates “please wait ...”, the precision controller is looking for an automatic setting of the Ethernet address and must be changed. See Figure 23.

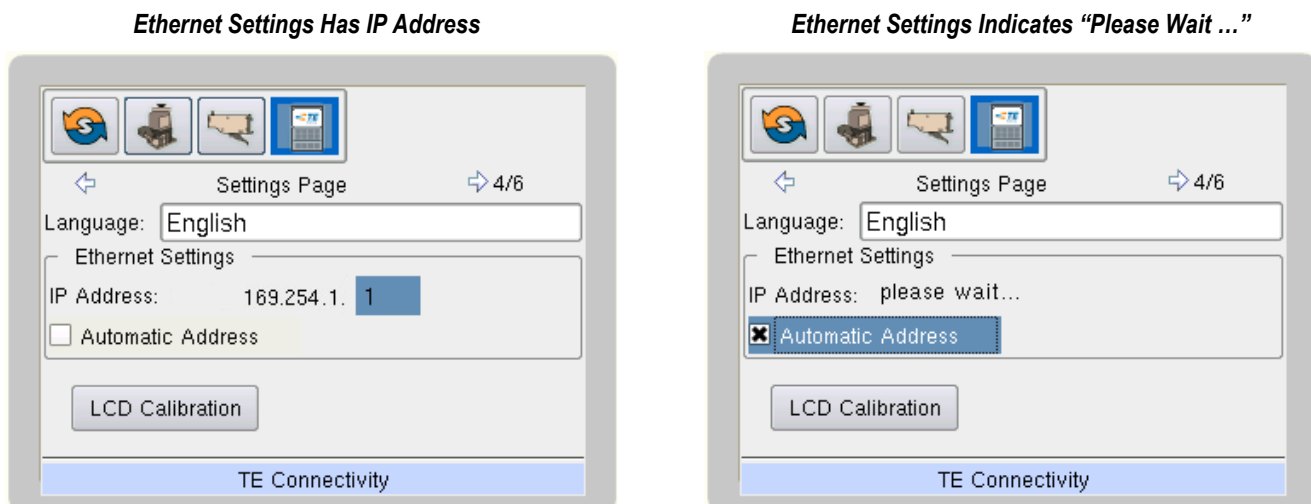

Figure 23

- e. When the precision controller is connected to a Komax leadmaker, the IP address will need to be set. Click down until “Automatic Address” is highlighted as shown in Figure 22. Then click the Check button. This will uncheck the box with the X. The screen will change to show an IP address of 169.254.1.1 as shown in Figure 22. This may take some time.



**NOTE**

*If there is more than one precision controller in the system, each unit must have a unique IP address. It is recommended that that station 1 have an IP address of 169.254.1.1 and station 2 have an IP address of 169.254.1.2.*

To change the IP address, click the Up button until the last digit of the IP address is highlighted. Click the Check button to enable the setting of the last digit of the IP address. See Figure 24.

Use the up/down arrows to set the last digit to the desired number. Refer to Figure 24. Then click the Check button again to accept the new IP address.

The IP address can be set from 1 to 9.



**NOTE**

*It is important to power off the machine after the IP address on the precision controller is changed. This will allow the software to obtain the correct IP address when the machine is powered up.*

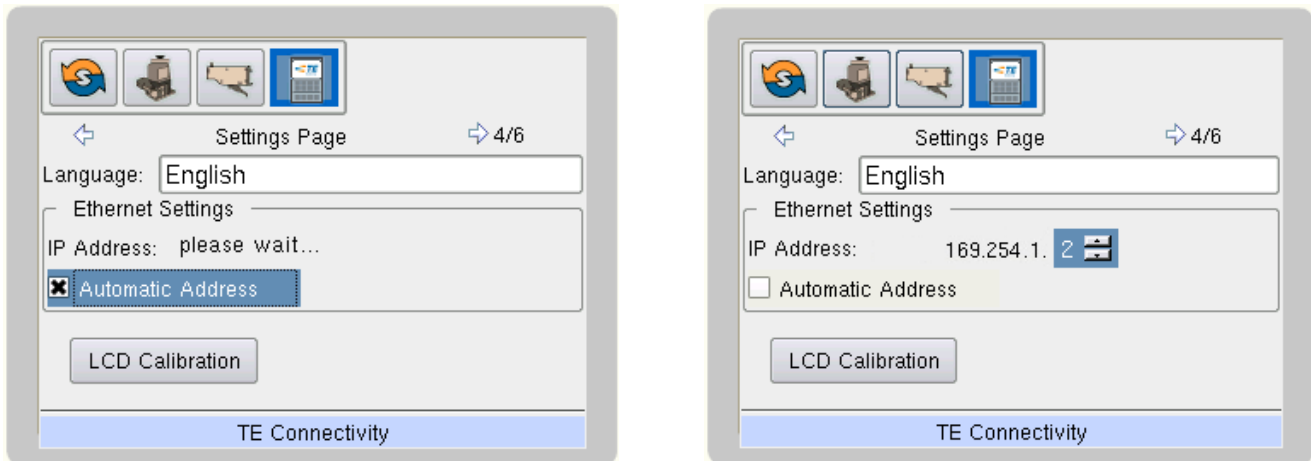

Figure 24

**D. Viewing the Smart Applicator Data**

1. To view the smart applicator data, select the terminator in the TopWin software Setup screen. See Figure 25.

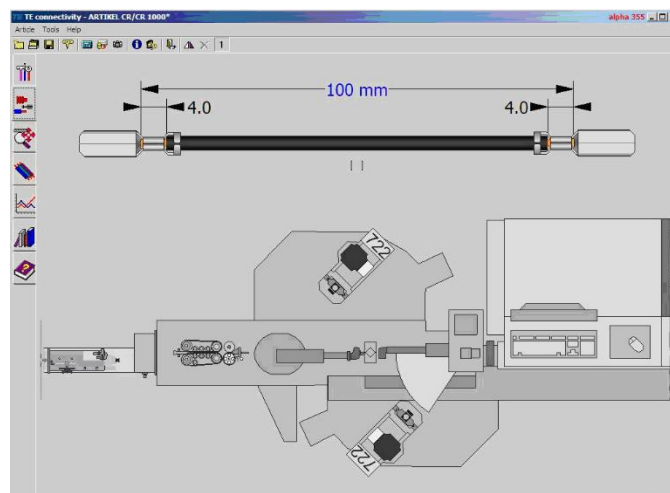

Figure 25

- In the Terminal Editor screen, there is a list of terminals programmed in the TopWin software. To see the list, click “Smart Applicator”. See Figure 26.
- The pop-up screen shows the list of terminals and mapped terminals that are in the smart applicator. The smart applicator system will run **only** with the terminals listed here. To map a terminal, select it on the TopWin software list, then enter the Smart Applicator screen, select a terminal, and click “Map”. See Figure 26.

**Terminal Editor Screen**

**Smart Applicator Screen**

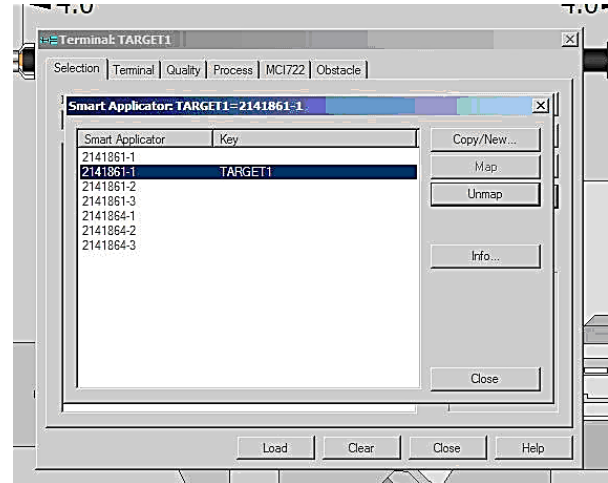
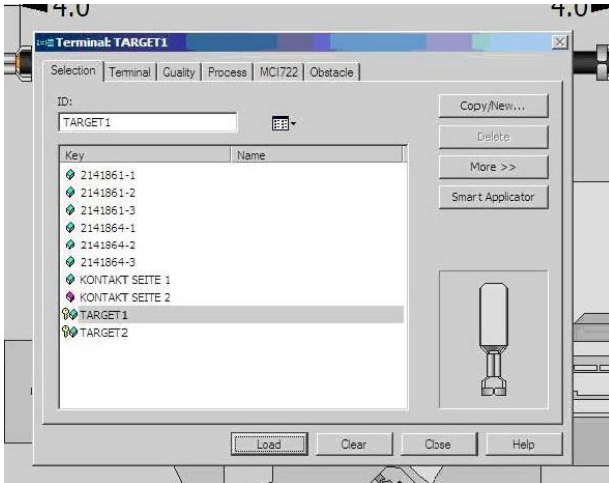

Figure 26

- To view all the data in the smart applicator, click the Info button. Refer to Figure 27. This screen shows all the data from the smart applicator.
- To set the terminator counters, click “Maintenance”. When a smart applicator is attached to the terminator, it is possible to go to the applicator Maintenance screen. The smart applicator has 10 tool counters. Each counter has a description, target, counts to target, and the date the count was reset. These counters work off the smart applicator cycle count. See Figure 27.

**All Data in Smart Applicator**

**Applicator Maintenance Screen**

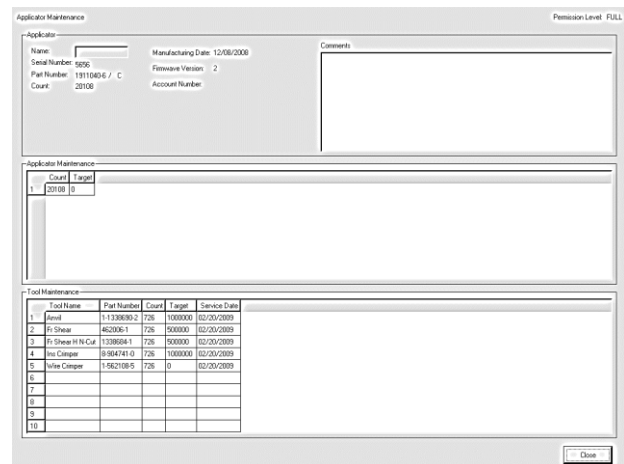
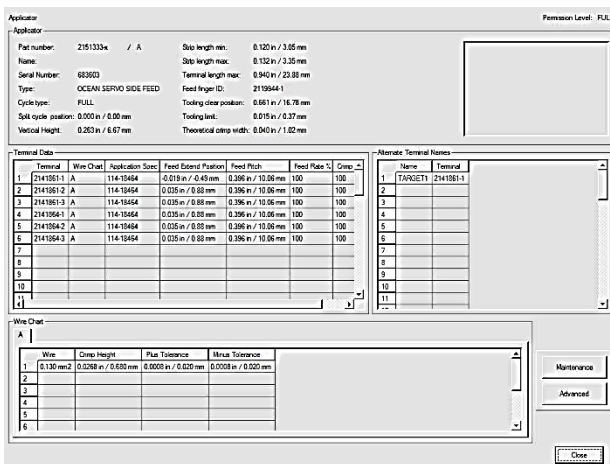

Figure 27

6. To change the values of a counter, click the tool listed in the Maintenance screen.
  - When the target count is set to a value, the counter is active. If the target is set to “0,” then the counter is not active.
  - When a target count is exceeded, a message will be displayed on the machine until the count is reset.

On the Tool Maintenance Data screen, the target count can be set and the count for the tool can be reset. The service date will be updated, as well as the current date when the count was reset. Press the Apply button to save the changes. See Figure 28.

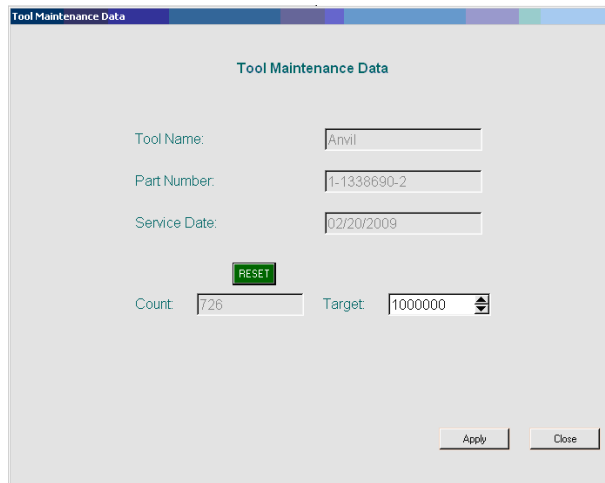

Figure 28

## 2.4. Integration of Hardware and Software

1. When the software is installed on Windows XP, the “USB Host for One-Wire Network for using WinUSB” files are copied to the hard drive. When the USB to one-wire adapter is plugged into the USB port of the computer, the software driver will need to be installed. To install the driver, follow the “USB One-Wire Converter Software Driver Installation on Windows XP”.
2. When Windows XP detects the “Dallas USB Device”, the “New Hardware” wizard should open. See Figure 29. Select “No, not at this time”. Then, click “Next”.
3. Select “Install the software automatically”. Then, click “Next”. See Figure 29.

**“No, Not at This Time” Selected**



**“Install the Software Automatically” Selected**



Figure 29

- The New Hardware wizard will search and install the driver. See Figure 30. Then click “Finish”. See Figure 30.

**New Hardware Wizard Searching**



**Click “Finish”**

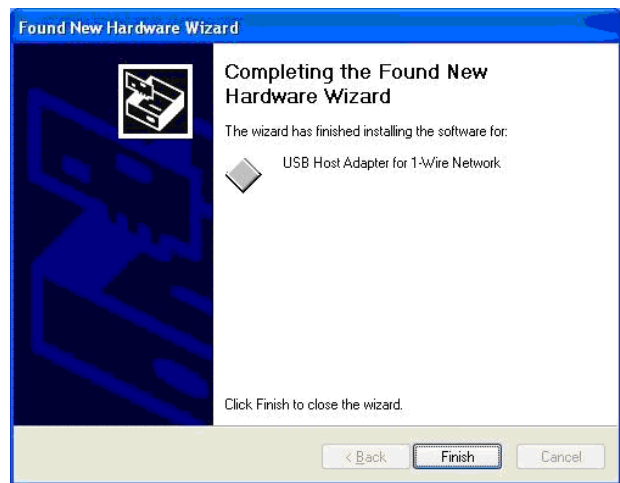

Figure 30

At this point, the “USB Host for One-Wire Network” is installed.

### 3. SYSTEM III PRECISION CONTROLLER OPERATION

The controller can be described as three functional sections. See Figure 31.

- the top of the controller contains the controller screen,
- below the screen are the controller screen navigation keys, and
- below the controller screen navigation keys are the feeder control or operation keys.

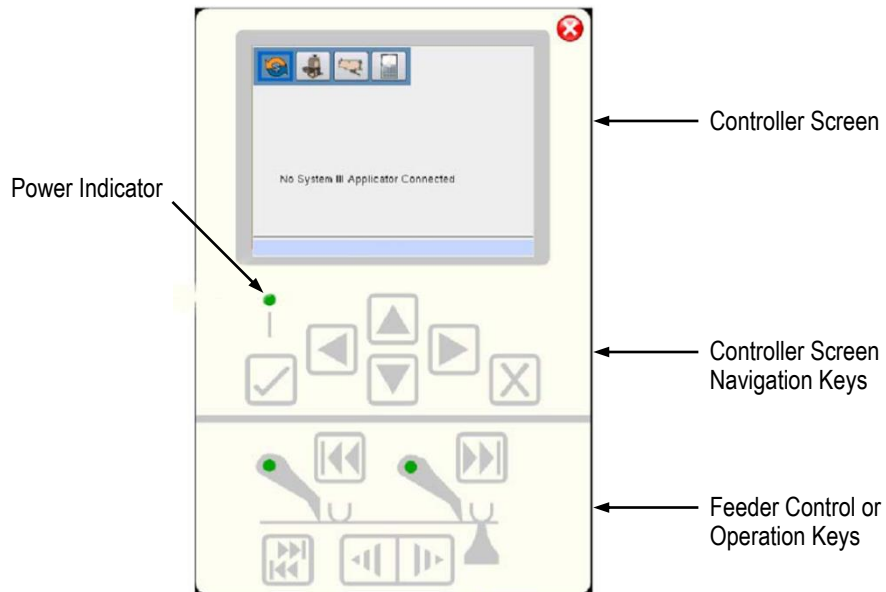

Figure 31

### 3.1. Controller Screen, Navigation, and Operation

#### A. Controller Screen

Each screen contains four icons across the top of the screen in a main menu bar, which include a Run icon, Applicator icon, Feeder icon, and Controller icon. See Figure 32.

**i NOTE** If an applicator is connected, an Applicator Connected indicator will be visible in the upper right corner of the screen.

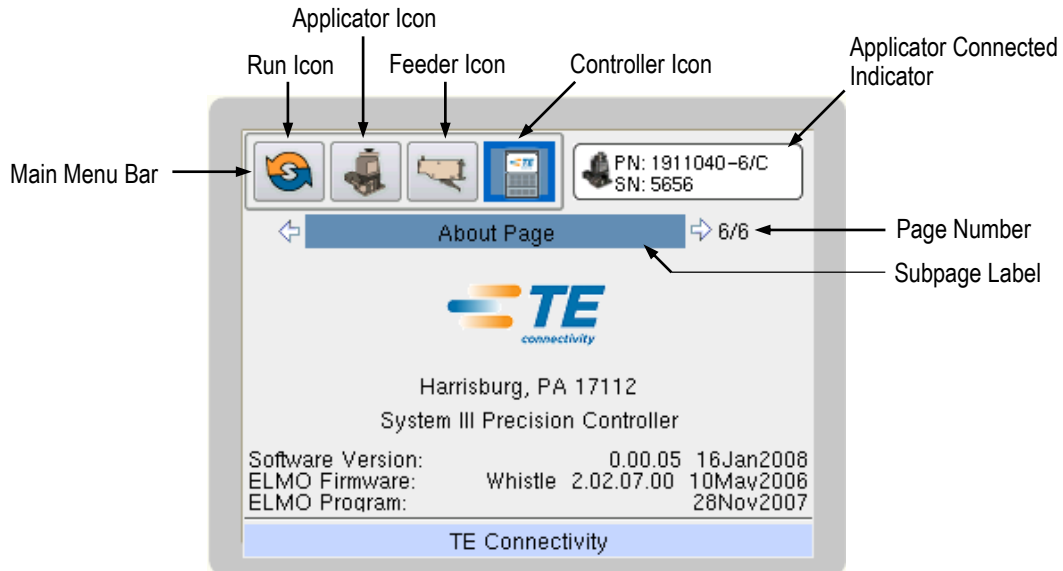

Figure 32

This screen is not a touch screen. It must be navigated using the controller screen navigation keys.

#### B. Controller Screen Navigation Keys

— Use the Up and Down navigation keys to move to and from the main menu bar and the screen entry fields. Also, use these keys to navigate inside pop-up selection boxes and spin boxes, such as “Terminal Selection” and “Trigger 1 Dwell”. See Figure 33.

— Use the Left and Right navigation keys to move through any subpages that are available for the currently displayed page.

**i NOTE** It will first be necessary to navigate down to the subpage label using the Up and Down navigation keys and then switch to the Left and Right navigation keys. Some pages do not have subpages. For example, Figure 32 shows that there are 5 subpages (6/6) to this particular screen.

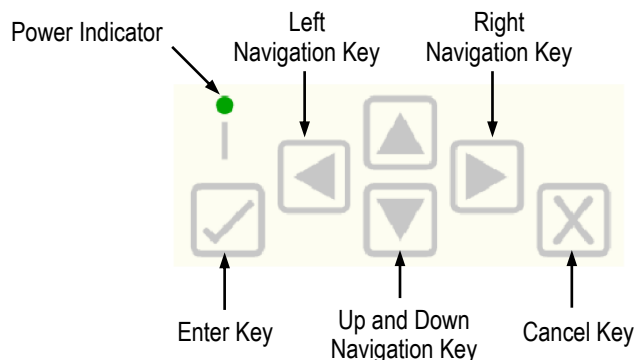

Figure 33

- Use the Enter key to enter fields, activate a highlighted pushbutton, and acknowledge message boxes and save changes.
- Use the Cancel key to cancel an operation and exit from some entry fields without saving data.



**NOTE**

Pressing the Cancel key repeatedly will exit any field return the user to the Run menu.

**C. Feeder Control Keys**

The Feeder Control keys and indicators are shown in Figure 34.

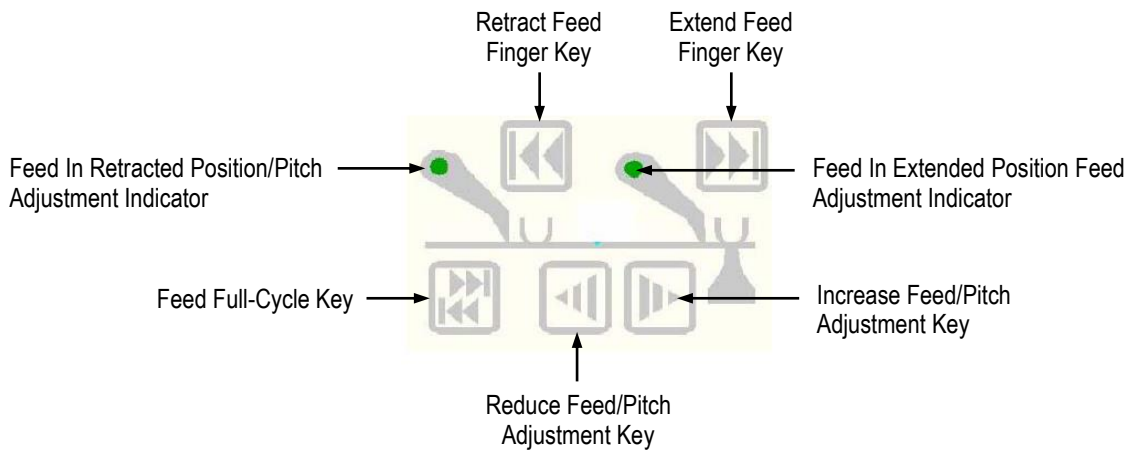

CONTROL KEY OR INDICATOR	DESCRIPTION
Retract Feed Finger Key	Pressing and holding this key moves (retracts) the feed to the programmed position.
Extend Feed Finger Key	Pressing and holding this key moves (extends) the feed to the programmed position.
Feed In Retracted Position/Pitch Adjustment Indicator	This indicator lights when the feed finger is retracted. In this position, the feed pitch may be adjusted. See Note 1.
Feed In Extended Position Feed Adjustment Indicator	This indicator lights when the feed finger is extended. In this position, the terminal feed position over the anvil may be adjusted. See Note 1 and Note 2.
Increase Feed/Pitch Adjustment Key	If at the feed in extended position, holding this key will extend the terminal feed position over the anvil. If at the feed retracted position, holding this key will shorten the feed pitch. Adjustments will be lost unless entered before using other Motion keys (except the Reduce Feed/Pitch Adjustment key.) Refer to Note 1.
Reduce Feed/Pitch Adjustment Key	This indicator lights when the feed finger is retracted. In this position, the feed pitch may be adjusted. See Note 1.
Feed Full-Cycle Key	Pressing and holding this key will run a complete (full) cycle at normal speed.

Note 1: When adjusting the terminal feed position over the anvil, the distance between the extended and retracted feed finger positions (the feed pitch) does not change. Therefore, changing the extended feed finger position automatically adjusts the retracted feed finger position by the same amount. When adjusting the feed pitch, the terminal feed position over the anvil does not change.

Note 2: The terminal position will not change when reducing the terminal feed position over the anvil. To see where the terminal will be located over the anvil, the terminal drag may be released and the strip retracted to contact the feed finger. Make sure to engage the terminal drag after completing the feed adjustment.

Figure 34

### 3.2. Feeder Calibration

1. Power up the controller. At this point, no applicator is connected and the screen will appear as shown in Figure 35.

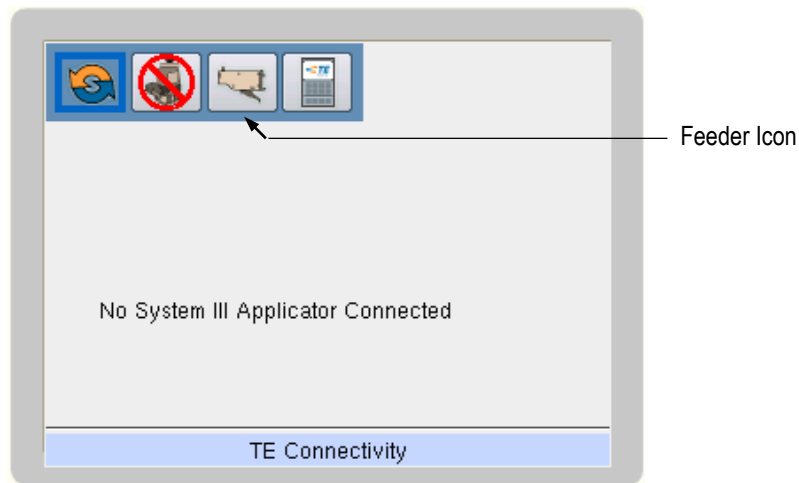
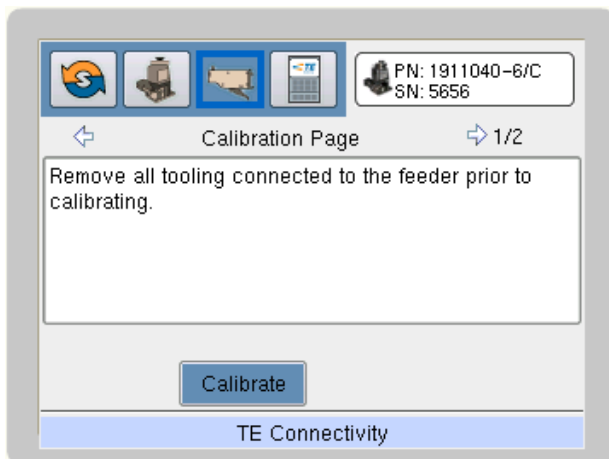

Figure 35

2. Use the Right navigation key to move to the Feeder icon on the main menu bar. See Figure 35.
3. Use the Down navigation key to move to the Calibrate pushbutton. See Figure 36.
4. Press the Enter key to begin the calibration. A progress bar at the bottom of the menu will appear to indicate this process has begun. See Figure 36.

**Calibrate Pushbutton**



**Progress Bar**

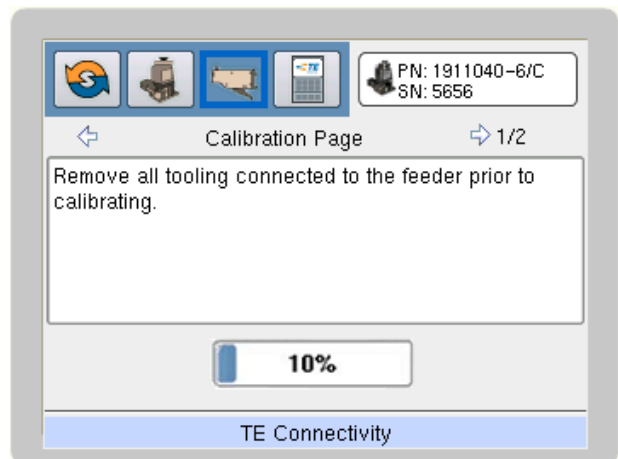

Figure 36

5. When the feeder has completed its necessary movements, the Apply and Abort pushbuttons will become visible. Install the calibration gage, and move the feeder by hand until it is in the gage position. See Figure 37.



**NOTE**

Use the Up and Down navigation keys to toggle between the "Apply" and "Abort".

6. When the appropriate pushbutton is highlighted, press the Enter key.  
After entering and saving the calibration changes, the screen shown in Figure 37 will appear. Select OK.



**Apply and Abort Pushbuttons**

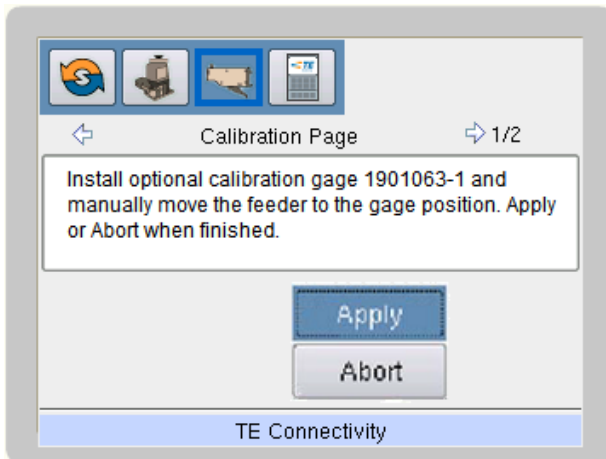

**Feeder Setup Complete**



Figure 37

### 3.3. I/O Interface Settings

1. Use the Right navigation key to move to the Precision Controller icon. See Figure 38.
2. To change the “Host Mode”, use the Down navigation arrow to move to the Host Mode field. Press the Enter key to enter the Host Mode selection field. See Figure 38.

A pop-up selection box will appear with choices available for selection. Use the Up and Down arrow keys to move within the selection box. Then save a selection by pressing the Enter key or cancel and exit by pressing the Cancel key.

**Precision Controller Icon**

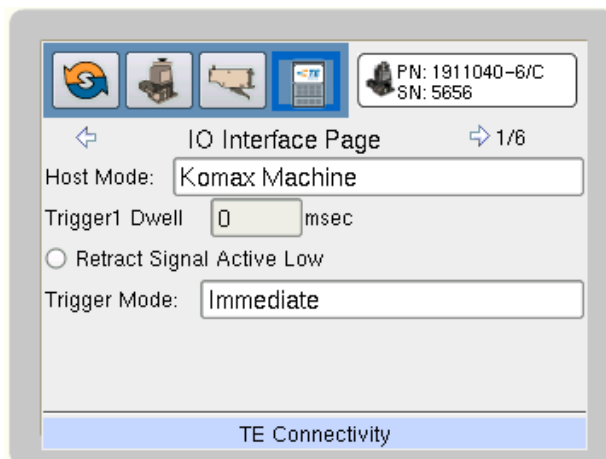

**Selection Box**

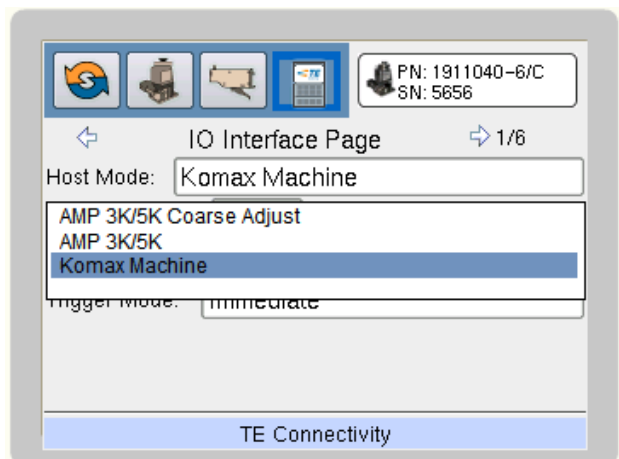

Figure 38

3. Use the Down navigation key to move to “Trigger1 Dwell”. See Figure 39. To change the value of the Trigger1 Dwell field:
  - a. Click the Enter key to enter the field.
  - b. Small Up and Down arrow keys will appear inside the field box for “Trigger1 Dwell”. See Figure 39. Use the arrow keys to increase or decrease the Trigger1 Dwell time.
  - c. To save or exit the field, use the Enter key to save or the Cancel key to cancel the change.

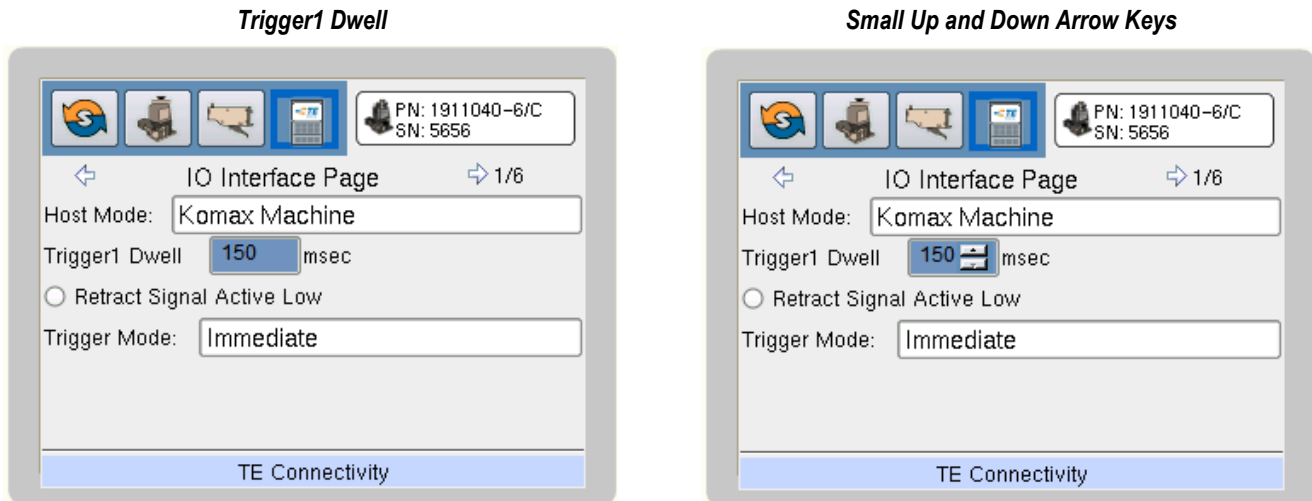

Figure 39



**NOTE**

Trigger1 dwell is the time period between receiving the Trigger1 signal (air feed from the host terminator) to when the feeder will start its cycle. If you experience timing problems between the terminator cycle and the feeder cycle, this value may be adjusted.

Certain terminators have different timings for the air feed signal; therefore, the Trigger1 dwell may have to be adjusted. It is recommended to start the feeder cycle when the terminator is at its lowest position (when it is crimping the terminal). As an example, a typical terminator cycle time around 300 msec is recommended. Therefore, a setting of 150 msec is a good starting point.

4. In the Host mode for the precision controller, the default setting is 0 msec. This assumes that the air feed signal on the Komax leadmaker is configured as follows (refer to Komax leadmaker documentation for the exact process):

Direction (up or down): actuates the air feed when the terminator is going up or down.  
For the precision controller, either setting is suitable.

Start of air feed from bottom-dead-center: range is 0.0 to 40 mm.  
For the precision controller, use a setting of 0 mm.

Actuation time: range is 100 to 1000 ms.  
For the precision controller, use a setting of 220 ms.

The settings for the Komax leadmaker integration should be set to:

HostMode = "Komax Machine"

TriggerMode = "Immediate"

TriggerDwellTime = "0"

TriggerActiveLow = "False"

### 3.4. Terminal Selection

1. Use the Up and Down navigation keys to move to the main menu bar, then use the Left or Right navigation keys to move to the Run icon. See Figure 40.



**NOTE**

Pressing the Cancel key repeatedly will exit any field and return the user to the Run menu.

2. Connect the feeder to a system III applicator. Approximately 10 seconds after the connection is made, the Run Screen icon will be displayed. The part number (PN:) and applicator serial number (SN:) will be displayed in the Applicator box located directly below the main menu bar. See Figure 40.

**Run Icon**

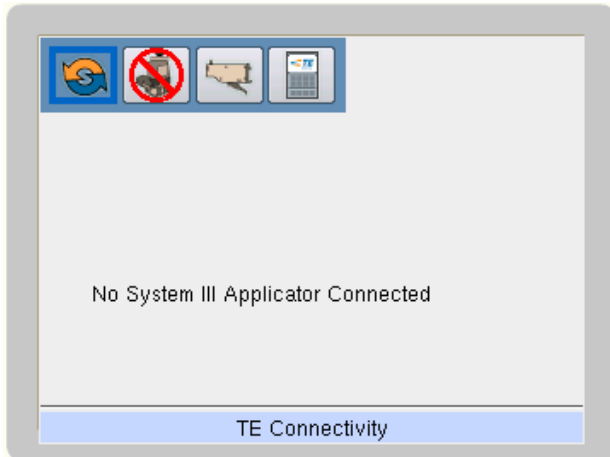

**Part Number and Serial Number in Applicator Box**

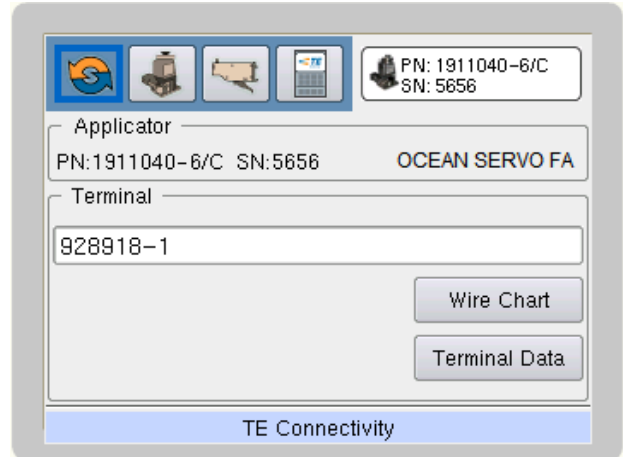
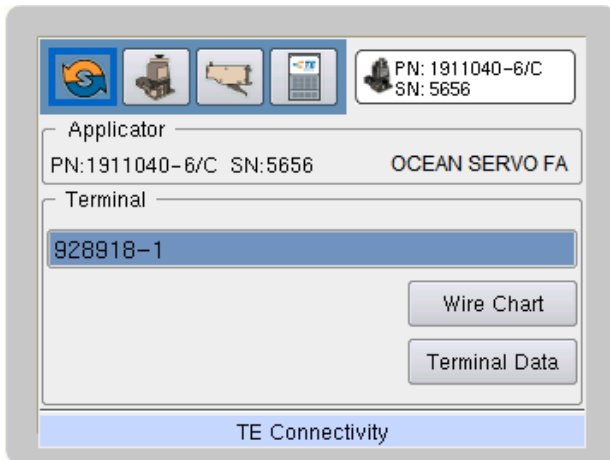

Figure 40

3. Use the Down navigation key to navigate to the Terminal field. See Figure 41.
4. Press the Enter key to enter the terminal selection field. See Figure 41. Scroll through the list using the Up and Down arrow keys. Select a terminal by moving to the desired terminal and pressing the Enter key. To cancel without selecting, press the Cancel key.

**Terminal Field**



**Terminal Selection Field**

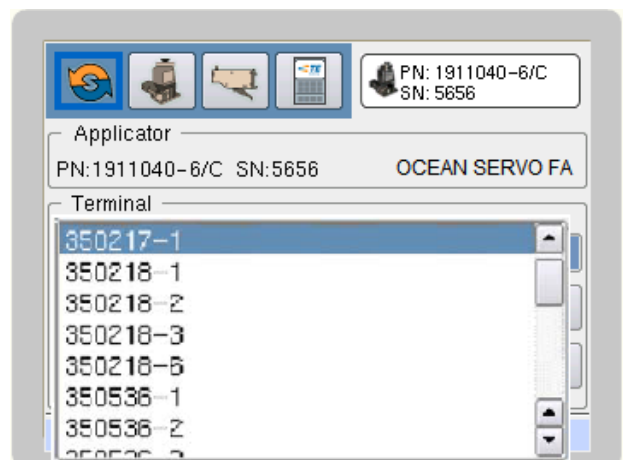

Figure 41

5. When a terminal is selected, the pop-up terminal list will disappear and the Run screen will be displayed with the selected terminal shown in the terminal box. See Figure 42.

**i** **NOTE**  
Any feeder positional changes saved will be associated with the displayed terminal.

6. After any terminal changes have been made, the feeder should be "homed". To home the feeder, press and hold the Extend Feed Finger key. The "home position" is the extend position that places the terminal over the applicator anvil for the next terminator cycle.

**i** **NOTE**  
When using the machine integration with the precision controller, the Komax leadmaker will select the terminal in the precision controller. When making adjustments of the feed position, make certain that the terminal is selected in the machine.

**Run Screen**

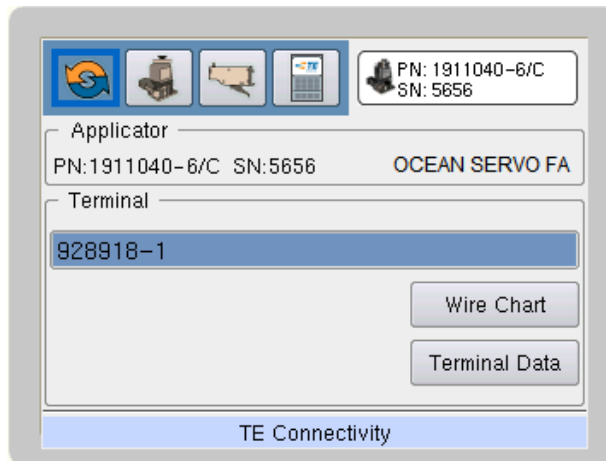

Figure 42

**3.5. Run Page Data**

**A. Run Page Wire Chart**

1. Use the Up and Down navigation keys to highlight the Wire Chart pushbutton (shown in Figure 42).

The Wire Chart screen will be displayed with wire gage and crimp height columns. If the host machine was set to "AMP 3K/5K Coarse Adjust", there will be a coarse adjust column containing the initial setting that is recommended. See Figure 43.

The Up and Down arrow keys can be used to scroll through the data.



**NOTE**

The Wire Chart screen is a "view only" screen. Information will not be reset or saved.

2. Press the Enter key. When the Wire Chart pushbutton is activated, a screen similar to the screen shown in Figure 43 will appear.

**Wire Chart Screen**

	Wire	Crimp Height	Coarse Adjust
1	14 AWG	1.75 mm / 0.069 "	W-8
2	16 AWG	1.5 mm / 0.059 "	X-1
3	18 AWG	1.32 mm / 0.052 "	X-2
4	20 AWG	1.19 mm / 0.047 "	X-4
5	2.0 mm <sup>2</sup>	1.7 mm / 0.067 "	W-9
6	1.5 mm <sup>2</sup>	1.57 mm / 0.062 "	X-0
7	1.25 mm <sup>2</sup>	1.45 mm / 0.057 "	X-1

**Terminal Data Screen (Ref)**

Data for terminal 350217-1	
	Value
Feed Finger ID	1901694-1
Application Specification	114-1011
Theoretical Crimp Width	2.29 mm / 0.09 "
Terminal Length	25.38 mm / 0.999 "
Minimum Strip Length	3.8 mm / 0.15 "
Maximum Strip Length	4.2 mm / 0.165 "

Figure 43

**B. Run Page Terminal Data**

1. Use the Up and Down navigation keys to highlight the Terminal Data pushbutton (shown in Figure 42).

- Press the Enter key. When the Terminal Data pushbutton is activated, a screen similar to the one shown in Figure 43 (Terminal Data screen) will appear. The Up and Down arrow keys can be used to scroll through the data. Data descriptions are given in Figure 44.

Serial Number:	serial number of the applicator assigned by TE (the serial number is unique for each applicator manufactured by TE)
Revision:	applicator revision assigned by TE
Applicator Name:	customer assigned name
Feed Finger ID:	feed finger part number
Application Specification:	application specification associated with the selected terminal
Theoretical Crimp Width:	theoretical crimp width of the terminal
Terminal Length:	length of the terminal from the tip of the crimped wire to the end of the terminal (this is used in certain leadmakers for machine positioning)
Minimum Strip Length:	terminal manufacturer's recommended minimum wire strip length
Maximum Strip Length:	terminal manufacturer's recommended maximum wire strip length
Feed Extend Position:	the feed finger extend position that places the terminal in the crimp tooling (this value is initially calculated but is easily changed and automatically saved when you adjust the feed extend position)
Feed Retract Position:	the feed retract position is the product feed pitch of the terminals (this value is initially calculated but is easily changed and automatically saved when you adjust the feed retract position)
Feed Rate:	manufacturer's set speed or motion profile for proper terminal feeding

Figure 44

### 3.6. Applicator Page Data

The Applicator page is accessed by way of the main menu bar using the Right and Left arrow keys to move to the Applicator icon. The applicator Terminal Data page looks exactly like the Run page (the difference being more operational). The Run page is used to select the terminal to run and view its data. This page is provided so that the user could view data for any terminal without changing the terminal that was selected to run.

The Applicator page consists of several subpages. Moving between pages is accomplished by moving to the subpage label and using the Right and Left arrow keys. In Figure 45, where the subpage label is highlighted, it is from this position that the Right and Left arrow keys can be used to switch between subpages.

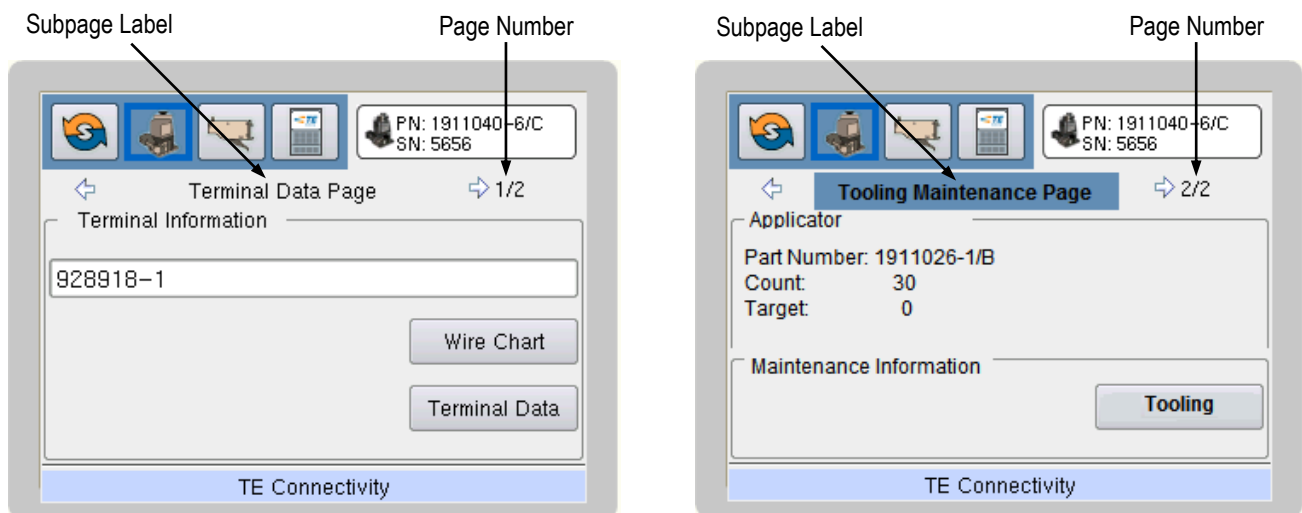

Figure 45

### A. Applicator Page Wire Chart

Selecting the Wire Chart pushbutton will access the screen shown in Figure 46.

Selecting the Terminal Data pushbutton will access the screen shown in Figure 46.

Data descriptions are given in Figure 44.

*Wire Chart Screen*

	Wire	Crimp Height
1	14 AWG	1.75 mm / 0.069 "
2	16 AWG	1.5 mm / 0.059 "
3	18 AWG	1.32 mm / 0.052 "
4	20 AWG	1.19 mm / 0.047 "
5	2.0 mm2	1.7 mm / 0.067 "
6	1.5 mm2	1.57 mm / 0.062 "

*Terminal Data Screen*

	Value
Feed Finger ID	1901694-1
Application Specification	114-1011
Theoretical Crimp Width	2.29 mm / 0.09 "
Terminal Length	25.38 mm / 0.999 "
Minimum Strip Length	3.8 mm / 0.15 "
Maximum Strip Length	4.2 mm / 0.165 "

Figure 46

### B. Tooling Maintenance Page

Page number 2 (2/2) of the Tooling Maintenance subpage displays maintenance information for the applicator that is connected. Maintenance information for the individual tooling parts is available by using the Tooling button shown in Figure 47, which displays the Tooling screen shown in Figure 47. This screen contains information on individual pieces of tooling.

*Tooling Button*

PN: 1911040-6/C  
SN: 5856

← **Tooling Maintenance Page** → 2/2

Applicator  
Part Number: 1911026-1/B  
Count: 30  
Target: 0

Maintenance Information

**Tooling**

TE Connectivity

*Tooling Screen*

	Tool	Part Number	Count	Target
1	Wire Crimper	3-456406-3	30	0
2	Ins Crimper	456134-5	30	0
3	Anvil	1338694-5	30	0
4	Fr Shear	454276-1	30	0
5	Fr Shear H Cut	1320921-1	30	0

Figure 47

Data descriptions are as follows:

- Tool: manufacturer's description of the tool
- Part Number: manufacturer's part number of the tool
- Count: number of cycles on the tool
- Target: customer entered number of cycles for service warning



**NOTE**

The maintenance tools are programmed initially by TE. There are no provisions on the precision controller to edit this data or service the tools when targets are reached. To utilize these advanced features, obtain system III applicator support kit 976700-1; also known as system III data management software (system III DMS).

The kit includes a CD containing a Windows utility, probe assembly for attachment to the applicator memory device, and USB adapter to connect to a customer-supplied PC. Additional information can be obtained from the tooling assistance center by calling 1-800-722-1111.

**3.7. Feeder Data**

The Feeder page is accessed by using the Right and Left navigation keys in the main menu bar to move to the Feeder icon shown in Figure 48.

The Feeder page consists of several subpages. Moving between pages is accomplished by moving to the subpage label, and clicking the Right and Left arrow keys.

**A. Calibration Page**

The Calibration page is shown in Figure 48. Refer to Paragraph 3.2, Feeder Calibration, for description.

**B. Maintenance Page**

This page displays the maintenance information including the cycle count and feeder ID (unique identifier of the feeder.) See Figure 48.

The maintenance page also has a grayed out Maintenance Completed pushbutton that will become active when feeder maintenance is required. A pop-up message will appear on the screen when the feeder requires maintenance. After the maintenance is performed, the user can activate the "Maintenance Completed" pushbutton. This will reset the feeder counts and eliminate any further feeder maintenance messages until the feeder again requires maintenance.

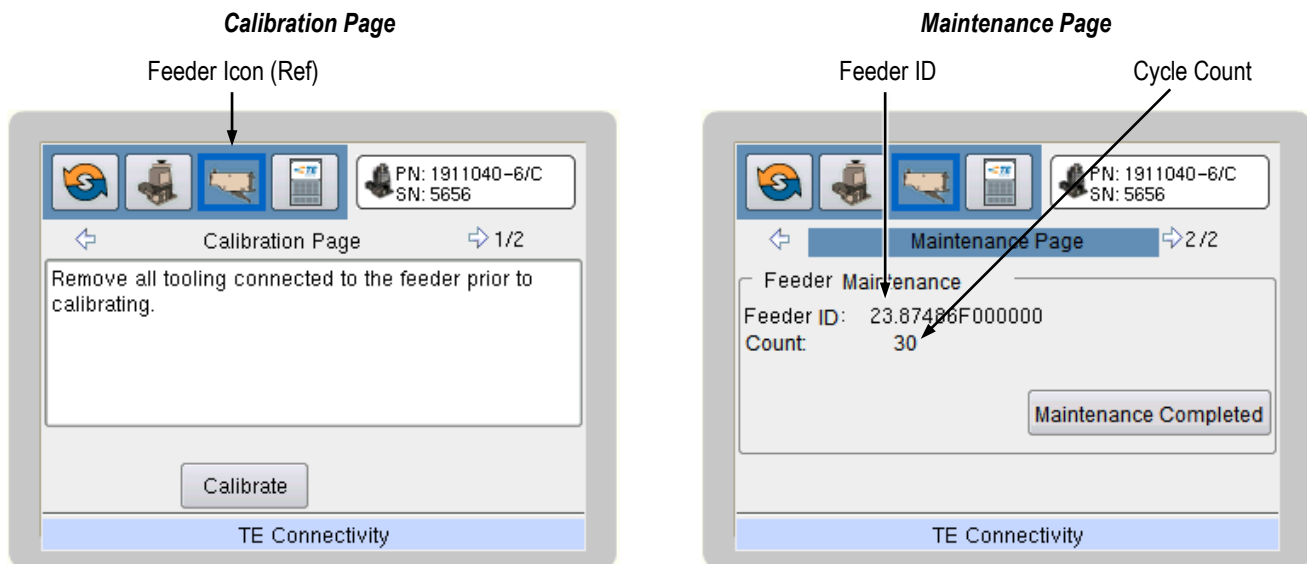

Figure 48

**3.8. Precision Controller**

**A. I/O Interface Page**

The I/O Interface page is accessed by using the Right and Left navigation keys in the main menu bar to move to the I/O Interface icon (shown in Figure 49). Refer to Paragraph 3.3, I/O Interface Settings, for details.

**B. Digital I/O Page**

This page displays the status of all inputs and outputs on the precision controller.

The Up and Down navigation keys can be used to navigate down the right side of the screen to any of the outputs. Pressing the Enter key on any of the outputs will cause the output to toggle to the opposite state as depicted by the light next to the output. All outputs should be displayed as off and only the “Servo Safety Status” input should be displayed as on. Refer to Figure 49.

### C. Analog I/O Page

This page displays the serial numbers of the one-wire devices for the feeder and applicator. The “Elmo drive temperature” is displayed in degrees Celsius. See Figure 49.

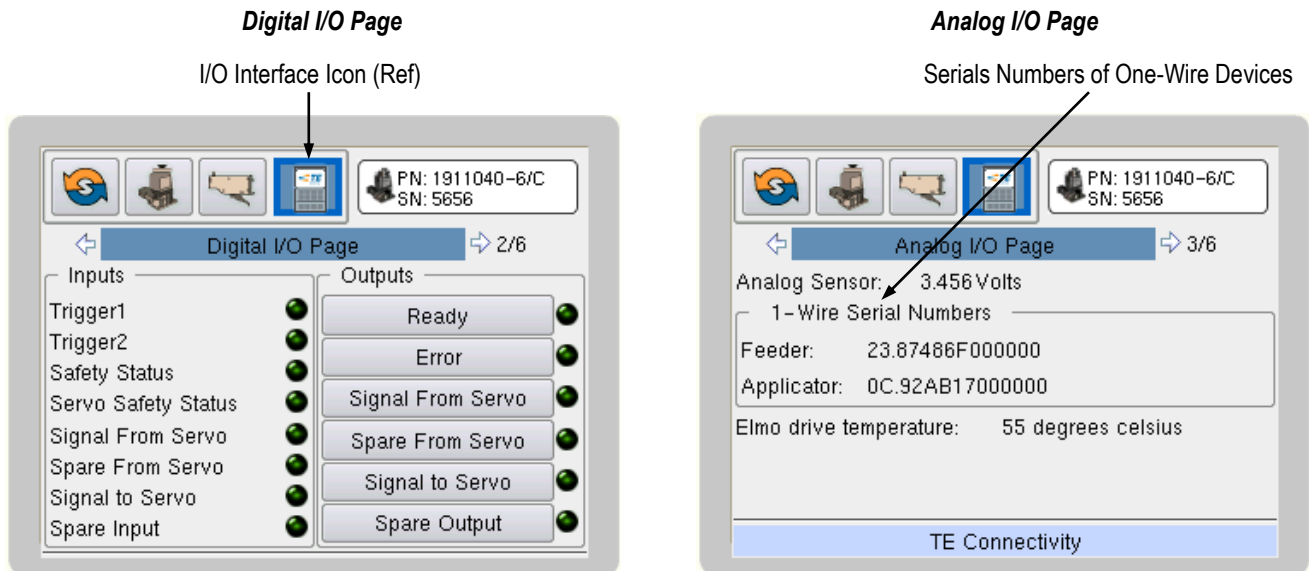

Figure 49

### D. Settings Page

On this page, the language can be changed by moving to the Language Edit field using the Up and Down arrow keys and then pressing the Enter key. A pop-up selection box will appear, the user can scroll to the appropriate language and press the Enter key to select it. Ethernet settings are used for TE internal use and typically should be left alone. See Figure 50.

LCD calibration is typically only done at manufacturing time and should not be changed. If a user inadvertently enters the calibration routine, the Cancel key can be pressed several times, and it will exit out of the Calibration mode.

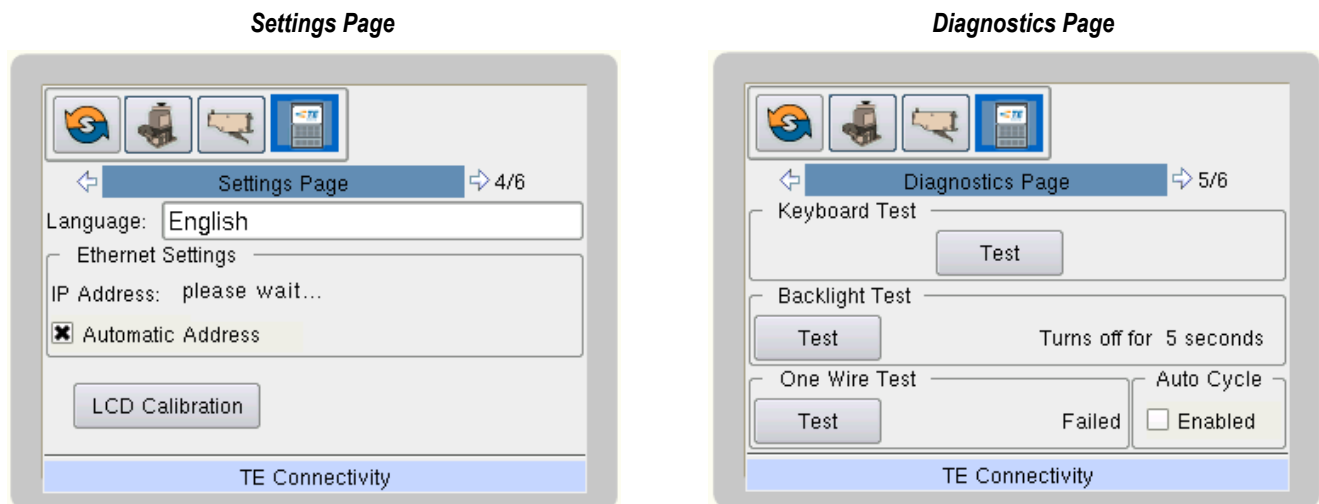

Figure 50



### E. Diagnostics Page

The diagnostics page is used to test several of the systems on the precision controller. The keyboard, backlight, and one-wire communications can be tested. Use the Up and Down navigation keys to move to the appropriate Test pushbutton, and then use the Enter key to enter or begin the test. See Figure 50.

The “Keyboard Test” shown in Figure 51 allows the user to test the keypad keys. To get to the keyboard test, several keys will already have to work and it will be quite noticeable if they do not.

Use the Left or Right navigation key to get to the Precision Controller menu.

The Up and Down arrow keys will be required to get to the subpage label and then to the Test pushbutton. The Enter key must be pressed to enter the test. It will become quite obvious if any of these keys do not work.

After the user enters the keyboard test, the screen shown in Figure 51 will be displayed. The user can test each key by pressing it. *Press the Enter key last.* Pressing “Enter” exits the keyboard test. As each key is pressed, its image is displayed on the screen.

When the user enters the “Backlight Test”, the backlight will turn off for approximately five seconds and then turn back on.

As soon as the user enters the “One Wire Test”, the Test pushbutton will become greyed out (inactive) as shown in Figure 51. The text on the far right will change to display the status as "Testing".

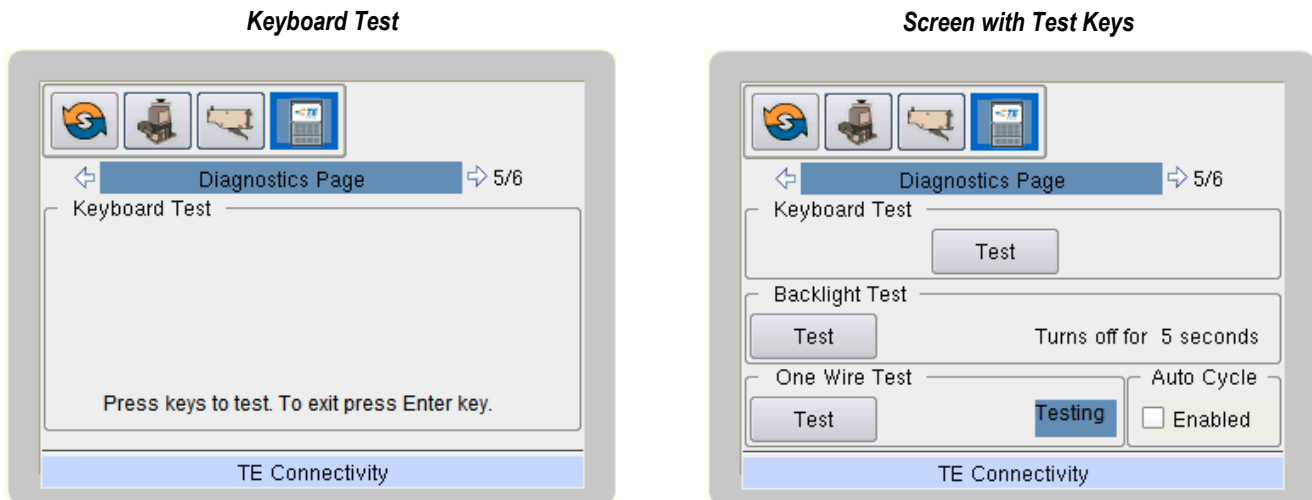

Figure 51

After the test is completed, its status will change to “PASSED” or “FAIL”. See Figure 52.

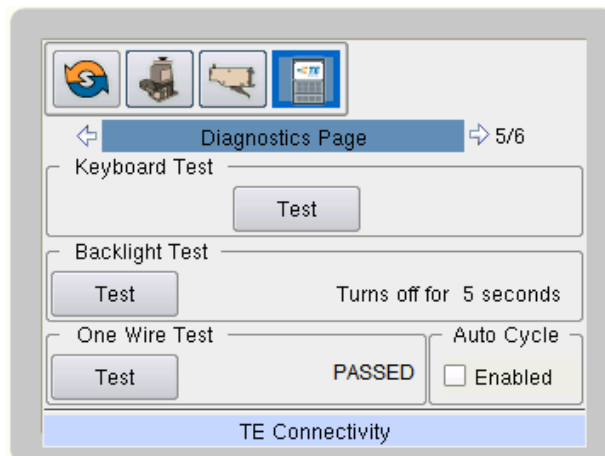

Figure 52

## F. About Page

The “About Page” displays the version of the various software and firmware programs in the unit. This can be useful to identify the current versions of software and determine if an upgrade is needed. See Figure 53.

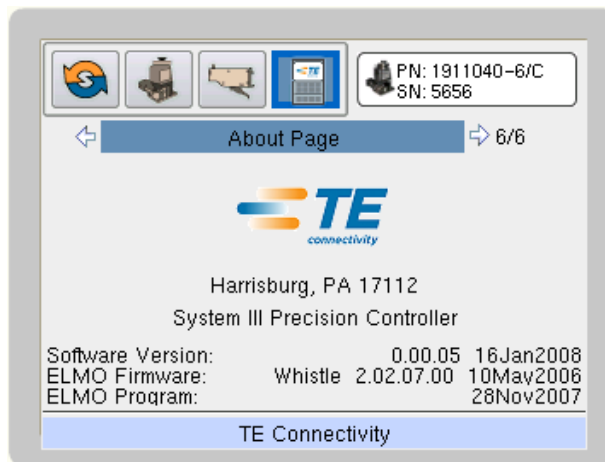

Figure 53

## 4. SYSTEM III TERMINAL SERVO FEEDER OPERATION AND CALIBRATION

### 4.1. Feeder Operation

1. Attach the appropriate feed finger to the terminal feeder using the quick-release pin.



#### NOTE

The required feed finger is identified on the applicator identification tag and in the data storage device on the applicator (the data can be displayed through the software in the system III precision controller).

Figure 54 shows the side feed finger assembly and the end feed finger assembly. The side feed finger features a replaceable tip that can be flipped over to provide an additional feed tip. Note the orientation of the quick-release pin (shown in Figure 54).

*Side Feed Finger Assembly*



Quick-Release Pin

*End Feed Finger Assembly*

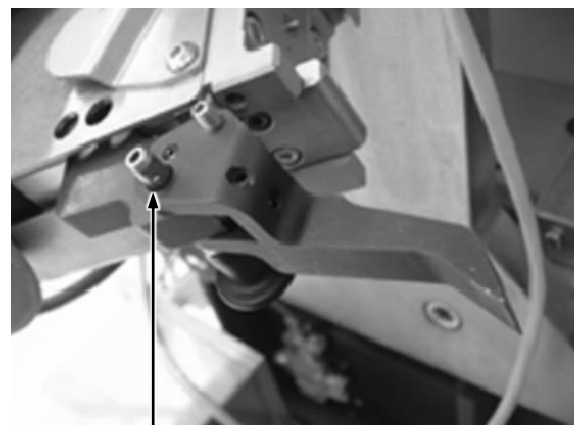

Quick-Release Pin

Figure 54

2. Flip the side feed finger into the up position. A spring-loaded detent will hold it in place.
3. Install the feeder into the applicator as shown in Figure 55. Flip the feed finger down. For a side-feed applicator, make sure that the feed finger is positioned in the feed track groove. See Figure 55.



**NOTE**

The feeder may be installed with the terminal strip loaded as shown in Figure 56.

*Installing Feeder into Applicator*

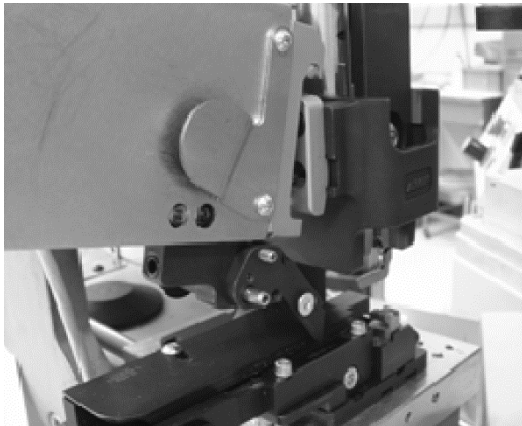

*Feed Finger in Feed Track Groove (Side-Feed Applicator)*

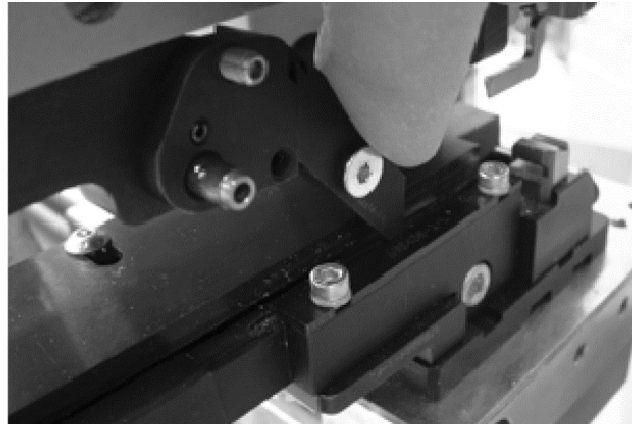

Figure 55

Terminal Strip

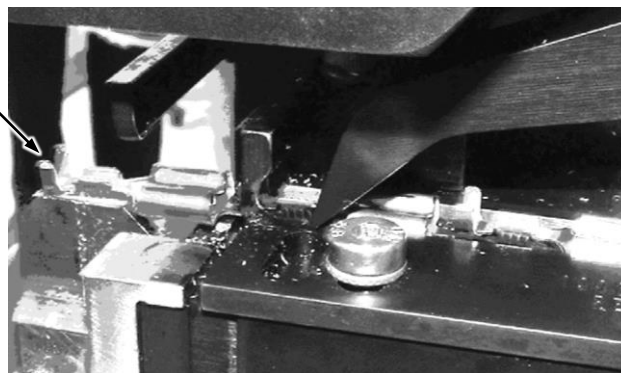

Figure 56

4. Load the applicator (with the feeder attached) into the terminator, and close the guard door.
5. After the feeder is attached, data will be uploaded from or downloaded to the applicator. Removal of the feeder unit during uploading or downloading data will result in an error and lost data. Therefore, wait until the "Reading Information from Applicator" message disappears from the display.

The Extend Feed Finger key (shown in Figure 34) must be held until the Feed In Extended Position indicator (shown in Figure 34) lights before a crimp cycle is triggered.

#### 4.2. Feeder Calibration

1. Disconnect the feeder from the applicator, and remove the feed finger.



**DANGER**

To prevent personal injury, keep fingers clear of the feed finger. The next step **will** cause motion.

2. Select "Calibrate" from the Feeder Page screen. When prompted, install the feeder calibration gage. See Figure 57.
3. Make sure that the gage block (flag) is tight against the side as shown in Figure 57 and tight against the step of the feeder mounting bracket. Failure to consistently install the feeder block will result in inaccurate feed position between feed units.

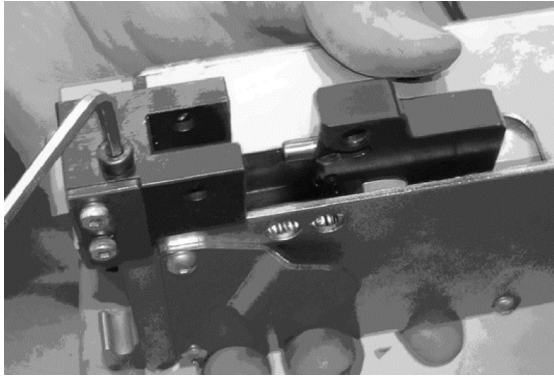
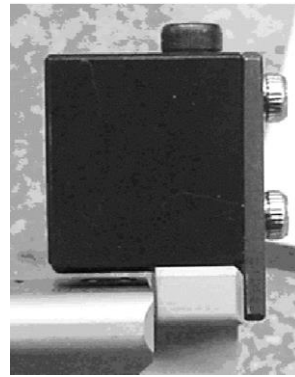
**Feeder Calibration Gage***Figure 57***Gage Block Position**

4. If the feed arm does not enter the gage block as shown in Figure 58, loosen the four latch plate screws as shown in Figure 58, and move the latch plate.

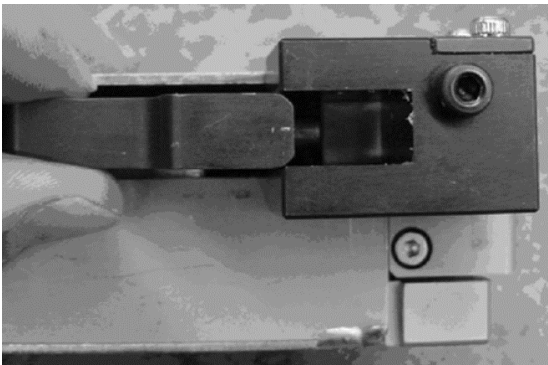
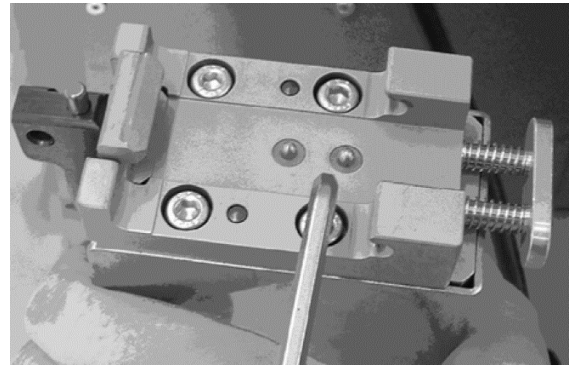
**Feed Arm Does Not Enter Gage Block****Four Latch Plate Screws***Figure 58*

5. Install the quick-release pin through the gage block and feed arm. If the quick-release pin does not pass completely through the feed arm, loosen feed arm screws as shown in Figure 59, and move the feed arm.

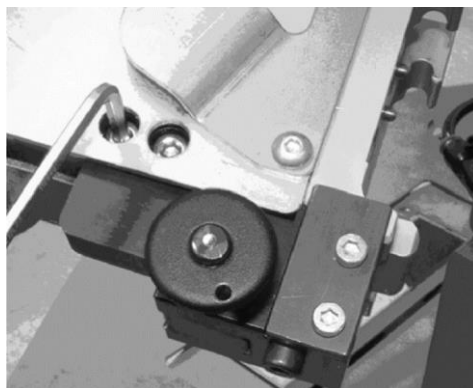
*Figure 59*

6. Re-tighten all the loose hardware.
7. Select the Apply button in the Feeder Page screen.
8. Remove the calibration assembly.

## 5. TERMINATION QUALITY

Many of the problems that arise during machine usage are the result of improper adjustments rather than machine malfunctions. These problems will generally manifest themselves as one of the poor quality terminations shown in Figure 60.

### Side-Feed Terminals

*Terminated Correctly*



*Terminations Unacceptable with Causes  
(Result of Poorly Adjusted Applicator)*

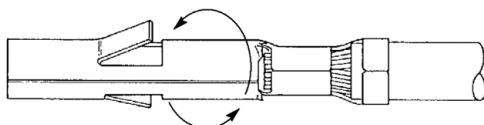
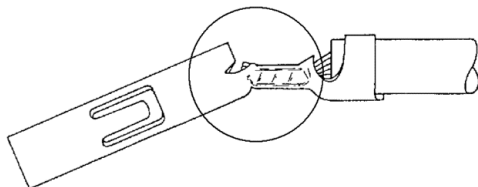
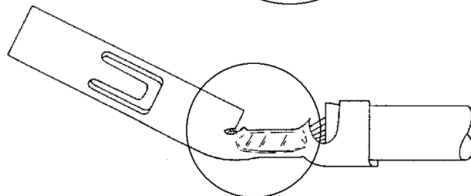
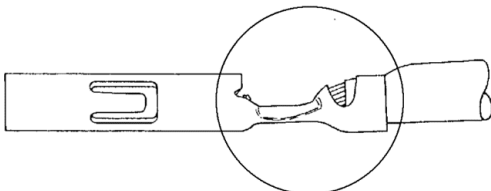
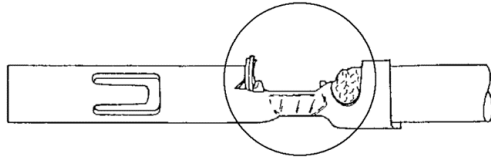
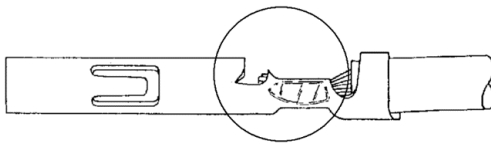

Wire strands must be visible anywhere in this area.

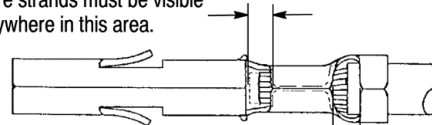

Wire strands and insulation must both be visible anywhere in this area.

Wire strands must not extend above this plane.

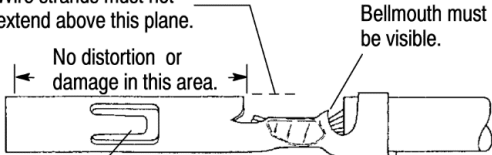

Bellmouth must be visible.

No distortion or damage in this area.

Locking lances not deformed.

Cutoff tab must be visible.

Bellmouth on wrong end of wire barrel — long cutoff tab.  
CAUSE: Strip guide plate screw out of adjustment.

Wire located too far through wire barrel.  
CAUSE: Too long strip length. Incorrect wire protrusion at applicator.

Large bellmouth — no cutoff tab.  
CAUSE: Incorrectly adjusted strip guide plate screw. Incorrect wire and insulation disk settings. Wrong terminal in applicator.

Terminal bent upward.  
CAUSE: Incorrectly adjusted terminal holddown.

Terminal bent downward.  
CAUSE: Damaged or worn tooling. Lack of terminal lubrication (metals such as gold, nickel, silver, and steel require lubrication for termination).

Terminal twisted.  
CAUSE: Feed problem. Terminal either overfed or underfed.

Figure 60 (Cont'd)

**End-Feed Terminals**

Terminated Correctly

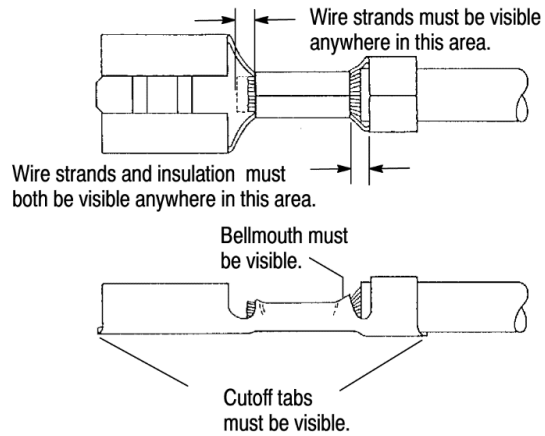
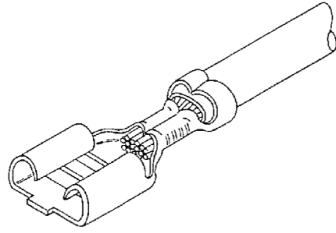

Terminations Unacceptable with Causes  
(Result of Poorly Adjusted Applicator)

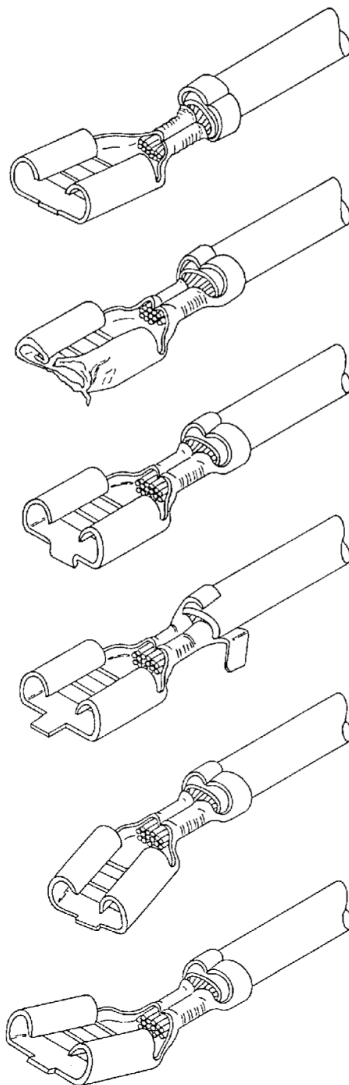

Terminal twisted.  
CAUSE: Strip guides not properly aligned.

Front of terminal cut off; bellmouth on wrong end of wire barrel.  
CAUSE: Feed problem. Terminal not fed far enough.

Front cutoff tab not sheared properly.  
CAUSE: Damaged front shear plate, loose tooling, incorrect tooling, damaged shear blade, or damaged slug blade.

Rear of terminal deformed, long front cutoff tab, large bellmouth.  
CAUSE: Feed problem. Terminal fed too far.

Terminal bent downward.  
CAUSE: Damaged or worn tooling. Lack of terminal lubrication (metals such as gold, nickel, silver, and steel require lubrication for termination).

Terminal bent upward.  
CAUSE: Terminal holddown missing. Broken holddown spring.

Figure 60 (Cont'd)

**Typical Good Termination**

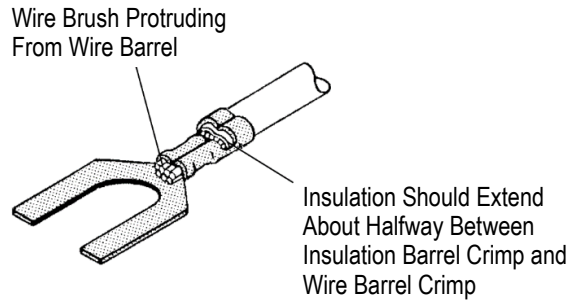

**Poor Terminations  
(Result of Improper Machine Adjustments)**

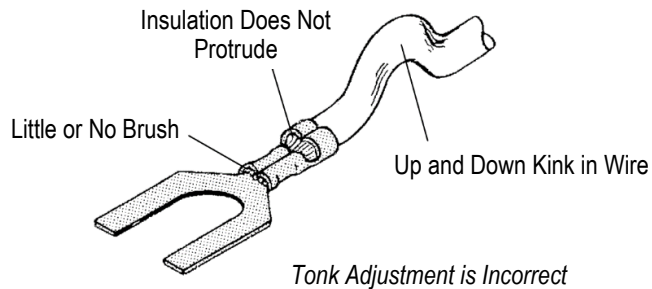
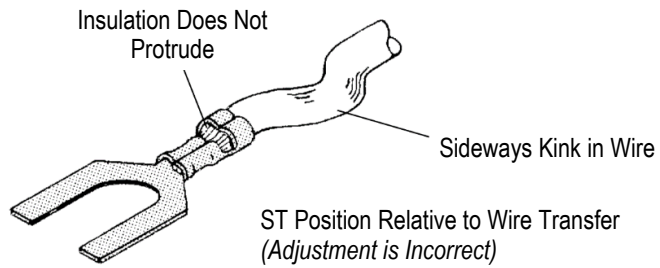
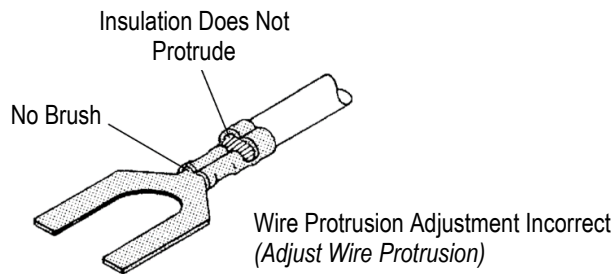

Figure 60 (End)

## 6. MAINTENANCE

### 6.1. Normal Preventive Maintenance and Lubrication

Follow the instructions given in the respective machine manuals.

### 6.2. System III Feeder Maintenance

#### A. One Million Cycles of Feeder Operation

Every one million cycles of feeder operation, perform the following recommended preventive maintenance procedures:

1. Remove electrical power from the machine.
2. Disassemble the rear guard cover, and remove the feeder guard.
3. Clean any accumulated debris from the ball screw and linear rails.
4. Inspect for any damaged parts or excessive bearing clearance.
5. Lightly lubricate ball screw and linear rails with lithium EP NLGI No. 2 grease. Refer to Figure 61.
6. Apply light machine oil to feed arm plunger and pivot hole. Refer to Figure 61.

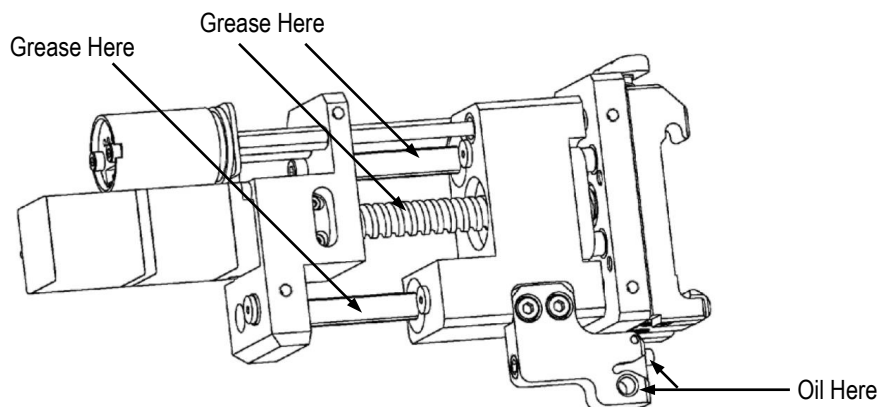

Figure 61

7. Re-install the guards, and calibrate feeder.



#### **DANGER**

*To avoid personal injury, the feeder should not be operated without guards in place. The feeder guard is an integral structural element required for proper function of feeder.*

#### B. Ten Million Cycles of Feeder Operation

Every ten million cycles of feeder operation, perform the following recommended preventive maintenance procedures:

1. Disconnect electrical power from the machine.
2. Dis-assemble the rear guard cover, and remove the feeder guard.
3. Loosen the coupler clamp screws, and remove the servo motor.
4. Remove the coupler from the servo motor, and install a new coupler. Note that the coupler set-up dimension is given on the assembly drawing.
5. Re-assemble the servo motor, and tighten the remaining coupler screws.
6. Reassemble guards, and calibrate feeder.
7. Connect power.



Troubleshoot the feeder as described in Figure 62.

PROBLEM	PROBABLE CAUSE	REMEDY
Feeder does not read data correctly.	Dirt shorting out applicator memory.	Remove memory and clean.
	Feeder removed before data transfer is complete.	Reconnect and allow time for the displayed message on the machine to close.
Feed finger does not align with track.	Mis-adjustment of feeder amount bracket.	Loosen bracket then install feeder moving assembly until the feed finger aligns correctly. Carefully remove feeder and tighten mounting hardware.
Terminal feed position changes between terminators/machines.	Calibration not performed exactly the same between machines.	Perform feeder calibration on both machines.
Terminals is not being properly fed.	Retract position is set too short.	Adjust retract position until feed finger properly picks up feed index hole. May need to test feed at speed.

Figure 62

### 6.3. Clearing Jammed Terminal Strip

1. Turn off the power to the system III precision controller.



**DANGER**

*Make sure to turn off the system III precision controller (in addition to powering down the bench top terminator or leadmaker) prior to clearing a jam. Otherwise, injury is possible.*

2. Clear the jam (refer to the respective machine customer manual).
3. Turn the system III precision controller back on.
4. Position the terminal over the anvil.
5. Resume production.

### 6.4. Precision Controller Maintenance

There are no serviceable components in the precision controller. If the unit fails, contact Tooling Assistance Center at 1-800-722-1111 for troubleshooting assistance or information regarding the component repair center.



**DANGER**

*Under the right conditions, the servo drive controller in the precision controller will reach a temperature capable of causing burns. Do not open the controller.*

## 7. RESTRICTION ON HAZARDOUS SUBSTANCES (RoHS) INFORMATION

Information on the presence and location of any substances subject to RoHS can be found at <http://www.te.com/customer-support/rohssupportcenter>

Click the Resources tab, click Check Product Compliance, enter the terminator part number then click “Search”.

## 8. REVISION SUMMARY

Revisions to this customer manual include:

- Modified step 1 of Paragraph 2.3 and step 1 of Paragraph 2.3, A
- Updated search information in Section 7