

SAC Series

Axial Leaded – 500W



Additional Information



Resources



Accessories



Samples

Agency Approvals

Agency	Agency File Number
	E230531

Maximum Ratings and Thermal Characteristics

($T_A=25^{\circ}\text{C}$ unless otherwise noted)

Parameter	Symbol	Value	Unit
Peak Pulse Power Dissipation by 10/1000 μs Test Waveform (Fig.1) (Note 1)	P_{PPM}	500	W
Steady State Power Dissipation on Infinite Heat Sink at $T_L=75^{\circ}\text{C}$	P_D	3.0	W
Operating Junction and Storage Temperature Range	T_J, T_{STG}	-65 to 175	$^{\circ}\text{C}$
Typical Thermal Resistance Junction to Lead	$R_{\theta\text{JL}}$	20	$^{\circ}\text{C}/\text{W}$
Typical Thermal Resistance Junction to Ambient	$R_{\theta\text{JA}}$	75	$^{\circ}\text{C}/\text{W}$

Note:

1. Non-repetitive current pulse, per Fig. 3 and derated above T_J (initial) = 25°C per Fig. 2.

Description

The SAC Series is designed specifically to protect sensitive electronic equipment from voltage transients induced by lightning and other transient voltage events.

Features & Benefits

- 500W peak pulse power capability at 10/1000 μs waveform, repetition rate (duty cycles):0.01%
- Glass passivated chip junction in DO-15 Package
- Fast response time: typically less than 1.0ps from 0 Volts to BV min
- Typical failure mode is short from over-specified voltage or current
- Whisker test is conducted based on JEDECJESD201A per its table 4a and 4c
- IEC-61000-4-2 ESD 30kV(Air), 30kV (Contact)
- ESD protection of data lines in accordance with IEC 61000-4-2
- Low incremental surge resistance
- EFT protection of data lines in accordance with IEC 61000-4-4
- High temperature to reflow soldering guaranteed: 260 $^{\circ}\text{C}/30\text{sec}$ / 0.375"/(9.5mm) lead length, 5 lbs., (2.3kg) tension
- Plastic package is flammability rated V-0 per Underwriters Laboratories
- Matte tin lead-free plated
- Ideal for data line applications
- Halogen free and RoHS compliant
- Pb-free E3 means 2nd level interconnect is Pb-free and the terminal finish material is tin(Sn) (IPC/JEDEC J-STD-609A.01)

Applications

TVS devices are ideal for the protection of I/O interfaces, VCC bus and other vulnerable circuits used in telecom, computer, industrial and consumer electronic applications.

Schematic

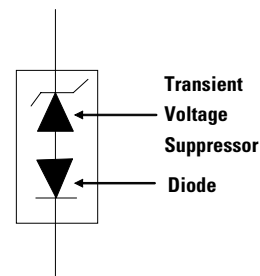

SAC Series

Axial Leaded – 500W

Electrical Characteristics ($T_A=25^\circ\text{C}$ unless otherwise noted)

Part Number	Reverse Stand off Voltage V_R (V)	Breakdown Voltage V_{BR} (V)		Maximum Reverse Leakage $I_R @ V_R$ (μA)	Maximum Clamping Voltage $V_C @ I_{PP}$ (V)	Maximum Peak Pulse Current (Fig.3) I_{PP} (A)	Maximum Junction Capacitance @ 0Volts (pF)	Working Inverse Blocking Voltage V_{WIB} (V)	Inverse Blocking Leakage Current at I_{IB} @ V_{WIB} (mA)	Peak Inverse Blocking Voltage V_{PIB} (V)	Agency Approval 
		MIN	MAX								
SAC5.0	5.0	7.6	8.3	300	13.2	46.2	50	700	1	800	X
SAC6.0	6.0	7.9	9.3	300	12.2	43.1	50	700	1	800	X
SAC7.0	7.0	8.3	10.5	300	13.7	39.9	50	700	1	800	X
SAC8.0	8.0	8.9	10.9	100	13.9	37.8	50	700	1	800	X
SAC8.5	8.5	9.4	11.5	50	14.7	35.7	50	700	1	800	X
SAC10	10	11.1	13.6	5	17.2	30.5	50	700	1	800	X
SAC12	12	13.3	16.3	1	20.0	26.3	50	700	1	800	X
SAC15	15	16.7	20.4	1	25.0	21.0	50	700	1	800	X
SAC18	18	20.0	24.4	1	33.3	15.8	50	700	1	800	X
SAC22	22	24.4	29.8	1	35.7	14.7	50	700	1	800	X
SAC26	26	28.9	35.3	1	45.0	11.7	50	700	1	800	X
SAC30	30	33.3	41.1	1	50.0	10.5	50	700	1	800	X
SAC36	36	40.0	48.9	1	58.1	9.0	50	700	1	800	X
SAC45	45	50.0	61.1	1	73.5	7.1	50	700	1	800	X
SAC50	50	55.5	66.6	1	86.2	6.1	50	700	1	800	X
SAC55	55	60.5	66.9	1	87.0	5.7	50	700	1	800	X
SAC60	60	66.0	72.9	1	95.0	5.3	50	700	1	800	X
SAC65	65	71.5	79.0	1	103.0	4.9	50	700	1	800	X
SAC70	70	77.0	85.1	1	111.0	4.5	50	700	1	800	X
SAC75	75	82.5	91.2	1	119.0	4.2	50	700	1	800	X
SAC80	80	88.0	97.2	1	127.0	3.9	50	700	1	800	X
SAC85	85	93.5	103.3	1	135.0	3.7	45	700	1	800	X
SAC90	90	99.0	109.4	1	143.0	3.5	45	700	1	800	X
SAC95	95	104.5	115.5	1	151.0	3.3	45	700	1	800	X
SAC100	100	110.0	121.0	1	158.0	3.2	40	700	1	800	X
SAC110	110	120.0	133.0	1	173.0	2.9	40	700	1	800	X
SAC120	120	131.0	145.0	1	189.0	2.6	40	700	1	800	X
SAC130	130	142.0	160.0	1	209.0	2.4	35	700	1	800	X
SAC140	140	153.0	170.0	1	219.0	2.3	35	700	1	800	X
SAC150	150	164.0	182.0	1	237.0	2.1	35	700	1	800	X

SAC Series

Axial Leaded – 500W

Ratings and Characteristic Curves ($T_A=25^\circ\text{C}$ unless otherwise noted)

Figure 1:
Peak Pulse Power Rating Curve

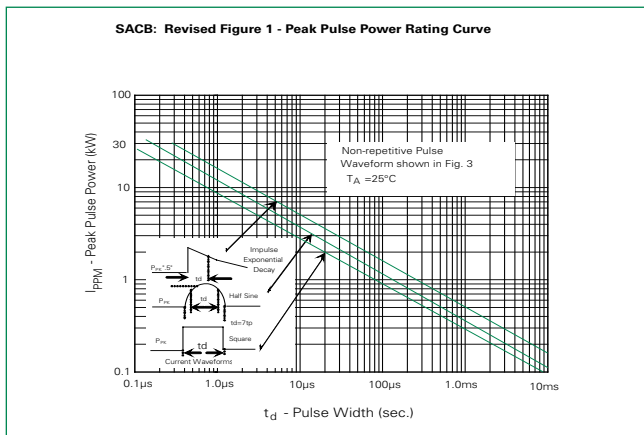

Figure 2:
Peak Pulse Power Derating Curve

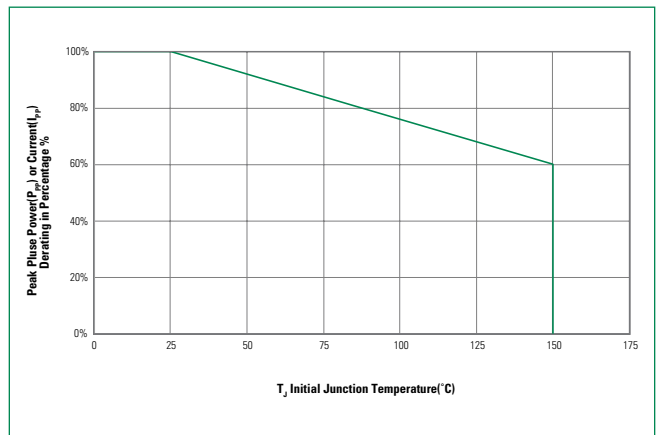

Figure 3:
Pulse Waveform

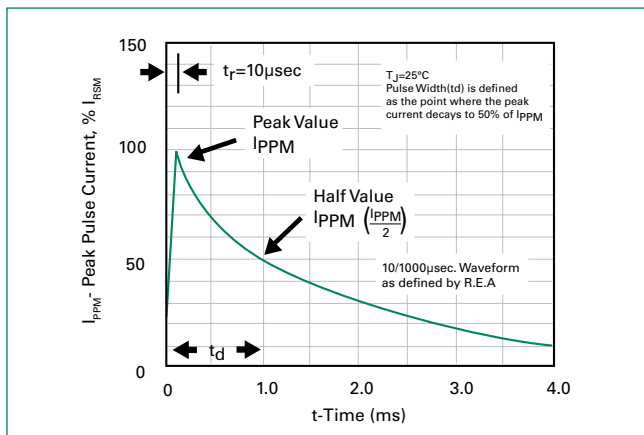
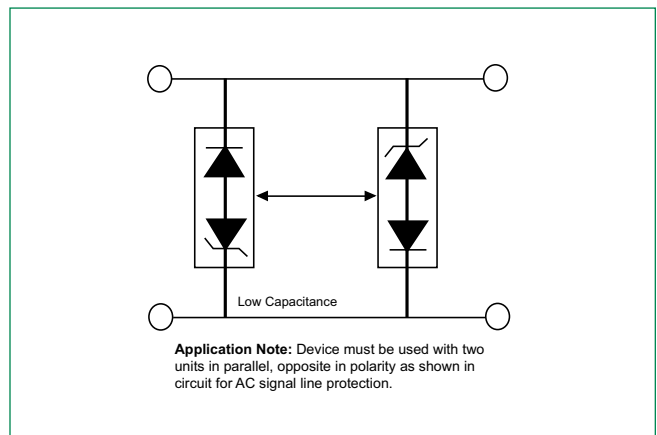

Figure 4:
AC Line Protection Application



SAC Series

Axial Leaded – 500W

Soldering Parameters

Reflow Condition		Lead-free assembly
Pre Heat	- Temperature Min ($T_{s(min)}$)	150°C
	- Temperature Max ($T_{s(max)}$)	200°C
	- Time (min to max) (t_s)	60 – 120 secs
Average ramp up rate (Liquidus Temp (T_A) to peak)		3°C/second max
$T_{s(max)}$ to T_A - Ramp-up Rate		3°C/second max
Reflow	- Temperature (T_A) (Liquidus)	217°C
	- Time (min to max) (t_s)	60 – 150 seconds
Peak Temperature (T_p)		260 ^{+0/-5} °C
Time within 5°C of actual peak Temperature (t_p)		30 seconds max
Ramp-down Rate		6°C/second max
Time 25°C to peak Temperature (T_p)		8 minutes Max.
Do not exceed		260°C

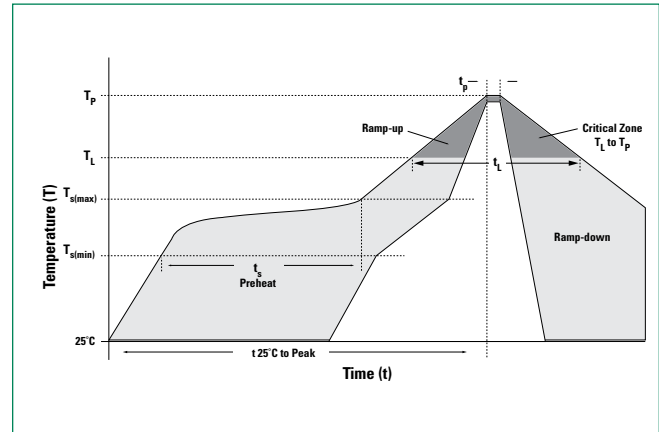

Flow/Wave Soldering (Solder Dipping)

Peak Temperature :	265°C
Dipping Time :	10 seconds
Soldering :	1 time

Physical Specifications

Weight	0.015oz., 0.4g
Case	JEDEC DO-204AC (DO-15) molded plastic body over passivated junction.
Polarity	Color band denotes the cathode except Bipolar.
Terminal	Matte Tin axial leads, solderable per JESD22-B102.

Environmental Specifications

High Temp. Storage	JESD22-A103
HTRB	JESD22-A108
Temperature Cycling	JESD22-A104
H3TRB	JESD22-A101
RSH	JESD22-B106

Dimensions

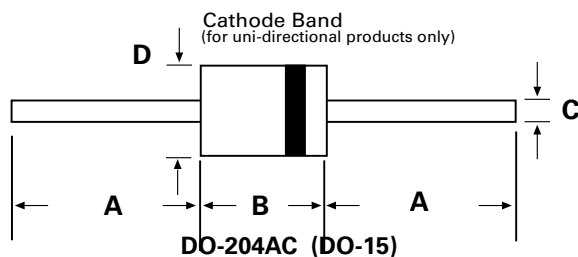

Dimensions	Inches		Millimeters	
	Min	Max	Min	Max
A	1.000	-	25.40	-
B	0.230	0.300	5.80	7.60
C	0.028	0.034	0.71	0.86
D	0.104	0.140	2.60	3.60

SAC Series

Axial Leaded – 500W

Part Numbering System

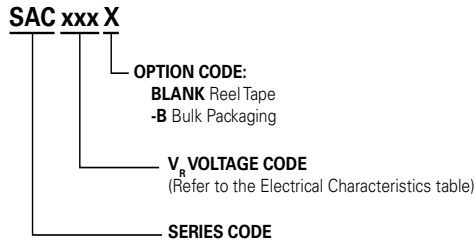

Part Marking System

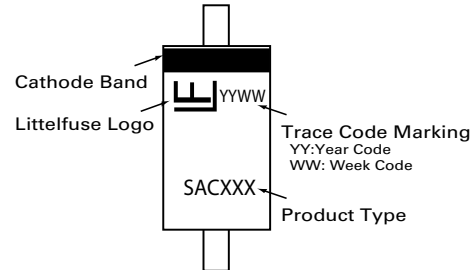

Packaging

Part Number	Component Package	Quantity	Packaging Option	Packaging Specification
SACxxxXX	DO-204AC	4000	Tape & Reel	EIA STD RS-296
SACxxxXX-B	DO-204AC	1000	BULK	Littelfuse Spec.

Tape and Reel Specification

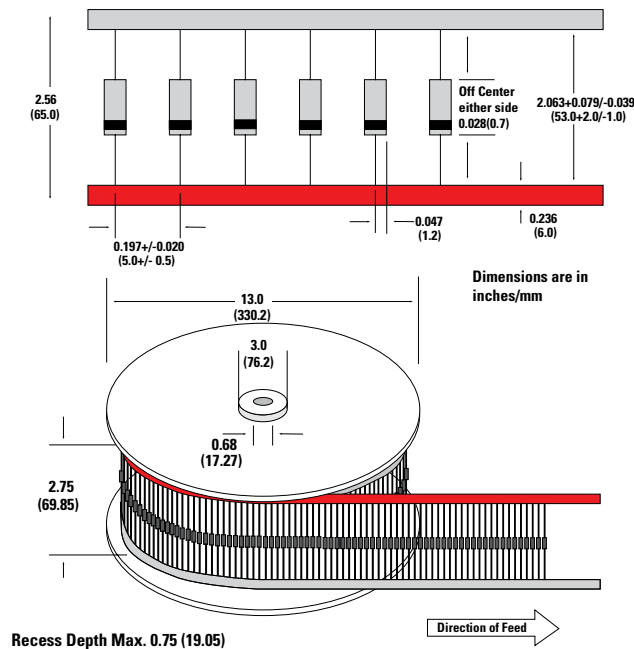

Disclaimer Notice - Information furnished is believed to be accurate and reliable. However, users should independently evaluate the suitability of and test each product selected for their own applications. Littelfuse products are not designed for, and may not be used in, all applications. Read complete Disclaimer Notice at www.littelfuse.com/disclaimer-electronics.