

Typical unit

FEATURES

- Quick response to load change
- Ultra small surface mount package
11.9x15.0x2.4mm
- High efficiency of 88%
- Outstanding thermal derating performance
- Over current protection
- On/Off control (Positive logic)
- I2C communication function
- Power Good signal
- High Reliability

PRODUCT OVERVIEW

The **MYMGC3R32EFPF2RB Series** is miniature MonoBK™, called “MonoBlock”, non-isolated Point-of-Load (POL) DC-DC power converters for embedded applications. The small form factor measures only 11.9x15.0x2.4mm. Applications include powering FPGA/CPU's, datacom/telecom systems, Distributed Bus Architectures (DBA), programmable logic and mixed voltage systems.

The converters have input voltage ranges of 4.3 to 5.5Vdc and a multiple output voltage. Based on a fixed frequency synchronous buck converter switching topology, this high power conversion efficient PoL module features On/Off control and Power Good signal output.

These converters also include under voltage lock out (UVLO), output short circuit protection and over-current protection.

SIMPLIFIED APPLICATION

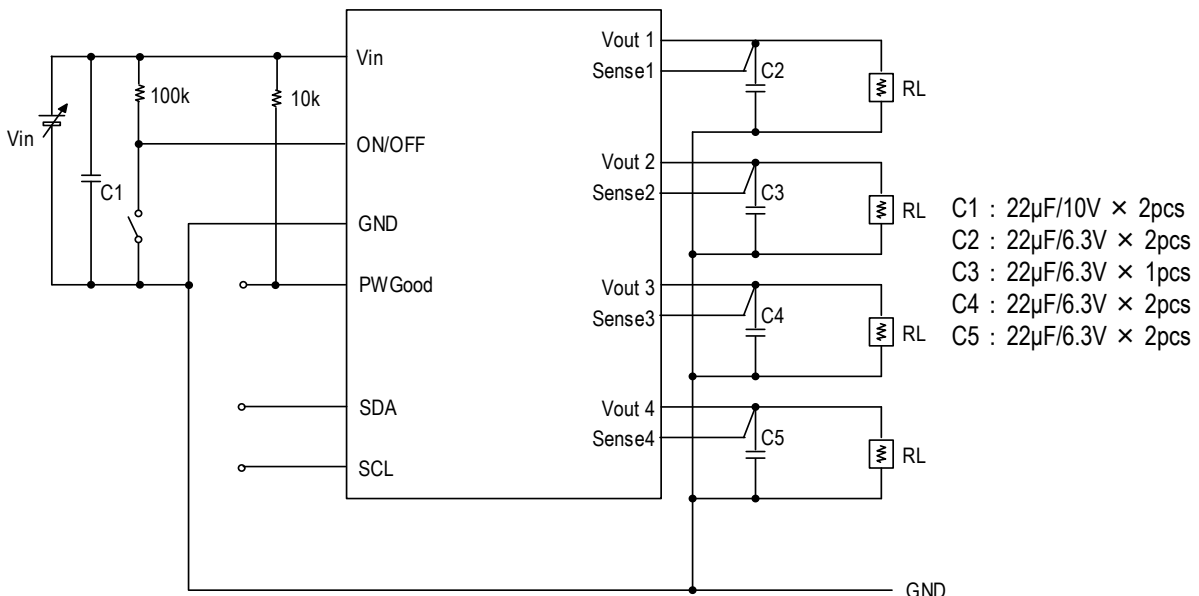

(Typical topology is shown. Murata recommends an external input fuse.)

PERFORMANCE SPECIFICATIONS SUMMARY AND ORDERING GUIDE (Including series products)

PART NUMBER	OUTPUT						INPUT				Efficiency (%)	ON/OFF	Package (mm)
	Vout (Vdc)	Iout (A,max.)	Power (W)	R/N typ. (% of Vout)	Regulation(max.) Line(%) Load(%)		Vin typ. (Vdc)	Range (Vdc)	Iin no load (mA)	Iin full load (A)			
MYMGC3R32EFPF2RB	1.2	2.5	3.00	1	±0.5	±1.0	5	4.3 – 5.5	85	3.45	88	Yes (Positive)	12.0 x 15.0 x 2.4
	1.8	1.0	1.80	1	±0.5	±1.0							
	3.3	2.0	6.60	1	±0.5	±1.0							
	2.5	1.5	3.75	1	±0.5	±1.0							
MYMGC3R32EFPF2RBD	1.2	2.5	3.00	1	±0.5	±1.0	5	4.3 – 5.5	85	3.45	88	Yes (Positive)	12.0 x 15.0 x 2.4
	1.8	1.0	1.80	1	±0.5	±1.0							
	3.3	2.0	6.60	1	±0.5	±1.0							
	2.5	1.5	3.75	1	±0.5	±1.0							

- Please refer to the Part Number Structure for additional ordering information and options.
- All specifications are at nominal line voltage, Vout=nominal and full load, +25degC unless otherwise noted. Output capacitors are 22uF*2, for Vout2 are 22uF*1, ceramic. Input cap is 22 uF*2 ceramic and plenty electrolytic capacitors. See detailed specifications. I/O caps are necessary for our test equipment.
- Use adequate ground plane and copper thickness adjacent to the converter.

PART NUMBER STRUCTURE

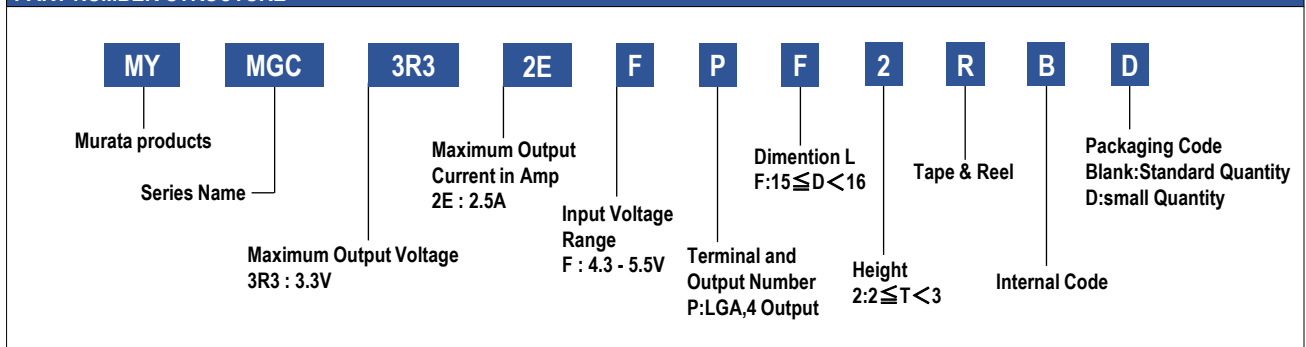

Product Marking



Because of the small size of these products, the product marking contains a character-reduced code to indicate the model number and manufacturing date code. Not all items on the marking are always used. Please note that the marking differs from the product photograph. Here is the layout of the Marking.

Part Number	Product Code
MYMGC3R32EFPF2RB	MGC3R32EFPF2RB
MYMGC3R32EFPF2RBD	MGC3R32EFPF2RB

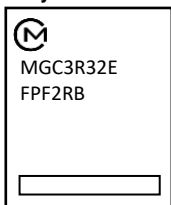
Layout



Codes (reference)

-  1Pin Marking
-  MGC3R32EFPF2RB Product code (Please see product code table beside)
-  Internal Manufacturing code

FUNCTIONAL SPECIFICATIONS OF MYMGC3R32EFPF2RB (Note 1)

ABSOLUTE MAXIMUM RATINGS	Conditions	Minimum	Typical	Maximum	Units
Input Voltage		-0.3		6.0	Vdc
ON/OFF Pin	Power on, referred to -Vin	-0.3		Vin+0.3	Vdc
PGOOD/Trim Pins	Power on, referred to -Vin		Source ONLY		
Output Current Vout1 See Note2				2.5	A
Output Current Vout2 See Note2				1.0	A
Output Current Vout3 See Note2				2.0	A
Output Current Vout4 See Note2				1.5	A
Storage Temperature Range	Vin = Zero (no power)	-40		85	degC

Absolute maximums are stress ratings. Exposure of devices to greater than any of these conditions may adversely affect long-term reliability. Proper operation under conditions other than those listed in the Performance/Functional Specifications Table is not implied or recommended.

INPUT	Conditions	Minimum	Typical	Maximum	Units
Operating Voltage Range		4.3	5	5.5	Vdc
Start-up Threshold	Rising input voltage		2.55		Vdc
Under Voltage Shutdown	Note 12		2.25		Vdc
Internal Filter Type			Capacitive		
Input Current					
Ful Load Conditions	Vin = nominal		3.45		A
Low Line	Vin = minimum		3.96		A
No Load Current	Iout = minimum, unit = ON		85		mA

GENERAL and SAFETY	Conditions	Minimum	Typical	Maximum	Units
Efficiency	Vin = 5.0V, Io = Max.		88		%
Calculated MTBF (Note 3)	Ta=40degC, Vin = nom, Vout = nom, Iout = 50%		1,147,483		hours

DYNAMIC CHARACTERISTICS	Conditions	Minimum	Typical	Maximum	Units
Fixed Switching Frequency			1650		kHz
Startup Time (Vin ON)	Vout = nominal (Vin = On to 90% of Vo)		See the graph		ms
Startup Time (Remote ON)	Vout = nominal (Remote = On to 90% of Vo)		See the graph		ms
Dynamic Load Peak Deviation	50-100% load step, di/dt		2.5		A/μsec
Dynamic Load Peak Deviation	Same as above		±3%		Voset

FUNCTIONS	Conditions	Minimum	Typical	Maximum	Units
Remote On/Off Control (Note 4)					
Logic					
ON State Range		1.3		Vin-0.3	V
OFF Stage Range		-0.3		0.4	V
Control Current	Open collector/drain			-	mA
Power-Good Output (Pulled up to 5.0Vreg(typ.) internally)					
Power-Good Rising Threshold	No protect		90%		Voset
Power-Good Falling Threshold	No protect		80%		Voset

FUNCTIONAL SPECIFICATIONS OF MYMGC3R32EFPF2RB (Note 1)

OUTPUT	Conditions	Minimum	Typical	Maximum	Units
Total Output Power	See Derating	0		15.15	W
Voltage					
Output Voltage Vout1	Note 9		1.2		Vdc
Output Voltage Vout2	Note 9		1.8		Vdc
Output Voltage Vout3	Note 9		3.3		Vdc
Output Voltage Vout4	Note 9		2.5		Vdc
Minimum Loading			Note		
Accuracy (50% load)	Vin = 5.0V, Ta = 25degC	-2.0		2.0	% of Vout
Overvoltage Protection			-		Vdc
Undervoltage Protection			-		Vdc
Current					
Output Current Range Vout1	Note 2	0		2.5	A
Current Limit Inception Vout1	After warmup		5.8		A
Output Current Range Vout2		0		1	A
Current Limit Inception Vout2			3.9		A
Output Current Range Vout3		0		2	A
Current Limit Inception Vout3			4.5		A
Output Current Range Vout4		0		1.5	A
Current Limit Inception Vout4			3.5		A
Short Circuit					
Short Circuit Duration (remove short for recovery)	Output shorted to ground, no damage		Continuous		
Short Circuit Protection Method	Note 5		Hiccup		
Pre-bias Start-up		Converter will start up if the external output voltage is less than set Vout.			
Regulation (Note 8)					
Line Regulation	Vin = min. to max.		±0.5		% of Vout
Load Regulation	Iout = min. to max.		±1.0		% of Vout
Temperature variation	Ta = -40 to 85degC		±0.5		% of Vout
Total output voltage variation	Fixed Input Voltage			±3.0	% of Vout
Ripple and Noise (20MHz bandwidth)	Note 6		10	20	mV pk-pk
External Output Capacitance Range (Note 11) Vout1, Vout3, Vout4		44		300	uF
External Output Capacitance Range (Note11) Vout2		22		300	uF
MECHANICAL(Common)					
Conditions					
Mechanical Dimension	L x W x H	11.9(typ.) x 15.0(typ.) x 2.4(max.)			mm
Weight			1.2		grams
ENVIRONMENTAL(Common)					
Conditions					
Operating Ambient Temperature Range	With Derating (Note 2, 7)	-40		85	degC
Storage Temperature Range	Vin = Zero (no power)	-40		85	degC
Thermal Protection/Shutdown	Measured in module (Note 10)		150		degC
Thermal Protection/Shutdown (Recovery)	Measured in module (Note 10)		130		degC
Moisture Sensitivity Level			3		

Specification Notes

- (1) Specifications are typical at +25degC, Vin=nominal +5.0V, Vout=nominal (+1.2V, +1.8V, +3.3V, +2.5V), full load, external caps and natural convection unless otherwise indicated. Extended tests at full power must supply substantial natural airflow. All models are tested and specified with external 22uF*1 or 2 ceramic output capacitors and a 22 uF*2 ceramic and plenty electrolytic external input capacitors. All capacitors are low ESR types. These capacitors are necessary to accommodate our test equipment and may not be required to achieve specified performance in your applications. However, Murata recommends installation of these capacitors. All models are stable and regulate within spec under no-load conditions.
- (2) Note that Maximum Power Derating curves indicate an average current at nominal input voltage. At higher temperatures and/or lower airflow, the DC/DC converter will tolerate brief full current outputs if the total RMS current over time does not exceed the Derating curve.
- (3) Mean Time Between Failure is calculated using the MIL-HDBK-217, Tpcboard = +40degC, half output load, natural air convection.
- (4) The On/Off Control Input should use either a switch or an open collector/open drain transistor referenced to Input Common. A logic gate may also be used by applying appropriate external voltages which do not exceed +Vin
- (5) The overcurrent operation stops the output of the converter when it detects an overcurrent condition. After the failure has been removed, the converter will restore normal operation by restart.

- (6) Output noise may be further reduced by adding an external filter. At zero output current, the output may contain low frequency components which exceed the ripple specification. The output may be operated indefinitely with no load.
- (7) All models are fully operational and meet published specifications, including "cold start" at -40degC.
- (8) Regulation specifications describe the deviation as the line input voltage or output load current is varied from a nominal midpoint value to either extreme.
- (9) Other input or output voltage ranges will be reviewed under scheduled quantity special order.
- (10) Thermal Protection/Shutdown temperature is measured with the sensor in the converter.
- (11) The maximum output capacitive loads depend on the Equivalent Series Resistance (ESR) of the external output capacitor and, to a lesser extent, the distance and series impedance to the load. Larger caps will reduce output noise but may change the transient response. Newer ceramic caps with very low ESR may require lower capacitor values to avoid instability. Thoroughly test your capacitors in the application. Please refer to the Output Capacitive Load Application Note.
- (12) Do not allow the input voltage to degrade lower than the input under voltage shutdown voltage at all times. Otherwise, you risk having the converter turn off. The under voltage shutdown is not latching and will attempt to recover when the input is brought back into normal operating range.
- (13) The outputs are not intended to sink appreciable reverse current.

Internal Circuit Diagrams

ON/OFF using guide

By using ON/OFF function, the operation of this product can be disabled without disconnection of input Voltage. Sequence of a power supply system and power-saving control can be easily achieved using this function.

ON/OFF control uage

- ON/OFF pin(9pin) are pull-up : Output Voltage = ON
- ON/OFF pin(9pin) are connected to GND : Output Voltage = OFF

Example

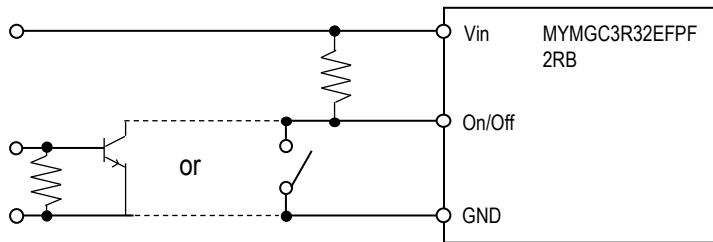

It is strongly recommended that on/off terminal should be used when you turn on/off this product. Characteristics may be affected by turning input voltage on/off. Please check product operation on your application with turning input voltage on/off.

ON/OFF Sequence

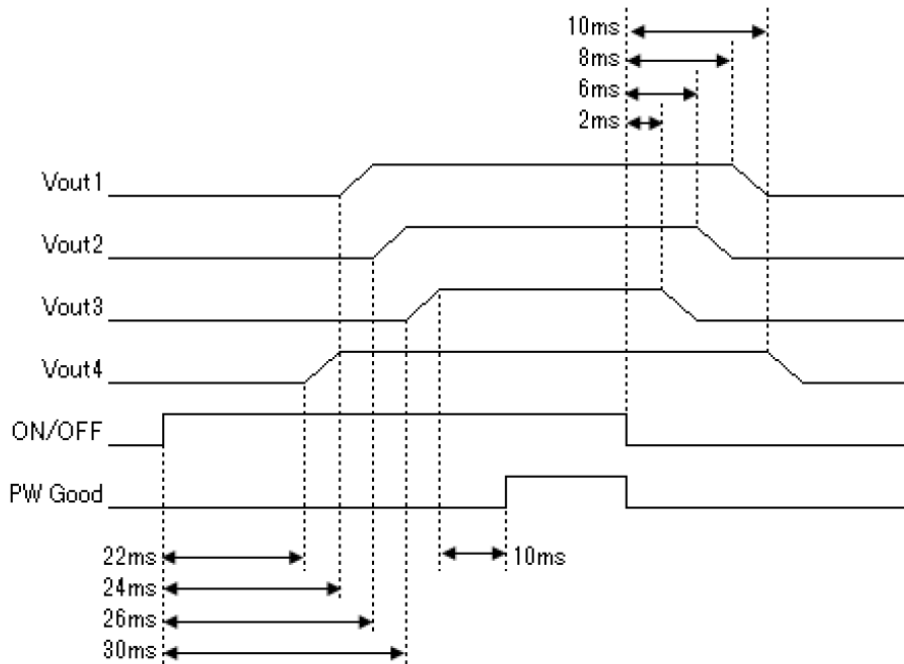

PowerGood(P.G) using guide

PW Good terminal is pulled up to Vin terminal. The value of resistance of pull up is 10kΩ. When this product is in following situation, the No.48 pin is on open-drain.

- Input voltage is 3.3V to 5.0V and ON/OFF pin is High.
- Output voltage is within voltage detection threshold (over 90% to under 110%)

When this product is in following situation, the No.48 pin is connected to GND.

- ON/OFF pin is Low
- Output Voltage is out of voltage detection threshold(Under 90% to over 110%)
- Between 10ms after output voltage4 is voltage detection threshold
- An under voltage condition exists for the DC-DC converter: PG is connected to GND.
- An overcurrent condition has been detected
- Die temperature is over 150degC.

PERFORMANCE DATA AND OSCILLOGRAMS OF MYMGC3R32EFPF2RB

Efficiency vs. Line Voltage and Load Current @ +25degC.

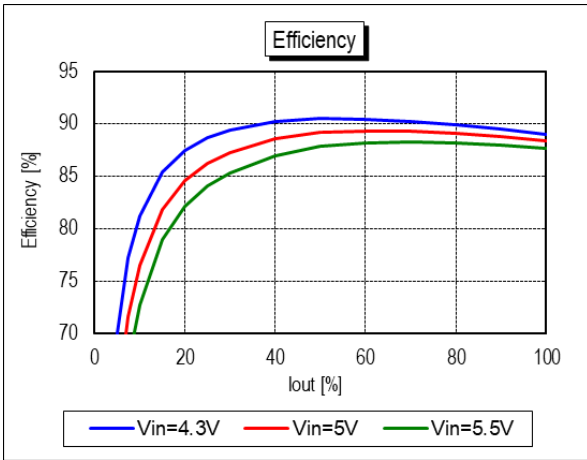

On/Off Enable Delay (Vin=5.0V, Iout=Max)
Trace1=Enable, Trace2=Vout1, Trace3=Vout2, Trace4=PW Good 10ms/div

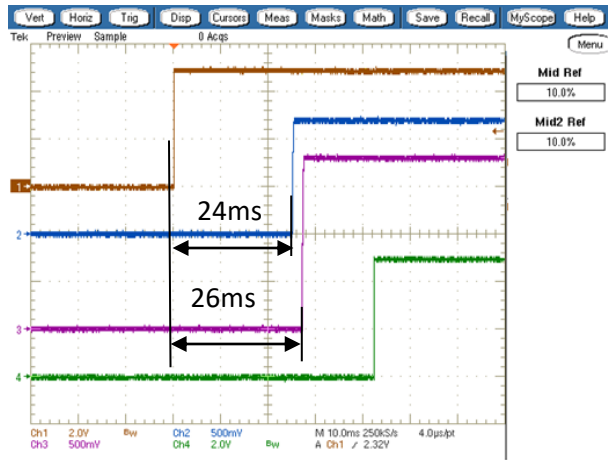

On/Off Enable Delay (Vin=5.0V, Iout=Max)
Trace1=Enable, Trace2=Vout3, Trace3=Vout4, Trace4=PW Good 10ms/div

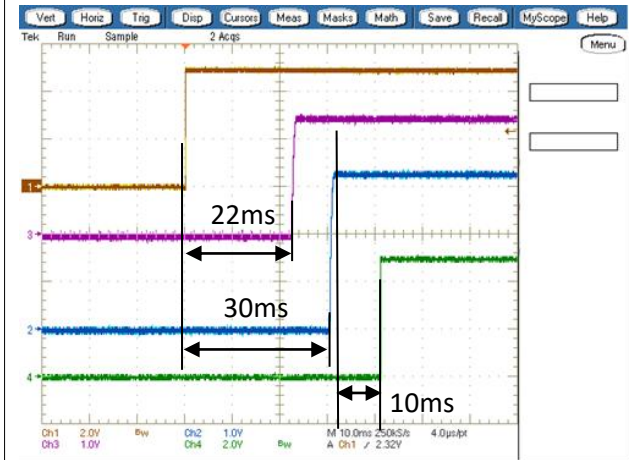

On/Off Enable Delay (Vin=5.0V, Iout=max)
Trace1=Enable, Trace2=Vout1, Trace3=Vout2, Trace4=PW Good 2ms/div

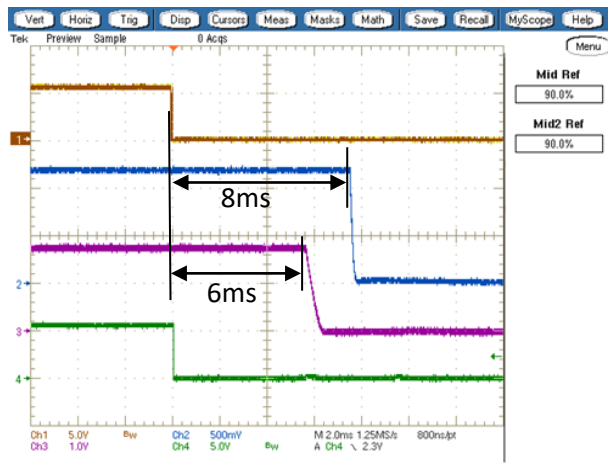

On/Off Enable Delay (Vin=5.0V, Iout=max)
Trace1=Enable, Trace2=Vout3, Trace3=Vout4, Trace4=PW Good 4ms/div

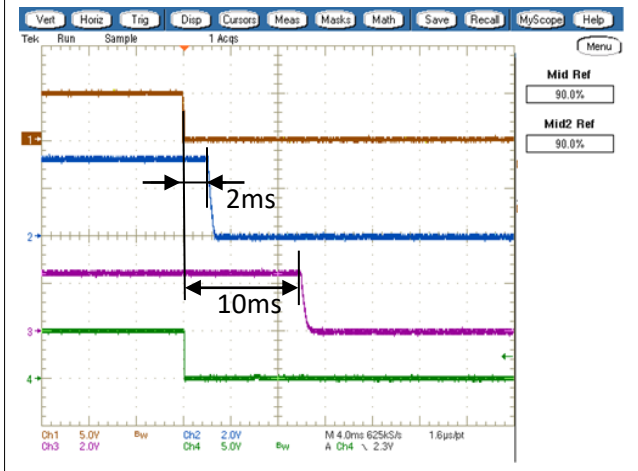

PERFORMANCE DATA AND OSCILLOGRAMS OF MYMGC3R32EFPF2RB

Vout1 vs. Line Voltage and Load Current @ +25degC.

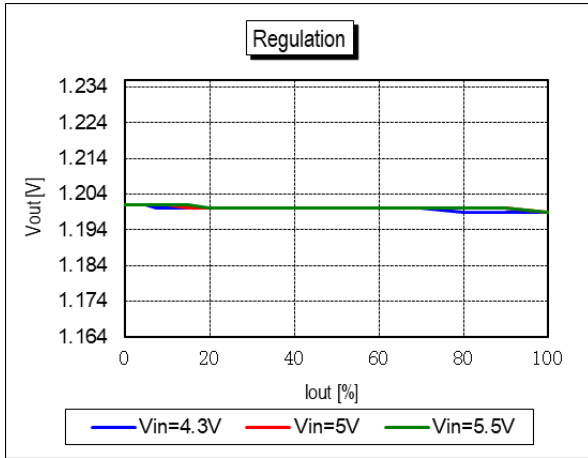

Vout2 vs. Line Voltage and Load Current @ +25degC.

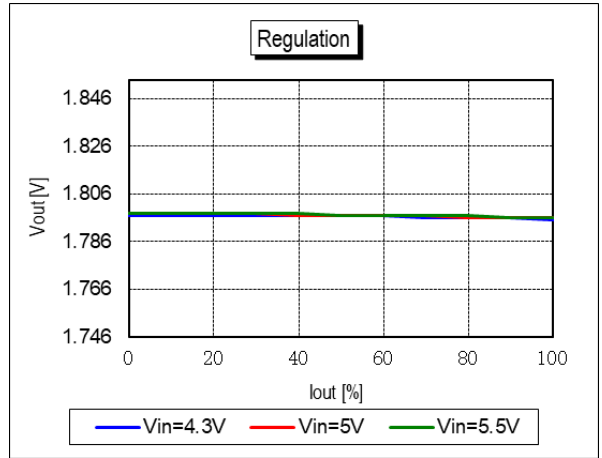

Vout3 vs. Line Voltage and Load Current @ +25degC.

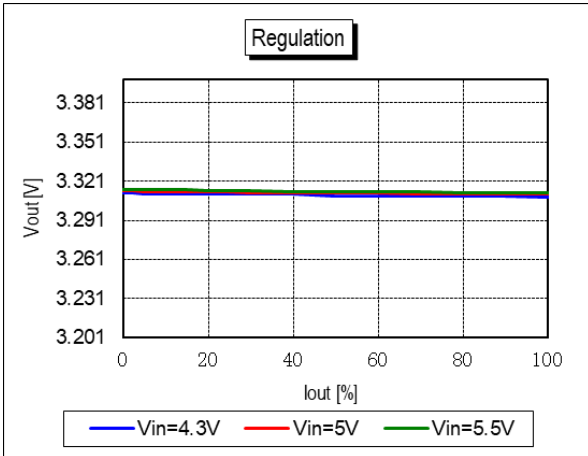

Vout4 vs. Line Voltage and Load Current @ +25degC.

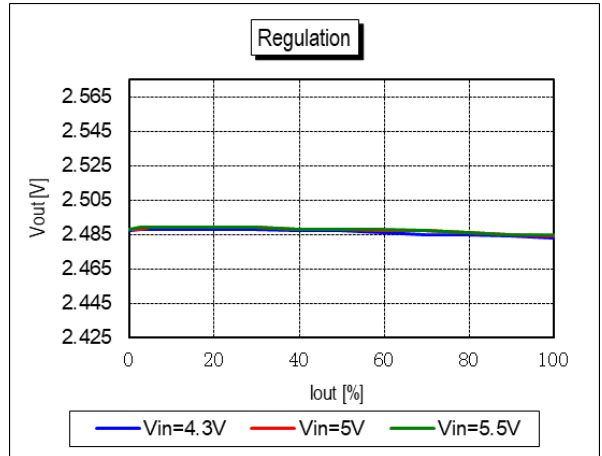

Step Load Transient Response (Vin=5V, Vout1=1.2V, Iout=1.25A to 2.5A) Trace 1=Vout1, 20 mV/div, Trace 4=Iout1, 2.0A/div.

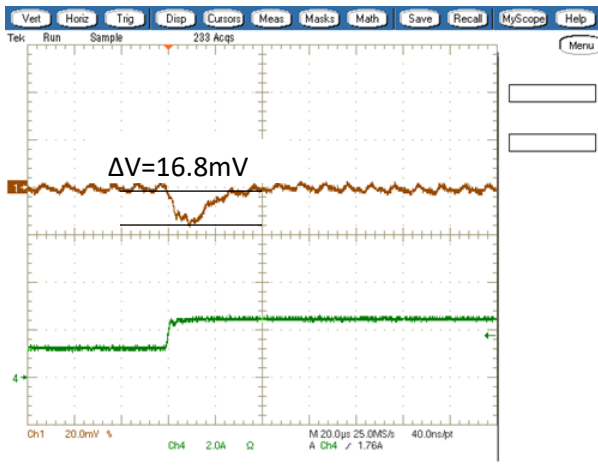

Step Load Transient Response (Vin=5V, Vout1=1.2V, Iout=2.5A to 1.25A) Trace 1=Vout1, 20 mV/div, Trace 4=Iout1, 2.0A/div.

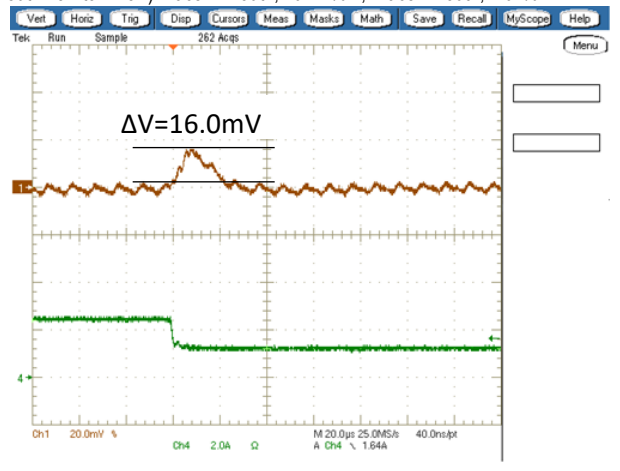

PERFORMANCE DATA AND OSCILLOGRAMS OF MYMGC3R32EFPF2RB

Step Load Transient Response (Vin=5V, Vout2=1.8V, Iout=0.5A to 1.0A) Trace 1=Vout2, 20 mV/div, Trace 4=Iout2, 1.0A/div.

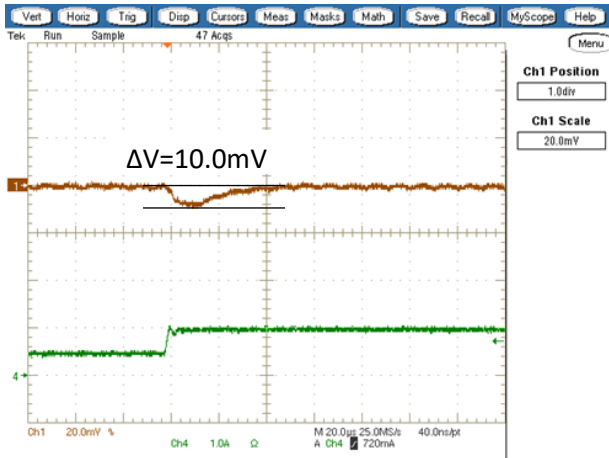

Step Load Transient Response (Vin=5V, Vout2=1.8V, Iout=1.0A to 0.5A) Trace 1=Vout2, 20 mV/div, Trace 4=Iout2, 1.0A/div.

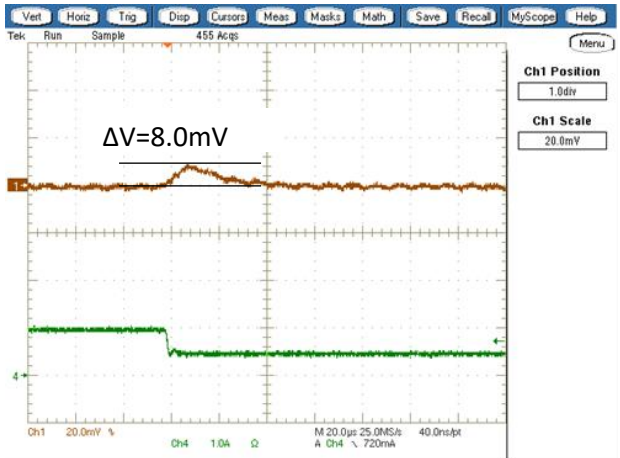

Step Load Transient Response (Vin=5V, Vout3=3.3V, Iout=1.0A to 2.0A) Trace 1=Vout3, 20 mV/div, Trace 4=Iout3, 2.0A/div.

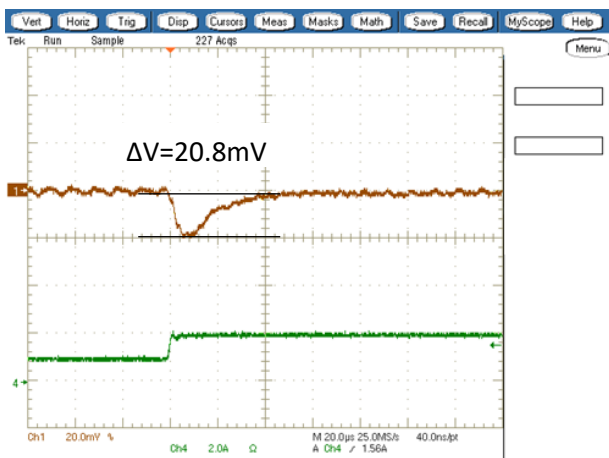

Step Load Transient Response (Vin=5V, Vout3=3.3V, Iout=2.0A to 1.0A) Trace 1=Vout3, 20 mV/div, Trace 4=Iout3, 2.0A/div.

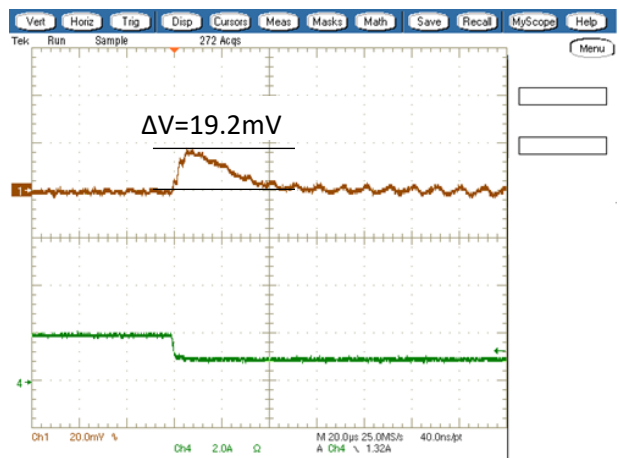

Step Load Transient Response (Vin=5V, Vout4=2.5V, Iout=0.75A to 1.5A) Trace 1=Vout4, 20 mV/div, Trace 4=Iout4, 1.0A/div.

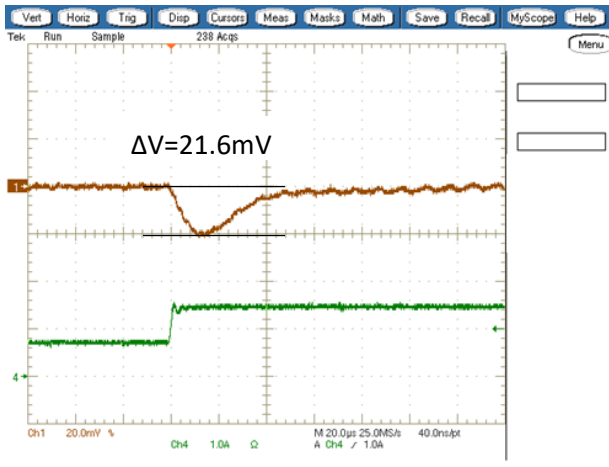

Step Load Transient Response (Vin=5V, Vout4=2.5V, Iout=1.5A to 0.75A) Trace 1=Vout4, 20 mV/div, Trace 4=Iout4, 1.0A/div.

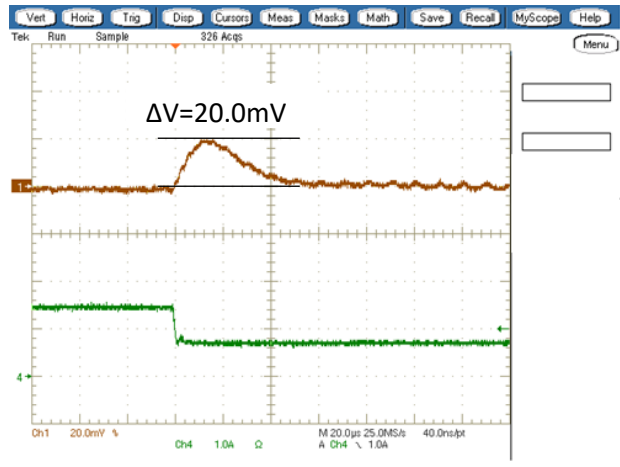

THERMAL DERATINGS OF MYMGC3R32EFPF2RB

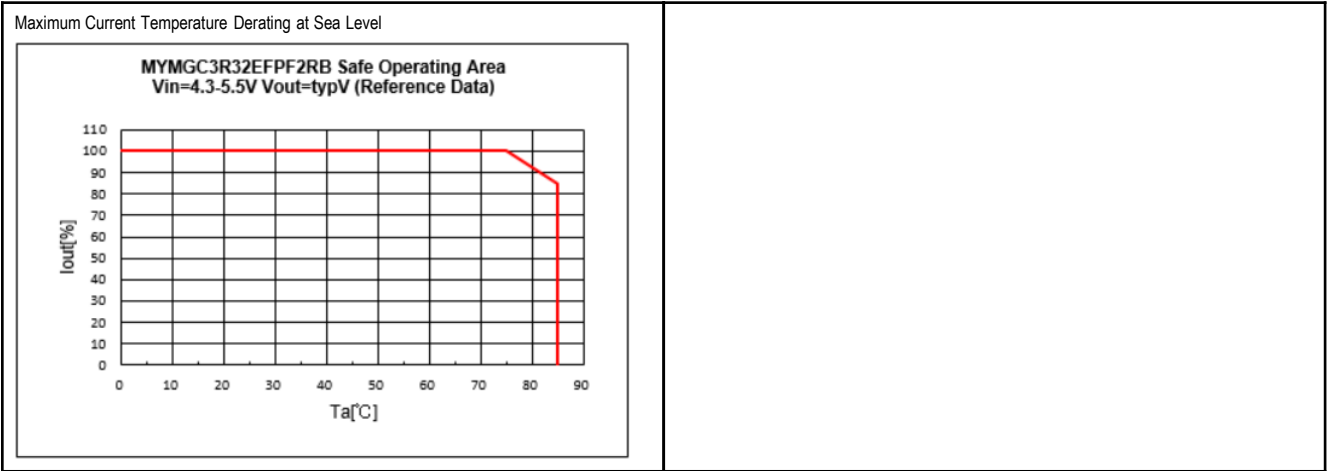

Thermal deratings are evaluated in following condition.

- The above de-rating limits apply to this product soldered directly to 101.6*50.0*1.6mm PCB (4reyer, with 35um copper) in the natural air-cooling condition. Any adjacent parts of high temperature may cause overheating. For reliable operation, please ensure that the Top side temperature of this product (Tc) is maintained below 100degC.
- No forced air flow.

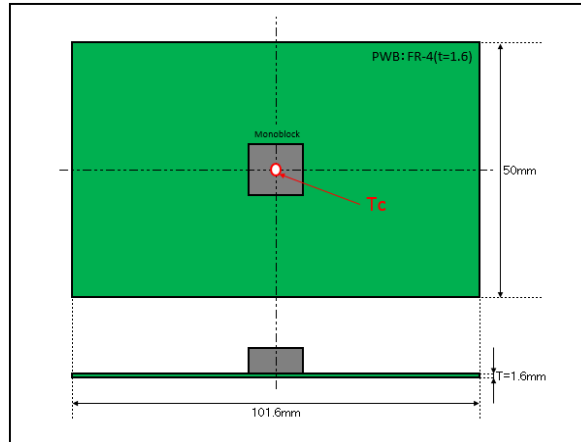

TRANSIENT RESPONSE DATAS OF MYMGC3R32EFPFB

Transient response data at various conditions are showed in following table.

Minimum output capacitance can serve less than 3% * Vo(nom) of deviation for 50% load change.

Vout(V)	Vin(V)	Cout(uF)	Voltage Deviation(mV)
			50-100% Load Step
1.2	4.3	22*2	21.6
	5.5		20.8
1.8	4.3	22*1	13.6
	5.5		12.8
3.3	4.3	22*2	32.8
	5.5		37.6
2.5	4.3	22*2	32.8
	5.5		32.0

*Cout is minimum output capacitance for the products.

MECHANICAL SPECIFICATIONS

Dimension and Pin Assignment

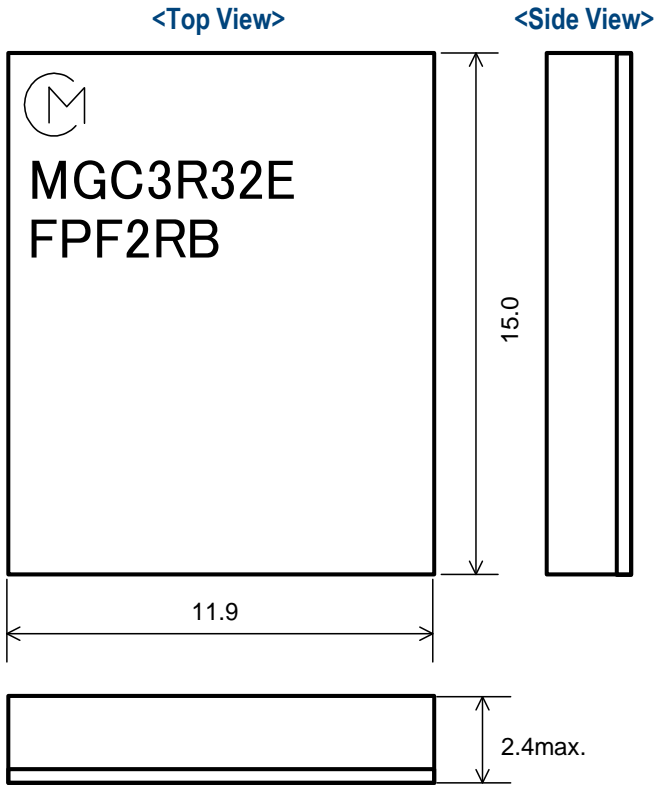

INPUT/OUTPUT CONNECTIONS		
Pin No.	Signal	Function
1-6	Vout2	Output Voltage2
7-12,20 26,34-39	GND	GND
13-18	Vout1	Output Voltage1
19	Sense2	Output Voltage2 Sense
21-25	Vin	Input
27	Sense4	Output Voltage4 Sense
28-33	Vout4	Output Voltage4
40-45	Vout3	Output Voltage3
46	Sense3	Output Voltage3 Sense
47	N.C.	No Connect
48	PW GOOD	Power Good
49	SCL	I2C interface
50	SDA	I2C interface
51	ON/OFF	Remote ON/OFF
52	Sense1	Output Voltage1 Sense
53-61	GND	Thermal PAD

Tolerance : ± 0.15
Coplanarity : less than 0.12
[Unit : mm]

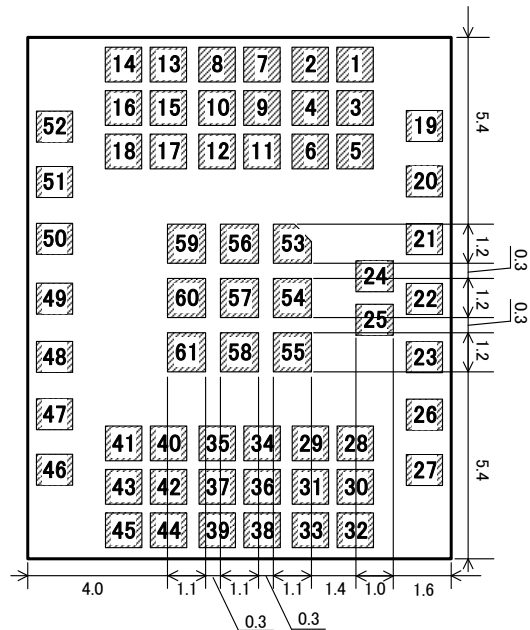
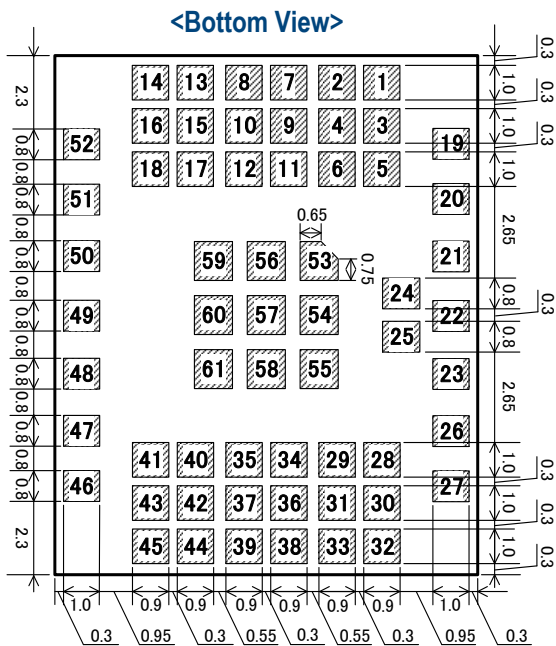

Recommended Board Land Pattern (Top View)

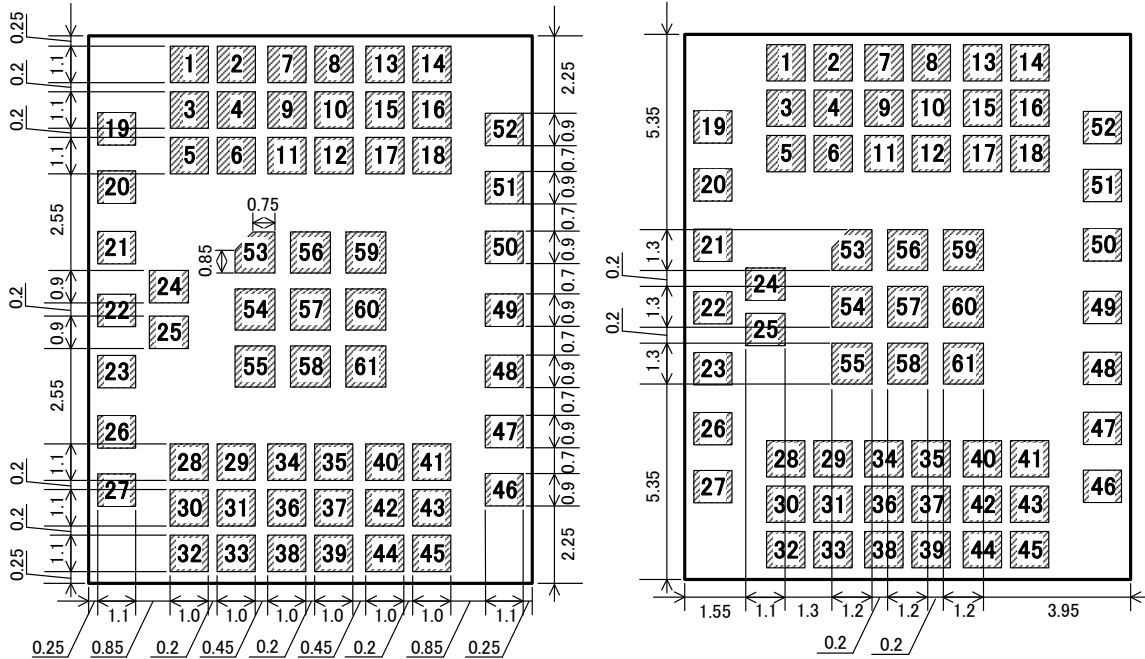

Unit: mm

Example of Pattern Layout (Top View)

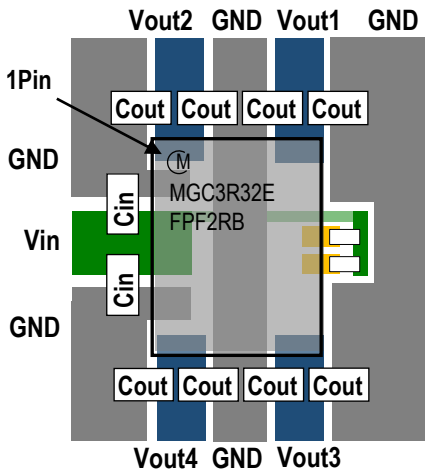

Picture

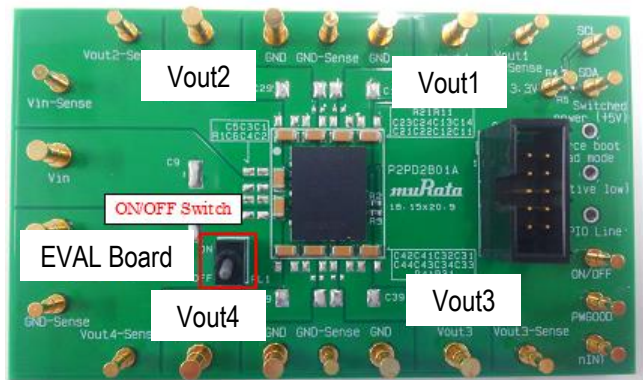

TAPE AND REEL INFORMATION

Tape Dimension

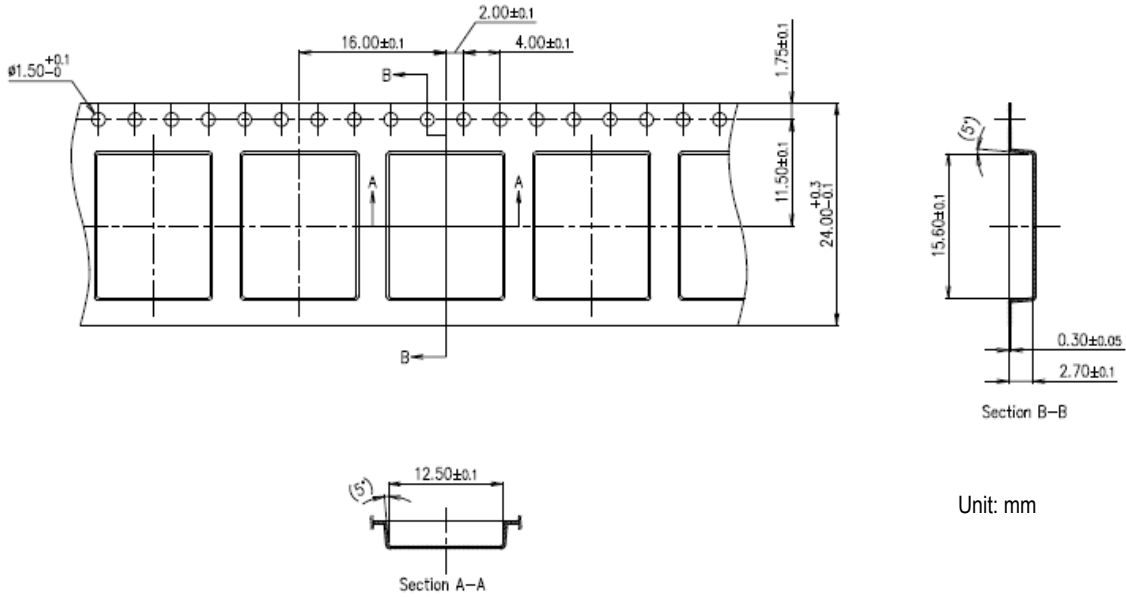

Unit: mm

Reel Dimension

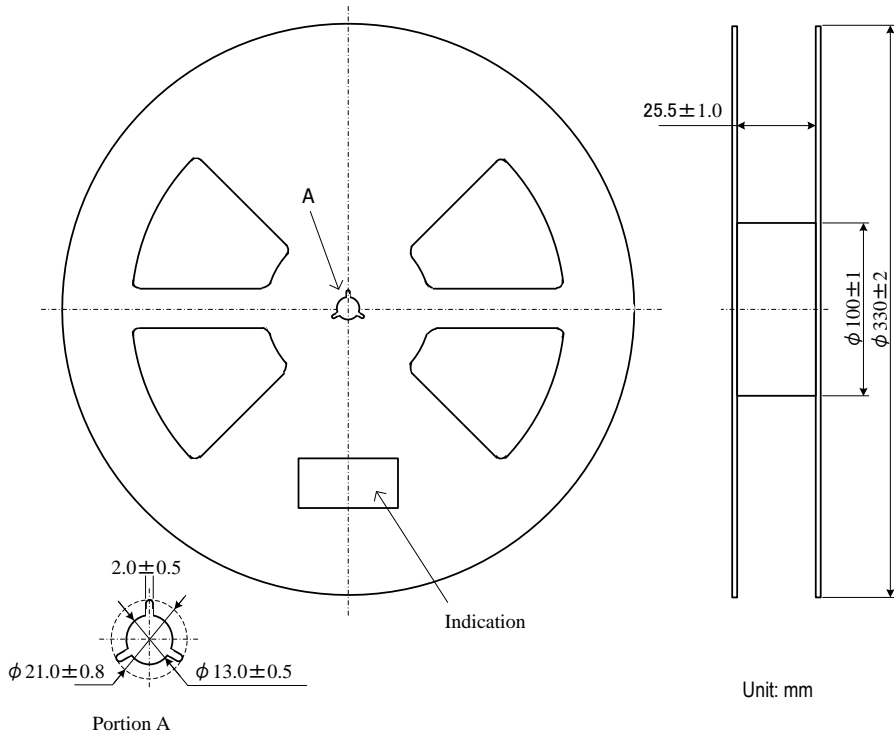

Unit: mm

TAPE SPECIFICATIONS

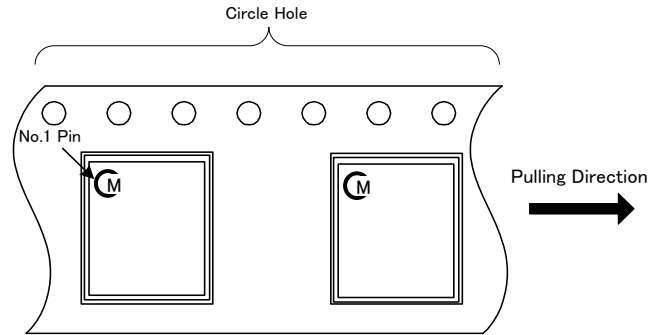
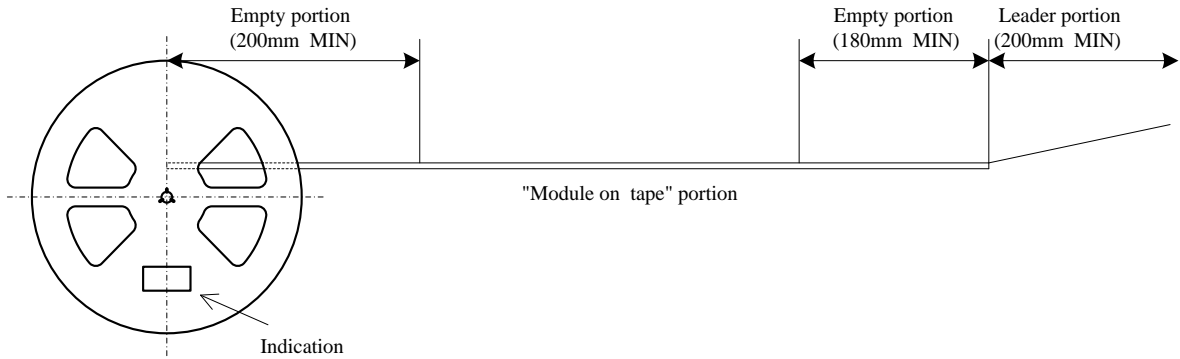

Note

1. The adhesive strength of the protective tape must be within 0.1-1.3N.
2. Each reel contains the quantities such as the table below.
3. Each reel set in moisture-proof packaging because of MSL 3.
4. No vacant pocket in "Module on tape" section.
5. The reel is labeled with Murata part number and quantity.
6. The color of reel is not specified.

Part Number	Qty(pcs)
MYMGC3R32EFPF2RB	400
MYMGC3R32EFPF2RBD	100

TECHNICAL NOTES

Input Fuse

Certain applications and/or safety agencies may require fuses at the inputs of power conversion components. Fuses should also be used when there is the possibility of sustained input voltage reversal which is not current limited. For greatest safety, we recommend a fast blow fuse installed in the ungrounded input supply line. The installer must observe all relevant safety standards and regulations. For safety agency approvals, install the converter in compliance with the end-user safety standard.

Input Under-Voltage Shutdown and Start-Up Threshold

Under normal start-up conditions, converters will not begin to regulate properly until the ramping-up input voltage exceeds and remains at the Start-Up Threshold Voltage (see Specifications). Once operating, converters will not turn off until the input voltage drops below the Under-Voltage Shutdown Limit. Subsequent restart will not occur until the input voltage rises again above the Start-Up Threshold. This built-in hysteresis prevents any unstable on/off operation at a single input voltage. Users should be aware however of input sources near the Under-Voltage Shutdown whose voltage decays as input current is consumed (such as capacitor inputs), the converter shuts off and then restarts as the external capacitor recharges. Such situations could oscillate. To prevent this, make sure the operating input voltage is well above the UV Shutdown voltage at all times.

Start-Up Time

Assuming that the output current is set at the rated maximum, the Vin to Vout Start-Up Time (see Specifications) is the time interval between the point when the ramping input voltage crosses the Start-Up Threshold and the fully loaded regulated output voltage enters and remains within its specified accuracy band. Actual measured times will vary with input source impedance, external input capacitance, input voltage slew rate and final value of the input voltage as it appears at the converter.

These converters include a soft start circuit to moderate the duty cycle of its PWM controller at power up, thereby limiting the input inrush current. The On/Off Remote Control interval from On command to Vout regulated assumes that the converter already has its input voltage stabilized above the Start-Up Threshold before the On command. The interval is measured from the On command until the output enters and remains within its specified accuracy band. The specification assumes that the output is fully loaded at maximum rated current. Similar conditions apply to the On to Vout regulated specification such as external load capacitance and soft start circuitry.

Recommended Input Filtering

The user must assure that the input source has low AC impedance to provide dynamic stability and that the input supply has little or no inductive content, including long distributed wiring to a remote power supply. For best performance, we recommend installing a low-ESR capacitor immediately adjacent to the converter's input terminals.

The capacitor should be a ceramic type such as the Murata GRM32 series and an electrolytic type such as Panasonic OS-CON series. Initial suggested capacitor values are 22 uF x 2 ceramic type, rated at twice the expected maximum input voltage. Make sure that the input terminals do not go below the under voltage shutdown voltage at all times. More input bulk capacitance may be added in parallel (either electrolytic or tantalum) if needed.

Recommended Output Filtering

The converter will achieve its rated output ripple and noise with additional external capacitor. The user may install more external output capacitance reduce the ripple even further or for improved dynamic response. Again, use low-ESR ceramic (Murata GRM32 series). Initial values of 22 uF x 1 or 2 ceramic type may be tried, either single or multiple capacitors in parallel. Mount these close to the converter. Measure the output ripple under your load conditions. Use only as much capacitance as required to achieve your ripple and noise objectives. Excessive capacitance can make step load recovery sluggish or possibly introduce instability. Do not exceed the maximum rated output capacitance listed in the specifications.

Output Noise

All models in this converter series are tested and specified for output noise using designated external output components, circuits and layout as shown in the figures below. In the figure below, the two copper strips simulate real-world printed circuit impedances between the power supply and its load. In order to minimize circuit errors and standardize tests between units, scope measurements should be made using BNC connectors or the probe ground should not exceed one half inch and soldered directly to the test circuit.

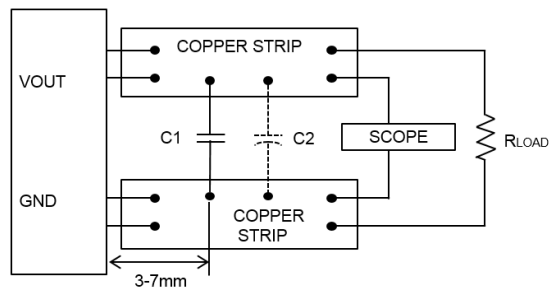

C1=22uF x 1 or 2 CERAMIC
C2=OPEN
Figure : Measuring Output Ripple and Noise

Minimum Output Loading Requirements

All models regulate within specification and are stable under no load to full load conditions. Operation under no load might however slightly increase output ripple and noise.

Thermal Shutdown

To prevent many over temperature problems and damage, these converters include thermal shutdown circuitry. If environmental conditions cause the temperature of the converter's to rise above the Operating Temperature Range up to the shutdown temperature, an on-board electronic temperature sensor will power down the unit. When the temperature decreases below the turn-on threshold, the converter will automatically restart.

CAUTION: If you operate too close to the thermal limits, the converter may shut down suddenly without warning. Be sure to thoroughly you're your application to avoid unplanned thermal shutdown.

Temperature Derating Curves

The graphs in this data sheet illustrate typical operation under a variety of conditions. The derating curves show the maximum continuous ambient air temperature. Note that these are AVERAGE measurements.

Note that the temperatures are of the ambient airflow, not the converter itself which is obviously running at higher temperature than the outside air. Also note that very low flow rates (below about 25 LFM) are similar to "natural convection," that is, not using fan-forced airflow. Murata makes Characterization measurements in a closed cycle wind tunnel with calibrated airflow. We use both thermocouples and an infrared camera system to observe thermal performance.

CAUTION: These graphs are all collected at slightly above Sea Level altitude. Be sure to reduce the derating for higher density altitude.

Output Current Limiting

Current limiting inception is defined as the point at which full power falls below the rated tolerance. See the Performance/Functional Specifications. Note particularly that the output current may briefly rise above its rated value in normal operation as long as the average output power is not exceeded. This enhances reliability and continued operation of your application. If the output current is too high, the converter will enter the short circuit condition.

Output Short Circuit Condition

When a converter is in current-limit mode, the output voltage will drop as the output current demand increases. Following a time-out period, the converter will restart, causing the output voltage to begin ramping up to its appropriate value. If the short-circuit condition persists, another shutdown cycle will initiate. This rapid on/off cycling is called "hiccup mode". The hiccup cycling reduces the average output current, thereby preventing excessive internal temperatures and/or component damage. A short circuit can be tolerated indefinitely.

The "hiccup" system differs from older latching short circuit systems because you do not have to power down the converter to make it restart. The system will automatically restore operation as soon as the short circuit condition is removed.

Output Voltage Remote Sense

This function is capable to compensate up the voltage drop between the output and input of load. The voltage of the Vout pin must NOT be over their allowed maximum voltage if using the remote sense. The sense trace should be connected to Vout line as shortly as possible. The sense trace should be shielded by GND line or something else to reduce noise pickup. The sense line length is recommended within 10cm for output voltage stability. If the remote sense is not needed, the Sense pin should be connected to the Vout pin directly.

Remote On/Off Control

Please refer to the Connection Diagram on page 1 for On/Off connections. Positive logic models are enabled when the On/Off pin is left open or is pulled high to Vin with respect to GND. An internal bias current causes the OVP open pin to rise to Vin. Positive-polarity devices are disabled when the On/Off is grounded or brought to within a low voltage (see Specifications) with respect to GND.

Dynamic control of the On/Off function should be able to sink appropriate signal current when brought low and withstand appropriate voltage when brought high. Be aware too that there is a finite time in milliseconds (see Specifications) between the time of On/Off Control activation and stable, regulated output. This time will vary slightly with output load type and current and input conditions.

Output Capacitive Load

Users should only consider adding capacitance to reduce switching noise and/or to handle spike current load steps. Install only enough capacitance to achieve noise objectives. Excess external capacitance may cause regulation problems, degraded transient response and possible oscillation or instability.

Soldering Guidelines

Murata recommends the specifications below when installing these converters. These specifications vary depending on the solder type. Exceeding these specifications may cause damage to the product. Your production environment may differ therefore please thoroughly review these guidelines with your process engineers.

This product can be reflowed once.

Soldering Guidelines

Murata recommends the specifications below when installing these converters. These specifications vary depending on the solder type. Exceeding these specifications may cause damage to the product. Your production environment may differ therefore please thoroughly review these guidelines with your process engineers. This product can be reflowed once.

Reflow Solder Operations for surface-mount products	
For Sn/Ag/Cu based solders:	
Preheat Temperature	Less than 1degC per second
Time over Liquidus	45 to 75 seconds
Maximum Peak Temperature	245degC
Cooling Rate	Less than 3degC per second
For Sn/Pb based solders:	
Preheat Temperature	Less than 1degC per second
Time over Liquidus	60 to 75 seconds
Maximum Peak Temperature	235degC
Cooling Rate	Less than 3degC per second

Pb-free solder processes

For Pb-free solder processes, the product is qualified for MSL 3 according to IPC/JEDEC standard J-STD-020D. During reflow PRODUCT must not exceed 250degC at any time.

Dry Pack Information

Products intended for Pb-free reflow soldering processes are delivered in standard moisture barrier bags according to IPC/JEDEC standard J-STD-033. (Handling, packing, shipping and use of moisture/reflow sensitivity surface mount devices.) Using products in high temperature Pb-free soldering processes requires dry pack storage and handling. In case the products have been stored in an uncontrolled environment and no longer can be considered dry, the modules must be baked according to J-STD-033.

Recommended Lead-free Solder Reflow Profile

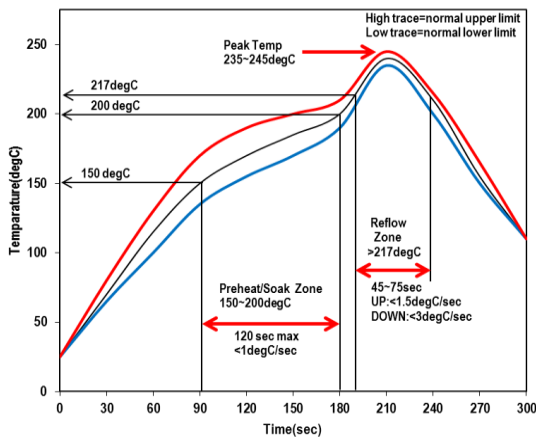

CAUTION: Do not reflow the converter as follows, because the converter may fall from the substrate during reflowing.

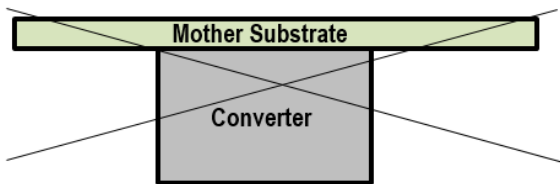

APPENDIX

Test Circuit

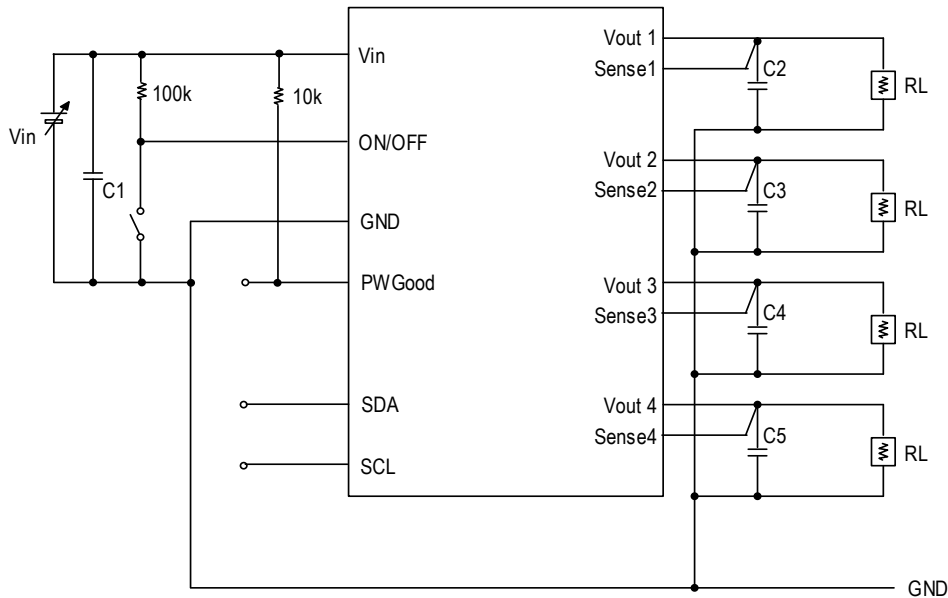

Vin : DC Power Supply

RL : Electronic Load Device

C1 : 22 μ F/10V \times 2pcs (GCM31CR71A226KE02 : Murata)

C2 : 22 μ F/6.3V \times 2pcs (GCM31CR70J226KE23 : Murata)

C3 : 22 μ F/6.3V \times 1pcs (GCM31CR70J226KE23 : Murata)

C4 : 22 μ F/6.3V \times 2pcs (GCM31CR70J226KE23 : Murata)

C5 : 22 μ F/6.3V \times 2pcs (GCM31CR70J226KE23 : Murata)

*It is strongly recommended that on/off terminal should be used when you turn on/off this product. Characteristics may be affected by turning input voltage on/off. Please check product operation on your application with turning input voltage on/off. It is recommended that the reset IC would be used acceptably to the input voltage specification, because this product have wide input voltage range.

If there is a long inductive cable length between the input power source and converter, then some additional bulk decoupling capacitance (eg. up to 1000uF) may be necessary to ensure a low AC impedance power source.



This product is subject to the following [operating requirements](#) and the [Life and Safety Critical Application Sales Policy](#):
Refer to: <https://power.murata.com/en/requirements>

Murata Manufacturing Co., Ltd makes no representation that the use of its products in the circuits described herein, or the use of other technical information contained herein, will not infringe upon existing or future patent rights. The descriptions contained herein do not imply the granting of licenses to make, use, or sell equipment constructed in accordance therewith. Spec and cautions are subject to change without notice. © 2018 Murata Manufacturing Co., Ltd