

CUTE-3-W

~40° wide beam with 1.5 mm high location pins

SPECIFICATION:

Dimensions	Ø 35.0 mm
Height	15 mm
Fastening	glue, pin
ROHS compliant	yes ⓘ



MATERIALS:

Component	Type	Material	Colour	Finish
CUTE-3-W	Multi-lens	PMMA	clear	



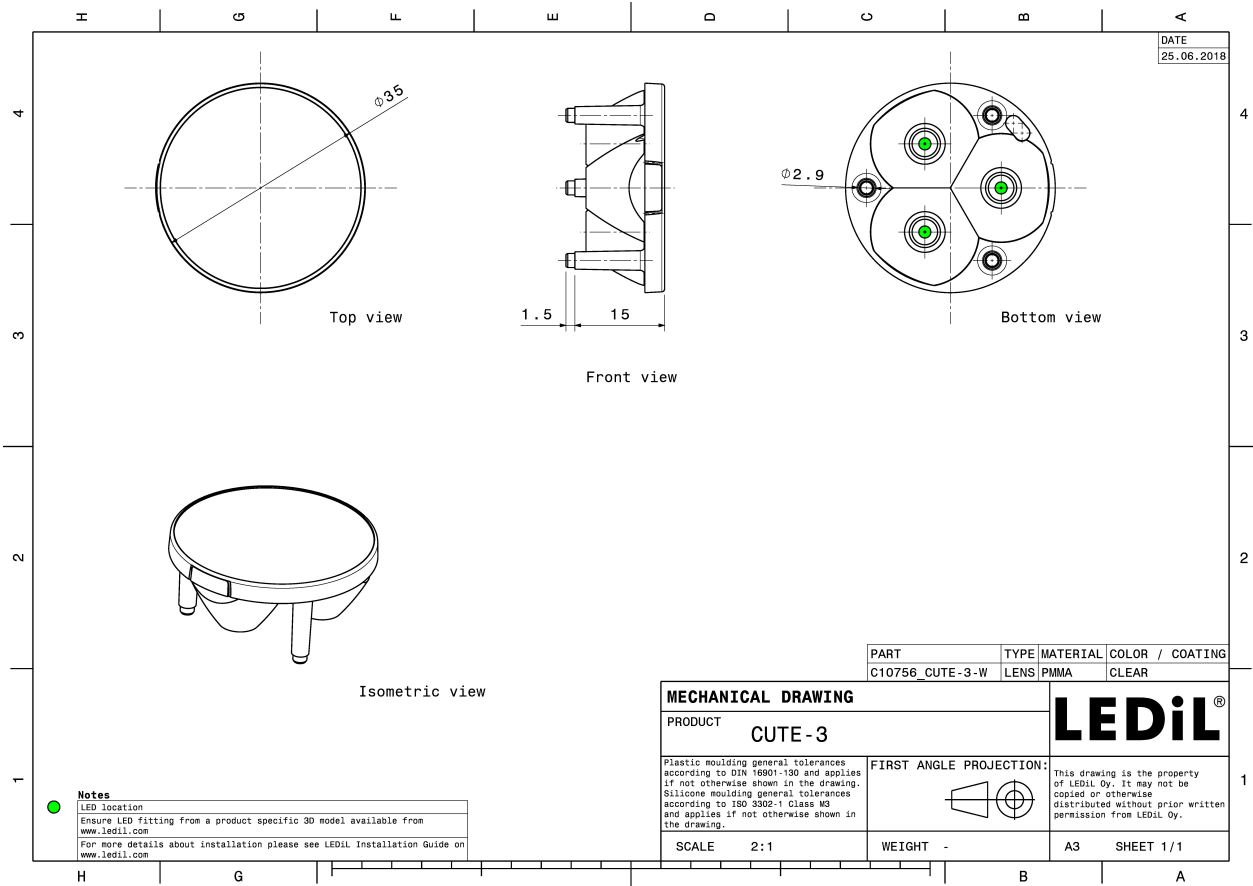

ORDERING INFORMATION:

Component	Qty in box	MOQ	MPQ	Box weight (kg)
C10756_CUTE-3-W » Box size: 480 x 280 x 300 mm	630	90	45	7.0

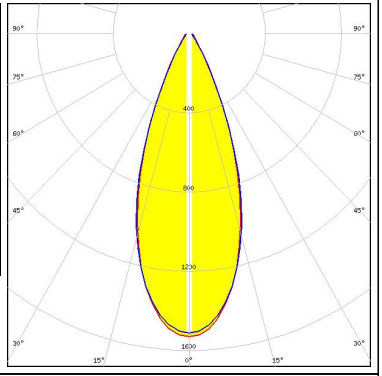

See also our general installation guide: www.ledil.com/installation_guide

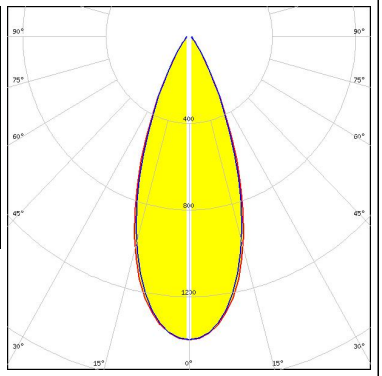
OPTICAL RESULTS (MEASURED):

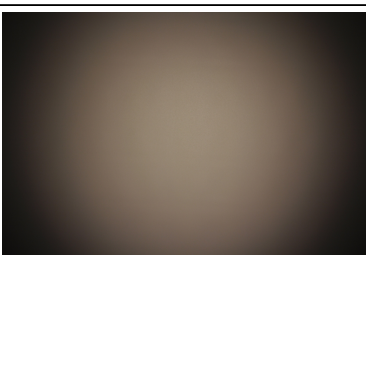
<p>CREE ⇄ LED</p> <p>LED XP-E FWHM / FWTM 40.0° / 70.0° Efficiency 90 % Peak intensity 1.5 cd/m LEDs/each optic 1 Light colour White Required components:</p>		
<p>CREE ⇄ LED</p> <p>LED XP-G FWHM / FWTM 40.0° / 68.0° Efficiency 90 % Peak intensity 1.4 cd/m LEDs/each optic 1 Light colour White Required components:</p>		
<p>CREE ⇄ LED</p> <p>LED XP-G2 FWHM / FWTM 40.0° / 68.0° Efficiency 87 % Peak intensity 1.8 cd/m LEDs/each optic 1 Light colour White Required components:</p>		
<p>CREE ⇄ LED</p> <p>LED XP-L HD FWHM / FWTM 46.0° / 76.0° Efficiency 84 % Peak intensity 1.4 cd/m LEDs/each optic 1 Light colour White Required components:</p>		

OPTICAL RESULTS (MEASURED):



LED XT-E
 FWHM / FWTM 39.0° / 68.0°
 Efficiency %
 Peak intensity 1.7 cd/lm
 LEDs/each optic 1
 Light colour White
 Required components:

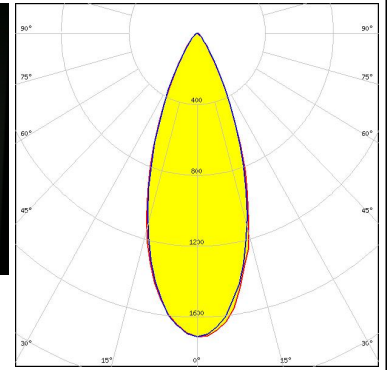

LED LUXEON A
 FWHM / FWTM 41.0°
 Efficiency 77 %
 LEDs/each optic 1
 Light colour White
 Required components:



LED LUXEON Rebel
 FWHM / FWTM 38.0°
 Efficiency 77 %
 LEDs/each optic 1
 Light colour White
 Required components:

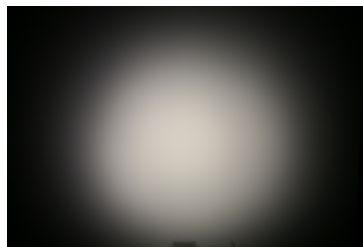

LED LUXEON Rebel ES
 FWHM / FWTM 41.0°
 Efficiency 77 %
 LEDs/each optic 1
 Light colour White
 Required components:

OPTICAL RESULTS (MEASURED):

LUMILEDS

LED LUXEON T
 FWHM / FWTM 42.0° / 70.0°
 Efficiency 86 %
 Peak intensity 1.6 cd/m
 LEDs/each optic 1
 Light colour White
 Required components:

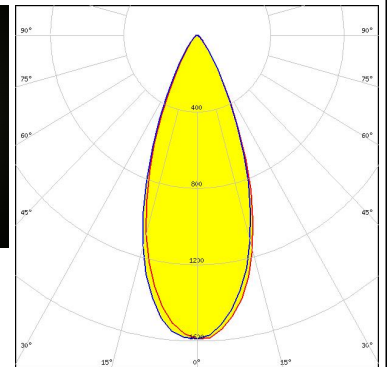
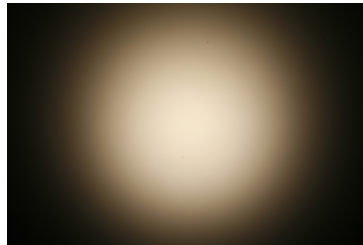

LUMILEDS

LED LUXEON TX
 FWHM / FWTM 40.0° / 67.0°
 Efficiency 85 %
 Peak intensity 1.7 cd/m
 LEDs/each optic 1
 Light colour White
 Required components:

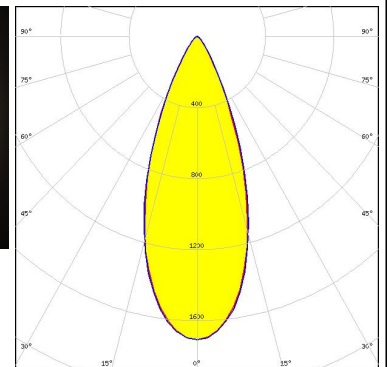
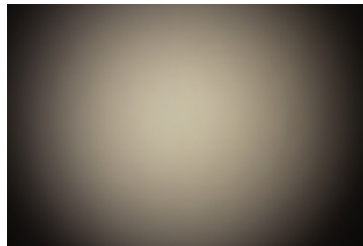

NICHIA

LED NCSxx19A
 FWHM / FWTM 39.0°
 Efficiency 84 %
 LEDs/each optic 1
 Light colour White
 Required components:

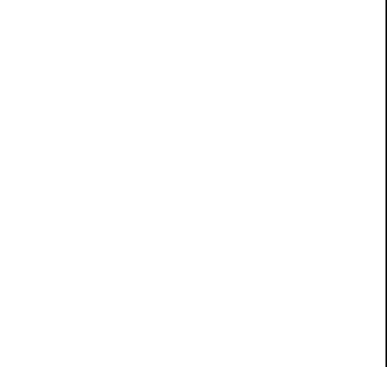

NICHIA

LED NCSxx19B
 FWHM / FWTM 38.0° / 67.0°
 Efficiency 85 %
 Peak intensity 1.8 cd/m
 LEDs/each optic 1
 Light colour White
 Required components:

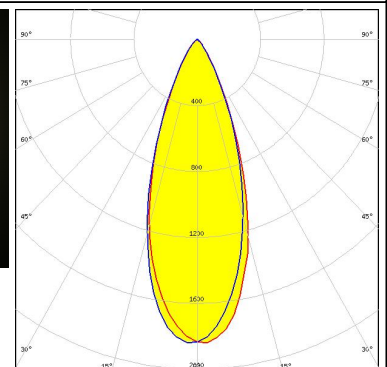
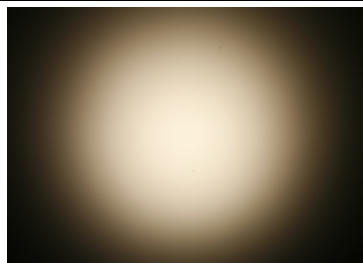

OPTICAL RESULTS (MEASURED):

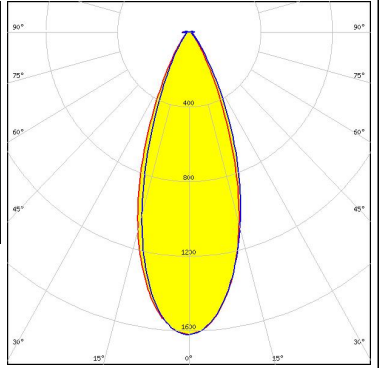
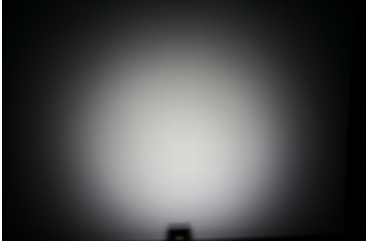
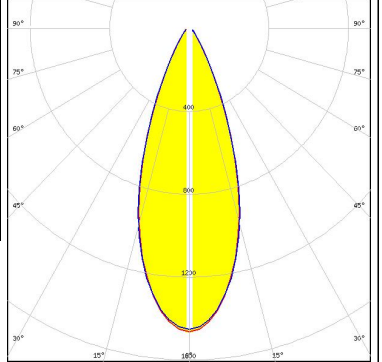
<p>NICHIA</p> <p>LED NVSxx19A FWHM / FWTM 38.0° / 68.0° Efficiency 90 % Peak intensity 1.6 cd/lm LEDs/each optic 1 Light colour White Required components:</p>		
<p>OSRAM Opto Semiconductors</p> <p>LED OSLOM Square EC FWHM / FWTM 36.0° / 66.0° Efficiency 78 % Peak intensity 1.9 cd/lm LEDs/each optic 1 Light colour White Required components:</p>		
<p>OSRAM Opto Semiconductors</p> <p>LED OSLOM SSL 150 FWHM / FWTM 40.0° Efficiency 83 % LEDs/each optic 1 Light colour White Required components:</p>		
<p>OSRAM Opto Semiconductors</p> <p>LED OSLOM SSL 80 FWHM / FWTM 40.0° Efficiency 83 % LEDs/each optic 1 Light colour White Required components:</p>		

OPTICAL RESULTS (MEASURED):

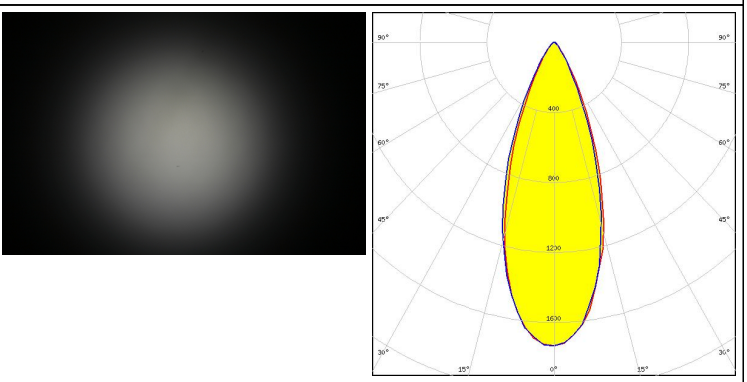
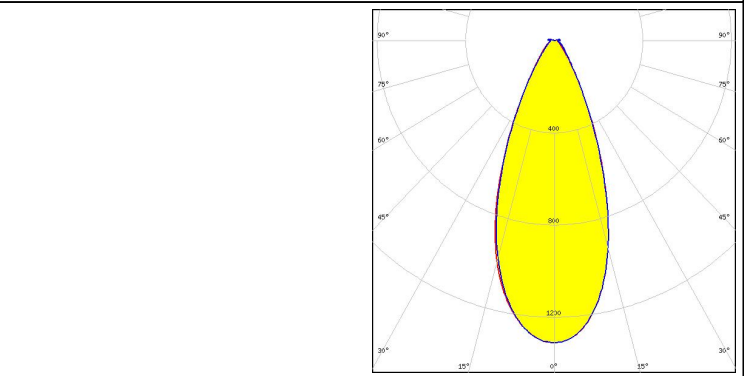
<p>SEOUL SEOUL SEMICONDUCTOR</p> <p>LED Z5 FWHM / FWTM 40.0° Efficiency % LEDs/each optic 1 Light colour White Required components:</p>	
<p>SEOUL SEOUL SEMICONDUCTOR</p> <p>LED Z5M1/Z5M2 FWHM / FWTM 38.0° / 67.0° Efficiency 84 % Peak intensity 1.7 cd/lm LEDs/each optic 1 Light colour White Required components:</p>	
<p>TOSHIBA Leading Innovation >>></p> <p>LED TL1L3 FWHM / FWTM 42.0° / 75.0° Efficiency 90 % Peak intensity 1.3 cd/lm LEDs/each optic 1 Light colour White Required components:</p>	

OPTICAL RESULTS (SIMULATED):

CREE → LED

LED XHP35 HD
 FWHM / FWTM 45.0° / 65.0°
 Efficiency 90 %
 Peak intensity 1.6 cd/lm
 LEDs/each optic 1
 Light colour White
 Required components:

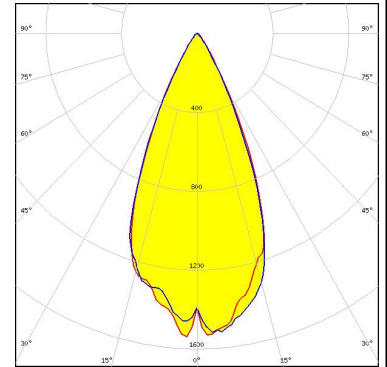

CREE → LED

LED XHP35 HI
 FWHM / FWTM 41.0° / 56.0°
 Efficiency 93 %
 Peak intensity 2.3 cd/lm
 LEDs/each optic 1
 Light colour White
 Required components:

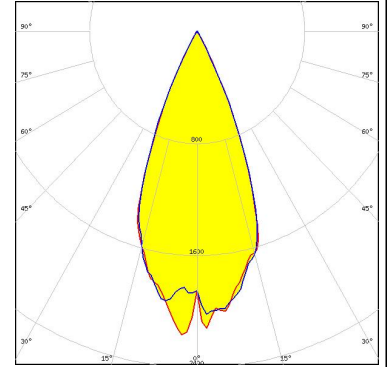

CREE → LED

LED XP-G3
 FWHM / FWTM 44.0° / 67.0°
 Efficiency 94 %
 Peak intensity 1.7 cd/lm
 LEDs/each optic 1
 Light colour White
 Required components:

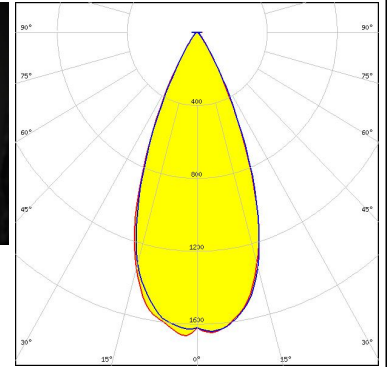
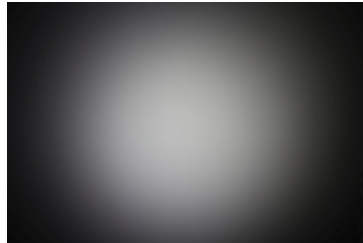

CREE → LED

LED XT-E HVW
 FWHM / FWTM 40.0°
 Efficiency %
 LEDs/each optic 1
 Light colour White
 Required components:

OPTICAL RESULTS (SIMULATED):

LUMILEDS

LED LUXEON H50-2
FWHM / FWTM 41.0° / 59.0°
Efficiency 90 %
Peak intensity 2.1 cd/lm
LEDs/each optic 1
Light colour White
Required components:

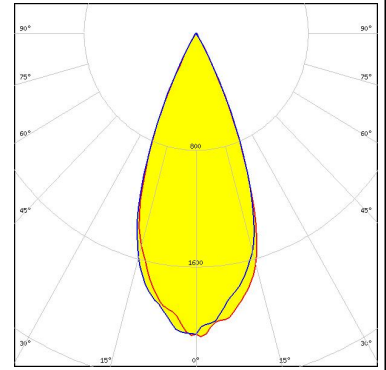

NICHIA

LED NVSxx19B/NVSxx19C
FWHM / FWTM 41.0° / 61.0°
Efficiency 92 %
Peak intensity 1.9 cd/lm
LEDs/each optic 1
Light colour White
Required components:

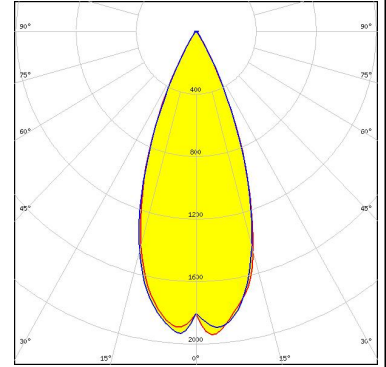

SAMSUNG

LED LH351B
FWHM / FWTM 44.0° / 66.0°
Efficiency 95 %
Peak intensity 1.7 cd/lm
LEDs/each optic 1
Light colour White
Required components:

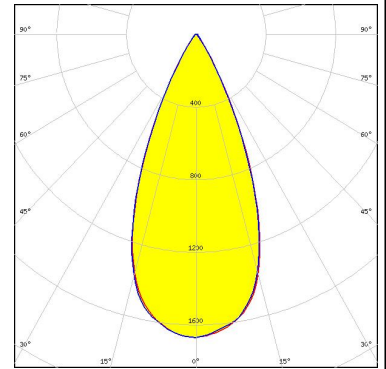

GENERAL INFORMATION:

NOTE: The typical beam angle will be changed by different color, chip size and chip position tolerance. The typical total beam angle is the full angle measured where the luminous intensity is half of the peak value.

MATERIALS:

As part of our continuous research and improvement processes, and to ensure the best possible quality and availability of our products, LEDiL reserves the right to change material grades without notice.

PRODUCT DATA USER AGREEMENT AND DISCLAIMER:

The measured data in the provided downloadable LEDiL Product Datasheets and Mechanical 2D-Drawings is rounded and provided as reference for planning. LEDiL Oy's optical specifications have been verified by conducting performance testing of the products in accordance with the company's quality system. The reported data are averaged results of multiple measurements with typical variation. LEDiL Oy reserves the right to without prior notification make changes and improvements to its products.

LEDiL Oy assumes neither warranty, nor guarantee nor any other liability of any kind for the contents and correctness of the provided data. The provided data has been generated with highest diligence but the provided data may in reality not represent the complete possible variation range of all intrinsic parameters. Therefore, in certain cases a deviation from the provided data could occur.

LEDiL Oy reserves the right to undertake technical changes of its products without further notification which could lead to changes in the provided data. LEDiL Oy assumes no liability of any kind for the possible deviation from any provided data or any other damage resulting from the usage of the provided data.

The user agrees to this disclaimer and user agreement with the download or usage of the provided files.

LEDiL Oy

Joensuunkatu 13
FI-24240 SALO
Finland

LEDiL Inc.

228 West Page Street
Suite D
Sycamore IL 60178
USA

Ledil Optics Technology (Shenzhen) Co., Ltd.

405 , Block B
Casic Motor Building
Shenzhen 518057
P.R.CHINA

Local sales and technical support

[www.ledil.com/
where_to_buy](http://www.ledil.com/where_to_buy)

Shipping locations

Salo, Finland
Hong Kong, China

Distribution Partners

[www.ledil.com/
where_to_buy](http://www.ledil.com/where_to_buy)