

# MATERIALS & SPECIFICATIONS

PART NO.	A24001-008	REV	ECO	DATE	APP
		E	102048	11-03-15	TLM

## INSULATOR:

POLYPHENYLENE SULFIDE (PPS)  
PER MIL-M-24519, TYPE GST  
40F.

## CONTACT:

BERYLLIUM COPPER PER ASTM  
B194, C17200. GOLD PLATED  
PER ASTM B488, (HARD GOLD)  
TYPE II CODE C CLASS 1.27.

## TERMINATION:

SOLDER COATED WITH SN63A PER  
J-STD-006 OR AMS-P-81728.

## LATCH BOX:

BERYLLIUM COPPER PER ASTM  
B194 NICKEL PLATE PER SAE-  
AMS-2404.

## CURRENT CAPACITY:

3 AMP MAX.

## CONTACT RESISTANCE:

26 MILLIOHMS (65mV) MAX @  
2.5 AMPS.

## PERFORMANCE:

PRODUCT FAMILY TESTED TO AND  
PASSED THE PERFORMANCE  
SPECIFICATIONS OF TABLE VII OF  
MIL-DTL-83513.



ACTUAL SIZE

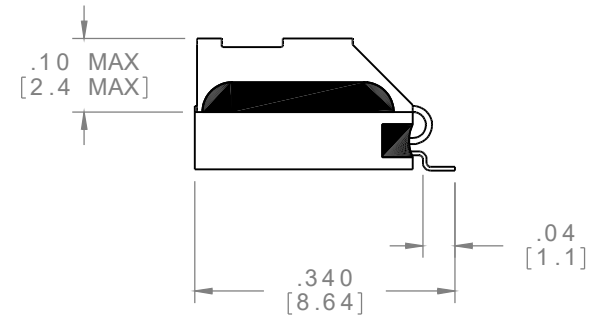
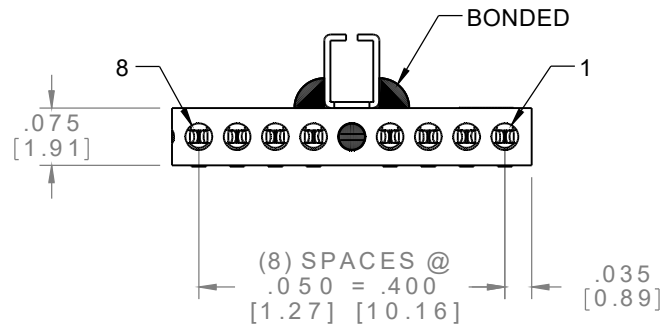
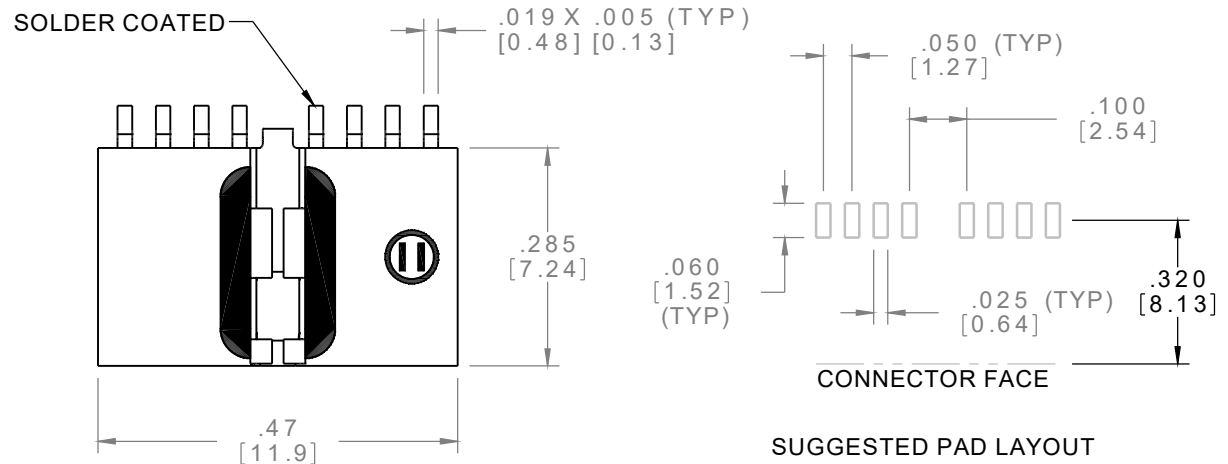

## NOTE:

DIMENSIONS IN [ ] ARE IN  
MILLIMETERS UNLESS  
OTHERWISE NOTED AND ARE  
FOR REFERENCE ONLY

PS1 SLDW	THIRD ANGLE
	-TOLERANCES-
	UNLESS OTHERWISE NOTED
	DIMENSIONS IN INCHES
2	PL DEC ± .01
3	PL DEC ± .005
4	PL DEC ± .0005
	ANGLES ± 1°

THIS DRAWING CONTAINS CONFIDENTIAL AND PROPRIETARY INFORMATION WHICH IS THE PROPERTY OF OMNETICS CONNECTOR CORP. THIS DOCUMENT MAY NOT, IN WHOLE OR IN PART, BE DUPLICATED, OR DISCLOSED FOR ANY PURPOSE, WITHOUT WRITTEN PERMISSION FROM OMNETICS CONNECTOR CORP.	
DFTM. DEL	DATE 09-26-02
CHK'D.	DATE
APP'D.	DATE
TITLE: (8) PIN MALE CONNECTOR W/LATCH	

**OMNETICS**  
CONNECTOR CORPORATION  
7260 COMMERCE CIRCLE EAST  
MINNEAPOLIS, MN 55432  
WWW.OMNETICS.COM

CAGE CODE 61873	
DWG NO. A24001-008	
SHEET 1 OF 1	REV E
SCALE: 4:1	