

**Ratings**

Voltage: 600 V  
 Temperature: -40~105 °C  
 Flammability: FT2

**Conductor**

Conductor count: 4  
 Gauge: 28 AWG 0.08 mm<sup>2</sup>  
 Material: tinned copper strands  
 Strand size: Ø 0.12 mm x 7  
 Resistance at 20 °C: 250 Ω /km max

**Insulator**

Material: mPPE  
 Color: red, black, white, yellow  
 Diameter: Ø 0.9 ±0.08 mm  
 Average thickness: 0.25 mm  
 Minimum thickness: 0.2 mm  
 Resistance at 20 °C: 100 MΩ /km min

**Shield**

Type: foil  
 Material: aluminum mylar  
 Coverage: 100%

**Outer jacket**

Material: mPPE, 85A  
 Color: black  
 Diameter: Ø 3.9 ±0.15 mm  
 Average thickness: 0.81 mm  
 Minimum thickness: 0.57 mm

**Wire marking:** E339579 UL AWM STYLE 21509 28 AWG 105°C 600V --- cUL AWM I A 105°C 600V FT2 TENSILITY

**Bend radius**

Minimum: 6 times diameter (23.4 mm)

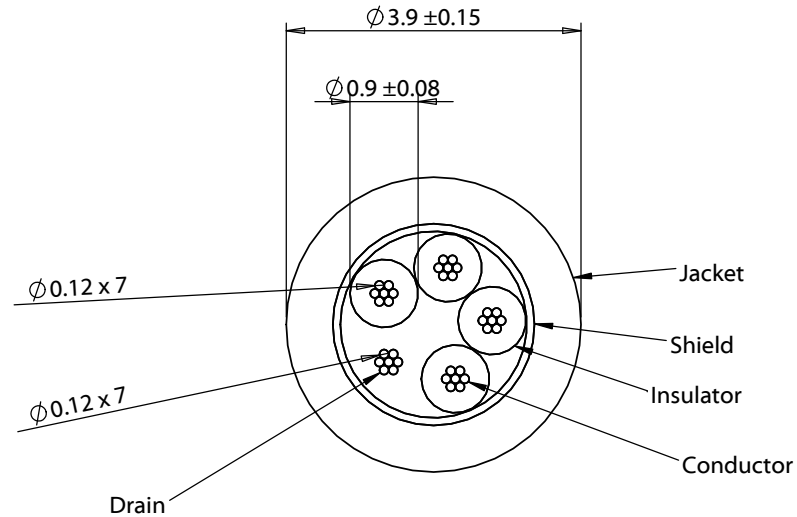
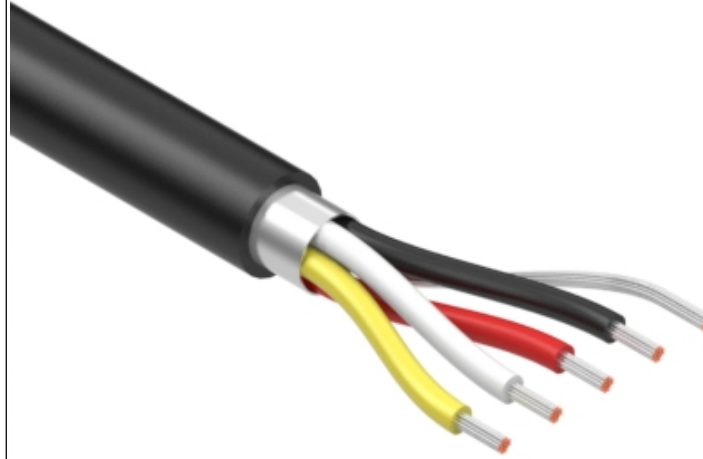

Revision:	Date:	Description:	Prepared:	Notes: RoHS compliant Phthalate and halogen free	<h1>TENSILITY</h1> <p>tel 1.541.323.3228 800 877.670.7118                  fax 1.541.323.4202 web tensility.com</p>	
A	4/20/2020	Initial release	Verified:			
			Dimensions are in millimeters. Tolerances: X: ± 0.5 mm X.X: ± 0.3 mm X.XX: ± 0.05 mm	Description:	Size: Part number:	
				Wire, 4C TS, 28 AWG, 21509, 600V, 105C, 3.9 mm, shielded, FT2, mPPE	A 30-01444	
				Scale: 10:1		Sheet 1 of 1

5

4

3

2

1