

| TOLERANCE<br>UNLESS OTHERWISE<br>SPECIFIED |       |
|--|-------|
| .X   | ±0.25 |
| .XX  | ±0.13 |
| .XXX                                       | ±0.05 |

THIS IS A C.A.D. GENERATED DRAWING  
DO NOT MAKE MANUAL REVISIONS TO MASTER.

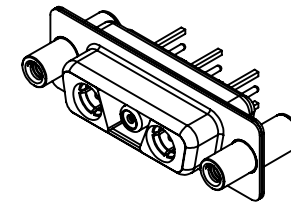

| ISSUE NUMBER |   |
|--------------|---|
| ORIGINAL     | ① |

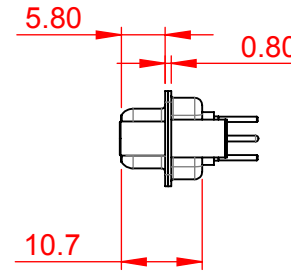
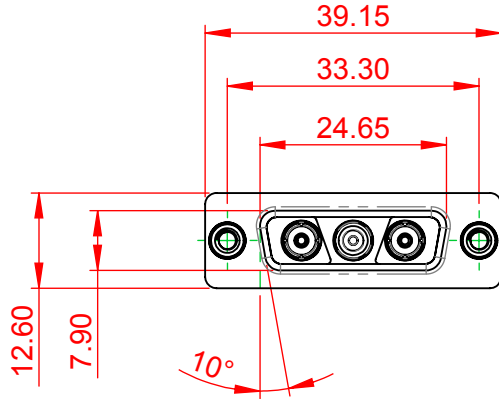

**NOTES:**

**MATERIAL:**

**HOUSING:** THERMOPLASTIC POLYESTER, UL94V-0

**SHELL:** STEEL, Sn or Ni PLATED

**CONTACT:** COPPER ALLOY SEE ORDERING GUIDE FOR PLATING

**OPERATING TEMPERATURE:** -55°C ~ 125°C

**SIGNAL CONTACT CURRENT RATING:** 5A PER CONTACT

**SIGNAL CONTACT RESISTANCE:** 10mΩ MAX.

**INSULATOR RESISTANCE:** 5000MΩ min.

**DIELECTRIC**

**WITHSTANDING VOLTAGE:** 1000V AC rms

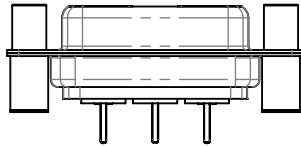

THIS SERIES FULLY CONFORMS TO  
THE EUROPEAN UNION DIRECTIVES  
2011/65/EU FOR RoHS COMPLIANCY.



YOUR CONNECTION TO QUALITY & SERVICE

EDAC INC  
TORONTO, ONTARIO  
CANADA

THESE DRAWINGS AND SPECIFICATIONS  
ARE THE PROPERTY OF EDAC INC., AND  
SHALL NOT BE REPRODUCED, OR COPIED  
OR USED AS THE BASIS FOR THE  
MANUFACTURE OR SALE OF APPARATUS  
WITHOUT WRITTEN PERMISSION.

**COMBINATION D-SUB**

|                                      |                    |
|--------------------------------------|--------------------|
| SW REFERENCE NO.: 628 COMBO ASSEMBLY |                    |
| DRAWN: C.B                           | DATE: JAN. 01/2019 |
| CHECKED:                             | DATE:              |
| SCALE: (IN C.A.D. 1:1)               | SHEET 1 OF 4       |
| DRAWING NUMBER: 628-3WK3624-5TC      | ISSUE              |
| PART NUMBER: 628-3WK3624-5TC         | 1                  |

| TOLERANCE<br>UNLESS OTHERWISE<br>SPECIFIED |       |
|--|-------|
| .X   | ±0.25 |
| .XX  | ±0.13 |
| .XXX                                       | ±0.05 |

THIS IS A C.A.D. GENERATED DRAWING  
DO NOT MAKE MANUAL REVISIONS TO MASTER.



|              |   |
|--------------|---|
| ISSUE NUMBER |   |
| ORIGINAL     | ① |



|  |  |                                      |                    |
|--|--|--------------------------------------|--------------------|
| <b>COMBINATION D-SUB</b>   |  | SW REFERENCE NO.: 628 COMBO ASSEMBLY |                    |
|  |  | DRAWN: C.B                           | DATE: JAN. 01/2019 |
|  <b>EDAC INC</b><br>TORONTO, ONTARIO<br>CANADA<br>YOUR CONNECTION TO QUALITY & SERVICE  |  | CHECKED:                             |                    |
|  |  | DATE:                                |                    |
| THESE DRAWINGS AND SPECIFICATIONS<br>ARE THE PROPERTY OF EDAC INC., AND<br>SHALL NOT BE REPRODUCED, OR COPIED<br>OR USED AS THE BASIS FOR THE<br>MANUFACTURE OR SALE OF APPARATUS<br>WITHOUT WRITTEN PERMISSION. |  | SCALE: N.T.S                         | SHEET 2 OF 6       |
|  |  | DRAWING NUMBER: 628-3WK3624-5TC      | ISSUE 1            |
|  |  | PART NUMBER: 628-3WK3624-5TC         |                    |



THIS SERIES FULLY CONFORMS TO  
THE EUROPEAN UNION DIRECTIVES  
2011/65/EU FOR RoHS COMPLIANCY.

| TOLERANCE<br>UNLESS OTHERWISE<br>SPECIFIED |       |
|--|-------|
| .X   | ±0.25 |
| .XX  | ±0.13 |
| .XXX                                       | ±0.05 |

THIS IS A C.A.D. GENERATED DRAWING  
DO NOT MAKE MANUAL REVISIONS TO MASTER.



ISSUE NUMBER

ORIGINAL

1

2W2 / 2WK2



3W3 / 3WK3



5W1 Male/Female



24W7 Male/Female



5W5 Male



8W8 Male



7W2 Male/Female



21W4 Male/Female

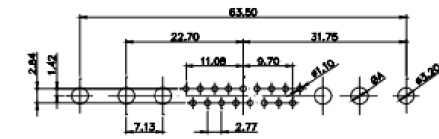

5W5 Female



8W8 Female



11W1 Male/Female



27W2 Male/Female

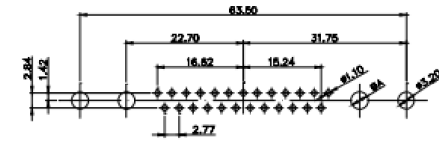

CURRENT RATING /  $\phi$ A

- 10A / 2.2
- 20A / 3.3
- 30A / 3.7
- 40A / 4.2

17W2 Male/Female



21W1 Male/Female



THIS SERIES FULLY CONFORMS TO  
THE EUROPEAN UNION DIRECTIVES  
2011/65/EU FOR RoHS COMPLIANCY.



YOUR CONNECTION TO QUALITY & SERVICE

COMBINATION D-SUB

EDAC INC  
TORONTO, ONTARIO  
CANADA

THESE DRAWINGS AND SPECIFICATIONS  
ARE THE PROPERTY OF EDAC INC., AND  
SHALL NOT BE REPRODUCED, OR COPIED  
OR USED AS THE BASIS FOR THE  
MANUFACTURE OR SALE OF APPARATUS  
WITHOUT WRITTEN PERMISSION.

|                                      |                    |
|--------------------------------------|--------------------|
| SW REFERENCE NO.: 628 COMBO ASSEMBLY |                    |
| DRAWN: C.B                           | DATE: JAN. 01/2019 |
| CHECKED:                             | DATE:              |
| SCALE: N.T.S                         | SHEET 3 OF 4       |
| DRAWING NUMBER: 628-3WK3624-5TC      | ISSUE<br>1         |
| PART NUMBER: 628-3WK3624-5TC         |                    |

| TOLERANCE<br>UNLESS OTHERWISE<br>SPECIFIED |       |
|--|-------|
| .X   | ±0.25 |
| .XX  | ±0.13 |
| .XXX                                       | ±0.05 |

THIS IS A C.A.D. GENERATED DRAWING  
DO NOT MAKE MANUAL REVISIONS TO MASTER.



|              |   |
|--------------|---|
| ISSUE NUMBER | 1 |
| ORIGINAL     |   |

9W4 Male



25W3 Male



9W4 Female



25W3 Female



13W3 Male



36W4 Male



13W3 Female



36W4 Female



13W6 Male



43W2 Male



13W6 Female



43W2 Female



17W5 Male



47W1 Male



17W5 Female

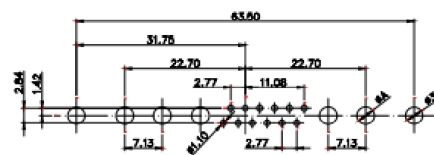

47W1 Female



THIS SERIES FULLY CONFORMS TO  
THE EUROPEAN UNION DIRECTIVES  
2011/65/EU FOR RoHS COMPLIANCY.



YOUR CONNECTION TO QUALITY & SERVICE

COMBINATION D-SUB

EDAC INC  
TORONTO, ONTARIO  
CANADA

THESE DRAWINGS AND SPECIFICATIONS  
ARE THE PROPERTY OF EDAC INC., AND  
SHALL NOT BE REPRODUCED, OR COPIED  
OR USED AS THE BASIS FOR THE  
MANUFACTURE OR SALE OF APPARATUS  
WITHOUT WRITTEN PERMISSION.

|                                      |                    |
|--------------------------------------|--------------------|
| SW REFERENCE NO.: 628 COMBO ASSEMBLY |                    |
| DRAWN: C.B                           | DATE: JAN. 01/2019 |
| CHECKED:                             | DATE:              |
| SCALE: N.T.S                         | SHEET 4 OF 4       |
| DRAWING NUMBER: 628-3WK3624-5TC      | ISSUE<br>1         |
| PART NUMBER: 628-3WK3624-5TC         |                    |