

MOTOR SPECIFICATIONS

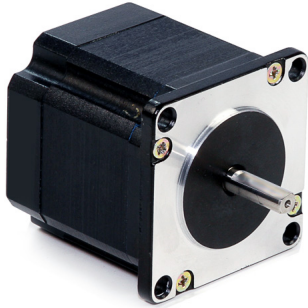

DIMENSIONS

Part Number	WO-5718L-01S
Step Angle	1.8°
Frame Size	NEMA 23
Body Length (Dim. A)	3.1 in (78.7 mm)
Current	1.4 Amps/Phase
Holding Torque	294 oz-in (2.08 Nm)
Resistance	4.5 Ohms/Phase
Rotor Inertia	2.6 oz-in ²
Number of Leads	4
Connection	Serial
Weight	2.35 lbs (1.07 kg)

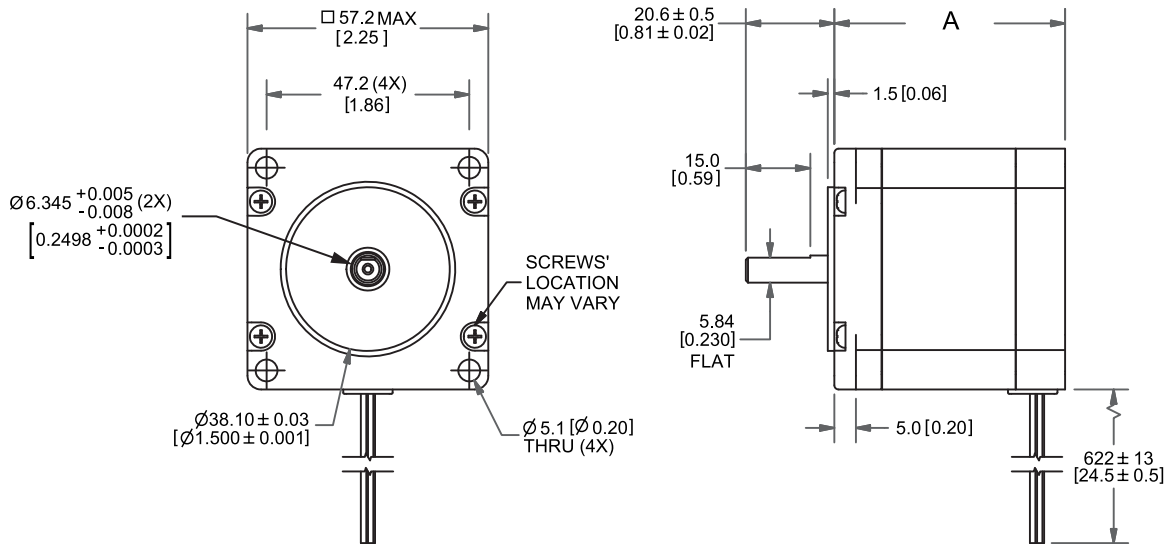

PERFORMANCE CURVE

5718L-01S 24VDC, 1.4 Amps/Phase, Bipolar Series, 1/2 Stepping
 5718L-01P 24VDC, 2.8 Amps/Phase, Bipolar Parallel, 1/2 Stepping

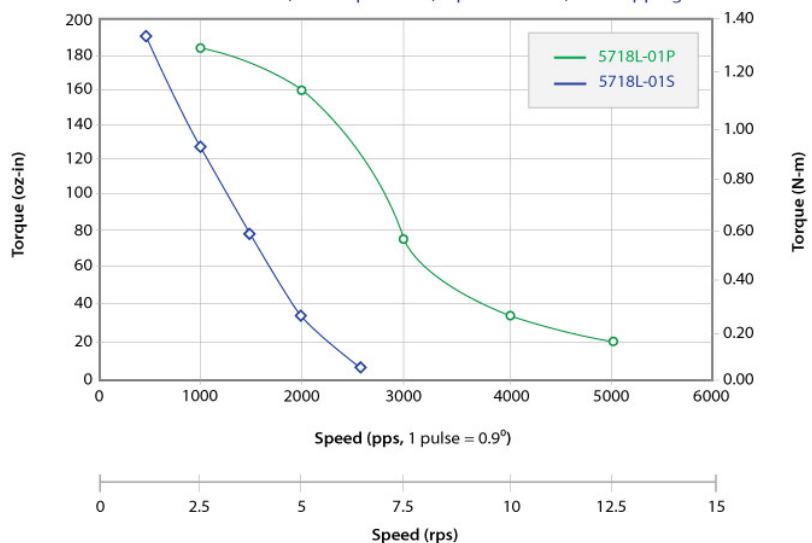

OPERATING SPECIFICATIONS

Radial Play	0.001" max @ 1 lbs load
End Play	0.003" max @ 2 lbs load
Shaft Run Out	0.002" TIR
Concentricity of Mounting Pilot to Shaft	0.003" TIR
Perpendicularity of Shaft to Mounting Face	0.003" TIR
Max Axial Load	13 lbs
Maximum Case Temperature	80 C
Ambient Temperature	-20° to 50° C
Storage Temperature	-20° to 100° C
Humidity Range	85% or less, non-condensing
Magnet Wire Insulation	Class B 130° C
Insulation Resistance	100MΩ at 500 VDC
Dielectric Strength	500 VAC for 1 minute

WIRING TABLE

COLOR	FUNCTION
Red	A+ Phase
Blue	A- Phase
Green	B + Phase
Black	B- Phase

OPERATION & USAGE TIPS

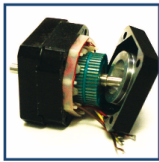

Do not disassemble motors; a significant reduction in motor performance will occur.

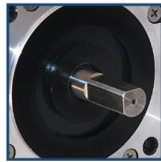

Do not machine shafts; this will have a negative effect on shaft run out and perpendicularity.

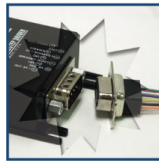

Do not disconnect motor from drive while in operation.

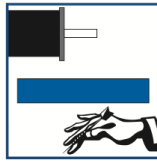

Do not use holding torque/detent torque of motor as a fail safe brake.



Do not hold motor by lead wires.



Do not exceed the rated current; this will burn the motor.

FAILURE TO COMPLY WITH THESE RECOMMENDATIONS WILL VOID ALL WARRANTY TERMS

RECOMMENDED



Single Axis Driver
R325P



Single Axis Controller+Driver
R356

Motion Control, **Solved.**

MOTOR ENGINEERING & MANUFACTURING



Optimized
For Your
Application



Quick
Prototype
Turnaround



Small Batch
to OEM Volume
Production



US Based
Support &
Manufacturing