

GROMMETS & BUSHINGS/LED SPACERS & INSULATORS

MCG

Metal Continuous Grommet

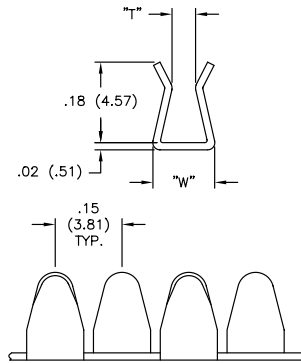
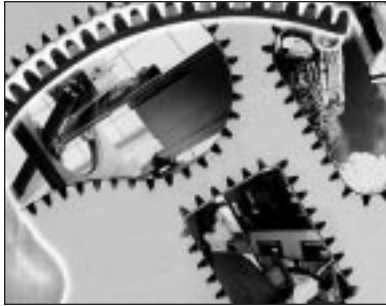

Features:

Heat Continuous:
290 degrees F
(145 degrees C)

Salt Spray:
2000 hours per MIL-STD-202D; Method: 101D

Dielectric (per MIL-STD-202; Method 301):
MCG-XE - 750 volts @ 60Hz
MCG-XN - 1000 volts @ 60Hz

Abrasion (MCG-XN only):
ASTM D1044 CS17 Wheel
1000g Weight
0.008g Loss 5000 Cycles

Shock and Vibration:

MIL-STD-1344, Method 2005
Test Condition VI Letter J.
Duration: 8 hours in the longitudinal and 8 hours in the perpendicular direction.
Shock: Overall RMS: G41.7

Flammability:

MCG-XE - UL 746C
(exceeds UL 94-V0)
MCG-XN - UL 94-V0

NOTE:
Hand held cutting tool needed, order part number MCGS-1

Material: 300 Series Stainless Steel with coating options

100 ft Reel Epoxy Coated Color: Green*	100 ft Reel Fusion Bonded Nylon 11 Coated Color: Black	"W"	"T" Application Thickness
MCG-1E	MCG-1N	.14 (3.6)	.025 (0.64) - .036 (0.91)
MCG-2E	MCG-2N		.037 (0.93) - .055 (1.40)
MCG-3E	MCG-3N		.056 (1.42) - .074 (1.90)
MCG-4E	MCG-4N	.18 (4.6)	.075 (1.91) - .093 (2.36)
MCG-6E	MCG-6N		.113 (2.87) - .134 (3.40)

*Discontinued stock in Brown color with the Epoxy coating will be sold until stock is depleted.

MCCG

Metal Continuous Cushioned Grommet

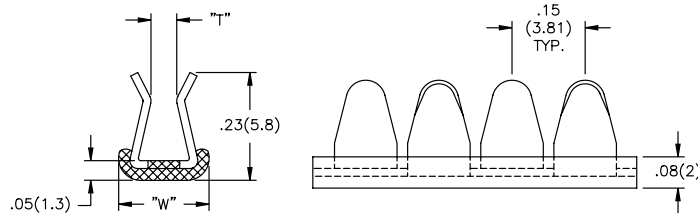

NOTE:
Hand held cutting tool needed, order part number MCGS-1

Material: 300 Series Stainless Steel with Fusion Bonded Nylon 11 Coating and a 46 Durometer, Shore D Cushion

100 ft Reel Color: Black	"W"	"T" Application Thickness
MCCG-1N	.19 (4.8)	.025 (0.64) - .036 (0.91)
MCCG-2N		.037 (0.93) - .055 (1.40)
MCCG-3N		.056 (1.42) - .074 (1.90)
MCCG-4N	.22 (5.6)	.075 (1.91) - .093 (2.36)
MCCG-6N		.113 (2.87) - .134 (3.40)

*Extra flexible grommet is available by special order.

Applications

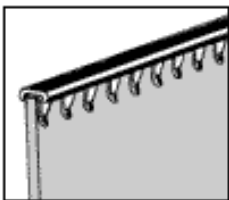

Cushion

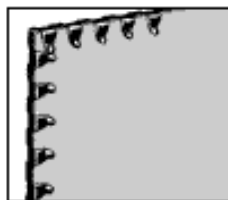

Outside Right Angles

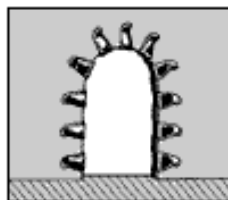

U-Shape (Mouse Hole)

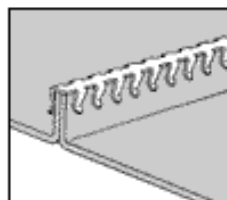

Grounding Clip (EMI/RFI)
Uncoated part only



Continuous Straight Edge

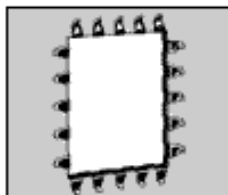

Inside Right Angles



Irregular Holes



Flexible Grommet*

Features:

Heat Continuous:
185 degrees F (85 degrees C)

Salt Spray:
2000 hours per MIL-STD-202D
Method: 101D

Dielectric:
1200 volts @ 60Hz per MIL-STD-202; Method 301.

Shock and Vibration:
MIL-STD-1344, Method 2005
Test Condition VI Letter J.
Duration: 8 hours in the longitudinal and 8 hours in the perpendicular direction.
Shock: Overall RMS: G41.7

Flammability: UL 94-V0