

Data sheet | Item number: 288-380

Bistable relay module; Nominal input voltage: 24 VDC; 1 changeover contact;
Limiting continuous current: 6 A; Module width: 21 mm; 2,50 mm²; gray

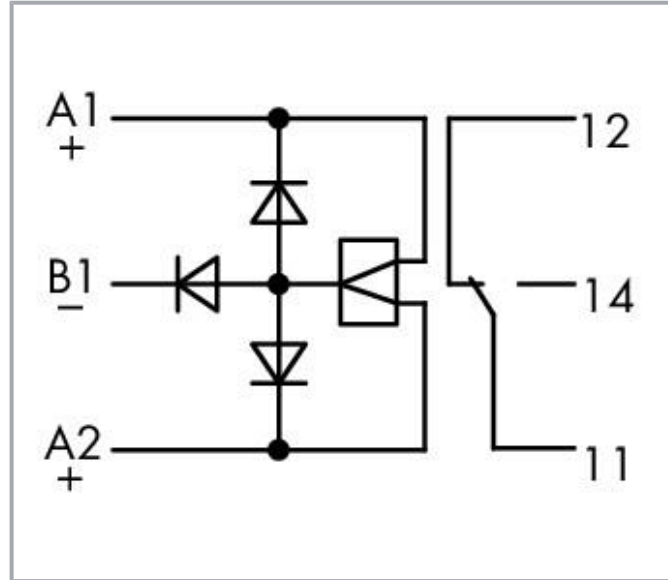

www.wago.com/288-380



Subject to changes. Please also observe the further product documentation!

WAGO GmbH & Co. KG
Hansastr. 27
32423 Minden
Phone: +49571 887-0 | Fax: +49571 887-169
Email: info.de@wago.com | Web: www.wago.com

Do you have any questions about our products?
We are always happy to take your call at +49 (571) 887-44222.

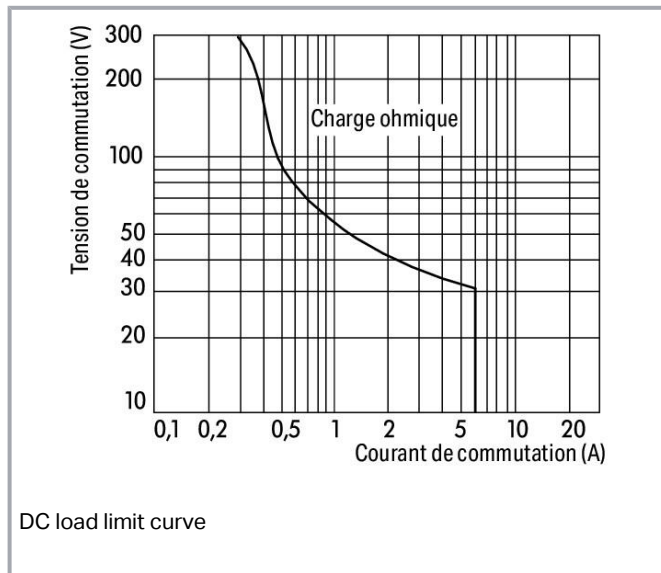

Data

Technical data

Control Circuit

Nominal input voltage U_N	DC 24 V
Input voltage range	-15 ... +20 %
Nominal input current at U_N	51 mA
Functions	Set (closed 11-14 contacts): A1 Reset (closed 11-12 contacts): A2

Load circuit

Number of changeover/switchover contacts	1
Contact material (relay)	AgNi 90/10
Limiting continuous current	6 A
Inrush current (resistive) max.	(AC) 30 A / 4 s
Switching voltage (max.)	AC 250 V
Switching power (resistive) max.	AC 1500 VA
Pull-in time (typ.)	10 ms
Drop-out time (typ.)	10 ms
Bounce time (typ.)	6 ms
Electrical life (NO; resistive load; 23 °C)	10 x 10 ³ switching operations

Subject to changes. Please also observe the further product documentation!



Safety and protection

Rated voltage	300 V
Overvoltage category	II
Pollution degree	2
Dielectric strength (control/load circuit) (AC, 1 min)	4 kVrms
Dielectric strength (open contact) (AC, 1 min)	1 kVrms
Insulation type (control/load circuit)	Reinforced insulation (safe isolation)
Insulation type (adjacent devices)	Reinforced insulation (safe isolation)

Connection data

Connection technology	CAGE CLAMP®
WAGO connector	WAGO 236 Series
Solid conductor	0.08 ... 2.5 mm ² / 28 ... 12 AWG
Fine-stranded conductor	0.08 ... 2.5 mm ² / 28 ... 12 AWG
Strip length	5 ... 6 mm / 0.2 ... 0.24 inches

Physical data

Width	20.5 mm / 0.807 inches
Height	85 mm / 3.346 inches
Depth from upper-edge of DIN-rail	48 mm / 1.89 inches

Mechanical data

Mounting type	DIN-35 rail
---------------	-------------

Material Data

Color	gray
Fire load	0.772 MJ
Weight	43.3 g

Environmental requirements

Ambient temperature (operation at U _N)	-25 ... +40 °C
Ambient temperature (storage)	-25 ... +70 °C
Processing temperature	-25 ... +50 °C
Relative humidity	5 ... 75 % (non-condensing)
Operating altitude (max.)	2000 m

Subject to changes. Please also observe the further product documentation!

Standards and specifications

Standards/specifications	EN 61010-2-201
--------------------------	----------------

Commercial data

Product Group	6 (INTERFACE ELECTRONIC)
eCl@ss 10.0	27-37-16-01
eCl@ss 9.0	27-37-16-01
ETIM 8.0	EC001437
ETIM 7.0	EC001437
PU (SPU)	10 (1) pcs
Packaging type	box
Country of origin	DE
GTIN	4045454312336
Customs tariff number	85364900990

Environmental Product Compliance

CAS-No.	7439-92-1 79-94-7
REACH Candidate List Substance	2,2',6,6'-tetrabromo-4,4'-isopropylidenediphenol Lead
RoHS Compliance Status	Compliant,With Exemption
RoHS Exemption	6(c) 7(a) 7(c)-I 7(c)-II
SCIP notification number (Austria)	a5b3ae50-4f44-47f4-95c9-4519509f2abe
SCIP notification number (Belgium)	765615a9-f061-4b0f-a321-ce532a423926
SCIP notification number (Bulgaria)	15b04e1d-5280-424b-aaf1-e50aadce638a
SCIP notification number (Czech Republic)	8cb4fd08-a632-4f45-9e3f-f50d5b96043a
SCIP notification number (Denmark)	6eeb7438-708a-412c-b980-ec3c618a87a5
SCIP notification number (Finland)	5267cfa2-b733-4762-aab1-e457b89475a5
SCIP notification number (France)	bd03b5da-e060-4cf4-8483-32ed9cec555c
SCIP notification number (Germany)	1af4145a-196a-459e-97d1-a835744862de
SCIP notification number (Hungary)	c2761d3f-586f-41f0-8a3c-2dd81381834e
SCIP notification number (Italy)	86e291f0-0375-488d-a188-7873e5c3243b
SCIP notification number (Netherlands)	de4b9e41-df30-4bc0-be4f-6a7b10a1fcb6
SCIP notification number (Poland)	9d3fd4ea-0e20-4daa-92dc-6935748be454

Subject to changes. Please also observe the further product documentation!

WAGO GmbH & Co. KG
 Hansastr. 27
 32423 Minden
 Phone: +49571 887-0 | Fax: +49571 887-169
 Email: info.de@wago.com | Web: www.wago.com

Do you have any questions about our products?
 We are always happy to take your call at +49 (571) 887-44222.

SCIP notification number (Romania)

14491d47-101e-49d0-986f-cfa55dd12d6a

SCIP notification number (Sweden)



18902426-d3fc-4ede-85b7-333d16575c85

Approvals / Certificates

General approvals

Logo	Approval	Additional Approval Text	Certificate name
	EAC Brjansker Zertifizierungsstelle	TP TC 004/2011	EAC RU C-DE.AM02.B.00122/19

Declarations of conformity and manufacturer's declarations

Logo	Approval	Additional Approval Text	Certificate name
	EU-Declaration of Conformity WAGO GmbH & Co. KG	-	-
	UK-Declaration of Conformity WAGO GmbH & Co. KG	-	-

Optional accessories

Tool

Operating tool



Item no.: 210-720

Operating tool; Blade: 3.5 x 0.5 mm; with a partially insulated shaft; multicoloured

www.wago.com/210-720

Marking accessories

Marking strip



Item no.: 709-196

Marking strips; for laser printer; translucent

www.wago.com/709-196

Item no.: 709-178

Marking strips; on reel; 7.5 mm wide; not stretchable; plain; snap-on type; white

www.wago.com/709-178

Subject to changes. Please also observe the further product documentation!

WAGO GmbH & Co. KG

Hansastr. 27

32423 Minden

Phone: +49571 887-0 | Fax: +49571 887-169

Email: info.de@wago.com | Web: www.wago.com

Do you have any questions about our products?

We are always happy to take your call at +49 (571) 887-44222.



Item no.: 709-177

Marking strips; on reel; 7.5 mm wide; not stretchable; plain; snap-on type; translucent

www.wago.com/709-177

Downloads

Documentation

Bid Text

288-380 docx - Datei	2019 Feb 20	docx 16.4 kB	Download
-------------------------	-------------	-----------------	----------

288-380 X81 - Datei	2019 Feb 19	xml 4.0 kB	Download
------------------------	-------------	---------------	----------

Instruction Leaflet

		pdf 1.3 MB	Download
--	--	---------------	----------

Additional Information

Disposal and Recycling Electrical and electronic equipment, Batteries, Packaging	V 1.1.0 2022 Aug 18	pdf 2.2 MB	Download
---	------------------------	---------------	----------

CAD/CAE-Data

CAE data

EPLAN Data Portal 288-380		URL	Download
---------------------------	--	-----	----------

WSCAD Universe 288-380		URL	Download
------------------------	--	-----	----------

Environmental Product Compliance

Compliance Search

Environmental Product Compliance 288-380		URL	Download
--	--	-----	----------

Bistable relay module; Nominal input voltage: 24 VDC; 1 changeover contact; Limiting continuous current: 6 A; Module width: 21 mm; 2,50 mm²; gray

Subject to changes. Please also observe the further product documentation!

Installation Notes

Conductor termination

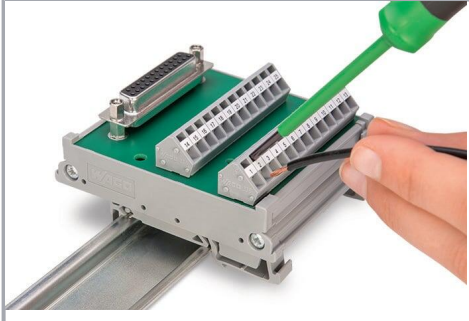

Conductor termination – screwdriver actuation parallel to conductor entry

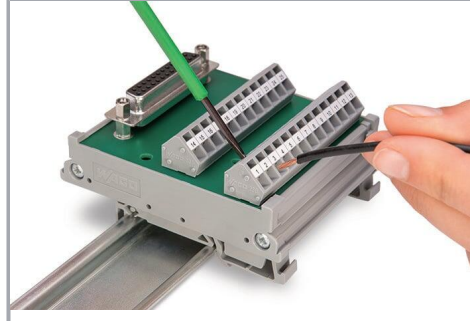

Conductor termination – screwdriver actuation perpendicular to conductor entry

Installation

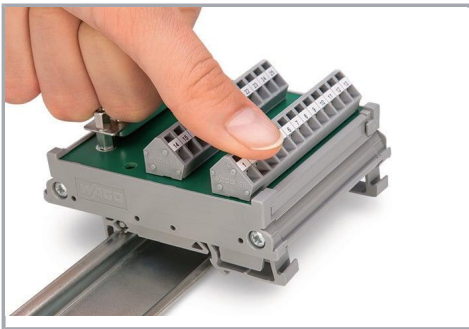

Snapping a module onto DIN-rail.

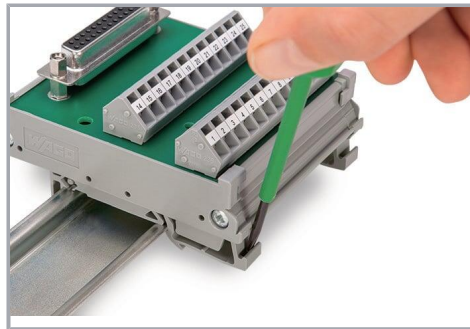

Removing a module from the DIN-rail.

Subject to changes. Please also observe the further product documentation!