

Sensor/actuator cable - SAC-3P-M12MS-M12FS SH/.../... - 1536049

Please be informed that the data shown in this PDF Document is generated from our Online Catalog. Please find the complete data in the user's documentation. Our General Terms of Use for Downloads are valid (<http://phoenixcontact.com/download>)



Sensor/actuator cable, 3-position, Variable cable type, shielded, Plug straight M12, A-coded, on Socket straight M12, A-coded, cable length: Free input (0.2 ... 40.0 m)

Your advantages

- ✓ Easy and safe: 100% electrically tested plug-in components
- ✓ Flexible solutions - configurable materials with variable cable types and cable lengths
- ✓ Reliable signal transmission – 360° shielding in environments with electromagnetic interference

Key Commercial Data

Packing unit	1 pc
Minimum order quantity	25 pc

Technical data

Dimensions

Length of cable	Free input (0.2 ... 40.0 m)
-----------------	-----------------------------

Ambient conditions

Ambient temperature (operation)	-25 °C ... 90 °C (Plug / socket)
Degree of protection	IP65/IP67/IP69K

General

Rated current at 40°C	4 A
Rated voltage	48 V AC
	60 V DC
Number of positions	3
Insulation resistance	≥ 100 MΩ
Coding	A - standard
Standards/regulations	M12 connector IEC 61076-2-101
Status display	No
Protective circuit/component	unwired
Overvoltage category	II
Degree of pollution	3
Test voltage	2500 V
Insertion/withdrawal cycles	≥ 100
Torque	0.4 Nm (M12 connector)

Sensor/actuator cable - SAC-3P-M12MS-M12FS SH/.../... - 1536049

Technical data

Material

Flammability rating according to UL 94	HB
Contact material	CuSn
Contact surface material	Ni/Au
Contact carrier material	TPU GF
Material of grip body	TPU, hardly inflammable, self-extinguishing
Material, knurls	Zinc die-cast, nickel-plated
Sealing material	NBR

Line characteristics

Note	This item is a sensor/actuator cable with a freely selectable cable type. The technical data for all possible cable types is listed in the table below.
------	---

Standards and Regulations

Standard designation	M12 connector
Standards/regulations	IEC 61076-2-101
Flammability rating according to UL 94	HB

PUR/PVC shielded, gray [100]

Cable type	PUR/PVC shielded, gray
Cable type (abbreviation)	100
Cable abbreviation	LiYV1CY11Y
Conductor cross section	0.34 mm ²
AWG signal line	22
Conductor structure signal line	42x 0.10 mm
Core diameter including insulation	1.5 mm ±0.05 mm
Thickness, insulation	≥ 0.23 mm (Core insulation)
	≥ 0.38 mm (Outer cable sheath)
	approx. 0.3 mm (Inner sheath)
Wire colors	brown, blue, black
Overall twist	3 wires, twisted
Shielding	Braided copper wires
Optical shield covering	85 %
External sheath, color	gray RAL 7001
External cable diameter D	5.2 mm ±0.2 mm
Smallest bending radius, fixed installation	52 mm
Smallest bending radius, movable installation	52 mm
Number of bending cycles	2000000
Bending radius	52 mm
Traversing path	5 m
Traversing rate	3 m/s
Cable weight	38 kg/km
Outer sheath, material	PUR
Material, inner sheath	PVC

Sensor/actuator cable - SAC-3P-M12MS-M12FS SH/.../... - 1536049

Technical data

PUR/PVC shielded, gray [100]

Material conductor insulation	PVC
Conductor material	Bare Cu litz wires
Insulation resistance	≥ 100 MΩ*km (at 20 °C)
Conductor resistance	max. 58 Ω/km (at 20 °C)
Nominal voltage, cable	≤ 300 V
Test voltage, cable	≥ 3000 V
Test voltage Core/Shield	≥ 2000 V
Ambient temperature (operation)	-25 °C ... 80 °C (cable, fixed installation)
	-5 °C ... 80 °C (cable, flexible installation)

PVC gray [500]

Cable type	PVC gray
Cable type (abbreviation)	500
Conductor cross section	0.34 mm ²
AWG signal line	22
Conductor structure signal line	42x 0.10 mm
Core diameter including insulation	1.4 mm ±0.02 mm
Thickness, insulation	≥ 0.23 mm (Core insulation)
	≥ 0.76 mm (Outer cable sheath)
Wire colors	brown, blue, black
Overall twist	3 wires, twisted
Shielding	Tinned copper braided shield
Optical shield covering	85 %
External sheath, color	gray RAL 7001
External cable diameter D	5.2 mm ±0.2 mm
Cable weight	40 kg/km
Outer sheath, material	PVC
Material conductor insulation	PVC
Conductor material	Bare Cu litz wires
Insulation resistance	≥ 1 GΩ*km (at 20 °C)
Conductor resistance	max. 58 Ω/km (at 20 °C)
Nominal voltage, cable	≤ 300 V
Test voltage, cable	≥ 3000 V
Ambient temperature (operation)	-25 °C ... 80 °C (cable, fixed installation)
	-5 °C ... 80 °C (cable, flexible installation)

PUR halogen-free black [PUR]

Cable type	PUR halogen-free black
Cable type (abbreviation)	PUR
Cable abbreviation	Li9Y-VI-C-VI-11Y
UL AWM style	20549
Conductor cross section	3x 0.34 mm ² (Signal line)

Sensor/actuator cable - SAC-3P-M12MS-M12FS SH/.../... - 1536049

Technical data

PUR halogen-free black [PUR]

AWG signal line	22
Conductor structure signal line	42x 0.10 mm
Core diameter including insulation	1.27 mm ±0.02 mm (Signal line)
Thickness, insulation	≥ 0.21 mm (Core insulation)
	approx. 0.5 mm (Outer cable sheath)
Wire colors	brown, blue, black
Overall twist	3 wires, twisted
Shielding	Braided copper wires
Optical shield covering	80 %
External sheath, color	black-gray RAL 7021
External cable diameter D	4.65 mm ±0.15 mm
Smallest bending radius, fixed installation	23 mm
Smallest bending radius, movable installation	47 mm
Number of bending cycles	10000000
Bending radius	47 mm
Traversing path	10 m
Traversing rate	3 m/s
Acceleration	10 m/s ²
Cable weight	31 kg/km
Outer sheath, material	PUR
Material conductor insulation	PP
Conductor material	Bare Cu litz wires
Insulation resistance	≥ 100 GΩ*km (at 20 °C)
Conductor resistance	max. 58 Ω/km (at 20 °C)
Nominal voltage, cable	≤ 300 V
Test voltage, cable	≥ 3000 V
Special properties	Flexible cable conduit capable
	Silicone-free
	Free of substances which would hinder coating with paint or varnish
Flame resistance	in accordance with UL 758/1581 FT2
	DIN EN 60332-2-2 (20 s)
Halogen-free	in accordance with DIN VDE 0472 part 815
Resistance to oil	in accordance with DIN EN 60811-2-1
Other resistance	Highly resistant to acids, alkaline solutions and solvents
	hydrolysis and microbe resistant
	partly UV-resistant in accordance with DIN EN ISO 4892-2-A
Ambient temperature (operation)	-40 °C ... 80 °C (cable, fixed installation)
	-25 °C ... 80 °C (cable, flexible installation)

PVC shielded black [PVC]

Cable type	PVC shielded black
------------	--------------------

Sensor/actuator cable - SAC-3P-M12MS-M12FS SH/.../... - 1536049

Technical data

PVC shielded black [PVC]

Cable type (abbreviation)	PVC
Conductor cross section	3x 0.34 mm ²
AWG signal line	22
Conductor structure signal line	42x 0.10 mm
Core diameter including insulation	1.4 mm ±0.02 mm
Thickness, insulation	≥ 0.23 mm (Core insulation)
	≥ 0.76 mm (Outer cable sheath)
Wire colors	brown, blue, black
Overall twist	3 wires, twisted
Shielding	Tinned copper braided shield
Optical shield covering	85 %
External sheath, color	black RAL 9005
External cable diameter D	5.2 mm ±0.2 mm
Cable weight	40 kg/km
Outer sheath, material	PVC
Material conductor insulation	PVC
Conductor material	Bare Cu litz wires
Insulation resistance	≥ 100 MΩ*km (at 20 °C)
Conductor resistance	max. 58 Ω/km (at 20 °C)
Nominal voltage, cable	≤ 300 V
Test voltage, cable	≥ 3000 V
Flame resistance	As per UL-Style 2464
Ambient temperature (operation)	-25 °C ... 80 °C (cable, fixed installation)
	-5 °C ... 80 °C (cable, flexible installation)

Environmental Product Compliance

China RoHS	Environmentally Friendly Use Period = 50
	For details about hazardous substances go to tab "Downloads", Category "Manufacturer's declaration"

Drawings

Sensor/actuator cable - SAC-3P-M12MS-M12FS SH/.../... - 1536049

Dimensional drawing

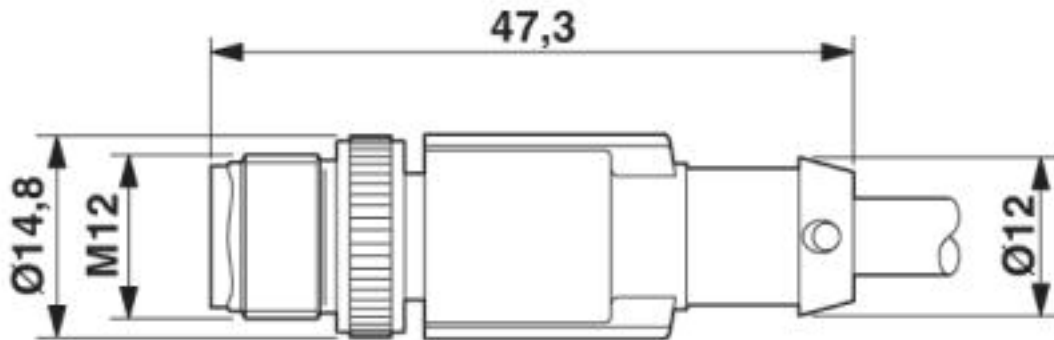

Plug, M12 x 1, straight, shielded

Dimensional drawing

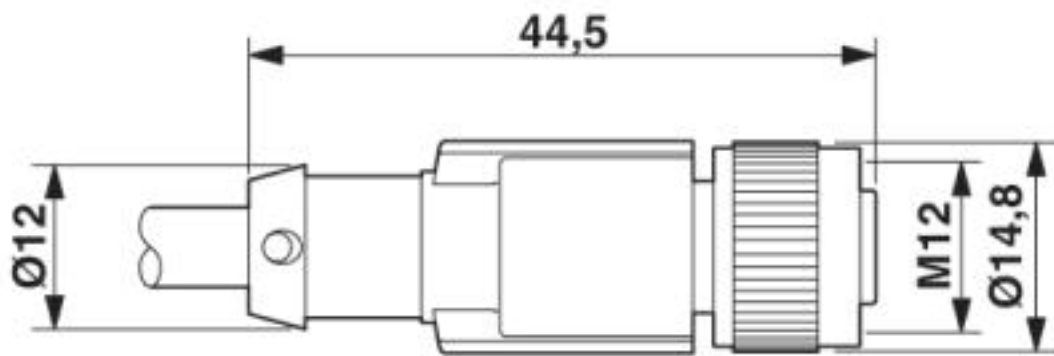

M12 x 1 socket, straight, shielded

Circuit diagram

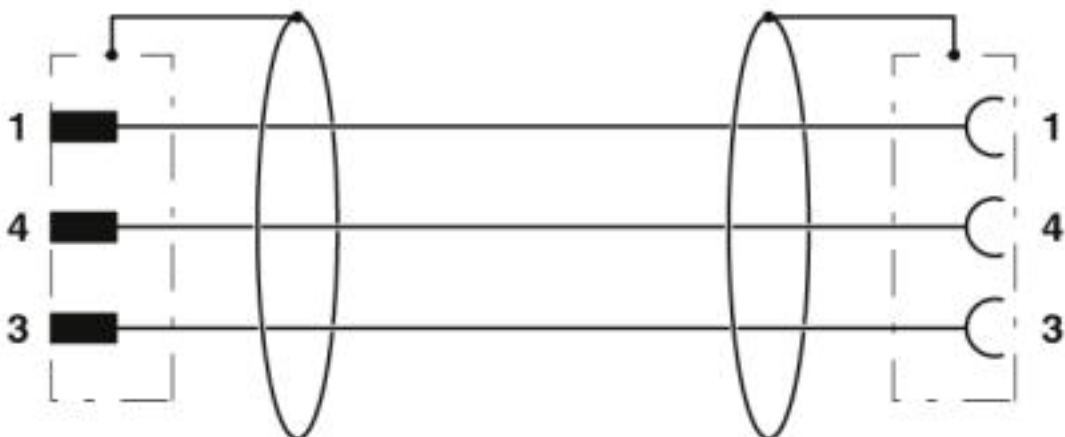

Contact assignment of M8 plugs / M12 sockets

Sensor/actuator cable - SAC-3P-M12MS-M12FS SH/.../... - 1536049

Schematic diagram

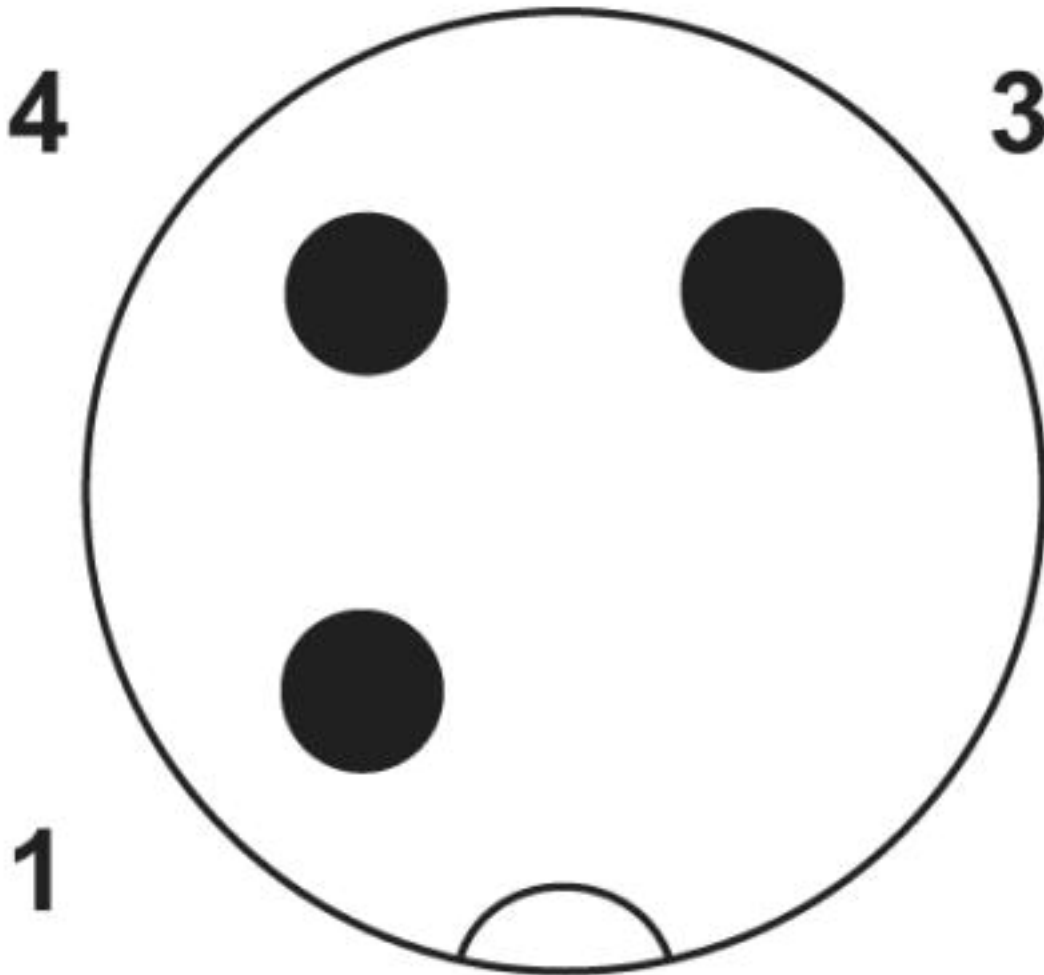

Pin assignment M12 plug, 3-pos., A-coded, view male side

Sensor/actuator cable - SAC-3P-M12MS-M12FS SH/.../... - 1536049

Schematic diagram

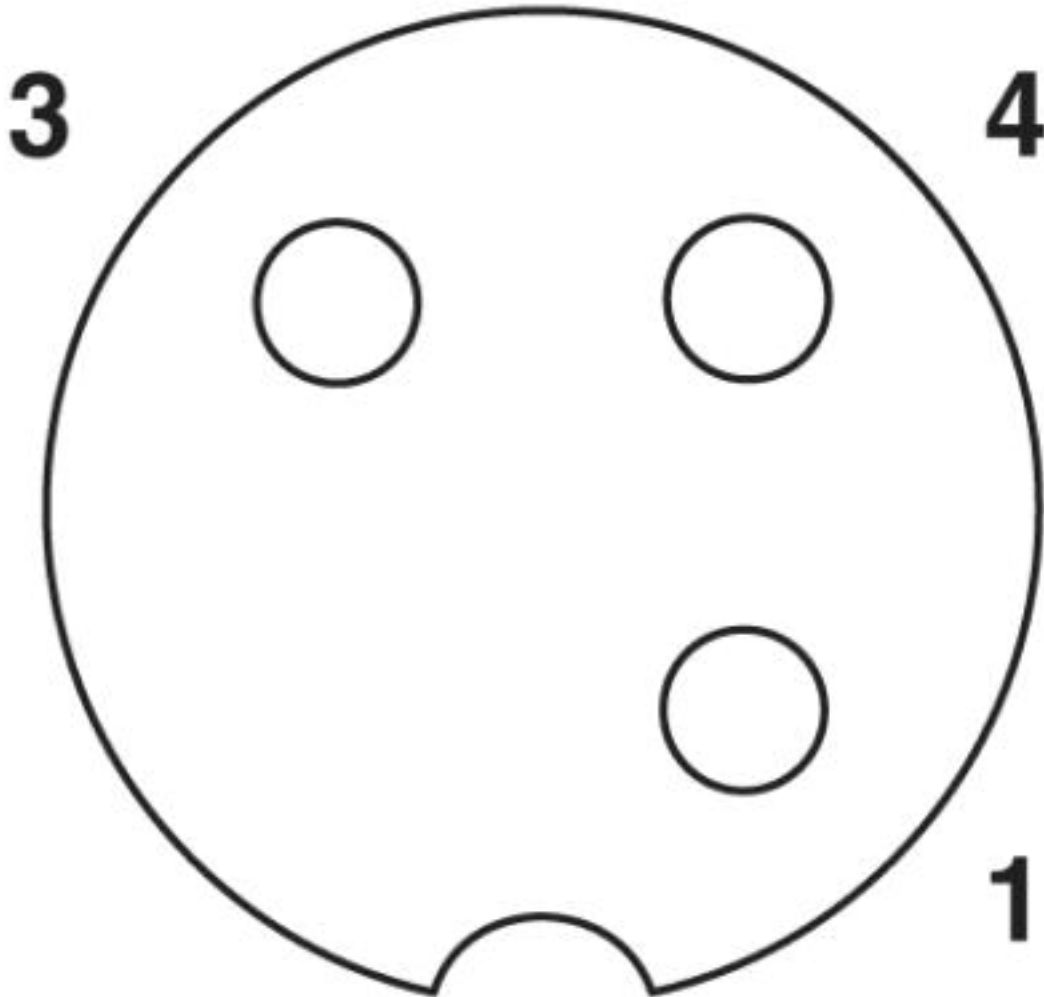

Pin assignment M12 socket, 3-pos., A-coded, view female side

Sensor/actuator cable - SAC-3P-M12MS-M12FS SH/.../... - 1536049

Cable cross section

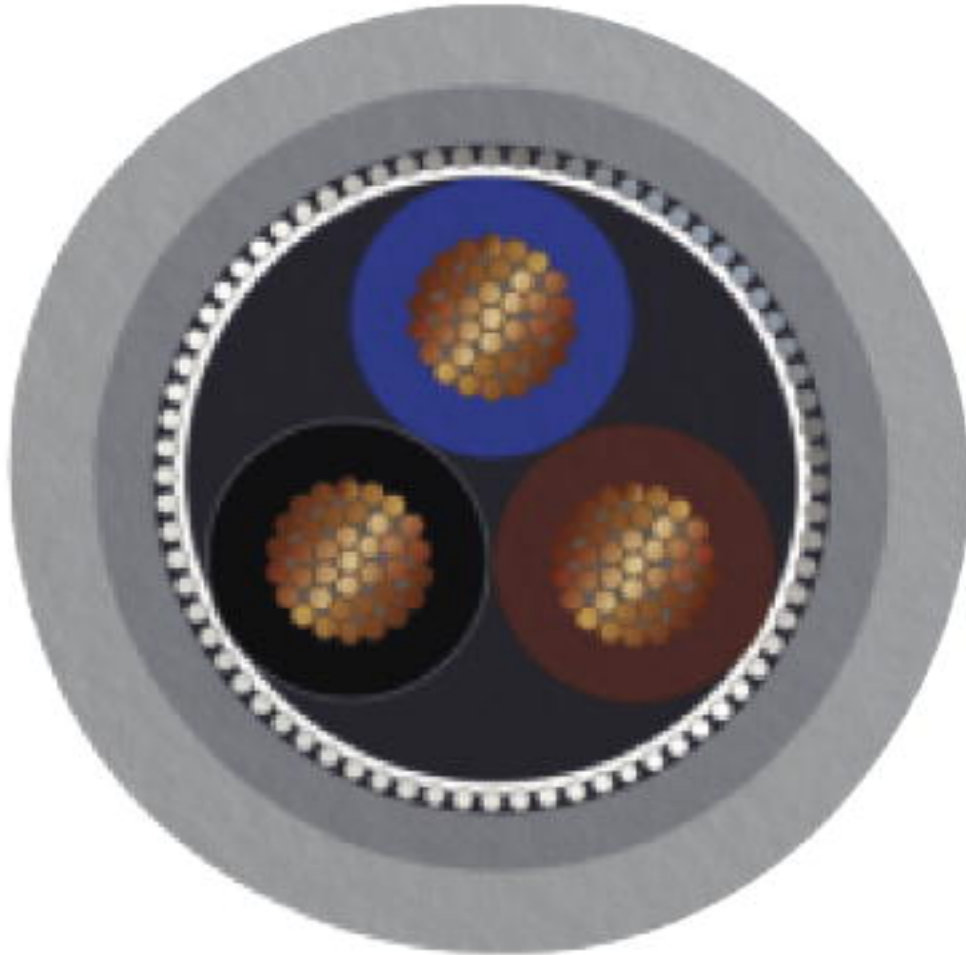

PUR/PVC shielded, gray [100]

Sensor/actuator cable - SAC-3P-M12MS-M12FS SH/.../... - 1536049

Cable cross section

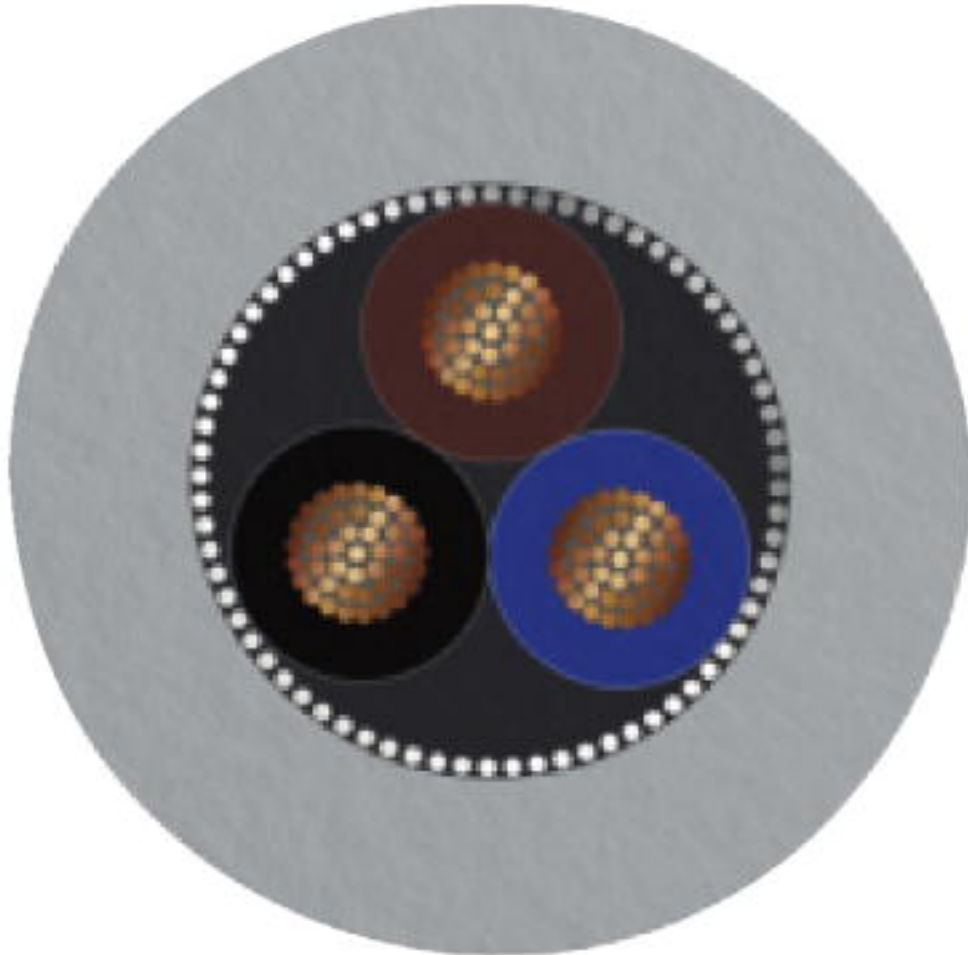

PVC gray [500]

Sensor/actuator cable - SAC-3P-M12MS-M12FS SH/.../... - 1536049

Cable cross section

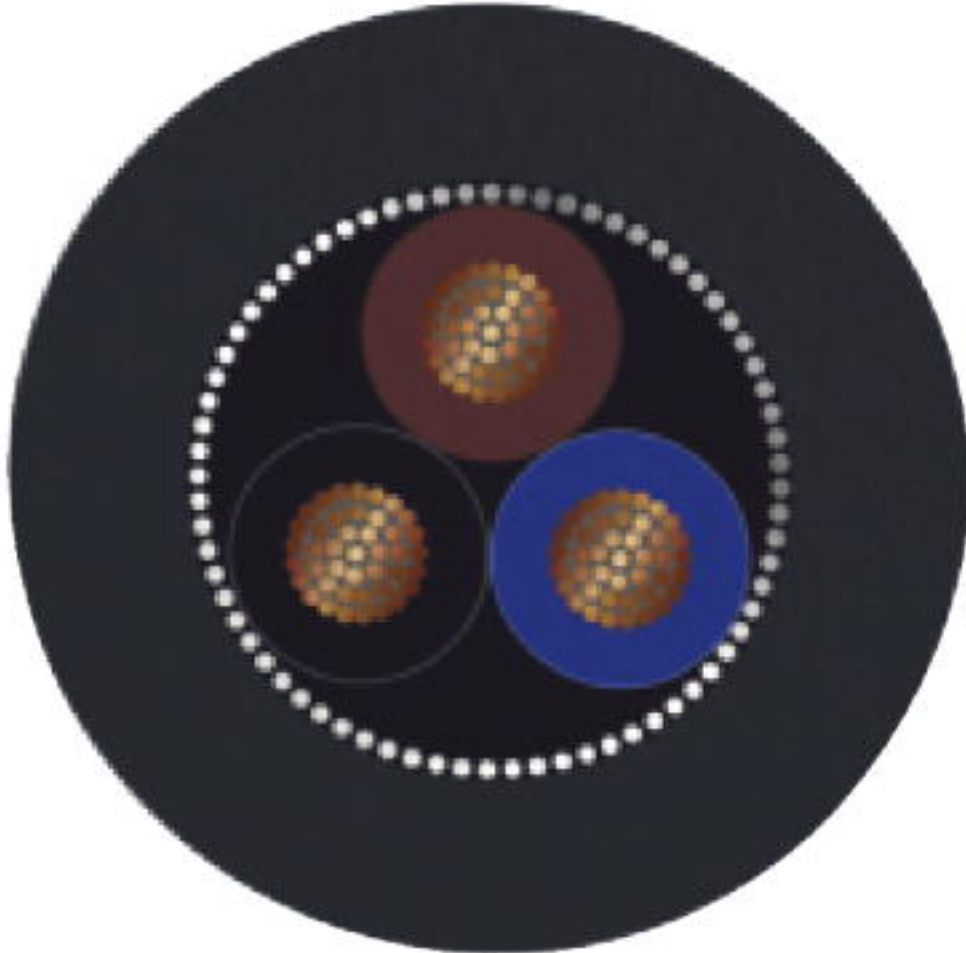

PVC shielded black [PVC]

Approvals

Approvals

Approvals

UL Listed / cUL Listed / EAC / cULus Listed

Ex Approvals

Approval details

Sensor/actuator cable - SAC-3P-M12MS-M12FS SH/.../... - 1536049

Approvals

UL Listed		http://database.ul.com/cgi-bin/XYV/template/LISEXT/1FRAME/index.htm	FILE E 221474
Nominal voltage UN		300 V	
Nominal current IN		4 A	

cUL Listed		http://database.ul.com/cgi-bin/XYV/template/LISEXT/1FRAME/index.htm	FILE E 221474
Nominal voltage UN		300 V	
Nominal current IN		4 A	

EAC		RU C- DE.BL08.B.00286
-----	--	--------------------------

cULus Listed	
--------------	--

Phoenix Contact 2019 © - all rights reserved
<http://www.phoenixcontact.com>

PHOENIX CONTACT GmbH & Co. KG
Flachsmarktstr. 8
32825 Blomberg
Germany
Tel. +49 5235 300
Fax +49 5235 3 41200
<http://www.phoenixcontact.com>