

100-120 VAC



200-240 VAC



SLB™ Branch Office Manager User Guide

Intellectual Property

© 2019 Lantronix, Inc. All rights reserved. No part of the contents of this publication may be transmitted or reproduced in any form or by any means without the written permission of Lantronix. Printed in the United States of America.

Lantronix is a registered trademark of Lantronix, Inc. in the U.S. and certain other countries. *Lantronix Spider* is a registered trademark, and *SLB*, *SLC*, *SLP*, *vSLM*, *Spider* and *DeviceInstaller* are trademarks of Lantronix, Inc.

Patented: <http://patents.lantronix.com>; additional patents pending.

Windows and *Internet Explorer* are registered trademarks of Microsoft Corporation. *Mozilla* and *Firefox* are registered trademarks of the Mozilla Foundation. *Chrome* is a trademark of Google, Inc. All other trademarks and trade names are the property of their respective holders.

Open Source Software

Some applications are Open Source software licensed under the Berkeley Software Distribution (BSD) license or the GNU General Public License (GPL) as published by the Free Software Foundation (FSF). Lantronix grants you no right to receive source code to the Open Source software; however, in some cases, rights and access to source code for certain Open Source software may be available directly from Lantronix' licensors. Upon request, Lantronix will identify the Open Source components and the licenses that apply to them. Your use of each Open Source component or software is subject to the terms of the applicable license. The GNU General Public License is available at <http://www.gnu.org/licenses/gpl.html>.

Open Source Software is distributed WITHOUT ANY WARRANTY, INCLUDING ANY IMPLIED WARRANTY OF MERCHANTABILITY OR FITNESS FOR A PARTICULAR PURPOSE. See the GPL and BSD for details.

Warranty

For details on the Lantronix warranty policy, please go to our Web site at www.lantronix.com/support/warranty.

Contacts

Lantronix, Inc.

7535 Irvine Center Drive
Suite 100
Irvine, CA 92618, USA
Phone: 949-453-3990
Fax: 949-453-3995

Technical Support

Online: www.lantronix.com/support

Sales Offices

For a current list of our domestic and international sales offices, go to the Lantronix web site at www.lantronix.com/about/contact.

Disclaimer & Revisions

All information contained herein is provided “AS IS.” **Lantronix undertakes no obligation to update the information in this publication.** Lantronix does not make, and specifically disclaims, all warranties of any kind (express, implied or otherwise) regarding title, non-infringement, fitness, quality, accuracy, completeness, usefulness, suitability or performance of the information provided herein. Lantronix shall have no liability whatsoever to any user for any damages, losses and causes of action (whether in contract or in tort or otherwise) in connection with the user’s access or usage of any of the information or content contained herein. **The information and specifications contained in this document are subject to change without notice.**

Operation of this equipment in a residential area is likely to cause interference, in which case the user, at his or her own expense, will be required to take whatever measures may be required to correct the interference.

Note: *This equipment has been tested and found to comply with the limits for Class A digital device pursuant to Part 15 of the FCC Rules. These limits are designed to provide reasonable protection against harmful interference when the equipment is operated in a commercial environment. This equipment generates, uses, and can radiate radio frequency energy and, if not installed and used in accordance with this user guide, may cause interference to radio communications. Operation of this equipment in a residential area is likely to cause interference, in which case the user will be required to correct the interference at his own expense.*

The user is cautioned that changes and modifications made to the equipment without approval of the manufacturer could void the user’s authority to operate this equipment.

Changes or modifications to this device not explicitly approved by Lantronix will void the user’s authority to operate this device.

Revision History

Date	Rev.	Comments
April 2013	A	Initial Release (6.0).
June 2014	B	Added the new 200-240 VAC SLB model.
August 2014	C	Updated for firmware release 6.1.
January 2015	D	Updated technical specification information.
May 2016	E	Updated safety information.
December 2016	F	Updated to firmware revision 6.3.0.0, which includes: <ul style="list-style-type: none">◆ Removal of java from the WebSSH and WebTelnet application◆ Addition of transport security layer (TLS) 1.1 and 1.2◆ Upgrade of web SSL certificate to 2048 bits◆ Option to disable SSH DSA keys◆ Zero touch provisioning◆ Custom SSL certificate for the web◆ Compliance information updates
June 2018	G	Updated to firmware revision 6.5.0.0RC19.
October 2018	H	Updated to firmware revision 6.6, which includes: <ul style="list-style-type: none">◆ Sierra gateway LTE modem integration

March 2019	J	Updated to firmware revision 6.7.0.0RC12, which includes: <ul style="list-style-type: none">◆ Support for custom Expect scripts that can be connected to the SLB CLI or a device port◆ Web and SSH support for SHA2 and higher◆ ConsoleFlow access timeout settings
April 2019	K	Updated to firmware revision 6.8.0.0RC8, which includes support for Tcl and Python custom scripts.

Table of Contents

Intellectual Property	2
Open Source Software	2
Warranty	2
Contacts	2
Disclaimer & Revisions	3
Revision History	3
List of Figures	14
List of Tables	17

1: About this Guide 18

Purpose and Audience	18
Summary of Chapters	18
Additional Documentation	19

2: Introduction 20

Features	20
Console Management	20
Power Management Outlets for Power Connectivity	20
Power Inlets	20
Integration with Other Secure Lantronix Products	20
Internal Temperature Sensor	21
Designed for Branch Offices and Similar Environments	21
Typical Equipment	22
Types of Business	22
Benefits	22
Models	23
System Features	24
Protocols Supported	24
Access Control	25
Power Outlet Control	25
Device Port Buffer	25
Configuration Options	25
Application Example	26
Hardware Features	27
Serial Connections	28
Network Connections	29
USB Interface	29
Modem Interface	30

3: Installation	31
What's in the Box	31
Product Information Label	32
Technical Specifications	32
Safety Precautions	33
Cover	33
Power Plug	33
Input Supply	34
Grounding	34
Fuses	34
Rack	34
Port Connections	35
Physical Installation	35
Connecting to a Device Port	36
Connecting to Network Ports	36
Connecting Terminals	37
Connecting to the Internal Modem	37
Power	37
AC Input	37
Connecting Devices to Power Outlets	38
Typical Installations	39
4: Quick Setup	41
Recommendations	41
IP Address	41
Method #1 Using the Front Panel Display	42
Front Panel LCD Display and Keypads	42
Navigating	43
Entering the Settings	44
Restoring Factory Defaults	45
Limiting Sysadmin User Access	45
Method #2 Quick Setup on the Web Page	46
Network Settings	48
Date & Time Settings	48
Administrator Settings	48
Method #3 Quick Setup on the Command Line Interface	49
Next Step	51
5: Web and Command Line Interfaces	52
Web Interface	52
Logging in	53
Logging Out	54

Web Page Help _____	54
Command Line Interface _____	54
Logging In _____	54
Logging Out _____	55
Command Syntax _____	55
Command Line Help _____	56
Tips _____	56
General CLI Commands _____	57

6: Basic Parameters 58

Requirements _____	58
Eth1 and Eth2 Settings _____	60
Hostname & Name Servers _____	61
DNS Servers _____	61
DHCP-Acquired DNS Servers _____	62
GPRS-Acquired DNS Servers _____	62
TCP Keepalive Parameters _____	62
Gateway _____	62
Fail-Over Settings _____	62
Fail-Over Cellular Gateway Configuration _____	63
Advanced Cellular Gateway Configuration _____	64
Fail-Over Cellular Gateway Firmware _____	64
Load Cellular Gateway Firmware Options _____	64
Ethernet Counters _____	64
Network Commands _____	64
IP Filter _____	65
Viewing IP Filters _____	65
Enabling IP Filters _____	65
Configuring IP Filters _____	66
Rule Parameters _____	67
Updating an IP Filter _____	69
Deleting an IP Filter _____	69
Mapping a Ruleset _____	69
IP Filter Commands _____	69
Routing _____	69
Dynamic Routing _____	70
Static Routing _____	70
Routing Commands _____	70
VPN _____	71
Performance Monitoring _____	74
Performance Monitoring - Add/Edit Probe _____	77
Performance Monitoring - Results _____	79
Performance Monitoring Commands _____	83

7: Services 84

System Logging and Other Services	84
SSH/Telnet/Logging	85
System Logging	85
Audit Log	86
SMTP	86
SSH	86
Telnet	87
Web SSH/Web Telnet Settings	87
Phone Home	87
SNMP	88
Communities	89
Version 3	90
V3 Read-Only User	90
V3 Read-Write User	90
SNMP, SSH, Telnet, and Logging Commands	90
NFS and SMB/CIFS	91
SMB/CIFS Share	92
NFS and SMB/CIFS Commands	92
Secure Lantronix Network	92
Troubleshooting Browser Issues	96
Web SSH/Telnet Copy and Paste	98
Secure Lantronix Network Commands	98
Date and Time	99
Date and Time Commands	100
Web Server	100
Administrative Commands	102
Services - Web Sessions	102
Services - SSL Certificate	103
SSL Certificate Commands	105
ConsoleFlow	106
ConsoleFlow Commands	109

8: Device Ports 110

Connection Methods	110
Permissions	110
Device Status	111
Global Port Settings	111
Telnet/SSH/TCP in Port Numbers	112
Global Commands	113
Device Ports - Settings	113
Device Port Settings	115

IP Settings	115
Data Settings	116
Hardware Signal Triggers	117
Modem Settings	117
Modem Settings: Text Mode	118
Modem Settings: PPP Mode	118
Port Status and Counters	120
Device Ports - SLP Units	120
Status/Info	121
Commands	122
Device Port - Sensorsoft Device	122
Device Port Commands	123
Interacting with a Device Port	123
Device Ports - Logging	124
Local Logging	124
NFS File Logging	124
USB Flash Drive Logging	124
Email/SNMP Notification	125
Sylogs Logging	125
Local Logging	126
Email/SNMP Traps	126
Log Viewing Attributes	127
NFS File Logging	128
USB Logging	128
Syslog Logging	128
Logging Commands	128
Console Port	128
Console Port Commands	130
Power Outlets	130
Power Commands	132
Host Lists	132
Host List Commands	134
Scripts	134
Scripts	136
User Rights	137
Batch Script Syntax	142
Interface Script Syntax	142
Custom Script Syntax	147
Example Scripts	149
Sites	165
Site Commands	167
Modem Dialing States	167
Dial-In	167

Dial-Out	168
Dial-Back	168
Dial-On-Demand	169
Dial-In & Dial-On-Demand	169
Dial-Back & Dial-On-Demand	169
Dial-In/Host List	170
CBCP Server and CBCP Client	170
CBCP Server	170
CBCP Client	171

9: USB Port **172**

Set Up of USB Storage	172
Data Settings	175
GSM/GPRS Settings	175
Modem Settings	175
Text Mode	177
PPP Mode	177
IP Settings	178
Manage Firmware and Configuration Files	179
USB Commands	179

10: Connections **180**

Typical Setup Scenarios for the SLB	180
Terminal Server	180
Remote Access Server	181
Reverse Terminal Server	181
Multiport Device Server	182
Console Server	182
Connection Configuration	183
Connection Commands	185

11: User Authentication **186**

Authentication Commands	188
Local and Remote User Settings	189
Adding, Editing or Deleting a User	191
Shortcut	194
Local Users Commands	194
NIS	194
NIS Commands	197
LDAP	197
LDAP Commands	201
RADIUS	202

RADIUS Commands _____	205
User Attributes & Permissions from LDAP Schema or RADIUS VSA _____	205
Kerberos _____	207
Kerberos Commands _____	209
TACACS+ _____	210
TACACS+ Groups _____	210
TACACS+ Commands _____	213
Groups _____	214
SSH Keys _____	217
Imported Keys _____	217
Exported Keys _____	217
Imported Keys (SSH In) _____	219
Host & Login for Import _____	219
Exported Keys (SSH Out) _____	219
Host and Login for Export _____	220
SSH Key Commands _____	222
Custom Menus _____	223
Custom User Menu Commands _____	225

12: Maintenance 226

SLB Maintenance _____	226
Internal Temperature _____	228
Site Information _____	228
SLB Firmware _____	228
Boot Banks _____	229
Load Firmware Via Options _____	229
Configuration Management _____	230
Zero Touch Provisioning Configuration Restore _____	231
Administrative Commands _____	232
System Logs _____	232
System Log Commands _____	234
Audit Log _____	234
Email Log _____	235
Diagnostics _____	236
Diagnostic Commands _____	238
Status/Reports _____	238
View Report _____	239
Status Commands _____	241
Emailing Logs and Reports _____	241
Events _____	242
Events Commands _____	244
LCD/Keypad _____	244
LCD/Keypad Commands _____	246

Banners _____	246
Banner Commands _____	247
13: Application Examples	248
Telnet/SSH to a Remote Device _____	248
Dial-in (Text Mode) to a Remote Device _____	250
Local Serial Connection to Network Device via Telnet _____	251
14: Command Reference	253
Introduction to Commands _____	253
Command Syntax _____	253
Command Line Help _____	254
Tips _____	254
Administrative Commands _____	255
Audit Log Commands _____	266
Authentication Commands _____	267
ConsoleFlow Commands _____	268
Kerberos Commands _____	269
LDAP Commands _____	270
Local Users Commands _____	271
NIS Commands _____	275
RADIUS Commands _____	276
TACACS+ Commands _____	277
User Permissions Commands _____	278
CLI Commands _____	281
Connection Commands _____	283
Console Port Commands _____	286
Custom User Menu Commands _____	287
Date and Time Commands _____	289
Device Commands _____	290
Device Port Commands _____	291
Diagnostic Commands _____	295
Top Command Synopsis _____	297
End Device Commands _____	298
Events Commands _____	299
Global Commands _____	300
Group Commands _____	301
Host List Commands _____	302
IP Filter Commands _____	303
Logging Commands _____	304
Network Commands _____	307
NFS and SMB/CIFS Commands _____	310
Performance Monitoring Commands _____	312

Power Commands _____	316
Routing Commands _____	318
Script Commands _____	318
Services Commands _____	321
Site Commands _____	323
Secure Lantronix Network Commands _____	324
SSH Key Commands _____	325
Status Commands _____	328
System Log Commands _____	329
USB Storage Commands _____	330
USB Modem Commands _____	331
Appendix A: Bootloader	335
Accessing the Bootloader _____	335
Bootload Commands _____	335
Appendix B: Security Considerations	337
Security Practice _____	337
Factors Affecting Security _____	337
Appendix C: Adapters and Pinouts	338
Appendix D: Protocol Glossary	341
Appendix E: Compliance Information	343

List of Figures

Figure 2-1 Branch to Enterprise Integration Concept	21
Figure 2-3 100-120 VAC SLB Unit	23
Figure 2-4 200-240 VAC SLB Unit	24
Figure 2-5 Example Deployment	27
Figure 2-6 Device Port Connections	29
Figure 2-7 Console Port Connection	29
Figure 2-8 Network Connection	29
Figure 2-9 USB Interface	29
Figure 2-10 Modem Interface	30
Figure 3-5 Inlet Pin Assignment	34
Figure 3-6 CAT 5 Cable Connection	36
Figure 3-7 AC Power Input	38
Figure 3-8 100-120 VAC SLB - Branch Office Manager Power Outlets	38
Figure 3-9 200-240 VAC SLB - Branch Office Manager Power Outlets	39
Figure 3-10 100-120 VAC SLB Installation Diagram	39
Figure 3-11 200-240 VAC SLB Installation Diagram	40
Figure 4-2 Front Panel LCD Display and Five Button Keypads (Enter, Up, Down, Left, Right)	42
Figure 4-5 Quick Setup	47
Figure 4-6 Beginning of Quick Setup Script	49
Figure 4-7 Completed Quick Setup	50
Figure 5-1 Web Page Layout	52
Figure 6-1 Network > Network Settings (top of page)	59
Figure 6-2 Network > Network Settings (bottom of page)	60
Figure 6-3 Network > IP Filter	65
Figure 6-4 Network > IP Filter Ruleset (Adding/Editing Rulesets)	67
Figure 6-5 Network > Routing	70
Figure 6-6 Network > VPN	71
Figure 6-7 Network > Perf Monitoring	75
Figure 6-8 Performance Monitoring - Add/Edit Probe	77
Figure 6-10 Performance Monitoring - Operations	82
Figure 7-1 Services > SSH/Telnet/Logging	85
Figure 7-2 Services > SNMP	88
Figure 7-3 Services > NFS/CIFS	91
Figure 7-4 Services > Secure Lantronix Network	93
Figure 7-5 IP Address Login Page	94
Figure 7-6 SSH or Telnet CLI Session	94

Figure 7-7 Disabled Port Number Popup Window _____	95
Figure 7-8 Services > Secure Lantronix Network > Search Options _____	96
Figure 7-9 Services > Date & Time _____	99
Figure 7-10 Services > Web Server _____	101
Figure 7-11 Web Sessions _____	103
Figure 7-12 SSL Certificate _____	104
Figure 7-13 Services > ConsoleFlow _____	107
Figure 8-1 Devices > Device Status _____	111
Figure 8-2 Devices > Device Ports _____	112
Figure 8-3 Device Ports List _____	113
Figure 8-4 Device Ports > Settings _____	114
Figure 8-6 Device Ports > SLP _____	121
Figure 8-7 Devices > Device Ports > Sensorsoft _____	122
Figure 8-8 Devices > Device Ports - Logging _____	126
Figure 8-9 Devices > Console Port _____	129
Figure 8-10 Devices > Power Outlets _____	131
Figure 8-11 Devices > Host Lists _____	133
Figure 8-12 Devices > Scripts _____	135
Figure 8-13 Adding or Editing New Scripts _____	136
Figure 8-14 Devices > Scripts - Scheduler _____	138
Figure 8-15 Custom Scripts - Operations _____	140
Figure 8-16 View Custom Script Results _____	141
Figure 8-21 Devices > Sites _____	165
Figure 9-1 Devices > USB _____	172
Figure 9-2 Devices > USB > Configure _____	173
Figure 9-3 Devices > USB > Modem _____	174
Figure 9-4 Firmware and Configurations - Manage Files (Top of Page) _____	179
Figure 10-1 Terminal Server _____	181
Figure 10-2 Remote Access Server _____	181
Figure 10-3 Reverse Terminal Server _____	181
Figure 10-4 Multiport Device Server _____	182
Figure 10-5 Devices > Connections _____	183
Figure 10-6 Current Connections _____	184
Figure 11-1 User Authentication > Authentication Methods _____	187
Figure 11-2 User Authentication > Local/Remote Users _____	189
Figure 11-3 User Authentication > Local/Remote User > Settings _____	191
Figure 11-4 User Authentication > NIS _____	195
Figure 11-5 User Authentication > LDAP _____	198

Figure 11-6 User Authentication > RADIUS	202
Figure 11-7 User Authentication > Kerberos	207
Figure 11-8 User Authentication > TACACS+	211
Figure 11-9 User Authentication > Group	215
Figure 11-10 User Authentication > SSH Keys	218
Figure 11-11 Current Host Keys	221
Figure 11-12 User Authentication > Custom Menus	223
Figure 12-1 Maintenance > Firmware & Configurations	227
Figure 12-2 Manage Configuration Files	231
Figure 12-3 Maintenance > System Logs	232
Figure 12-4 System Logs	234
Figure 12-5 Maintenance > Audit Log	235
Figure 12-6 Maintenance > Email Log	236
Figure 12-7 Maintenance > Diagnostics	237
Figure 12-8 Diagnostics Report	238
Figure 12-9 Maintenance > Status/Reports	239
Figure 12-10 Generated Status/Reports	240
Figure 12-11 Emailed Log or Report	242
Figure 12-12 Maintenance > Events	243
Figure 12-13 Maintenance > LCD/Keypad	245
Figure 12-14 Maintenance > Banners	246
Figure 13-1 SLB - Branch Office Manager Configuration	248
Figure 13-2 Remote User Connected to a SUN Server via the SLB	248
Figure 13-3 Dial-in (Text Mode) to a Remote Device	250
Figure 13-4 Local Serial Connection to Network Device via Telnet	251
Figure C-1 RJ45 Receptacle to DB25M DCE Adapter for the SLB (PN 200.2066A)	338
Figure C-2 RJ45 Receptacle to DB25F DCE Adapter for the SLB (PN 200.2067A)	339
Figure C-3 RJ45 Receptacle to DB9M DCE Adapter for the SLB (PN 200.2069A)	339
Figure C-4 RJ45 Receptacle to DB9F DCE Adapter for the SLB (PN 200.2070A)	340
Figure C-5 RJ45 to RJ45 Adapter for Netra/Sun/Cisco and SLP (PNs 200.2225 and ADP010104-01)	

340

List of Tables

Table 2-2 SLB Models _____	23
Table 3-1 Part Numbers and Descriptions for Adapters and Cables _____	31
Table 3-2 Part Numbers and Descriptions for Power Cords _____	31
Table 3-3 SLB Technical Specifications _____	32
Table 3-4 Max Current per Power Cord Used _____	33
Table 4-1 Methods of Assigning an IP Address _____	41
Table 4-3 LCD Arrow Keypad Actions _____	43
Table 4-4 Front Panel Setup Options with Associated Parameters _____	43
Table 5-2 Actions and Category Options _____	55
Table 6-9 Error Conditions _____	81
Table 8-5 Port Status and Counters _____	120
Table 8-17 Definitions _____	143
Table 8-18 Primary Commands _____	144
Table 8-19 Secondary Commands _____	145
Table 8-20 Control Flow Commands _____	146
Table 14-1 Actions and Category Options _____	253
Table A-1 User Commands _____	335
Table A-2 Administrator Commands _____	336

1: About this Guide

Purpose and Audience

This guide provides the information needed to install, configure, and use the Lantronix® SLB™ branch office manager. The SLB device is for IT professionals who must remotely and securely configure and administer servers, routers, switches, telephone equipment, or other devices equipped with a serial port for facilities that are typically remote branch offices or “distributed” IT locations.

Summary of Chapters

The remaining chapters in this guide include:

Chapter	Description
Chapter 2: Introduction	Describes the SLB models, their main features, and the protocols they support.
Chapter 3: Installation	Provides technical specifications; describes connection formats and power supplies; provides instructions for installing the SLB unit in a rack.
Chapter 4: Quick Setup	Provides instructions for getting your SLB device up and running and for configuring required settings.
Chapter 5: Web and Command Line Interfaces	Describes the web and command line interfaces available for configuring the SLB branch office manager. The configuration chapters (6-12) provide detailed instructions for using the web interface and include equivalent command line interface commands.
Chapter 6: Basic Parameters	Provides instructions for configuring network ports, firewall and routing settings, and the date and time.
Chapter 7: Services	Provides instructions for enabling and disabling system logging, SSH and Telnet logins, SNMP, SMTP, and the date and time.
Chapter 8: Device Ports	Provides instructions for configuring global device port settings, individual device port settings, and console port settings.
Chapter 9: USB Port	Provides instructions for using the USB port.
Chapter 10: Connections	Provides instructions for configuring connections and viewing, updating, or disconnecting a connection.
Chapter 11: User Authentication	Provides instructions for enabling or disabling methods that authenticate users who attempt to log in via SSH, Telnet, or the console port. Provides instructions for creating custom menus.
Chapter 12: Maintenance	Provides instructions for upgrading firmware, viewing system logs and diagnostics, generating reports, and defining events. Includes information about web pages and commands used to shut down and reboot the SLB unit.
Chapter 13: Application Examples	Shows how to set up and use the SLB branch office manager in three different configurations.
Chapter 14: Command Reference	Lists and describes all of the commands available on the SLB command line interface

Chapter (continued)	Description
Appendix A: Bootloader	Lists and describes the commands available for the bootloader command line interface.
Appendix B: Security Considerations	Provides tips for enhancing SLB security.
Appendix C: Adapters and Pinouts	Includes adapter pinout diagrams.
Appendix D: Protocol Glossary	Lists the protocols supported by the SLB unit with brief descriptions.
Appendix E: Compliance Information	Provides information about the SLB device's compliance with industry standards.

Additional Documentation

Visit the Lantronix Web site at www.lantronix.com/support/documentation for the latest documentation and the following additional documentation.

Document	Description
<i>SLB Branch Office Manager Quick Start</i>	Describes the steps for getting the SLB unit up and running.
<i>SLB Branch Office Manager Online Help for the Command Line Reference</i>	Provides online help for configuring the SLB device using commands.
<i>SLB Branch Office Manager Online Help for the Web Interface</i>	Provides online help for configuring the SLB unit using the web page.

2: Introduction

The SLB branch office manager enables IT system administrators to manage remote servers and IT infrastructure equipment securely over the Internet. This innovative hybrid device combines the capabilities of the award-winning secure console manager with an 8-port remote power management solution into a compact, 1U rack-mountable appliance.

Features

Console Management

- ◆ 8 serial ports for console connectivity
- ◆ Enables system administrators to remotely manage devices with serial console ports, e.g., Linux, Unix, and recent versions of Windows servers, routers, switches, telecom, and building access equipment.
- ◆ Provides data logging, monitoring, and secure access control via the Internet

Power Management Outlets for Power Connectivity

- ◆ 8 outlets for power connectivity
- ◆ Provides ability to control power individually to all attached equipment
- ◆ Provides on/off/reboot control
- ◆ Per port power consumption monitoring
- ◆ SLB882KIT-15P and SLB882KIT-20P outlets support NEMA 5-15P & 5-20P plugs
- ◆ SLB8824KIT-AP and SLB8824KIT-EU outlets support C14 plugs
- ◆ Ensures safe power distribution and reduces in-rush current overload

Power Inlets

- ◆ SLB882KIT-xx Dual 100-120 VAC power inlets
- ◆ SLB8824KIT-xx Dual 200-240 VAC power inlets
- ◆ Provides automatic power switch-over when both primary and secondary power inlet sources are used

Integration with Other Secure Lantronix Products

- ◆ Can integrate seamlessly with the ConsoleFlow™ or vSLM™ management appliance software for a complete end-to-end Out-of-Band (OOB) management solution.

Internal Temperature Sensor

- ◆ System administrators can be alerted if temperature goes out of range.

Figure 2-1 Branch to Enterprise Integration Concept

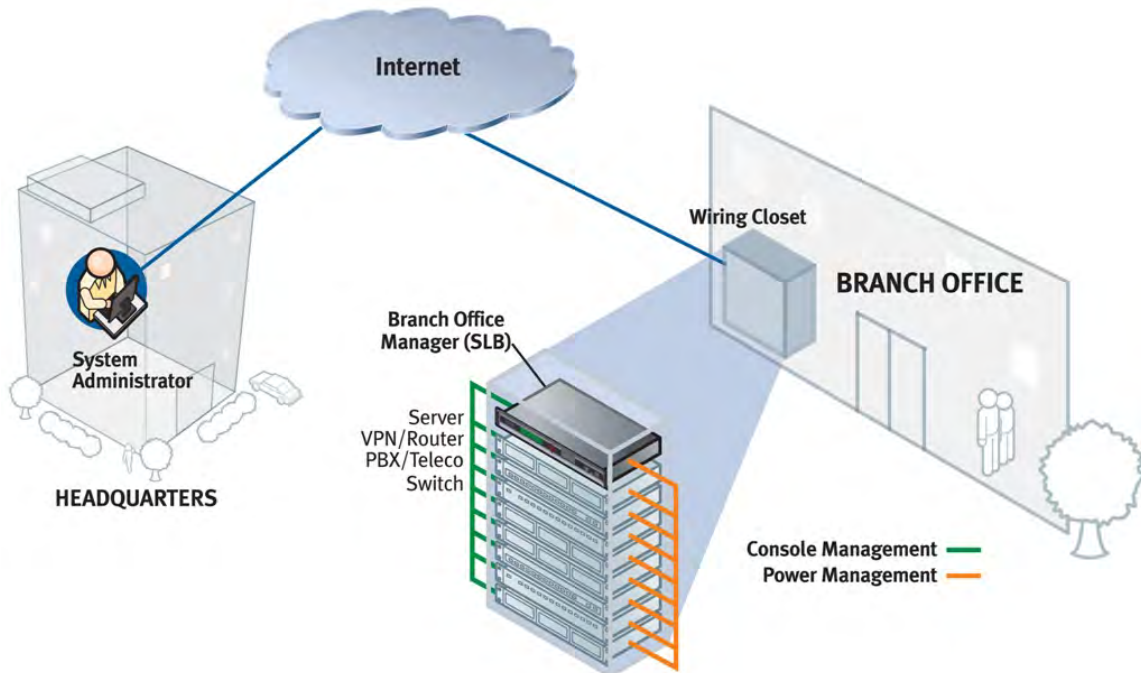

Designed for Branch Offices and Similar Environments

Designed to meet the specific needs of the remote branch offices and environments alike, the SLB branch office manager conserves rack space and reduces costs by enabling system administrators at a main corporate facility to manage the IT equipment distributed among branch offices simply and cost-effectively.

Branch offices are facilities that are typically remote or "distributed IT" locations, likely located off-site of corporate headquarters or large-scale enterprise facilities. These distributed facilities typically do not have an on-site maintenance staff or IT System Administrator.

Typically, the branch office environment has some of the following characteristics:

- ◆ Space is limited to 1U rack space or shelf mounted desktop unit
- ◆ Closet-mounted or wall-attached rack
- ◆ Limited air and power conditioning
- ◆ Limited number of network devices and servers
- ◆ No on-site maintenance staff
- ◆ Ethernet or dial-up modem access is required

Typical Equipment

You can configure, administer, and manage IT equipment in a variety of ways, but most devices have one method in common: an RS-232 serial port, sometimes called a console, auxiliary, or management port. These ports are often accessed directly by connecting a terminal or laptop to them, meaning that the user typically must be in the same physical location as the equipment. Eliminating the need for a physical presence, the Lantronix SLB unit provides remote access to the equipment from anywhere there is a network or modem connection.

The SLB branch office manager can access and administer many types of equipment, such as:

- ◆ Servers: Unix, Linux, Windows Server 2003 or higher, and others
- ◆ Networking equipment: Routers, switches, storage networking
- ◆ Telecom: PBX, voice switches
- ◆ Other systems with serial interfaces: Heating/cooling systems, security/building access systems, UPS, medial device.

Types of Business

The SLB unit is used in many types of environments, for example:

- ◆ Banking and finance
- ◆ Insurance companies
- ◆ Healthcare
- ◆ Retail Sales
- ◆ Information Technology
- ◆ Education and campus style facilities
- ◆ Hospitality
- ◆ Manufacturing Facilities
- ◆ Base Station Control and Management

Benefits

The key benefits of using the SLB branch office manager:

- ◆ Saves space: Compact design merges the functionality of two solutions into a 1U rack solution, reducing required rack space and total cost of ownership.
- ◆ Saves money: Enables remote management and troubleshooting without sending a technician onsite, resulting in reduced travel costs and increased network uptime.
- ◆ Saves time: Provides instant access and reduces response time, improving efficiency.
- ◆ Simplifies access: Enables 24/7 access to your equipment securely and remotely after hours and on weekends and holidays-without having to schedule visits or arrange for off-hour access.
- ◆ Protects assets: Provides the highest levels of encryption and security features (authentication, authorization, and IP filters) to ensure that your IT infrastructure and data assets are protected.

The SLB unit also provides features such as convenient text menu systems, break-safe operation, port buffering (logging), remote authentication, and Secure Shell (SSH) access. Dial-up modem support ensures access when the network is not available.

Models

The SLB branch office manager has the following hardware components:

- ◆ The 100-120 VAC SLB model is available in 100-120 VAC (50-60 Hz) NEMA 5-20R type outlets. This model also includes a USB port.
- ◆ The 200-240 VAC SLB model is available in 200-240 VAC (50-60 Hz) IEC C13 type outlets. This model also includes a USB port.
 - Note:** This model is EU style with one switched hot line, not a US style with two hot lines. It is intended for use on power systems where the 200-240VAC is provided on a single hot line.
- ◆ **Chassis:** The SLB unit has a 1U tall, self-contained rack-mountable chassis.
- ◆ **Power Outlets:** Eight outlets allow power management and control (on/off/reboot) of the attached equipment using a simple web or command line interface.
- ◆ **Serial Device Ports:** Eight serial RS-232C (EIA-232) device ports are for remote console management of the attached equipment. These match the RJ45 pin-outs of the console ports of many popular devices found in a network environment, and where different can be converted using Lantronix adapters. See the appendix, [Appendix C: Adapters and Pinouts](#) for more information on serial adapters and pin-outs.
- ◆ **Ports and Modem:** The SLB branch office manager has two 10/100 Ethernet ports (referred to in this user guide as Eth1 and Eth2) in the back and a front panel serial console port (RJ45). The SLB unit also includes a USB type A port in the front panel and an internal v.92 modem.

Table 2-2 SLB Models

Model	Description
100-120 VAC SLB	Branch Office Manager, 8 device ports, 8 power outlets (100-120 VAC, NEMA 5-20R type), 2 AC power inlets
200-240 VAC SLB	Branch Office Manager, 8 device ports, 8 power outlets (200-240 VAC, IEC C13 type), 2 AC power inlets

Figure 2-3 100-120 VAC SLB Unit



Figure 2-4 200-240 VAC SLB Unit



System Features

The SLB firmware has the following basic capabilities:

- ◆ Connects up to eight RS-232 serial consoles
- ◆ Controls power (on/off/reboot) of up to eight attached devices
- ◆ Per port current consumption monitoring
- ◆ Dual power inlets for failover. Both power inlets must be on the same phase.
- ◆ Dual 10Base-T/100Base-TX Ethernet network compatibility
- ◆ Buffer logging to file
- ◆ Email and SNMP notification
- ◆ ID/Password security, configurable access rights
- ◆ Secure shell (SSH) security; supports numerous other security protocols
- ◆ Network File System (NFS) and Common Internet File System (CIFS) support for configuration files
- ◆ TCP, Telnet or SSH to a serial port by IP address per port or by IP address and TCP port number
- ◆ Configurable user rights for local and remotely authenticated users
- ◆ Built-in internal modem
- ◆ External USB modem and Flash Storage supported
- ◆ Sun break-safe (no unintentional break ever sent to attached servers)
- ◆ Simultaneous access on the same port-- "listen" and "direct" connect mode
- ◆ Local access through a console port
- ◆ Web administration (using most browsers)

Protocols Supported

The SLB branch office manager supports the TCP/IP network protocol as well as:

- ◆ TCP, SSH, Telnet, PPP and NFS for connections in and out of, and CIFS for incoming connections to the `\\<hostname>\public\config` directory of the SLB unit
- ◆ SMTP for mail transfer
- ◆ DNS for text-to-IP address name resolution

- ◆ SNMP with custom traps for remote monitoring and management
- ◆ FTP and SFTP for file transfers and firmware upgrades
- ◆ TFTP and HTTPS for firmware upgrades
- ◆ DHCP and BOOTP for IP address assignment
- ◆ HTTPS (SSL) for secure browser-based configuration
- ◆ NTP for time synchronization
- ◆ LDAP, NIS, RADIUS, CHAP, PAP, Kerberos, and TACACS+ for user authentication
- ◆ IPsec for VPN access

For brief descriptions of these protocols, see [Appendix D: Protocol Glossary](#).

Access Control

The system administrator controls access to attached servers or devices by assigning access rights to up to 128 user profiles. Each user has an assigned ID, password, and access rights. Other user profile access options may include externally configured authentication methods such as RADIUS, TACACS+, NIS, and LDAP. Groups are supported in LDAP, RADIUS (via VSA), and TACACS+ (using `priv_lvl`).

Power Outlet Control

With the SLB unit's built-in power management capability, system administrators can remotely control the power (on/off/reboot) individually to all IT equipment in the branch office, ensure safe power distribution, and reduce "in-rush" current overload. If SNMP traps are enabled, a trap (alarm) is sent if the total current for all outlets exceeds a threshold.

Device Port Buffer

The SLB branch office manager supports real-time data logging for each device port. The port can save the data log to a file, send an email notification of an issue, or take no action.

You can define the path for logged data on a port-by-port basis, configure file size and number of files per port for each logging event, and configure the device log to send an email alert message automatically to the appropriate parties indicating a particular error.

Configuration Options

You may use the backlit front-panel LCD display for initial setup and configuration and to view current network, console, and date/time settings, and get power outlet status.

Both a web interface viewed through a standard browser and a command line interface (CLI) are available for configuring the SLB settings and monitoring performance.

Application Example

The figure below is an example deployment. An SLB unit is deployed in each branch office and an (optional) vSLM management appliance at the main office. The branch offices are interconnected (always on) by VPN routers overlaid on the Internet, and also interconnected (on demand) through the analog phone system.

The SLB unit provides remotely controlled and monitored AC power (orange), console management (green), and traditional, wired telephone network (PSTN) access (yellow).

Figure 2-5 Example Deployment

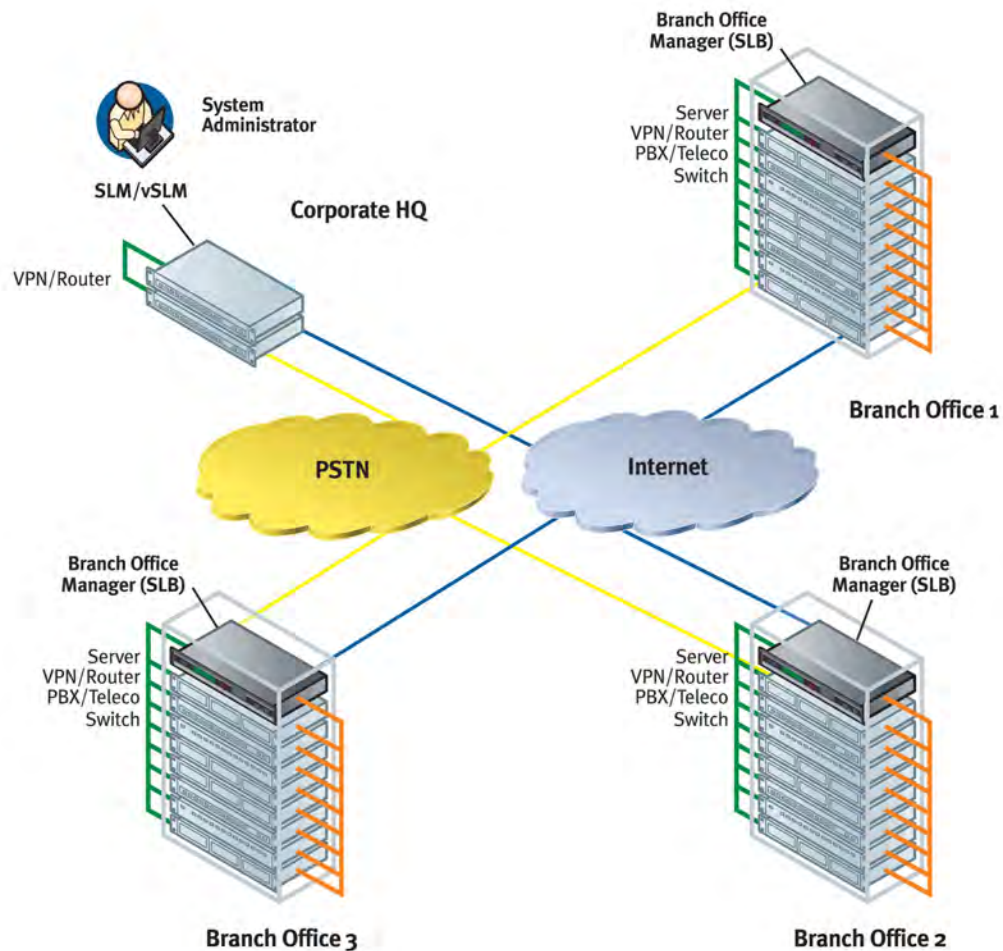

A system administrator, upon losing IP connectivity to a server, takes the following steps:

1. Views the server's Ethernet interface state information provided by the SLB branch office manager.
2. If the Ethernet interface is faulty, connects to the server's console port by means of the SLB web page or CLI (optionally via the vSLM management appliance) and checks the server's system parameters.
3. If the server is not responsive on the console port, commands the SLB to reboot the server's power.
4. If the entire branch office loses IP connectivity, dial in to the SLB to perform the diagnostic functions

Hardware Features

Caution: To avoid physical and electrical hazards, please read [Safety Precautions](#) before installing the SLB unit.

The SLB hardware includes the following:

- ◆ 1U-tall (1.75 inch) rack-mountable appliance

- ◆ Two 10Base-T/100Base-TX network ports
- ◆ One front panel serial console port for VT100 terminal or PC with emulation
- ◆ One USB Port
- ◆ Front panel LCD display and keypad
- ◆ One RJ-11 Internal Modem Port
- ◆ 256 KB-per-port buffer memory for serial device ports
- ◆ Eight RS-232 serial device ports connected via Category 5 (RJ45) wiring

Note: Max input/output is rated at 80% of the circuit max, per typical electrical codes.

- ◆ Dual AC Power Input

100-120 VAC SLB Model	<ul style="list-style-type: none"> ◆ Dual IEC-60320/C20 inlets, 100-120 VAC, 50/60Hz ◆ (20A Branch Circuit) 16A max input current
200-240 VAC SLB Model	<ul style="list-style-type: none"> ◆ Dual IEC-60320/C20 inlets, 200-240 VAC, 50/60Hz ◆ (20A Branch Circuit) 16A max input current

- ◆ Power Outlets (Total Switched Power)

100-120 VAC SLB Model	<ul style="list-style-type: none"> ◆ (8) NEMA 5-20R outlets, 100-120 VAC, 50/60Hz ◆ 16A max per outlet, 16A total for SLB
200-240 VAC SLB Model	<ul style="list-style-type: none"> ◆ (8) IEC C13 outlets, 200-240 VAC, 50/60Hz ◆ 10A max per outlet, 16A total for SLB (15.9A max total for China CCC)

Note: The outlet voltage equals the input voltage.

- ◆ Convection cooled, silent operation, low power consumption

Note: For more detailed information, see [Technical Specifications \(on page 32\)](#).

Serial Connections

All devices attached to the device ports and the console port must support the RS-232C (EIA-232) standard. Category 5 cabling with RJ45 connections is used for the device port connections and for the console port. (For pinout information, see [Adapters and Pinouts on page 338](#).)

Note: RJ45 to DB9/DB25 adapters are available from Lantronix.

Device ports and the console port support the following baud-rate options: 300, 600, 1200, 2400, 4800, 9600, 19200, 38400, 57600, 115200, and 230400 baud.

Figure 2-6 Device Port Connections



Figure 2-7 Console Port Connection



Network Connections

The SLB network interfaces are 10Base-T/100Base-TX connectors for use with a conventional Ethernet network. Use standard RJ45-terminated Category 5 cables. Network parameters must be configured before the SLB branch office manager can be accessed over the network.

Note: One possible use for the two Ethernet ports is to have one port on a private, secure network and the other on a public, unsecured network.

Figure 2-8 Network Connection



USB Interface

The SLB unit has a USB port. Lantronix qualifies USB devices continuously.

Figure 2-9 USB Interface



Modem Interface

The SLB branch office manager has one v92 modem RJ11 interface to allow configuration and control of the unit via dialing into the unit.

Caution: *To reduce the risk of fire, use only No. 26 AWG or larger (e.g., 24 AWG) UL Listed or CSA Certified Telecommunication Line Cord.*

Attention: *Pour réduire les risques d'incendie, utiliser uniquement des conducteurs de télécommunications 26 AWG au de section supérieure.*

Figure 2-10 Modem Interface



3: Installation

This chapter provides a high-level procedure for installing the SLB branch office manager followed by more detailed information about the SLB connections and power supplies.

What's in the Box

In addition to the SLB branch office manager, the following table lists components in the box and their corresponding part numbers.

Table 3-1 Part Numbers and Descriptions for Adapters and Cables

Part #	Component Description
Adapters:	
200.2066A	Adapter: DB25M (DCE), Sun w/DB25 female
200.2067A	Adapter: DB25F (DCE) to RJ45, Sun w/DB25 male and some HP9000's
200.2069A	Adapter: DB9M (DCE) to RJ45, SGI Onyx
200.2070A	Adapter: DB9F (DCE) to RJ45, HP9000, SGI Origin, IBM RS6000, and PC-based Linux servers
ADP010104-01	Adapter: RJ45 rolled serial, Cisco, and Sun Netra
<i>Note: The following optional adapters are available from Lantronix: 200.2073 Adapter: DB25M (DTE) to RJ45, external modems. 200.2071 Adapter: DB9M (DTE) to convert the RJ45 serial connector to a PC style D-sub serial port</i>	
Cables:	
200.0063	Cable: RJ45 to RJ45, Cat-5, 6.6 ft (2 m)
500-153	Cable: RJ45 Loopback

Table 3-2 Part Numbers and Descriptions for Power Cords

Model	Part Number	Description
100-120 VAC SLB*	SLB882KIT-15P	◆ SLPP12310-01 Inlet cord: IEC60320/C19 to NEMA 5-15P (15A)
	SLB882KIT-20P	◆ SLPP12410-01 Inlet cord: IEC60320/C19 to NEMA 5-20P (20A)
200-240 VAC SLB*	SLB8824KIT-EU	◆ SLPP12810-01 Inlet cord: IEC60320/C19 to Schuko (EU) ◆ SLPP12910-01 Inlet cord: IEC60320/C19 to BS1363 (UK)
	SLB8824KIT-AP	◆ SLPP12A08-01 Inlet cord: IEC60320/C19 to AS/NZS 3112 (AU/NZ) ◆ SLPP12C08-01 Inlet cord: IEC60320/C19 to CHINA/GB (CN)
* Included power cords vary for kit purchased. Please see www.lantronix.com for additional inlet power cords available.		

Verify and inspect the contents of the SLB package using the enclosed packing slip or the table above. If any item is missing or damaged, contact your place of purchase immediately.

Product Information Label

The product information label on the underside of the SLB branch office manager contains the following information about each SLB unit:

- ◆ Part Number
- ◆ Serial Number Bar Code
- ◆ Serial Number and Date Code
- ◆ Regulatory Certifications and Statements

Technical Specifications

Note: The SLB branch office manager is intended for use in Single Phase systems.

Table 3-3 SLB Technical Specifications

Component	Description
Serial Interface (Device)	(8) RJ45-type 8-conductor connector (DTE) Speed software selectable (300 to 230,400 baud)
Serial Interface (Console)	(1) RJ45-type 8-pin connector (DTE) Speed software selectable (300 to 230,400 baud)
Power Input	100-120 VAC SLB Model <ul style="list-style-type: none"> ◆ (2) IEC-60320/C20 inlet, 100-120 VAC, 50/60Hz ◆ (20A Branch Circuit) 16A max input current 200-240 VAC SLB Model <ul style="list-style-type: none"> ◆ (2) IEC-60320/C20 inlet, 200-240 VAC, 50/60Hz ◆ (20A Branch Circuit) 16A max input current
Note: The max input current is de-rated to figures listed in Table 3-4 when using specified power cords.	
Power Outlets	100-120 VAC SLB Model <ul style="list-style-type: none"> ◆ (8) NEMA5-20R outlets, 100-120 VAC, 50/60Hz ◆ (20A Branch Circuit) 16A max per outlet, 16A total ◆ Individual current sensor for monitoring power draw on each outlet ◆ Output power switchable via independent relay for each outlet 200-240 VAC SLB Model <ul style="list-style-type: none"> ◆ (8) IEC C13 outlets, 200-240 VAC, 50/60Hz ◆ (20A Branch Circuit) 10A max per outlet, 16A total (15.9A max total for China CCC) ◆ Individual current sensor for monitoring power draw on each outlet ◆ Output power switchable via independent relay for each outlet. Single pole only. Not suitable for two hot line power systems.
Modem Interface	RJ11 Jack for connection to internal v92 dial up modem. Note: To reduce the risk of fire, use only No. 26 AWG or larger (e.g., 24 AWG) UL Listed or CSA Certified Telecommunication Line Cord.
Network Interface	Dual 10Base-T/100Base-TX RJ45 Ethernet
Power Consumption	Less than 30 watts. Applies only to the operation of the SLB branch office manager and not to the current it is switching.

Component (continued)	Description
Dimensions	1U, 1.7 in x 18.9 in x 12.4 in
Weight	10 lb.
Temperature	Operating: 0 to 50 °C (32 to 122 °F) Storage: -20 to 70 °C (-4 to 158 °F)
Relative Humidity	Operating: 10% to 90% non-condensing Storage: 10% to 90% non-condensing
Current measurement accuracy	1A to 16A

Table 3-4 Max Current per Power Cord Used

Power Cord Used	Description
SLPP12310-01	Inlet cord: IEC60320/C19 to NEMA 5-15P (15A) <i>Note: Unit input current is de-rated to 12A maximum when using this cable.</i>
SLPP12410-01	Inlet cord: IEC60320/C19 to NEMA 5-20P (20A) <i>Note: Unit input current is de-rated to 16A maximum when using this cable.</i>
SLPP12810-01	Inlet cord: IEC60320/C19 to Schuko (EU/16A)
SLPP12910-01	Inlet cord: IEC60320/C19 to BS1363 (UK/13A)
SLPP12A08-01	Inlet cord: IEC60320/C19 to AS/NZS 3112 (AU/NZ/15A)
SLPP12C08-01	Inlet cord: IEC60320/C19 to CHINA/GB (CN/16A)

Safety Precautions

Please follow the safety precautions described below when installing and operating the SLB branch office manager.

Cover

- ◆ Do not remove the cover of the chassis. There are no user-serviceable parts inside. Opening or removing the cover may expose you to dangerous voltage that could cause fire or electric shock.
- ◆ Refer all servicing to Lantronix.

Power Plug

- ◆ When disconnecting the power cable from the socket, pull on the plug, not the cord.
- ◆ Always connect the power cord to a properly wired and grounded power source. Do not use adapter plugs or remove the grounding prong from the cord.
- ◆ Only use a power cord with a voltage and current rating greater than the voltage and current rating marked on the SLB.
- ◆ Install the SLB unit near an AC outlet that is easily accessible.
- ◆ Always connect any equipment used with the product to properly wired and grounded power sources.

- ◆ Always connect the unit with the proper polarity at the inlet connector. See [Figure 3-5](#). Failure to do so may cause downstream hazards on connected devices.

Figure 3-5 Inlet Pin Assignment

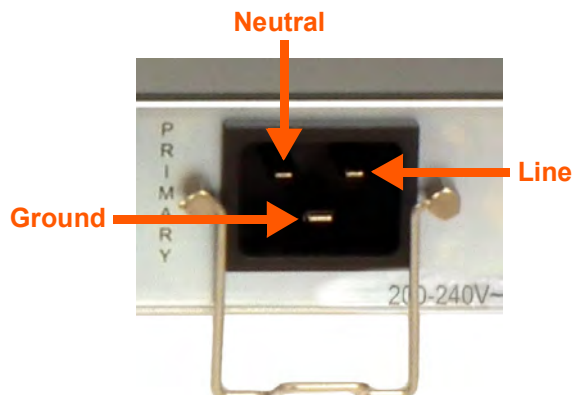

- ◆ To help protect the product from sudden, transient increases and decreases in electrical power, use a surge suppressor, line conditioner, or uninterruptible power supply (UPS).
- ◆ Do not connect or disconnect this product during an electrical storm.

Input Supply

Caution: *This SLB device may have more than one power supply source. Disconnect all power supply sources before servicing to avoid electric shock. Disconnect downstream device power cables prior to servicing the downstream device.*

Note: *The SLB branch office manager is intended for use in Single Phase systems.*

- ◆ Check nameplate ratings to assure there is no overloading of supply circuits that could affect over current protection and supply wiring.

Grounding

1. Maintain reliable grounding of this product.
2. Pay particular attention to supply connections when connecting to power strips, rather than directly to the branch circuit.

Fuses

- ◆ For protection against fire, replace the power-input-module fuse with the same type and rating.

Rack

If rack mounted SLB branch office managers are installed in a closed or multi-unit rack assembly, they may require further evaluation by Certification Agencies. The following items must be considered:

- ◆ Do not install the SLB unit in a rack in such a way that a hazardous stability condition results because of uneven loading. A drop or fall could cause injury.
- ◆ The ambient temperature (T_{ma}) inside the rack may be greater than the room ambient temperature. Make sure to install the SLB branch office manager in an environment with an ambient temperature less than the maximum operating temperature of the SLB unit. (See [Technical Specifications on page 32.](#))
- ◆ Install the equipment in a rack in such a way that the amount of airflow required for safe operation of the equipment is not compromised.
- ◆ Mount the equipment in the rack so that a hazardous condition is not achieved due to uneven mechanical loading.
- ◆ Maintain reliable earthing of rack-mounted equipment. Give particular attention to supply connections other than direct connections to the branch circuit (e.g. use of power strips).
- ◆ Before operating the SLB branch office manager, make sure the SLB unit is secured to the rack.

Port Connections

- ◆ Only connect the network port to an Ethernet network that supports 10Base-T/100Base-T.
- ◆ Only connect device ports to equipment with serial ports that support EIA-232 (formerly RS-232C).

Only connect the console port to equipment with serial ports that support EIA-232 (formerly RS-232C).

Physical Installation

To install the SLB branch office manager in a rack:

1. Place the SLB unit in a 19-inch rack.

Warning: *Do not to block the air vents on the sides of the SLB device. If you mount the SLB branch office manager in an enclosed rack, we recommended that the rack have a ventilation fan to provide adequate airflow through the SLB unit.*

2. Connect the serial device(s) to the SLB device ports. See the section, [Connecting to a Device Port \(on page 36\)](#).
3. Choose one of the following options:
 - ◆ To configure the SLB branch office manager using the network, or to monitor serial devices on the network, connect at least one SLB network port to a network. See [Connecting to Network Ports \(on page 36\)](#).
 - ◆ To configure the SLB branch office manager using a dumb terminal or a computer with terminal emulation, connect the terminal or PC to the SLB console port. See [Connecting Terminals \(on page 37\)](#).
4. Connect the power cord, and apply power. See [Power \(on page 37\)](#).
5. Wait approximately a minute and a half for the boot process to complete. If a terminal is connected to the front panel serial console port the boot messages will be displayed on the

terminal.

When the boot process ends, the SLB host name and the clock or the power supply status appear on the LCD display. Now you are ready to configure the network settings as described in [Chapter 4: Quick Setup on page 41](#).

Connecting to a Device Port

You can connect almost any device that has a serial console port to a device port on the SLB unit for remote administration. The console port must support the RS-232C interface.

Note: Many servers must either have the serial port enabled as a console or the keyboard and mouse detached. Consult the server hardware and/or software documentation for more information.

To connect to a device port:

1. Connect one end of the Cat 5 cable to a device port on the SLB unit front panel.
2. Connect the other end of the Cat 5 cable to a Lantronix serial console adapter.

Note: To connect a device port to a Lantronix SLP™ power management, use the ADP010104 adapter and a Cat5 patch cable between the adapter and the connected equipment. See the appendix, [Adapters and Pinouts on page 338](#) for more information about Lantronix adapters.

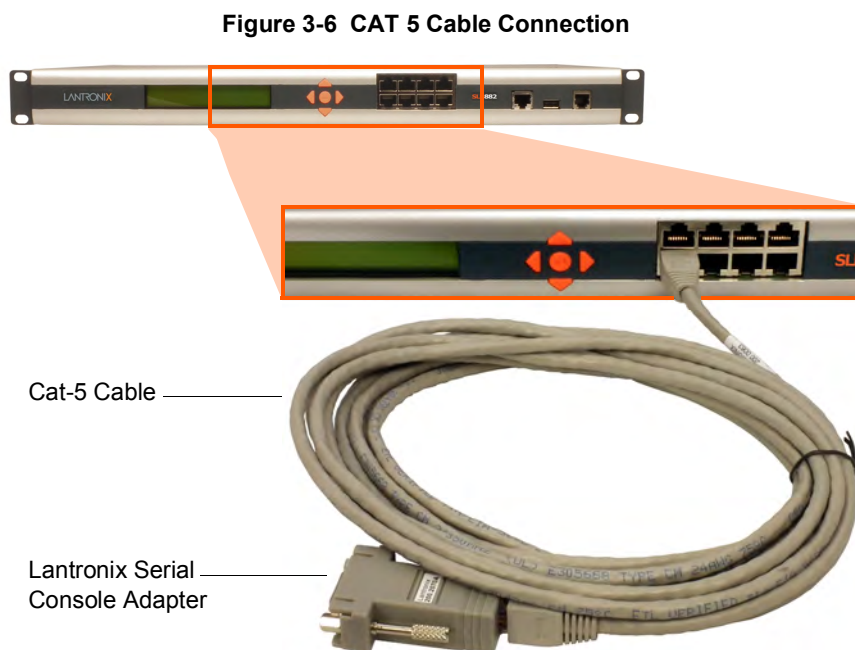

3. Connect the adapter to the serial console port on the serial device.

Connecting to Network Ports

The SLB branch office manager's network ports, 10Base-T/100Base-TX, allow remote access to the attached devices and the system administrative functions. Use a standard RJ45-terminated Category 5 cable to connect to the network port.

Note: One possible use for the two Ethernet ports is to have one port on a private, secure network, and the other on an unsecured network. Ethernet bonding is also supported.

Connecting Terminals

The console port is for local access to the SLB unit and the attached devices. You may attach a dumb terminal or a computer with terminal emulation to the console port. The SLB console port uses RS-232C protocol and supports VT100 emulation. The default baud rate is 9600.

To connect the console port to a terminal or computer with terminal emulation, Lantronix offers optional adapters that provide a connection between an RJ45 jack and a DB9 or DB25 connector. The console port is configured as DTE. For more information, see the appendix, [Adapters and Pinouts on page 338](#) and our Web site at www.lantronix.com/support and click **Cable/Adapter Lookup** on the Support menu.

To connect a terminal:

1. Attach the Lantronix adapter to your terminal (use PN 200.2066A adapter) or your PC's serial port (use PN 200.2070A adapter).
2. Connect the Cat 5 cable to the adapter, and connect the other end to the SLB console port.
3. Turn on the terminal or start your computer's communication program (e.g., HyperTerminal for Windows XP or lower. For recent versions of Windows use a free terminal emulator such as PuTTY or TeraTerm Pro).
4. Once the SLB branch office manager is running, press **Enter** to establish connection. You should see the model name and a login prompt on your terminal. You are connected.

Connecting to the Internal Modem

1. Connect an RJ11 telecommunication cable to the modem port on the front of the unit.
2. Connect the other end of the cable to an analog phone connector on your telephone network.

Caution: To reduce the risk of fire, use only No. 26 AWG or larger (e.g., 24 AWG) UL Listed or CSA Certified Telecommunication Line Cord.

Power

The SLB unit consumes less than 30W of electrical power.

Note: Switched currents may be 30W or greater.

AC Input

The SLB branch office manager has a universal auto-switching dual AC inlet power supply. The power supply for the 100-120 VAC SLB controller accepts AC input voltage between 100 and 120 VAC with a frequency of 50 or 60 Hz. The power supply for the 200-240 VAC SLB controller accepts AC input voltage between 200 and 240 VAC with a frequency of 50 or 60 Hz. Rear-mounted IEC-type AC power connectors are provided for universal AC power input on a single hot line. US style two hot line 200-240VAC power is not supported. (See [What's in the Box on page 31.](#))

Caution: This unit may have more than one power supply source. Disconnect all power supply sources before servicing to avoid electric shock.

Figure 3-7 AC Power Input



One of the SLB dual AC power inputs is the designated primary power source and the other is designated as the secondary source. If both are used, the power will be drawn by the primary power source. If the primary power source should fail, power will be drawn through the secondary power source. Once power is restored to the primary power source, the power will be switched back from the secondary power source to the primary power source. Both power sources must be on the same phase. Using power from different phases will cause the relay to malfunction and possibly cause damage to the SLB.

Connecting Devices to Power Outlets

To avoid the possibility of noise due to arcing:

1. Keep the device's on/off switch in the off position until after it is plugged into the outlet, or log in to the SLB branch office manager and turn the outlets off before connecting the devices.
2. Connect devices to the outlets.

Figure 3-8 100-120 VAC SLB - Branch Office Manager Power Outlets



Figure 3-9 200-240 VAC SLB - Branch Office Manager Power Outlets



The default screen under **Maintenance->LCD/Keypad** can be modified, but by default, the status of the power outlets displays on the front panel LCD.

Typical Installations

Following are illustrations showing some typical ways to install the SLB branch office manager. In [Figure 3-10](#), three serial devices (a server, a Cisco switch, and a firewall) connect to the SLB unit's serial ports and power outlets. This setup enables the SLB branch office manager to manage the devices and provide power to the devices. In addition, the SLB unit includes a built-in modem for out-of-band dial-up access.

Figure 3-10 100-120 VAC SLB Installation Diagram

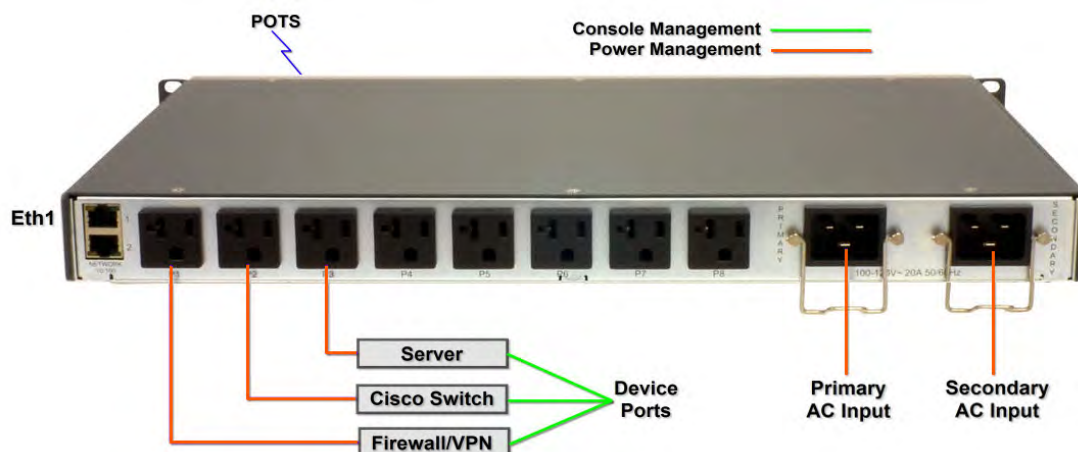
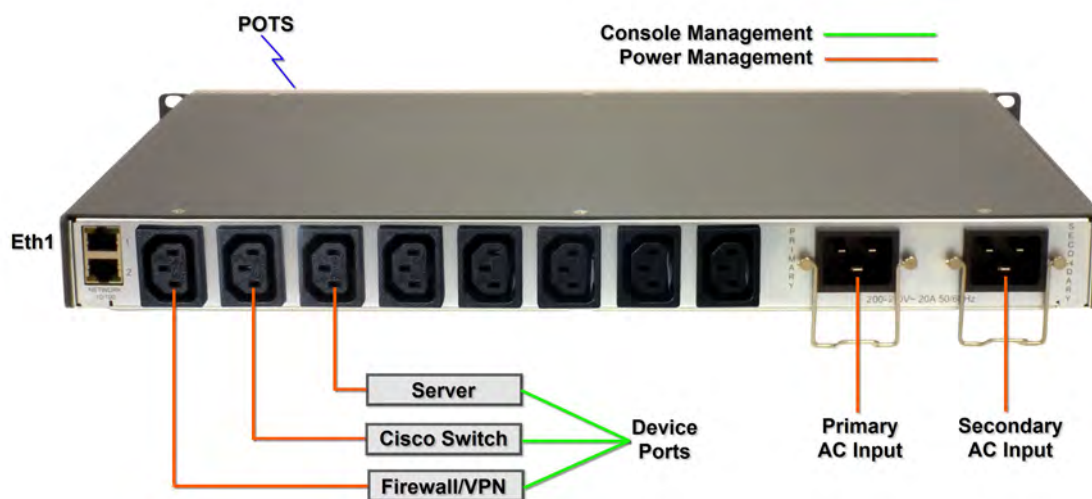

Figure 3-11 200-240 VAC SLB Installation Diagram



The SLB device controls up to eight serial devices and provides power to them. The devices use a separate user supplied Ethernet switch to connect to the network.

4: Quick Setup

This chapter helps get the IP network port up and running quickly, so you can administer the SLB branch office manager using your network.

Recommendations

To set up the network connections quickly, we suggest you do one of the following:

- ◆ Use the front panel LCD display and keypads.
- ◆ Complete the [Quick Setup](#) on the web interface.
- ◆ SSH to the command line interface and follow the Quick Setup script on the command line interface.
- ◆ Connect to the console port and follow the Quick Setup script on the command line interface.

Note: *The first time you power up the SLB unit, Eth1 tries to obtain its IP address via DHCP. If you have connected Eth1 to the network, and Eth1 is able to acquire an IP address, you can view this IP address on the LCD or by running the Lantronix® DeviceInstaller™ utility. If Eth1 cannot acquire an IP address, you cannot use Telnet, SSH, or the web interface to run Quick Setup.*

IP Address

Your SLB unit must have a unique IP address on your network. The system administrator generally provides the IP address and corresponding subnet mask and gateway. The IP address must be within a valid range, unique to your network, and in the same subnet as your PC if you are using the DeviceInstaller utility.

The following table lists the options for assigning an IP address to your SLB branch office manager.

Table 4-1 Methods of Assigning an IP Address

Method	Description
DHCP	A DHCP server automatically assigns the IP address and network settings. The SLB unit is DHCP-enabled by default. With the Eth1 network port connected to the network, and the SLB device powered up, Eth1 acquires an IP address, viewable on the LCD. At this point, you can use SSH or Telnet to connect to the SLB branch office manager, or use the web interface.
BOOTP	Similar to DHCP but for smaller networks.
DeviceInstaller™	The Lantronix DeviceInstaller utility is a Windows-based GUI application that provides an easy way to install and configure specific Lantronix device server products. You may utilize DeviceInstaller to assign an IP and other network specific addresses.
Front panel LCD display and keypads	You manually assign the IP address and other basic network, console, and date/time settings. If desired, you can restore the factory defaults.

Method (continued)	Description
Serial port login to command line interface	You assign an IP address and configure the SLB branch office manager using a terminal or a PC running a terminal emulation program to the SLB unit's serial console port connection.

Method #1 Using the Front Panel Display

Before you begin, ensure that you have:

- ◆ Unique IP address that is valid on your network (unless automatically assigned)
- ◆ Subnet mask (unless automatically assigned)
- ◆ Gateway
- ◆ DNS settings
- ◆ Date, time, and time zone
- ◆ Console port settings: baud rate, data bits, stop bits, parity, and flow control

Make sure the SLB branch office manager is plugged into power and turned on.

Front Panel LCD Display and Keypads

With the SLB unit powered up, you can use the front panel display and keypad buttons to set up the basic parameters.

Figure 4-2 Front Panel LCD Display and Five Button Keypads (Enter, Up, Down, Left, Right)



The front panel display initially shows the hostname (abbreviated to 14 letters), total current level, and state of the power supply.

When you click the right-arrow keypad buttons, the SLB network settings display. Using the five keypad buttons, you can change the network, console port, and date/time settings and view the firmware release version. If desired, you can restore the factory defaults.

Note: *Have your information handy as the display times out without accepting any unsaved changes if you take more than 30 seconds between entries.*

Any changes made to the network, console port, and date/time settings take effect immediately.

Navigating



The front panel keypad has one **Enter** button (in the center) and four arrow buttons (up, left, right, and down). Press the arrow buttons to navigate from one option to another, or to increment or decrement a numerical entry of the selected option. Use the **Enter** button to select an option to change or to save your settings.

The following table lists the SLB navigation actions, buttons, and options.

Table 4-3 LCD Arrow Keypad Actions

Button	Action
Right arrow	To move to the next option (e.g., from Network Settings to Console Settings)
Left arrow	To return to the previous option
Enter (center button)	To enter edit mode
Up and down arrows	Within edit mode, to increase or decrease a numerical entry
Right or left arrows	Within edit mode, to move the cursor right or left
Enter	To exit edit mode
Up and down arrows	To scroll up or down the list of parameters within an option (e.g., from IP Address to Mask)

Table 4-4 Front Panel Setup Options with Associated Parameters

	Network Settings	Console Settings	Date / Time Settings	Release	Power	Internal Temp	User Strings	Location	Device Ports	Current Time
 Up/ Down Arrow 	Eth1 IP Address	Baud Rate	Time Zone	Firmware version and date code (display only)	Power Inlets	Reading in Celsius & Fahrenheit	Displays configured user string(s), if any.	Indicates the Rack (RK), Row (RW) & Cluster (CW) locations.	Detects the connection state of each port: 0=No serial connection 1=Serial connection detected.	User ID & Current Time
	Eth1 Subnet Mask	Data Bits	Date/Time	Restore Factory Defaults	Outlet 1 - 8 On/Off Status					
	Gateway	Stop Bits			Outlet 1 - 8 Reading					
	DNS1	Parity								
	DNS2	Flow Control								
	DNS3									

Note: The individual screens listed from left to right in [Table 4-4](#) can be enabled or disabled for display on the SLB LCD screen. The order of appearance of the screens, if enabled, along with the elected “Home Page” may vary on the LCD monitor according to configuration. See [LCD/Keypad \(on page 244\)](#) for instructions on enabling and disabling screens.

Entering the Settings

To enter setup information:

1. From the normal display (host name, date and time or power supply status), press the right arrow button to display Network Settings. The IP address for Eth1 displays.

Note: If you have connected Eth1 to the network, and Eth1 is able to acquire an IP address through DHCP, this IP address displays, followed by the letter [D]. Otherwise, the IP address displays as all zeros (000.000.000.000).

2. Press the **Enter** button on the keypad to enter edit mode. A cursor displays below one character of the existing IP address setting.
3. To enter values:
 - ◆ Use the left or right arrow to move the cursor to the left or to the right position.
 - ◆ Use the up or down arrow to increment or decrement the numerical value.
4. When you have the set IP address as you want it, press **Enter** to exit edit mode, and then press the down arrow button. The Subnet Mask parameter displays.

Note: You must edit the IP address and the Subnet Mask together for a valid IP address combination.

5. To save your entries for one or more parameters in the group, press the right arrow button. The Save Settings? Yes/No prompt displays.

Note: If the prompt does not display, make sure you are no longer in edit mode.

6. Use the left/right arrow buttons to select **Yes**, and press the **Enter** button.
7. Press the right arrow button to move to the next option, **Console Settings**.
8. Repeat steps 2-7 for each setting.
9. Press the right arrow button to move to the next option, **Date/Time Settings**, and click **Enter** to edit the time zone.
 - ◆ To enter a US time zone, use the up/down arrow buttons to scroll through the US time zones, and then press **Enter** to select the correct one.
 - ◆ To enter a time zone outside the US, press the left arrow button to move up to the top level of time zones. Press the up/down arrow button to scroll through the top level.

A time zone with a trailing slash (such as Africa/) has sub-time zones. Use the right arrow button to select the Africa time zones, and then the up/down arrows to scroll through them.

Press **Enter** to select the correct time zone. To move back to the top-level time zone at any time, press the left arrow.
10. To save your entries, press the right arrow button. The **Save Settings? Yes/No** prompt displays.

Note: If the prompt does not display, make sure you are no longer in edit mode.

11. Use the left/right arrow buttons to select **Yes**, and press the **Enter** button.
12. To review the saved settings, press the up or down arrows to step through the current settings.

When you are done, the front panel returns to the clock display. The network port resets to the new settings, and you can connect to your IP network for further administration. You should be able to SSH to the SLB branch office manager through your network connection, or access the Web interface through a Web browser.

Restoring Factory Defaults

To use the LCD display to restore factory default settings:

1. Press the right arrow button to move to the last option, **Release**.
2. Use the down arrow to move to the **Restore Factory Defaults** option. A prompt for the 6-digit Restore Factory Defaults password displays.
3. Press **Enter** to enter edit mode.
4. Using the left and right arrows to move between digits and the up and down arrows to change digits, enter the password (the default password is 999999).

Note: The Restore Factory Defaults password is only for the LCD. You can change it at the command line interface using the `admin keypad password` command.

5. Press **Enter** to exit edit mode. If the password is valid, a **Save Settings? Yes/No** prompt displays.
6. To initiate the process for restoring factory defaults, select **Yes**. When the process is complete, the SLB branch office manager reboots.

Limiting Sysadmin User Access

For security purposes, full administrative access to the SLC or SLB via the default sysadmin local user account can be limited to only the front console port of the SLC or SLB device.

To configure this:

1. Enable the Sysadmin access limited to Console Port option on the Local/Remote Users web page.
2. Enable a remote authentication method (such as TACACS+ or LDAP) and configure the remote authentication method to be first in the order of methods used.
3. Create a remote user account with full administrative rights.
4. Uncheck the Attempt next method on authentication rejection checkbox on the Authentication Methods web page.

These steps will prevent any local users from logging in, restrict the default sysadmin local user to the front console port, and allow a user with administrative rights to login, as long as remote authentication is working.

To use DHCP to restore a configuration to a factory defaulted SLB:

Utilize the [Zero Touch Provisioning Configuration Restore](#) feature, to acquire a default configuration from a DHCP server and TFTP server when it is booted.

1. At boot time, before the normal startup process, a unit will attempt to acquire network parameters and a configuration file, first over Eth1.
2. A unit will then attempt to acquire network parameters and a configuration file over Eth2.
3. See [SLB Maintenance \(on page 226\)](#) for more information.

Method #2 Quick Setup on the Web Page

After the unit has an IP address, you can use the [Quick Setup](#) page to configure the remaining network settings. This page displays the first time you log into the SLB unit only. Otherwise, the SLB Home Page displays.

To complete the Quick Setup page:

1. Open a web browser (Firefox, Chrome or Internet Explorer with JavaScript enabled).
2. In the URL field, type `https://` followed by the IP address of your SLB.

Note: The web server listens for requests on the unencrypted (HTTP) port (port 80) and redirects all requests to the encrypted (HTTPS) port (port 443).

3. Log in using `sysadmin` as the user name and `PASS` as the password. The first time you log in to the SLB, the [Quick Setup](#) page automatically displays. Otherwise, the Home page displays.

Note: To open the Quick Setup page at another time, click the [Quick Setup](#) tab.

Figure 4-5 Quick Setup

LANTRONIX[®] SLB882/8824

Logout Host: slbdb40 User: sysadmin

Select port for Configuration WebSSH (DP only) Connected Device (DP only)

Network Services User Authentication Devices Maintenance Quick Setup

Quick Setup [Help?](#)

Welcome to the Secure Lantronix Branch Office Manager

Below are basic settings that it is recommended you configure before using the Secure Lantronix Branch Office Manager. If these settings are OK, click the checkbox below and select the Apply button.

Accept default Quick Setup settings

Network Settings

Eth1 Settings: Obtain from DHCP Obtain from BOOTP Specify:

IP Address: Subnet Mask:

The SLB has two Ethernet ports, Eth1 and Eth2. By default, both Eth1 and Eth2 are configured for DHCP.

Default Gateway: Hostname:

Note: The hostname will be used as the prompt in the Command Line Interface. Domain:

Date & Time Settings

Change Date/Time:

Date:

Time: :

Time Zone:

Administrator Settings

The **sysadmin** user has complete privileges for SLB administration. The default password is 'PASS'.

Sysadmin Password:

Retype Password:

- To accept the defaults, select the **Accept** default Quick Setup settings checkbox in the top portion of the page and click the **Apply** button at the bottom of the page. Otherwise, continue with step 5.

Note: Once you click the **Apply** button on the Quick Setup page, you can continue using the web interface to configure the SLB branch office manager further.

- Enter the following settings:

Network Settings

Note: Configurations with the same IP subnet on multiple interfaces (Ethernet or PPP) are not currently supported.

Network Setting	Description
Eth 1 Settings	<ul style="list-style-type: none"> ◆ Obtain from DHCP: Acquires IP address, subnet mask, hostname and gateway from the DHCP server. (The DHCP server may not provide the hostname gateway, depending on its setup.) This is the default setting. If you select this option, skip to Gateway. ◆ Obtain from BOOTP: Lets a network node request configuration information from a BOOTP "server" node. If you select this option, skip to Gateway. ◆ Specify: Lets you manually assign a static IP address, generally provided by the system administrator.
IP Address (if specifying)	<ul style="list-style-type: none"> ◆ Enter an IP address that is unique and valid on your network. There is no default. ◆ Enter all IP addresses in dot-quad notation. Do not use leading zeros in the fields for dot-quad numbers less than 100. For example, if your IP address is 172.19.201.28, do not enter 028 for the last segment. <p>Note: Currently, the SLB unit does not support configurations with the same IP subnet on multiple interfaces (Ethernet or PPP).</p>
Subnet Mask	If specifying an IP address, enter the subnet mask for the network on which the SLB device resides. There is no default.
Default Gateway	The IP address of the router for this network. There is no default.
Hostname	The default host name is slbXXXX, where XXXX is the last 4 characters of the hardware address of Ethernet Port 1. There is a 64-character limit (contiguous characters, no spaces). The host name becomes the prompt in the command line interface.
Domain	If desired, specify a domain name (for example, support.lantronix.com). The domain name is used for host name resolution within the SLB unit. For example, if abcd is specified for the SMTP server, and mydomain.com is specified for the domain, if abcd cannot be resolved, the SLB branch office manager attempts to resolve abcd.mydomain.com for the SMTP server.

Date & Time Settings

Date & Time Setting	Description
Change Date/Time	Select the checkbox to manually enter the date and time at the SLB's location.
Date	From the drop-down lists, select the current month, day, and year.
Time	From the drop-down lists, select the current hour and minute.
Time Zone	From the drop-down list, select the appropriate time zone.

Administrator Settings

Administrator Setting	Description
Sysadmin Password	To change the password (e.g., from the default) enter a Sysadmin Password of up to 64 characters.
Retype Password	Re-enter the Sysadmin Password above in this field as a confirmation.

6. Click the **Apply** button to save your entries.

Method #3 Quick Setup on the Command Line Interface

If the SLB branch office manager does not have an IP address, you can connect a dumb terminal or a PC running a terminal emulation program (VT100) to access the command line interface. (See [Connecting Terminals on page 37](#).) If the unit has an IP address, you can use SSH or Telnet to connect to the SLB.

Note: By default, Telnet is disabled and SSH is enabled. To enable Telnet, use the [Services > SSH/Telnet/Logging](#) page (see [Chapter 7: Services on page 84](#)), a serial terminal connection, or an SSH connection.

To complete the command line interface Quick Setup script:

1. Do one of the following:
 - ◆ With a serial terminal connection, power up, and when the command line displays, press **Enter**.
 - ◆ With a network connection, use an SSH program or Telnet program (if Telnet has been enabled) to connect to `xx.xx.xx.xx` (the IP address in dot quad notation), and press **Enter**. You should be at the login prompt.
2. Enter `sysadmin` as the user name and press **Enter**.
3. Enter `PASS` as the password and press **Enter**. The first time you log in, the Quick Setup script runs automatically. Normally, the command prompt displays.

Figure 4-6 Beginning of Quick Setup Script

Quick Setup will now step you through configuring a few basic settings.

The current settings are shown in brackets ('[]').

You can accept the current setting for each question by pressing `<return>`.

4. Enter the following information at the prompts:

Note: To accept a default or to skip an entry that is not required, press **Enter**.

CLI Quick Setup Settings	Description
Configure Eth1	Select one of the following: <ul style="list-style-type: none"> ◆ <1> obtain IP Address from DHCP: The unit will acquire the IP address, subnet mask, hostname, and gateway from the DHCP server. (The DHCP server may or may not provide the gateway and hostname, depending on its setup.) This is the default setting. ◆ <2> obtain IP Address from BOOTP: Permits a network node to request configuration information from a BOOTP "server" node. ◆ <3> static IP Address: Allows you to assign a static IP address manually. The IP address is generally provided by the system administrator.

CLI Quick Setup Settings	Description
IP Address (if specifying)	An IP address that is unique and valid on your network and in the same subnet as your PC. There is no default. If you selected DHCP or BOOTP , this prompt does not display. Enter all IP addresses in dot-quad notation. Do not use leading zeros in the fields for dot-quad numbers less than 100. For example, if your IP address is 172.19.201.28, do not enter 028 for the last segment. Note: Configurations with the same IP subnet on multiple interfaces (Ethernet or PPP) are not currently supported.
Subnet Mask	The subnet mask specifies the network segment on which the SLB branch office manager resides. There is no default. If you selected DHCP or BOOTP, this prompt does not display.
Default Gateway	IP address of the router for this network. There is no default.
Hostname	The default host name is slbXXXX, where XXXX is the last 4 characters of the hardware address of Ethernet Port 1. There is a 64-character limit (contiguous characters, no spaces). Note: The host name becomes the prompt in the command line interface.
Domain	If desired, specify a domain name (for example, support.lantronix.com). The domain name is used for host name resolution within the SLB. For example, if abcd is specified for the SMTP server, and mydomain.com is specified for the domain, if abcd cannot be resolved, the SLB branch office manager attempts to resolve abcd.mydomain.com for the SMTP server.
Time Zone	If the time zone displayed is incorrect, enter the correct time zone and press Enter . If the entry is not a valid time zone, the system guides you through selecting a time zone. A list of valid regions and countries displays. At the prompts, enter the correct region and country.
Date/Time	If the date and time displayed are correct, type n and continue. If the date and time are incorrect, type y and enter the correct date and time in the formats shown at the prompts.
Sysadmin password	Enter a new sysadmin password.

After you complete the Quick Setup script, the changes take effect immediately.

Figure 4-7 Completed Quick Setup

Quick Setup will now step you through configuring a few basic settings.

The current settings are shown in brackets ('[]').

You can accept the current setting for each question by pressing <return>.

```
____ Ethernet Port and Default Gateway _____
```

The SLB88 has two ethernet ports, Eth1 and Eth2.

By default, both ports are configured for DHCP.

```
Configure Eth1:  (1) obtain IP Address from DHCP
                  (2) obtain IP Address from BOOTP
                  (3) static IP Address
```

```
Enter 1-3: [1]
```

The SLB88 can be configured to use a default gateway.

Enter gateway IP Address: [none]

_____Hostname_____

The current hostname is 'slb882/8824', and the current domain is '<undefined>'.

The hostname will be shown in the CLI prompt.

Specify a hostname: [slb882/8824]

Specify a domain: [<undefined>]

_____Time Zone_____

The current time zone is 'UTC'.

Enter time zone: [UTC]

_____Date/Time_____

The current time is Mon April 30 02:33:17 2018

Change the current time? [n]

_____Sysadmin Password_____

Enter new password: [<current password>]

Quick Setup is now complete.

Next Step

After completing quick setup on the SLB, you may want to configure other settings. You can use the web page or the command line interface for configuration.

- ◆ For information about the web and the command line interfaces, go to [Chapter 5: Web and Command Line Interfaces](#).
- ◆ To continue configuring the SLB, go to [Chapter 6: Basic Parameters](#).

5: Web and Command Line Interfaces

The SLB branch office manager offers three interfaces for configuring the SLB command line interface (CLI), a web interface, and an LCD with keypads on the front panel. This chapter discusses the web and command line interfaces. (*Chapter 4: Quick Setup on page 41* includes instructions for using the LCD to configure basic network settings.)

Web Interface

A web interface allows the system administrator and other authorized users to configure and manage the SLB unit using most web browsers (Firefox, Chrome or Internet Explorer with JavaScript enabled). The SLB branch office manager provides a secure, encrypted web interface over SSL (secure sockets layer).

Note: The web server listens for requests on the unencrypted (HTTP) port (port 80) and redirects all requests to the encrypted (HTTPS) port (port 443).

The following figure shows a typical web page:

Figure 5-1 Web Page Layout

The screenshot shows the LANTRONIX SLB882/8824 web interface. At the top, there is a navigation bar with tabs for Network, Services, User Authentication, Devices, Maintenance, and Quick Setup. The main content area is titled 'Network Settings' and contains several sections:

- Ethernet Interfaces:** This section contains two columns of settings for Eth1 and Eth2. Each column has radio buttons for 'Disabled', 'Obtain from DHCP', 'Obtain from BOOTP', and 'Specify'. Below these are input fields for IP Address, Subnet Mask, IPv6 Address, and IPv6 Address (Link Local). There are also dropdown menus for Mode and MTU, and input fields for HW Address and Multicast.
- Hostname & Name Servers:** This section has a text input field for Hostname (set to 'slbdb40') and a text input field for Domain. Below are three text input fields for DNS Servers labeled #1, #2, and #3.
- DHCP-Acquired DNS Servers:** This section has three text input fields for DNS Servers labeled #1, #2, and #3, all set to 'None'.
- GPRS-Acquired DNS Servers:** This section has three text input fields for DNS Servers labeled #1, #2, and #3, all set to 'None'.
- Gateway:** This section has a text input field for Default (set to '172.19.0.1') and a text input field for Alternate. Below are radio buttons for DHCP-Acquired and GPRS-Acquired, and a dropdown menu for Precedence. There are also input fields for IP Address to Ping, Ethernet Port for Ping (Eth1 or Eth2), Delay between Pings (set to '3' seconds), and Number of Failed Pings (set to '10').

A table at the bottom left shows network statistics:

	Rx				Tx			
	Bytes	Packets	Errors	Multicast	Bytes	Packets	Errors	
Eth1	2208529	21464	1	21100	234747	461	0	
Eth2	0	0	0	0	0	0	0	

At the bottom right, there is an 'Apply' button. The page also features a 'Logout Button' at the top left, a 'Port Number Bar' at the top right, and a 'Help Button' at the top right.

The web page has the following components:

- ◆ **Tabs:** Groups of settings to configure.
- ◆ **Options:** Below each tab are options for specific types of settings.

Note: Only those options for which the currently logged-in user has rights display.

- ◆ **Port and Power Outlet Bar:**

- ◆ The light green **LCD** button allows you to configure the front panel LCD
- ◆ The gray **U1** button allows you to configure the USB device (flash drive or modem) plugged into the front panel USB connector. The gray **U2** button allows you to configure the internal USB dial-up modem.
- ◆ The blue **E1** and **E2** buttons display the [Network > Network Settings \(bottom of page\)](#) page.
- ◆ The eight green number buttons allow you to select a port and display its settings. Only ports to which the currently logged-in user has rights are enabled.

Below the bar are three options for use with the port buttons. Selecting a port and the **Configuration** option takes you to the [Device Ports > Settings](#) page. Selecting a port and the **WebSSH** option displays the WebSSH window for the device port if Web SSH is enabled, and if SSH is enabled for the device port. Selecting the port and the **Connected Device** button allows access to supported devices such as SLP power managers and/or SensorSoft temperature and humidity probes connected to the device port.

- ◆ The red **P1 - P8** buttons enable you to select a power outlet and display the [Devices > Power Outlets](#) page with the selected outlet's information highlighted.
- ◆ The yellow **A** and **B** buttons display the status of the power supplies.
- ◆ **Entry Fields and Options:** Allow you to enter data and select options for the settings.

Note: For specific instructions on completing the fields on the web pages, see Chapters 5 through 12.

- ◆ **Apply Button:** Apply on each web page makes the changes immediately and saves them so they will be there when the SLB branch office manager is rebooted.
- ◆ **Icons:** The icon bar above the Main Menu has icons that display the following:

 Home page.

 Information about the SLB unit and Lantronix contact information.

 Configuration site map.

 Status of the SLB device.

- ◆ **Help Button:** Provides online Help for the specific web page.

Logging in

Only the system administrator or users with web access rights can log into the web page. More than one user at a time can log in, but the same user cannot login more than once.

To log in to the SLB web interface:

1. Open a web browser.
2. In the URL field, type `https://` followed by the IP address of your SLB branch office manager.
3. To configure the SLB unit, use `sysadmin` as the user name and `PASS` as the password. (These are the default values.)

Note: The system administrator may have changed the password using one of the Quick Setup methods in the previous chapter.

The Lantronix SLB [Quick Setup](#) page displays automatically the first time you log in. Subsequently, the Lantronix SLB Home page displays. (If you want to display the [Quick Setup](#) page again, click **Quick Setup** on the main menu.)

Logging Out

To log off the SLB web interface:

1. Click the **Logout** button located on the upper left part of any user interface page. You are brought back to the login screen when logout is complete.

Web Page Help

To view detailed information about an SLB web page:

1. Click the **Help** button to the right of any user interface page. Online Help contents will appear in a new browser.

Command Line Interface

A command line interface (CLI) is available for entering all the commands you can use with the SLB. In this User Guide, after each section of instructions for using the web interface, you will find the equivalent CLI commands. You can access the command line interface using Telnet, SSH, or a serial terminal connection.

Note: By default, Telnet is disabled and SSH is enabled. To enable Telnet, use the [Services > SSH/Telnet/Logging](#) web page, a serial terminal connection, or an SSH connection. (See [Chapter 7: Services](#).)

The `sysadmin` user and users with who have full administrative rights have access to the complete command set, while all other users have access to a reduced command set based on their permissions.

Logging In

To log in to the SLB command line interface:

1. Do one of the following:
 - ◆ With a serial terminal connection, power up, and when the command line displays, press **Enter**.

- ◆ If the SLB branch office manager already has an IP address (assigned previously or assigned by DHCP), Telnet (if Telnet has been enabled) or SSH to `xx.xx.xx.xx` (the IP address in dot quad notation) and press **Enter**. The login prompt displays.
2. To log in as the system administrator for setup and configuration, enter `sysadmin` as the user name and press **Enter**.
 3. Enter `PASS` as the password and press **Enter**. The first time you log in, the Quick Setup script runs automatically. Normally, the command prompt displays. (If you want to display the Quick Setup script again, use the `admin quicksetup` command.)

Note: The system administrator may have changed the password using one of the Quick Setup methods in the previous chapter.

To log in any other user:

1. Enter your SLB user name and press **Enter**.
2. Enter your SLB password and press **Enter**.

Logging Out

To log out of the SLB command line interface, type `logout` and press **Enter**.

Command Syntax

Commands have the following format:

```
<action> <category> <parameter(s)>
```

where

`<action>` is `set`, `show`, `connect`, `admin`, `diag`, or `logout`.

`<category>` is a group of related parameters whose settings you want to configure or view. Examples are `ntp`, `deviceport`, and `network`.

`<parameter(s)>` is one or more name-value pairs in one of the following formats:

<code><parameter name> <aa bb></code>	User must specify one of the values (aa or bb) separated by a vertical line (). The values are in all lowercase and must be entered exactly as shown. Bold indicates a default value.
<code><parameter name> <Value></code>	User must specify an appropriate value, for example, an IP address. The parameter values are in mixed case. Square brackets [] indicate optional parameters.

Table 5-2 Actions and Category Options

Action	Category
set	auth cflow cifs cli command consoleport datetime deviceport groups history hostlist ipfilter kerberos ldap localusers log menu network nfs nis ntp password perfmon power radius remoteusers routing script services site slcnetwork sshkey tacacs+ temperature usb vpn

Action	Category
show	auth auditlog cflow cifs cli connections consoleport datetime deviceport emaillog groups history hostlist ipfilter kerberos ldap localusers log menu network nfs nis ntp perfmon portcounters portstatus power radius remoteusers routing script services site slcnetwork sshkey sysconfig syslog sysstatus tacacs+ temperature usb user vpn
connect	bidirection direct global listen restart script terminate unidirection
diag	arp internals lookup loopback netstat nettrace perfstat ping ping6 sendpacket traceroute
admin	banner clear config events firmware ftp keypad lcd memory quicksetup reboot shutdown site version web
logout	Terminates CLI session.

Command Line Help

- ◆ For general Help and to display the commands to which you have rights, type: `help`
- ◆ For general command line Help, type: `help command line`
- ◆ For more information about a specific command, type `help` followed by the command. For example: `help set network` or `help admin firmware`

Tips

- ◆ Type enough characters to identify the action, category, or parameter name uniquely. For parameter values, type the entire value. For example, you can shorten:

```
set network port 1 state static ipaddr 122.3.10.1 mask 255.255.0.0
```

 to

```
se net po 1 st static ip 122.3.10.1 ma 255.255.0.0
```
- ◆ Use the Tab key to automatically complete action, category, or parameter names. Type a partial name and press **Tab** either to complete the name if only one is possible, or to display the possible names if more than one is possible. Following a space after the preceding name, Tab displays all possible names.
- ◆ Should you make a mistake while typing, backspace by pressing the Backspace key and/or the Delete key, depending on how you accessed the interface. Both keys work if you use VT100 emulation in your terminal access program when connecting to the console port. Use the left and right arrow keys to move within a command.
- ◆ Use the up and down arrows to scroll through previously entered commands. If desired, select one and edit it. You can scroll through up to 100 previous commands entered in the session.
- ◆ To clear an IP address, type 0.0.0.0, or to clear a non-IP address value, type `CLEAR`.
- ◆ When the number of lines displayed by a command exceeds the size of the window (the default is 25), the command output is halted until the user is ready to continue. To display the next line, press **Enter**, and to display the page, press the space bar. You can override the number of lines (or disable the feature altogether) with the `set cli` command.

General CLI Commands

The following commands relate to the CLI itself.

To configure the current command line session:

```
set cli scscommands <enable|disable>
```

Allows you to use SCS-compatible commands as shortcuts for executing commands:

Note: Settings are retained between CLI sessions for local users and users listed in the remote users list.

SCS Commands	SLB Commands
info	'show sysstatus'
version	'admin version'
reboot	'admin reboot'
poweroff	'admin shutdown'
listdev	'show deviceport names'
direct	'connect direct deviceport'
listen	'connect listen deviceport'
clear	'set locallog clear'
telnet	'connect direct telnet'
ssh	'connect direct ssh'

To set the number of lines displayed by a command:

```
set cli terminallines <disable|Number of lines>
```

Sets the number of lines in the terminal emulation (screen) for paging through text one screenful at a time, if the SLB branch office manager cannot detect the size of the terminal automatically.

To show current CLI settings:

```
show cli
```

To view the last 100 commands entered in the session:

```
show history
```

To clear the command history:

```
set history clear
```

To view the rights of the currently logged-in user:

```
show user
```

Note: For information about user rights, see [Chapter 11: User Authentication](#).

6: Basic Parameters

This chapter explains how to set the following basic configuration settings for the SLB branch office manager using the SLB web interface or the CLI:

- ◆ Network parameters that determine how the SLB branch office manager interacts with the attached network
- ◆ Firewall and routing
- ◆ Date and time

Note: If you entered some of these settings using a Quick Setup procedure, you may update them here.

Requirements

If you assign a different IP address from the current one, it must be within a valid range, unique to your network, and with the same subnet mask as your workstation.

To configure the unit, you need the following information:

Eth1 IP address: _____ - _____ - _____ - _____
Subnet mask: _____ - _____ - _____ - _____

Eth2 IP address (optional): _____ - _____ - _____ - _____
Subnet mask (optional): _____ - _____ - _____ - _____

Gateway: _____ - _____ - _____ - _____

DNS: _____ - _____ - _____ - _____

To enter settings for one or both network ports:

1. Click the **Network** tab and select the **Network Settings** option. The following page displays:

Figure 6-1 Network > Network Settings (top of page)

LANTRONIX® SLB882/8824

LCD
U1
E1
1
2
3
4
P1
P2
P3
P4
P5
P6
P7
P8
A
B

Logout

Host: slb2056
User: sysadmin

Select port for:
 Configuration
 WebSSH (DP only)
 Connected Device (DP only)

Network

Services

User Authentication

Devices

Maintenance

Quick Setup

[Home](#)
[?](#)
[Refresh](#)

Network Settings
 [IP Filter](#)
[Routing](#)
[VPN](#)
[Perf Monitoring](#)

Help ?

Network Settings

Ethernet Interfaces

Disabled

Eth1 Settings:

Obtain from DHCP

Obtain from BOOTP

Specify:

IP Address:

Subnet Mask:

IPv6 Address (Static):

IPv6 Address (Link Local):

Mode:

MTU:

HW Address: **00:80:a3:c3:20:56**

Multicast: **239.255.255.251**
224.0.0.1

Enable IPv6: (Requires reboot)

Disabled

Eth2 Settings:

Obtain from DHCP

Obtain from BOOTP

Specify:

IP Address:

Subnet Mask:

IPv6 Address (Static):

IPv6 Address (Link Local):

Mode:

MTU:

HW Address: **00:80:a3:c3:20:57**

Multicast: **224.0.0.1**

Ethernet Bonding:

[Ethernet Bonding Status >](#)

	Rx				Tx		
	Bytes	Packets	Errors	Multicast	Bytes	Packets	Errors
Eth1	1346138	8938	5	7833	425345	1185	1
Eth2	0	0	0	0	0	0	0

Hostname & Name Servers

Hostname:

Note: The hostname will be used as the prompt in the Command Line Interface.

Domain:

DNS Servers

#1:

#2:

#3:

DHCP-Acquired DNS Servers

#1: **None**

#2: **None**

#3: **None**

GPRS-Acquired DNS Servers

#1: **None**

#2: **None**

#3: **None**

Enable IP Forwarding:

TCP Keepalive Parameters

Start Probes: secs

Number of Probes:

Interval: secs

Gateway

Default:

DHCP-Acquired: **none**

GPRS-Acquired: **none**

Precedence:
 DHCP-Acquired
 Default
 GPRS-Acquired

Fail-Over Settings

Fail-over Gateway IP Address:

IP Address to Ping to Trigger Fail-Over:

Ethernet Port for Ping: Eth1 Eth2

Delay between Pings: seconds

Number of Failed Pings:

SLB™ Branch Office Manager User Guide

59

Figure 6-2 Network > Network Settings (bottom of page)

Fail-Over Cellular Gateway Configuration

Fail-over Device:

APN of Mobile Carrier:

Admin Login:

Admin Password:

Change Admin Password:

New Admin Password: Retype:

Reboot Gateway When Making Changes:

Advanced Cellular Gateway Configuration

SIM Card PIN Lock:

PIN # for SIM Card: Retype:

SIM PUK: Retype:

The fail-over gateway is used if an IP address accessible through the default gateway fails to return one or more pings.

[Fail-Over Cellular Gateway Status >](#)

Fail-Over Cellular Gateway Firmware

Update Firmware:

Functional Firmware Filename: [Upload File >](#)

Radio Firmware Filename: [Upload File >](#)

Load Firmware via:

Load Cellular Gateway Firmware Options

FTP/SFTP/SCP Server:

Path:

Login:

Password:

Retype Password:

2. Enter the following information:

Eth1 and Eth2 Settings

Note: Configurations with the same IP subnet on multiple interfaces (Ethernet or PPP) are not currently supported.

<p>Eth1 Settings or Eth2 Settings</p>	<ul style="list-style-type: none"> ◆ Disabled: If selected, disables the network port. ◆ Obtain from DHCP: Acquires IP address, subnet mask, hostname and gateway from the DHCP server. (The DHCP server may not provide the hostname gateway, depending on its setup.) This is the default setting. If you select this option, skip to Gateway. ◆ Obtain from BOOTP: Lets a network node request configuration information from a BOOTP "server" node. If you select this option, skip to Gateway. ◆ Specify: Lets you manually assign a static IP address, generally provided by the system administrator.
<p>IP Address (if specifying)</p>	<ul style="list-style-type: none"> ◆ Enter an IP address that will be unique and valid on your network. There is no default. ◆ Enter all IP addresses in dot-quad notation. Do not use leading zeros in the fields for dot-quad numbers less than 100. For example, if your IP address is 172.19.201.28, do not enter 028 for the last segment. <p>Note: Currently, the SLB branch office manager does not support configurations with the same IP subnet on multiple interfaces (Ethernet or PPP).</p>
<p>Subnet Mask</p>	<p>If specifying an IP address, enter the network segment on which the SLB unit resides. There is no default.</p>

IPv6 Address	<p>Address of the port in IPv6 format.</p> <p>Note: The SLB branch office manager supports IPv6 connections for a limited set of services: the web, SSH, and Telnet.</p> <p>IPv6 addresses are written as 8 sets of 4-digit hexadecimal numbers separated by colons. There are several rules for modifying the address. For example: 1234 : 0BCD : 1D67 : 0000 : 0000 : 8375 : BADD : 0057 may be shortened to 1234 : BCD : 1D67 : : 8375 : BADD : 57 .</p>
IPv6 Address (Link Local)	An IPv6 address that is intended only for communications within the segment of a local network.
Mode	Select the direction (full duplex or half-duplex) and speed (10 or 100Mbit) of data transmission. The default is Auto, which allows the Ethernet port to auto-negotiate the speed and duplex with the hardware endpoint to which it is connected.
MTU	Displays the multicast address of the Ethernet port.
Enable IPv6	Select this box to enable the IPv6 protocol. Disabled by default.
Ethernet Bonding	Ethernet 1 and Ethernet 2 can be bonded to support redundancy (Active Backup), aggregation (802.3ad), and load balancing. Disabled by default. Note that if Ethernet Bonding is enabled, assigning individual IP Addresses to Device Ports is not supported.
Enable IP Forwarding	<p>IP forwarding enables network traffic received on one interface (Eth1, Eth2, or an external/USB modem attached to the SLB branch office manager with an active PPP connection) to be transferred out another interface (any of the above). The default behavior (if IP forwarding is disabled) is for network traffic to be received but not routed to another destination.</p> <p>Enabling IP forwarding is required if you enable Network Address Translation (NAT) for any device port modem or USB/ISDN modem. IP forwarding allows a user accessing the SLB unit over a modem to access the network connected to Eth1 or Eth2.</p>

Note: Configurations with the same IP subnet on multiple interfaces (Ethernet or PPP) are not currently supported.

Hostname & Name Servers

Hostname	The default host name is slbXXXX, where XXXX is the last 4 characters of the hardware address of Ethernet Port 1. There is a 64-character limit (contiguous characters, no spaces). The host name becomes the prompt in the command line interface.
Domain	If desired, specify a domain name (for example, support.lantronix.com). The domain name is used for host name resolution within the SLB. For example, if abcd is specified for the SMTP server, and mydomain.com is specified for the domain, if abcd cannot be resolved, the SLB branch office manager attempts to resolve abcd.mydomain.com for the SMTP server.

DNS Servers

DNS Servers #1 - #3	<p>Configure up to three name servers. #1 is required if you choose to configure DNS (Domain Name Server) servers.</p> <p>The first three DNS servers acquired via DHCP through Eth1 and/or Eth2 display automatically.</p>
----------------------------	---

DHCP-Acquired DNS Servers

#1 - #3	Displays the IP address of the name servers if automatically assigned by DHCP.
---------	--

GPRS-Acquired DNS Servers

#1 - #3	Displays the IP address of the name servers if automatically assigned by General Packet Radio Service (GPRS).
---------	---

TCP Keepalive Parameters

Start Probes	Number of seconds the SLB branch office manager waits after the last transmission before sending the first probe to determine whether a TCP session is still alive. The default is 600 seconds (10 minutes).
Number of Probes	Number of probes the SLB unit sends before closing a session. The default is 5.
Interval	The number of seconds the SLB device waits between probes. The default is 60 seconds.

Gateway

Default	<p>IP address of the router for this network.</p> <p>If this has not been set manually, any gateway acquired by DHCP for Eth1 or Eth2 displays.</p> <p>All network traffic that matches the Eth1 IP address and subnet mask is sent out Eth1. All network traffic that matches the Eth2 IP address and subnet mask is sent out Eth 2.</p> <p>If you set a default gateway, any network traffic that does not match Eth1 or Eth2 is sent to the default gateway for routing.</p>
DHCP-Acquired	Gateway acquired by DHCP for Eth1 or Eth2. View only.
GPRS-Acquired	Displays the IP address of the router if it has been automatically assigned by General Packet Radio Service (GPRS). View only.
Precedence	Indicates whether the gateway acquired by DHCP or the default gateway takes precedence. The default is DHCP Gateway. If the DHCP Gateway is selected and both Eth1 and Eth2 are configured for DHCP, the SLB unit gives precedence to the Eth1 gateway.
Enable IP Forwarding	<p>IP forwarding enables network traffic received on one interface (Eth1, Eth2, or an external/USB modem attached to the SLB branch office manager with an active PPP connection) to be transferred out another interface (any of the above). The default behavior (if IP forwarding is disabled) is for network traffic to be received but not routed to another destination.</p> <p>Enabling IP forwarding is required if you enable Network Address Translation (NAT) for any device port modem or USB/ISDN modem. IP forwarding allows a user accessing the SLB unit over a modem to access the network connected to Eth1 or Eth2.</p>

Fail-Over Settings

Fail-Over Gateway IP Address	<p>An alternate IP address of the router for this network, to be used if an IP address usually accessible through the default gateway fails to return one or more pings.</p> <p>Note: The fail-over gateway is not supported when DHCP is used.</p>
IP Address to Ping	IP address to ping to determine whether to use the fail-over gateway.

Ethernet Port to Ping	Ethernet port to use for the ping.
Delay between Pings	Number of seconds between pings.
Number of Failed Pings	Number of pings that fail before the SLB branch office manager uses the fail-over gateway.

Fail-Over Cellular Gateway Configuration

Fail-over Device	<p>Select an integrated device to be used as the fail-over gateway. Currently the Sierra Wireless AirLink ES450 is supported.</p> <p>The Sierra gateway must be properly provisioned before first use by initializing the APN of the installed SIM card. This is done by connecting the Sierra gateway to the second ethernet port of the SLB, and assigning a static IP address to the SLB port so that it is in the same subnet as the IP address of the Sierra gateway. Use the console CLI or web GUI to set the APN of the SIM card. After setting the APN, power cycle the Sierra gateway and allow it to reboot completely.</p> <p>The failover feature requires that both Ethernet ports be configured with a static IP address. Using DHCP on one of the Ethernet ports may overwrite the default route, interfering with fail-over and fail-back.</p> <p>Note: <i>The commands sent to the fail-over device to retrieve status and update the configuration are shown in the syslog (messages may be displayed under Network syslog; at the Debug level). If there are errors retrieving status or updating the configuration, check messages in the Network syslog, the device administrator login/password, connectivity to the device and the firmware version of the fail-over device (the minimum required firmware version for Sierra Wireless ES450 is 4.9.2).</i></p> <p>When the SLB sends an updated configuration to the fail-over device, it is recommended to check the SLB syslog, even if the SLB indicates that the update was successful. Responses from the fail-over device indicating that the device needs to be rebooted for configuration changes to take effect may also be in the syslog. The configuration will be resent to the device if any of the fail-over device settings are changed, or the selected fail-over device is changed from None to one of the supported fail-over device types.</p> <p>When a fail-over or fail-back occurs, running applications such as VPN tunnel and ConsoleFlow will be restarted.</p>
APN of Mobile Carrier	For the Sierra gateways, configure the Access Point Name for the mobile carrier. May have up to 80 characters.
Admin Login and Password/Retype	For the selected Fail-over Device , the administrator login and password used to retrieve status from the device and send configuration updates to the device. The login may have up to 32 characters, and the password may have up to 64 characters. The Sierra gateway login must be set as 'user'.
Change Admin Password (check box)	Select this check box if you wish to update the admin password for the selected gateway Fail-over Device .
New Admin Password/Retype	For the selected Fail-over Device , the administrator password can be changed on the gateway. The password may have up to 64 characters.
Reboot Gateway When Making Changes (check box)	The administrator can reboot the gateway.
Fail-Over Cellular Gateway Status (link)	<p>Clicking the link opens the Fail-Over Cellular Gateway status window, showing status and statistics about the fail-over gateway.</p> <p>Click Back to Network Settings to return to the Network Settings page.</p>

Advanced Cellular Gateway Configuration

PIN Lock (check box)	For the Sierra gateways, enable a lock so that the SIM card used by the gateway cannot be used by anyone who does not have the PIN.
Pin # for SIM Card/Retype	For the Sierra gateways, the PIN number for the SIM card used by the gateway. May have up to 8 characters.
SIM PUK/Retype	The Sierra gateway does not have this feature.

Fail-Over Cellular Gateway Firmware

Note: The Sierra fail-over device must be selected in order for you to be able to update the firmware.

Update Firmware (check box)	Select this option to update firmware on the Sierra gateway. The Functional Firmware file and the Radio Firmware file will be transferred to the SLB using the method selected by the Load Firmware via option. Once the files have been transferred to the SLB, the SLB will initiate the firmware update on the Sierra gateway.
Firmware Filename	Enter the name of the firmware filename exactly as it is represented.
Radio Firmware Filename	Enter the name of the radio firmware filename exactly as it is represented.
Load Firmware via	Select the method to load the firmware from the options in the drop-down menu.

Load Cellular Gateway Firmware Options

FTP/SFTP/SCP Server	Enter the server address from where to load the firmware.
Path	Enter the server directory pathway to the files.
Login	Enter the user login for the FTP/SFTP/SCP server to verify access rights to load new firmware.
Password/Retype Password	Enter the password for the FTP/SFTP/SCP server to verify access rights to load new firmware. Retype the password in the Retype Password field.

- To save your entries, click the **Apply** button. **Apply** makes the changes immediately and saves them so they will be there when the SLB branch office manager is rebooted.

Ethernet Counters

The [Network > Network Settings \(bottom of page\)](#) page displays statistics for each of the SLB's Ethernet ports since boot-up. The system automatically updates them.

Note: For Ethernet statistics for a smaller time period, use the `diag perfstat command`.

Network Commands

Go to [Network Commands \(on page 307\)](#) to view CLI commands which correspond to the web page entries described above.

IP Filter

IP filters (also called a rule set) act as a firewall to allow or deny individual or a range of IP addresses, ports, and protocols. When a network connection is configured to use an IP filter, all network traffic through that connection is compared, in order, to the rules of that filter. Network traffic may be allowed to pass, it may be dropped (without notice), or it may be rejected (sends back an error packet) depending upon the rules of that filter rule set.

The administrator uses the [Network > IP Filter](#) page to view, add, edit, delete, and map IP filters,

Warning: *IP filters configuration is a feature for advanced users. Adding and enabling IP filter sets incorrectly can disable your SLB.*

Viewing IP Filters

You can view a list of filters and a table showing how each filter is mapped to an interface.

To view a list of IP filters:

1. Click the **Network** tab and select the **IP Filter** option. The following page displays:

Figure 6-3 Network > IP Filter

The screenshot displays the LANTRONIX SLB882/8824 web interface. At the top, there is a navigation bar with tabs for Network, Services, User Authentication, Devices, Maintenance, and Quick Setup. The 'IP Filter' tab is selected. Below the navigation bar, the page title is 'IP Filter' with a 'Help?' link. The main content area includes:

- An 'Enable IP Filter' checkbox, which is currently unchecked.
- A link to 'IP Filter Status'.
- Statistics: 'Packets Dropped: 0' and 'Packets Rejected: 0'.
- 'Test Timer' settings: 'No' (selected) or 'Yes, minutes (1-120):' with an input field. Below this is 'Time Remaining: 0 minutes'.
- A note: 'Use the Test Timer to verify the IP Filter Rulesets; IP Filter will automatically be disabled when the Test Timer expires.'
- Buttons for 'Add Ruleset', 'Edit Ruleset', and 'Delete Ruleset'.
- 'Map Ruleset' to Interface: 'Ethernet 1' (selected in a dropdown) with a 'Delete Mapping' button.
- Two tables:

IP Filter Rulesets	
Name	

IP Filter Mappings	
Interface	Ruleset
- An 'Apply' button at the bottom.

Enabling IP Filters

On the [Network > IP Filter](#) page, you can enable all filters or disable all filters.

Note: *There is no way to enable or disable individual filters.*

To enable IP filters:

1. Enter the following:

Enable IP Filter	Select the Enable IP Filter checkbox to enable all filters, or clear the checkbox to disable all filters. Disabled by default.
Packets Dropped	Displays the number of data packets that the filter ignored (did not respond to). View only.
Packets Rejected	Displays the number of data packets that the filter sent a “rejected” response to. View only.
Test Timer	Timer for testing IP Filter rulesets. Select No to disable the timer. Select Yes, minutes (1-120) to enable the timer and enter the number of minutes the timer should run. The timer automatically disables the IP Filters when the time expires.
Time Remaining	Indicates how many minutes are left on the timer before it expires and IP Filters disabled. View only.

Configuring IP Filters

The administrator can add, edit, delete, and map IP filters.

Note: A configured filter has no effect until it is mapped to a network interface. See [Mapping a Ruleset on page 69](#).

To add an IP filter:

1. On the [Network > IP Filter](#) page, click the **Add Ruleset** button. The following page displays:

Figure 6-4 Network > IP Filter Ruleset (Adding/Editing Rulesets)

LANTRONIX[®] SLB882/8824

Logout Host: slb2056 User: sysadmin Select port for Configuration WebSSH (DP only) Connected Device (DP only)

Network Services User Authentication Devices Maintenance Quick Setup

Network Settings IP Filter Routing VPN Perf Monitoring

Network - IP Filter Ruleset Help ?

Ruleset Name: Number of Rules: 1

Rule Parameters

IP Address(es):

Subnet Mask:

Protocol: All

Port Range:

Action: Drop Reject Accept

Rules (in order of precedence)

0.0.0.0/0;All;;Drop

Generate rule to allow service:

- BOOTP/DHCP
- Telnet
- HTTP
- FTP
- DNS
- SNMP
- NIS
- SFTP
- RIP
- SMTP
- LDAP
- TFTP
- NTP
- NFS
- RADIUS
- VPN
- Syslog
- SMB/CIFS
- Kerberos
- LDP
- SSH
- HTTPS
- TACACS+
- SLB Logging

[Back to IP Filter](#)

Rulesets can be added or updated on this page.





2. Enter the following:

Ruleset Name	Name that identifies a filter; may be composed of letters, numbers, and hyphens only. (The name cannot start with a hyphen.) Example: FILTER-2
---------------------	---

Rule Parameters

IP Address(es)	Specify a single IP address to act as a filter. Example: 172.19.220.64 – this specific IP address only
Subnet Mask	Specify a subnet mask to act determine how much of the address should apply to the filter. Example: 255.255.255.255 to specify the whole address should apply.
Protocol	From the drop-down list, select the type of protocol through which the filter will operate. The default setting is All.

Port Range	<p>Enter a range of destination TCP or UDP port numbers to be tested. An entry is required for TCP, TCP New, TCP Established, and UDP, and is not allowed for other protocols. Separate multiple ports with commas. Separate ranges of ports by colons.</p> <p>Examples:</p> <ul style="list-style-type: none"> ◆ 22 – filter on port 22 only ◆ 23,64,80 – filter on ports 23, 64 and 80 ◆ 23:64,80,143:150 – filter on ports 23 through 64, port 80 and ports 143 through 150
Action	<p>Select whether to Drop, Reject, or Accept communications for the specified IP address, subnet mask, protocol, and port range. Drop ignores the packet with no notification. Reject ignores the packet and sends back an error message. Allow permits the packet through the filter.</p>
Generate rule to allow service	<p>You may wish to “punch holes” in your filter set for a particular protocol or service. For instance, if you have configured your NIS server and wish to create an opening in your filter set, select the NIS option and click the Add Rule button. This entry adds a new rule to your filter set using the NIS -configured IP address. Other services and protocols added automatically generate the necessary rule to allow their use.</p>

3. Click the right arrow  button to add the new rule to the bottom of the Rules list box on the right. A maximum of 64 rules can be created for each ruleset.
4. To remove a rule from the filter set, highlight that line and click the left  arrow. The rule populates the rule definition fields, allowing you to make minor changes before reinserting the rule. To clear the definition fields, click the **Clear** button.
5. To change the order of priority of the rules in the list box, select the rule to move and use the up  or down  arrow buttons on the right side of the filter list box.
6. To save, click the **Apply** button. The new filter displays in the menu tree.

Note: To add another new filter rule set, click the **Back to IP Filter** link to return to the [Network > IP Filter](#) page.

Updating an IP Filter

To update an IP filter rule set:

1. From the [Network > IP Filter](#) page, the administrator selects the IP filter ruleset to be edited and clicks the **Edit Ruleset** button to return to the [Network > IP Filter Ruleset \(Adding/Editing Rulesets\)](#) page (see [Figure 6-4](#)).
2. Edit the information as desired and click the **Apply** button.

Deleting an IP Filter

To delete an IP filter rule set:

1. On the [Network > IP Filter](#) page, the administrator selects the IP filter ruleset to be deleted and clicks the **Delete Ruleset** button.

Mapping a Ruleset

The administrator can assign an IP Filter Ruleset to a network interface (Ethernet interface) and a modem connected to a Device Port.

To map a rule set to a network interface:

1. On the [Network > IP Filter](#) page, select the IP filter ruleset to be mapped.
2. From the Interface drop-down list, select the interface and click the **Map Ruleset** button. The Interface and rule set display in the IP Filter Mappings table.

To delete a mapping:

- 1) On the [Network > IP Filter](#) page, select the mapping from the list and click the **Delete Mapping** button. The mapping no longer displays.
- 2) Click the **Apply** button.

IP Filter Commands

Go to [IP Filter Commands \(on page 303\)](#) to view CLI commands which correspond to the web page entries described above

Routing

The SLB branch office manager allows you to define static routes and, for networks using Routing Information Protocol (RIP)-capable routes, to enable the RIP protocol to configure the routes dynamically.

To configure routing settings:

1. Click the **Network** tab and select the **Routing** option. The following page displays:

Figure 6-5 Network > Routing

LANTRONIX[®] SLB882/8824

Logout Host: slb2056 User: sysadmin Select port for Configuration WebSSH (DP only) Connected Device (DP only)

Network Services User Authentication Devices Maintenance Quick Setup

Network Settings IP Filter Routing VPN Perf Monitoring

Routing Help?

Enable RIP: RIP Version: 1 2 1 and 2 The Routing Table can be viewed with the [IP Routes Report](#).

Enable Static Routing: To edit or delete a static route, select the radio button in the right column below.

IP Address:
 Subnet Mask:
 Gateway:

Add/Edit Route
 Delete Route

Apply

Static Routes			
No	IP Address	Subnet Mask	Gateway

2. Enter the following:

Dynamic Routing

Enable RIP	Select to enable Dynamic Routing Information Protocol (RIP) to assign routes automatically. Disabled by default.
RIP Version	Select the RIP version. The default is 2.

Static Routing

Enable Static Routing	<p>Select to assign the routes manually. The system administrator usually provides the routes. Disabled by default.</p> <ul style="list-style-type: none"> ◆ To add a static route, enter the IP Address, Subnet Mask, and Gateway for the route and click the Add/Edit Route button. The route displays in the Static Routes table. You can add up to 64 static routes. ◆ To edit a static route, select the radio button to the right of the route, change the IP Address, Subnet Mask, and Gateway fields as desired, and click the Add/Edit Route button. ◆ To delete a static route, select the radio button to the right of the route and click the Delete Route button.
------------------------------	--

3. Click the **Apply** button.

Note: To display the routing table, status or specific report, see the section, [Status/Reports on page 238](#).

Routing Commands

Go to [Routing Commands \(on page 318\)](#) to view CLI commands which correspond to the web page entries described above.

VPN

This page can be used to create a Virtual Private Network (VPN) tunnel to the SLB branch office manager for secure communication between the SLB device and a remote host or gateway. The SLB unit supports IPsec tunnels using Encapsulated Security Payload (ESP). The SLB branch office manager supports host-to-host, net-to-net, host-to-net, and roaming user tunnels.

Note: To allow VPN tunnel access if the SLB firewall is enabled, traffic to UDP ports 500 and 4500 from the remote host should be allowed, as well as protocol ESP from the remote host.

To complete the VPN page:

1. Click the **Network** tab and select the **VPN** option. The following page displays:

Figure 6-6 Network > VPN

LANTRONIX[®] SLB882/8824

Logout Host: slb2056 User: sysadmin

Select port for Configuration WebSSH (DP only) Connected Device (DP only)

Network Services User Authentication Devices Maintenance Quick Setup

Network Settings IP Filter Routing VPN Perf Monitoring

VPN Help?

Enable VPN Tunnel: Current VPN Tunnel Status: **Down**

Name:

Ethernet Port: 1 2

Remote Host:

Remote Id: [View Detailed Status >](#)

Remote Hop/Router: [View VPN Logs >](#)

Remote Subnet(s): [View SLB RSA Public Key >](#)

Local Id:

Local Hop/Router:

Local Subnet(s):

IKE Negotiation: Main Mode Aggressive Mode

IKE Encryption: Authentication: DH Group:

ESP Encryption: Authentication: DH Group:

Authentication: RSA Public Key Pre-Shared Key

RSA Public Key for Remote Host:

Pre-Shared Key: Retype Pre-Shared Key:

Perfect Forward Secrecy:

Mode Configuration Client:

XAUTH Client:

XAUTH Login:

XAUTH Password: Retype Password:

2. Enter the following:

Enable VPN Tunnel	Select to create a tunnel.
Name	The name assigned to the tunnel. Required to create a tunnel.
Ethernet Port	Select ethernet port 1 or 2.
Remote Host	The IP address of the remote host's public network interface. The special value of any can be entered if the remote host is a roaming user who may not have the same IP address each time a tunnel is created. In this case, it is recommended that the Remote Id also be configured.
Remote Id	How the remote host should be identified for authentication. The Id is used to select the proper credentials for communicating with the remote host.
Remote Hop/Router	If the remote host is behind a gateway, this specifies the IP address of the gateway's public network interface.
Remote Subnet(s)	One or more subnets behind the remote host, expressed in CIDR notation (IP address/mask bits). If multiple subnets are specified, the subnets should be separated by a comma.
Local Id	How the SLB branch office manager should be identified for authentication. The Id is used by the remote host to select the proper credentials for communicating with the SLB.
Local Hop/Router	If the SLB unit is behind a gateway, this specifies the IP address of the gateway's public network interface.
Local Subnet(s)	One or more subnets behind the SLB, expressed in CIDR notation (IP address/mask bits). If multiple subnets are specified, the subnets should be separated by a comma.
IKE Negotiation	The Internet Key Exchange (IKE) protocol is used to exchange security options between two hosts who want to communicate via IPSec. The first phase of the protocol authenticates the two hosts to each other and establishes the Internet Security Association Key Management Protocol Security Association (ISAKMP SA). The second phase of the protocol establishes the cryptographic parameters for protecting the data passed through the tunnel, which is the IPSec Security Association (IPSec SA). The IPSec SA can periodically be renegotiated to ensure security. The IKE protocol can use one of two modes: Main Mode, which provides identity protection and takes longer, or Aggressive Mode, which provides no identity protection but is quicker. With Aggressive Mode, there is no negotiation of which cryptographic parameters will be used; each side must give the correct cryptographic parameters in the initial package of the exchange, otherwise the exchange will fail. If Aggressive Mode is used, the IKE Encryption , IKE Authentication , and IKE DH Group must be specified.
IKE Encryption	The type of encryption, 3DES or AES , used for IKE negotiation. Any can be selected if the two sides can negotiate which type of encryption to use.
Authentication (Ike)	The type of authentication, SHA1 or MD5 , used for IKE negotiation. Any can be selected if the two sides can negotiate which type of authentication to use.
DH Group (Ike)	The Diffie-Hellman Group, 2 or 5 , used for IKE negotiation. Any can be selected if the two sides can negotiate which Diffie-Hellman Group to use.
ESP Encryption	The type of encryption, 3DES or AES , used for encrypting the data sent through the tunnel. Any can be selected if the two sides can negotiate which type of encryption to use.
Authentication (Ike)	The type of authentication, SHA1 or MD5 , used for authenticating data sent through the tunnel. Any can be selected if the two sides can negotiate which type of authentication to use.

DH Group (Ike)	The Diffie-Hellman Group, 2 or 5 , used for the key exchange for data sent through the tunnel. Any can be selected if the two sides can negotiate which Diffie-Hellman Group to use.
Authentication	The type of authentication used by the host on each side of the VPN tunnel to verify the identity of the other host. For RSA Public Key , each host generates a RSA public-private key pair, and shares its public key with the remote host. The RSA Public Key for the SLB branch office manager (which has 2192 bits) can be viewed at either the web or CLI. For Pre-Shared Key , each host enters the same passphrase to be used for authentication.
RSA Public Key for Remote Host	If RSA Public Key is selected for authentication, enter the public key for the remote host.
Pre-Shared Key	If Pre-Shared Key is selected for authentication, enter the key.
Retype Pre-Shared Key	If Pre-Shared Key is selected for authentication, re-enter the key.
Perfect Forward Secrecy	When a new IPsec SA is negotiated after the IPsec SA lifetime expires, a new Diffie-Hellman key exchange can be performed to generate a new session key to be used to encrypt the data being sent through the tunnel. If this is enabled, it provides greater security, since the old session keys are destroyed.
Mode Configuration Client	If this is enabled, the SLB unit can receive network configuration from the remote host. This allows the remote host to assign an IP address/netmask to the SLB device side of the VPN tunnel.
XAUTH Client	If this is enabled, the SLB branch office manager will send authentication credentials to the remote host if they are requested. XAUTH, or Extended Authentication, can be used as an additional security measure on top of the Pre-Shared Key or RSA Public Key.
XAUTH Login (Client)	If XAUTH Client is enabled, this is the login used for authentication.
XAUTH Password	If XAUTH Client is enabled, this is the password used for authentication.
Retype Password	If XAUTH Client is enabled, this is the password used for authentication.

3. To save, click **Apply** button.
4. To see a details of the VPN tunnel connection, including the cryptographic algorithms used, select the **View Detailed Status** link.
5. To see the last 100 lines of the logs associated with the VPN tunnel, select the **View VPN Logs** link.
6. To see the RSA public key for the SLB branch office manager (required for configuring the remote host if RSA Public Keys are being used), select the **View SLB RSA Public Key** link.

Performance Monitoring

The SLB supports Performance Monitoring probes for analyzing network performance. Probes for DNS Lookup, HTTP Get, ICMP Echo, TCP Connect, UDP Jitter and UDP Jitter VoIP are supported. Up to 15 different probes can be configured. Each probe will run a series of operations, each of which sends a series of packets to a destination host. The SLB will measure how long it took to receive a response, and record the results. For each operation, the user can view the results for each packet (round trip times), or the accumulated statistics for all packets - minimum, average and maximum latency, and for jitter probes, minimum, average, maximum and standard deviation of the jitter delay. Dropped packets and other error conditions are recorded for each operation. This capability allows an administrator to analyze network efficiency across the network.

An operation consists of sending a specified number of packets to a destination host and optional port, with a specified amount of time between each packet. All results for each operation are stored in one data file, and the results can be viewed later.

Repository and Operations Kept: The SLB can be configured to store probe results on the local SLB storage or an external USB thumb drive. The number of operations that can be stored per probe on the local SLB storage is 50 operations; for external USB thumb drive, 200 operations can be stored per probe.

Responders: The SLB can act as a responder for probes that require a responder to answer packets that are sent from the SLB (UDP jitter, UDP jitter VoIP, UDP Echo and TCP Connect). The SLB UDP jitter responder can support packet responses for up to 15 UDP jitter or UDP jitter VoIP probes. The UDP Echo and TCP Connect can support packets responses for one UDP Echo or TCP Connect probe.

Jitter Probes and Clock Skew: For jitter probes, it is important to have both the sender and responder synchronized to a reliable NTP server. Significant clock skew can greatly affect jitter results, as timestamps are recorded in the sender probe and the responder, and these timestamps are used to measure one-way latency for the packets. At the start of each jitter operation, the clock skew between the sender and the responder will be output to the system log.

Compatibility with Cisco Responders: The SLB Performance Monitor sender is compatible with Cisco IP SLA responders (IOS versions 12.2 and 15.0) for jitter probes. The SLB uses a simplified version of the IP SLA v2 (Engine II) protocol to communicate with the Cisco IP SLA responders. This compatibility gives the administrator a large number of devices with which to measure network performance.

To manage or view status for a Performance Monitoring probe:

1. Click the **Network** tab and select the **Perf Monitoring** option. The following page displays.

Figure 6-7 Network > Perf Monitoring

LANTRONIX[®] SLB882/8824

Logout Host: slb2056 User: sysadmin

Select port for Configuration WebSSH (DP only) Connected Device (DP only)

Network Services User Authentication Devices Maintenance Quick Setup

Network Settings IP Filter Routing VPN Perf Monitoring

Performance Monitoring Help?

Number of operations kept for each probe: UDP Jitter Responder:

Repository for operations: UDP Echo Responder: UDP Port:

TCP Connect Responder: TCP Port:

[Refresh](#) [Add Probe](#) [Operations](#) [Latest RTT Results](#) [Latest Accumulated Statistics](#)

0 probes(s)							State:	<input type="button" value="Restart"/>	<input type="button" value="Edit Probe"/>	<input type="button" value="Delete Probe"/>
Id	Name	State	Start Time First Op	Finish Time Last Op	Error	Operations Comp/Total				

2. In the upper section of the page, modify the global Performance Monitoring settings:

Number of operations kept for each probe	Specifies the number of operation set files to keep for each probe. The limit for Local storage is 50 sets. The limit for external USB is 200 sets. While a probe is running, the operation set files will be automatically culled to remove the oldest operation set files.
Repository for operations	The repository where the operation set files will be kept - Local storage, or a USB thumb drive inserted in the upper USB Port U1 . The data is stored in individual directories under a directory called "perfmon". Once probes have been run and operation set files have been generated, changing the repository will cause all of the existing files to be moved from the old repository directory to the new repository directory. It is recommended that the repository only be changed when probes are not actively running. If external storage is used for the repository, it is recommended that the external storage device not be removed from the SLB while probes are actively running.
UDP Jitter Responder	Starts the UDP Jitter responder to reply to UDP jitter or UDP jitter VoIP packets. The responder will listen on UDP port 1967 for control messages requesting to start individual responders on a specific UDP port. The SLB UDP jitter responder can support up to 15 UDP jitter senders.
UDP Echo Responder	Starts the UDP Echo responder on the port configured in UDP Port to reply to UDP echo packets. The SLB UDP Echo responder supports one UDP echo sender. When the UDP Echo responder is enabled, the SLB will verify that the responder UDP port is not being used by any other SLB processes, including port 1967 which is reserved for the UDP Jitter responder.

TCP Connect Responder	<p>Starts the TCP Connect responder on the port configured in TCP Port to reply to TCP connect requests. The SLB TCP Connect responder supports one TCP connect sender.</p> <p>When the TCP Connect responder is enabled, the SLB will verify that the responder TCP port is not being used by any other SLB processes.</p>
-----------------------	--

- Click the **Apply** button.
- In the lower section of the page, select a probe by clicking the radio button to the far right in the probe's row. The options that are available for that probe will be ungreyed. Select one of the following options:

Refresh	Refreshes the information on the Performance Monitoring page.
Add Probe	Displays the Performance Monitoring - Add/Edit Probe web page to add a new probe.
Operations	Displays a list of completed operations for the selected probe and allows the user to view either raw packet results or accumulated statistics for any operation.
Latest Results	Displays the latest raw packet results for the selected probe.
Latest Accumulated	Displays the latest accumulated statistics for the selected probe.
State: Restart	Allows the state of a probe to be controlled: the user can Restart a completed or running probe. When a probe is added, it will automatically start running, depending on how the probe start time is configured. Once a probe has run all of its configured operations, it will be in the "Complete" state. If the SLB is rebooted, all probes will automatically be restarted.
Edit Probe	Displays the Performance Monitoring - Add/Edit Probe web page to edit the currently selected probe.
Delete	Deletes the selected probe, after a confirmation.

The table at the bottom of the page lists information about completed and running probes.

Id	Unique identifier for the probe.
Name	Name assigned to the probe.
State	The current state of the probe: Complete if all operations have been run, or Running if there are still operations that need to be run.
Start Time First Op	The date and time that the first operation started.
Finish Time Last Op	The date time that the most recently completed operation finished.
Error	<p>Any errors reported by the probe:</p> <ul style="list-style-type: none"> ◆ NMT: the current repository is an external source, but the USB thumb drive is not mounted ◆ NDR: the repository directory for the probe does not exist ◆ OPF: failed to open an operation data file ◆ SCT: error initializing a socket ◆ CFG: error retrieving probe configuration ◆ EXP: probe start time has expired
Operations Comp/ Total	The number of operations that have been completed and the total number of operations that will be run.

Performance Monitoring - Add/Edit Probe

The [Performance Monitoring - Add/Edit Probe](#) web page allows a user to add a new Performance Monitoring probe or edit an existing Performance Monitoring probe.

To add a new probe or edit an existing probe:

1. Click the **Network** tab and select the Perf Monitoring option. The [Network > Perf Monitoring](#) page displays.
2. To add a new probe, in the lower section of the page, select the **Add Probe** link. To edit an existing probe, select a probe by clicking the radio button to the right right in the probe's row, then select the **Edit Probe** button. In both cases, the following page displays.

Figure 6-8 Performance Monitoring - Add/Edit Probe

LANTRONIX[®] SLB882/8824

Logout Host: slb2056 User: sysadmin Select port for Configuration WebSSH (DP only) Connected Device (DP only)

Network Services User Authentication Devices Maintenance Quick Setup

Network Settings IP Filter Routing VPN Perf Monitoring

Performance Monitoring - Add/Edit Probe Help?

[Back to Perf Monitoring](#)

Now
 At date/time: June 25 2018 11:05 pm
 After waiting: _____ hours _____ minutes

Probe Type:

Name:

Number of Operations:

Frequency between Operations: seconds

Number of Packets:

Interval between Packets: msec

Timeout: msec

UDP Jitter VoIP Codec:

ICMP Ethernet Interface:

Destination Host:

Destination Port:

Precision: milliseconds microseconds

Data Size: bytes

Verify Data:

Type of Service (TOS):

DNS Name Server IP Address:

Apply

3. Modify the probe settings:

Probe Type	Select from one of the available probe types: <ul style="list-style-type: none"> ◆ DNS Lookup - Performs a DNS lookup on the hostname specified in the Destination Host using the Name Server. By default port 53 is always used as the Destination Port. ◆ HTTP Get - Performs an HTTP Get to the home (root) of the web server at the Destination Host and Destination Port. ◆ ICMP Echo - Sends ICMP Echo (ping) packets to the Destination Host. ◆ TCP Connect - Performs a TCP Connection to the Destination Host and Destination Port. ◆ UDP Echo - Sends UDP Echo packets to the Destination Host and Destination Port. ◆ UDP Jitter - Sends UDP jitter packets using a simplified version of the Cisco IP SLA v2 (Engine II) protocol to the Destination Host and Destination Port. ◆ UDP Jitter VoIP - Sends UDP jitter packets configured to simulate Voice over IP network traffic (VoIP) using a simplified version of the Cisco IP SLA v2 (Engine II) protocol to the Destination Host and Destination Port.
Name	Probe name, up to 40 characters long. Valid characters are letters, numbers, dashes (-), periods and underscores (_).
Number of Operations	Number of operations to perform for the probe. Probes can for a specific number of operations. The valid range is 1 - 1000, and the default is 100.
Frequency between Operations	Time between probe operations, in seconds. The valid range is 5 - 3600 seconds, and the default is 60 seconds.
Number of Packets	Number of packets to send for each probe. For DNS Lookup probes, this is the number of lookups to perform. For HTTP Get probes, this is the number of HTTP Gets to perform. For TCP Connect probes, this is the number of TCP connections to perform. The valid range is 1 - 1000 for the Local repository and 1 - 2000 for a USB. The default is 10 packets.
Interval between Packets	Interval between packets in milliseconds. The valid range is 10 - 5000 milliseconds, and the default is 500 milliseconds. For HTTP Get, DNS Lookup and TCP Connect probes, the timeout must be less than the interval due to a new socket being created and destroyed for each packet.
Start Time	Schedule a time to start the probe: Now starts the probe immediately; At date/time will start the probe at the specified date and time in the future; After waiting will start the probe after waiting a period of time that is less than 24 hours. When the SLB is rebooted, the probe will start according to the Start Time settings: (a) immediately if it set to Now , (b) at a date and time in the future if it is set to At date/time and the date and time is in the future, (c) after waiting a period of time if it is set to After waiting .
Destination Host	The hostname or IP address to send packets to. For DNS Lookup probes this is the hostname to lookup.
Destination Port	The TCP or UDP port to send packets to. For ICMP probes, the port setting is not used. For DNS Lookup probes, the destination port is always port 53. Port 1967 is reserved for the UDP jitter responder. The valid range is 1 - 65535.
Precision	The precision to view results in - milliseconds (the default) or microseconds. Jitter results are always displayed in milliseconds.

Data Size	<p>The size in bytes to use for the payload portion of the packet - this size is in addition to the IPv4 header and the TCP, UDP or ICMP header. Any additional space in the packet that is not used by the protocol will be padded with random data that can be used for data verification (see below).</p> <p>This parameter is only supported for ICMP Echo, TCP Connect, UDP Echo, UDP Jitter, and UDP Jitter VoIP probes. The maximum payload for any probe is 1460 bytes. The minimum payload size for probes is: UDP Jitter VoIP G.729a codec probes - 32 bytes; all other UDP Jitter probes - 64 bytes; ICMP Echo probes - 18 bytes; TCP Connect probes - 1 bytes; UDP Echo probes - 4 bytes.</p> <p>If no data size is specified (e.g., it is set to zero), a default payload size will be used for the probes as follows:</p> <ul style="list-style-type: none"> ◆ ICMP Echo - 56 bytes ◆ UDP Jitter VoIP G.729A - 32 bytes ◆ UDP Jitter (all others) - 64 bytes ◆ TCP Connect and UDP Echo - 256 bytes
Verify Data	If enabled, indicates that the SLB should verify if there is data corruption in the reply packets. This parameter is only supported for ICMP Echo, UDP Echo, UDP Jitter, and UDP Jitter VoIP probes.
Timeout	How long the SLB will wait for a packet to arrive, in milliseconds. If the packet arrives after the timeout it will be considered a Late Arrival error (see Error Conditions). The valid range is 10 - 1000, and the default is 200 msec.
UDP Jitter VoIP Codec	<p>For UDP Jitter VoIP probes, the codec to simulate. The following codecs are available:</p> <ul style="list-style-type: none"> ◆ G.729A - 32 byte packets sent 20 msec apart, 1000 packets per operation, 60 seconds between operations ◆ G.711 A-law - 172 byte packets sent 20 msec apart, 1000 packets per operation, 60 seconds between operations ◆ G.711 mu-law - 172 byte packets sent 20 msec apart, 1000 packets per operation, 60 seconds between operations <p>The default values for the VoIP probes can be overridden to use different packet sizes, intervals, etc.</p>
ICMP Ethernet Interface	For ICMP Echo probes, which Ethernet interface can be used for the probe: both interfaces, Ethernet Port 1, or Ethernet Port 2.
TOS (Type of Service)	Sets the IPv4 Type of Service field in the IPv4 header. This is available for UDP Jitter and UDP Jitter VoIP probes only. The range is 0 - 255, and the default value is 0.
DNS Name Server IP Address	For DNS Lookup probes, the IP address of the DNS name server to use for lookups.

4. Click the **Apply** button.

Performance Monitoring - Results

The Performance Monitoring - Operations page displays all of the operations that have been saved for a selected probe. The probe ID and name are shown at the top of the web page. From this page, the user may select any operation to view its round trip time (RTT) results, or the accumulated statistics for all round trip times in an operation.

An operation consists of sending a specified number of packets to a destination host and optional port, with a specified amount of time between each packet. All results for each operation are stored in one data file.

Round Trip Times

The results for each packet in an operation can be displayed with the **RTT Results** link. Each packet will be displayed with the packet start time and any error that resulted from sending the packet. For non-jitter probes, the total round trip time is displayed in either milliseconds or microseconds, depending on how the probe's precision setting:

```
Probe 6/icmp-probe, operation icmp_170627_235709.dat:
Pkt  Time                RT Time          Result
  1  17-06-27 23:57:09.171    0.419 ms    OK
  2  17-06-27 23:57:09.211    0.378 ms    OK
  3  17-06-27 23:57:09.251    0.366 ms    OK
  4  17-06-27 23:57:09.291    0.354 ms    OK
  5  17-06-27 23:57:09.332    0.448 ms    OK
  6  17-06-27 23:57:09.372    0.382 ms    OK
  7  17-06-27 23:57:09.412    0.308 ms    OK
  8  17-06-27 23:57:09.452    0.334 ms    OK
  9  17-06-27 23:57:09.492    0.365 ms    OK
 10  17-06-27 23:57:09.532    0.361 ms    OK
```

For jitter probes, the source to destination and destination times are displayed in the probe's configured precision:

```
Probe 7/udp-jitter-probe, operation udpjitter_170628_002049.dat:
Pkt  Time                Src To Dst Time  Dst To Src Time  Result
  1  17-06-28 00:20:49.621    31029 usec      44191 usec    OK
  2  17-06-28 00:20:49.717    35409 usec      44170 usec    OK
  3  17-06-28 00:20:49.808    35558 usec      34120 usec    OK
  4  17-06-28 00:20:49.898    25500 usec      34175 usec    OK
  5  17-06-28 00:20:49.988    35210 usec      34196 usec    OK
  6  17-06-28 00:20:50.079    25517 usec      34177 usec    OK
  7  17-06-28 00:20:50.169    35210 usec      54166 usec    Late Arrival
  8  17-06-28 00:20:50.259    25549 usec      34170 usec    OK
  9  17-06-28 00:20:50.350    25313 usec      34255 usec    OK
 10  17-06-28 00:20:50.440    24848 usec      34351 usec    OK
```

Accumulated Statistics

A summary of all round trip time and any error conditions is displayed. The display will vary for non-jitter and jitter results. For example, non-jitter accumulated results will show:

```
Probe 6/icmp-probe, operation icmp_170627_235709.dat:
Operation Type:
  ICMP Echo to 10.0.1.162, Ethernet Port: both
  30 packets sent 40 ms apart, timeout 1000 ms
Operation Start Time: 17-06-27 23:57:09.171
Last Packet RTT: 0.340 msec
Round Trip Time Results:
  Number of RTT: 30
  RTT Min/Avg/Max: 0.306/0.362/0.448 msec
Number of Successes: 30
Number of Errors: 0
  Lost Packet: 0 (0%)
  Out of Sequence: 0
  Late Arrival: 0
  Miscellaneous Error: 0
```

For jitter probes, positive (increasing latency) and negative (decreasing latency) statistics are shown, as well as the number of positive or negative jitter samples in each direction, and the sum and (and sum squared) of the positive or negative jitter times. These numbers give a summary of how much variation there was in latency times and if the variation was small or large.

```
Probe 7/udp-jitter-probe, operation udpjitter_170628_002049.dat:
Operation Type:
  UDP Jitter to 10.0.1.93:50505
  50 packets sent 60 ms apart, timeout 1000 msec
Operation Start Time: 17-06-28 00:20:49.071
Last Packet RTT: 69.334 msec
Round Trip Time Results:
  Number of RTT: 50
  RTT Min/Avg/Max: 57.327/63.863/89.376 msec
One-way Latency Results:
  Number of samples: 50
  Source to Destination Min/Avg/Max: 23.174/27.467/45.206 msec
  Destination to Source Min/Avg/Max: 34.068/36.396/54.166 msec
Jitter, Source to Destination:
  Number of Samples: 49
  Positive and Negative Min/Avg/Max: 1/4/20 msec
  Positive Min/Avg/Max: 1/7/20 msec
  Positive Number Of/Sum of All/Sum of All Squared: 13/100/1090 msec
  Negative Min/Avg/Max: 1/5/20 msec
  Negative Number Of/Sum of All/Sum of All Squared: 17/96/1018 msec
Jitter, Destination to Source:
  Number of Samples: 49
  Positive and Negative Min/Avg/Max: 10/3/20 msec
  Positive Min/Avg/Max: 10/12/20 msec
  Positive Number Of/Sum of All/Sum of All Squared: 7/90/1300 msec
  Negative Min/Avg/Max: 10/12/20 msec
  Negative Number Of/Sum of All/Sum of All Squared: 8/100/1400 msec
Number of Successes: 49
Number of Errors: 1
  Lost Packet: 0 (0%)
  Out of Sequence: 0
  Late Arrival: 1
  Miscellaneous Error: 0
```

Table 6-9 Error Conditions

The following error conditions are detected by the probes. Except where noted, the RTT results for a packet with errors will not be counted in the accumulated statistics.

Error Condition	Description
Timeout	A response was never received for the packet. These packets are listed as Lost Packets under the accumulated statistics.
Late Arrival	A response was received for a packet, but the response was received after the timeout configured for the probe. The SLB will wait at most 2 times the probe's timeout for late arrival packets. The RTT results will be included in the accumulated statistics.

Error Condition	Description
Not Connected	A packet could not be sent because the connection to the destination host could not be established, or because the attempt to send the packet failed.
Sequence Error	A packet response was received with an unexpected sequence number. Possible reasons are: a duplicate packet was received, a response was received after it timed out, a corrupted packet was received and was not detected.
Verify Data Error	A response was received for a packet with payload data that does not match the expected data.
DNS Server Timeout	A DNS lookup could not be completed because the SLB could not connect to the DNS name server.
DNS Lookup Error	A DNS lookup failed - the requested hostname could not be resolved. This is not considered a protocol error, but rather an expected result, depending on the hostname being resolved. The RTT results will be included in the accumulated statistics.
TCP Connect Timeout	A TCP connect could not be completed because a connection to the TCP server could not be established.
HTTP Transaction Timeout	An HTTP Get that failed because no response was received from the HTTP server before the timeout expired.
HTTP Error	An HTTP Get succeeded, but the HTTP content (base page) that was downloaded had errors: missing "HTTP/" header string, missing "Connection: close" string, or response has an HTTP error code (the code was not 200/OK). This is not considered a protocol error. The RTT results will be included in the accumulated statistics.
Generic Error	Any error that does fall into any of the above error conditions.

To view results for a Performance Monitoring probe:

1. Click the **Network** tab and select the **Perf Monitoring** option. The [Network > Perf Monitoring](#) page displays.
2. Select a probe from the table in the lower part of the page and select the **Operations** link. The **Performance Monitoring - Operations** page displays.

Figure 6-10 Performance Monitoring - Operations

The screenshot shows the LANTRONIX SLB882/8824 web interface. At the top, there's a navigation bar with 'Logout', 'Host: slb2056', 'User: sysadmin', and a port selection dropdown (Configuration, WebSSH, Connected Device). Below that are tabs for 'Network', 'Services', 'User Authentication', 'Devices', 'Maintenance', and 'Quick Setup'. The 'Network' tab is active, and 'Perf Monitoring' is selected in the sub-menu. The main heading is 'Performance Monitoring - Operations'. There are links for 'Back to Perf Monitoring', 'Refresh', 'RTT Results', and 'Accumulated Statistics'. A table titled 'Operations' is visible with columns 'Set Number' and 'Set Name'.

3. A table will list all available operations for the selected probe, with the most recent operation listed first. The table may be empty if no operations have been run for the probe or the operations for the probe have been deleted. Select an operation by clicking the radio button to

the far right in the operation's row. The options that are available for that operation will be ungreyed. Select one of the following options:

Refresh	Refreshes the information on the Performance Monitoring - Operations page.
RTT Results	<p>Displays the round trip time (RTT) results for the selected operation in a separate window. The results show:</p> <ul style="list-style-type: none"> ◆ The time that the packet was sent, ◆ The total round trip time for non-jitter probes or the source to destination time and destination to source time for jitter probes, and ◆ The status for the packet - OK/successful or an error condition. <p>For more information, see Round Trip Times or Error Conditions.</p>
Accumulated Results	<p>Displays the accumulated statistics for the selected operation in a separate window. The results show parameters used for the selected operation, and the minimum, average and maximum round trip times for all probes. For jitter probes, the results show minimum, average and maximum one way latency times, as well as jitter results for source to destination and destination to source. For all probes, a summary of lost packets and error conditions is displayed.</p>

Performance Monitoring Commands

Go to [Performance Monitoring Commands](#) to view CLI commands which correspond to the web page entries described above.

7: Services

System Logging and Other Services

Use the [Services > SSH/Telnet/Logging](#) page to:

- ◆ Configure the amount of data sent to the logs.
- ◆ Enable or disable SSH and Telnet logins.
- ◆ Enable a Simple Network Management Protocol (SNMP) agent.

Note: *The SLB branch office manager supports both MIB-II (as defined by RFC 1213) and a private enterprise MIB. The private enterprise MIB provides read-only access to all statistics and configurable items provided by the SLB unit. It provides read-write access to a select set of functions for controlling the SLB unit and device ports. See the MIB definition file for details.*

- ◆ Identify a Simple Mail Transfer Protocol (SMTP) server.
- ◆ Enable or disable SSH and Telnet logins.
- ◆ Configure an audit log.
- ◆ View the status of and manage the SLB units on the secure Lantronix network.
- ◆ Set the date and time.

SSH/Telnet/Logging

To configure SSH, Telnet, and Logging settings:

1. Click the **Services** tab and select the **SSH/Telnet/Logging** option. The following page displays.

Figure 7-1 Services > SSH/Telnet/Logging

The screenshot shows the LANTRONIX SLB882/8824 configuration interface. At the top, there is a navigation bar with tabs for Network, Services, User Authentication, Devices, Maintenance, and Quick Setup. The Services tab is selected, and the SSH/Telnet/Logging option is active. The page title is "SSH/Telnet/Logging".

System Logging

- Network Level: Warning
- Services: Warning
- Authentication: Warning
- Device Ports: Warning
- Diagnostics: Warning
- General: Warning
- Remote Server #1: []
- #2: []

Audit Log

- Enable Log:
- Size: 50 Kbytes
- Include CLI Commands:
- Include in System Log:

SMTP

- Server: []
- Sender: donotreply@\$host.\$domain
- Note: '\$host' and '\$domain' will be substituted with hostname and domain.

SSH

- Enable Logins: Web SSH:
- Timeout: No Yes: 0 minutes
- SSH Port: 22
- DSA Keys:
- Use only SHA2 and Higher:

Telnet

- Enable Logins: Web Telnet:
- Timeout: No Yes: 0 minutes
- Escape Sequence: \x1bT
- Outgoing Telnet:

Web SSH/Web Telnet Settings

- Terminal Buffer Size: 250

Phone Home

- Enable:
- IP Address: []
- Last Attempt: N/A
- Results: N/A

Apply

2. Enter the following settings:

System Logging

Alert Levels	<p>Select one of the following alert levels from the drop-down list for each message category:</p> <ul style="list-style-type: none"> ◆ Off: Disables this type of logging. ◆ Error: Saves messages that are output because of an error. ◆ Warning: Saves message output from a condition that may be cause for concern, in addition to error messages. This is the default for all message types. ◆ Info: Saves informative message, in addition to warning and error messages. ◆ Debug: Saves extraneous detail that may be helpful in tracking down a problem, in addition to information, warning, and error messages.
---------------------	--

Network Level	Messages concerning the network activity, for example about Ethernet and routing.
Services	Messages concerning services such as SNMP and SMTP.
Authentication	Messages concerning user authentication.
Device Ports	Messages concerning device ports and connections.
Diagnostics	Messages concerning system status and problems.
General	Any message not in the categories above.
Remote Servers (#1 and #2)	IP address of the remote server(s) where system logs are stored. The system log is always saved to local SLB storage. It is retained through SLB branch office manager reboots for files up to 200K. Saving the system log to a server that supports remote logging services (see RFC 3164) allows the administrator to save the complete system log history.

Audit Log

Enable Log	Select to save a history of all configuration changes in a circular log. Disabled by default. The audit log is saved through SLB reboots.
Size	The log has a default maximum size of 50 Kbytes (approximately 500 entries). You can set the maximum size of the log from 1 to 500 Kbytes.
Include CLI Commands	Select to cause the audit log to include the CLI commands that have been executed. Disabled by default.
Include In System Log	If enabled, the contents of the audit log are added to the system log (under the General/Info category/level). Disabled by default.

SMTP

Server	IP address of your network's Simple Mail Transfer Protocol (SMTP) relay server.
Sender	The email address of the sender of outgoing emails. The strings "\$host" and "\$domain" can be part of the email address - they will be substituted with the actual hostname and domain. The default is donotreply@\$host.\$domain.

SSH

Enable Logins	Enables or disables SSH logins to the SLB branch office manager to allow users to access the CLI using SSH. Enabled by default. This setting does not control SSH access to individual device ports. (See Device Ports - Settings (on page 113) for information on enabling SSH access to individual ports.) Most system administrators enable SSH logins, which is the preferred method of accessing the system.
Web SSH	Enables or disables the ability to access the SLB command line interface or device ports (connect direct) through the Web SSH window. Disabled by default.
Timeout	If you enable SSH logins, you can cause an idle connection to disconnect after a specified number of minutes. Select Yes and enter a value of from 1 to 30 minutes. Note: You must reboot the unit before a change will take effect.
SSH Port	Allows you to change the SSH login port to a different value in the range of 1 - 65535. The default is 22. Note: You must reboot the unit before a change will take effect.

DSA Keys	Enables or disables support for DSA keys for incoming and outgoing connections for the StLB unit. Any imported or exported DSA keys will be retained but will not be visible on the web or the CLI. Enabled by default.
Use only SHA2 and Higher	Enables or disables support for only SHA2 and higher ciphers for incoming connections for the SLC unit. Disabled by default. Enabling this option will also disable MACs with tag sizes lower than 128 bits (e.g. umac-64-etm@openssh.com and umac-64@openssh.com).

Telnet

Enable Logins	Enables or disables Telnet logins to the SLB branch office manager to allow users to access the CLI using Telnet. Disabled by default. This setting does not control Telnet access to individual device ports. (See Device Ports - Settings (on page 113) for information on enabling Telnet access to individual ports.) You may want to keep this option disabled for security reasons.
Web Telnet	Enables or disables the ability to access the SLB command line interface or device ports (connect direct) through the Web Telnet window. Disabled by default.
Timeout	If you enable Telnet logins, you can cause an idle connection to disconnect after a specified number of minutes. Select Yes and enter a value of from 1 to 30 minutes. Note: You must reboot the unit before a change will take effect.
Escape Sequence	A single character or a two-character sequence that causes the SLB unit to terminate a Telnet client. Currently the Escape Sequence is only used for Web Telnet sessions. The default value is Esc+T (escape key, then uppercase "T" performed quickly but not simultaneously). You would specify this value as \x1bT, which is hexadecimal (\x) character 27 (1B) followed by a T. A control character can be specified with the hexadecimal number for the control character; for example, Control-E can be specified as \x05. Note that some browsers do not report key press events if Control is pressed for non-alphanumeric keys, so it is recommended to only use letters with Control character sequences.
Outgoing Telnet	Enables or disables the ability to create Telnet out connections.

Web SSH/Web Telnet Settings

Terminal Buffer Size	Number of lines in the Web SSH or Web Telnet terminal window that are available for scrolling back through output.
-----------------------------	--

Phone Home

Enable	If enabled, allows SLB branch office manager to directly contact a vSLM management appliance and request addition to the database
IP Address	IP address of the vSLM management appliance.
Last Attempt (view only)	Displays the date and time of last connection attempt.
Results (view only)	Indicates whether the attempt was successful.

- To save, click the **Apply** button.

SNMP

Simple Network Management Protocol (SNMP) is a set of protocols for managing complex networks.

1. Click the **Services** tab and select the **SNMP** option. The following page displays:

Figure 7-2 Services > SNMP

LANTRONIX[®] SLB882/8824

Logout Host: slb2056 User: sysadmin

Select port for Configuration WebSSH (DP only) Connected Device (DP only)

Network Services User Authentication Devices Maintenance Quick Setup

SSH/Telnet/Logging SNMP NFS/CIFS Secure Lantronix Network Date & Time Web Server ConsoleFlow

SNMP Help?

Enable Agent: [Top Level MIB](#) [SLB MIB](#)

Enable Traps:

NMS #1:

NMS #2:

Location:

Contact:

Communities

Read-Only:

Read-Write:

Trap:

Enable v1:

Enable v2c:

Alarm Delay: seconds

Version 3

Security: No Auth/No Encrypt Auth/No Encrypt Auth/Encrypt

Auth with: MD5 SHA

Encrypt with: DES AES

V3 Read-Only User

User Name:

Password:

Retype Password:

Passphrase:

Retype Passphrase:

V3 Read-Write User

User Name:

Password:

Retype Password:

Passphrase:

Retype Passphrase:

SNMP Traps Sent/Fail: 0/0

Apply

Traps Enabled for Sending	
coldStart (1.3.6.1.6.3.1.1.5.1)	<input checked="" type="checkbox"/>
linkDown (1.3.6.1.6.3.1.1.5.3)	<input checked="" type="checkbox"/>
linkUp (1.3.6.1.6.3.1.1.5.4)	<input checked="" type="checkbox"/>
authenticationFailure (1.3.6.1.6.3.1.1.5.5)	<input checked="" type="checkbox"/>
slbEventPowerSupply (1.3.6.1.4.1.244.1.12.0.1)	<input checked="" type="checkbox"/>
slbEventSysadminPassword (1.3.6.1.4.1.244.1.12.0.2)	<input checked="" type="checkbox"/>
slbEventSLBShutdown (1.3.6.1.4.1.244.1.12.0.3)	<input checked="" type="checkbox"/>
slbEventDevicePortData (1.3.6.1.4.1.244.1.12.0.4)	<input checked="" type="checkbox"/>
slbEventDevicePortSLMData (1.3.6.1.4.1.244.1.12.0.5)	<input checked="" type="checkbox"/>
slbEventDevicePortSLMConfig (1.3.6.1.4.1.244.1.12.0.6)	<input checked="" type="checkbox"/>
slbEventOverCurrentAlarm (1.3.6.1.4.1.244.1.12.0.7)	<input checked="" type="checkbox"/>
slbEventPowerOutletStateChange (1.3.6.1.4.1.244.1.12.0.8)	<input checked="" type="checkbox"/>
slbEventDevicePortDeviceLowTemp (1.3.6.1.4.1.244.1.12.0.9)	<input checked="" type="checkbox"/>
slbEventDevicePortDeviceHighTemp (1.3.6.1.4.1.244.1.12.0.10)	<input checked="" type="checkbox"/>
slbEventDevicePortDeviceLowHumidity (1.3.6.1.4.1.244.1.12.0.11)	<input checked="" type="checkbox"/>
slbEventDevicePortDeviceHighHumidity (1.3.6.1.4.1.244.1.12.0.12)	<input checked="" type="checkbox"/>
slbEventDevicePortDeviceError (1.3.6.1.4.1.244.1.12.0.13)	<input checked="" type="checkbox"/>
slbEventUSBAction (1.3.6.1.4.1.244.1.12.0.16)	<input checked="" type="checkbox"/>
slbEventInternalTemp (1.3.6.1.4.1.244.1.12.0.15)	<input checked="" type="checkbox"/>
slbEventDevicePortError (1.3.6.1.4.1.244.1.12.0.17)	<input checked="" type="checkbox"/>
slbEventNoDialToneAlarm (1.3.6.1.4.1.244.1.12.0.18)	<input checked="" type="checkbox"/>
slbEventNetworkFailover (1.3.6.1.4.1.244.1.12.0.23)	<input checked="" type="checkbox"/>

2. Enter the following:

Enable Agent	Enables or disables SNMP agent, which allows read-only access to the system. Disabled by default.
Enable Traps	<p>Traps are notifications of certain critical events. Disabled by default. This feature is applicable when SNMP is enabled. Traps that the SLB unit sends include:</p> <ul style="list-style-type: none"> ◆ coldStart (generic trap 0, OID 1.3.6.1.6.3.1.1.5.1) ◆ linkDown (generic trap 2, OID 1.3.6.1.6.3.1.1.5.3) ◆ linkUp (generic trap 3, OID 1.3.6.1.6.3.1.1.5.4) ◆ authenticationFailure (generic trap 4, OID 1.3.6.1.6.3.1.1.5.5) ◆ slbEventPowerSupply (1.3.6.1.4.1.244.1.12.0.1) ◆ slbEventSysadminPassword (1.3.6.1.4.1.244.1.12.0.2) ◆ slbEventSLCShutdown (1.3.6.1.4.1.244.1.12.0.3) ◆ slbEventDevicePortData (1.3.6.1.4.1.244.1.12.0.4) ◆ slbEventDevicePortSLMData (1.3.6.1.4.1.244.1.12.0.5) ◆ slbEventDevicePortSLMConfig (1.3.6.1.4.1.244.1.12.0.6) ◆ slbEventOverCurrentAlarm (1.3.6.1.4.1.244.1.12.0.7) ◆ slbEventPowerOutletStateChange (1.3.6.1.4.1.244.1.12.0.8) ◆ slbEventDevicePortDeviceLowTemp (1.3.6.1.4.1.244.1.12.0.9) ◆ slbEventDevicePortDeviceHighTemp (1.3.6.1.4.1.244.1.12.0.10) ◆ slbEventDevicePortDeviceLowHumidity (1.3.6.1.4.1.244.1.12.0.11) ◆ slbEventDevicePortDeviceHighHumidity (1.3.6.1.4.1.244.1.12.0.12) ◆ slbEventDevicePortDeviceError (1.3.6.1.4.1.244.1.12.0.13) ◆ slbEventInternalTemp (1.3.6.1.4.1.244.1.12.0.15) ◆ slbEventUSBAction (1.3.6.1.4.1.244.1.12.0.16) ◆ slbEventDevicePortError (1.3.6.1.4.1.244.1.12.0.17) ◆ slbEventNoDialToneAlarm (1.3.6.1.4.1.244.1.12.0.18) ◆ slbEventNetworkFailover (1.3.6.1.4.1.244.1.12.0.23) <p>The SLC or SLB unit sends the traps to the host identified in the NMS #1 and NMS #2 field.</p>
NMS #1 (or #2)	When SNMP is enabled, an NMS (Network Management System) acts as a central server, requesting and receiving SNMP-type information from any computer using SNMP. The NMS can request information from the SLB unit and receive traps from the SLB device. Enter the IP address of the NMS server. Required if you selected Enable Traps .
Location	Physical location of the SLB branch office manager (optional). Useful for managing the SLB device using SNMP. Up to 20 characters.
Contact	Description of the person responsible for maintaining the SLB, for example, a name (optional). Up to 20 characters.

Communities

Read-Only	A string that acts like a password for an SNMP manager to access the read-only data the SLB unit the SNMP agent provides. The Read-Only Community is used for SNMP v1 and v2c. The default is public .
Read-Write	A string that acts like a password for an SNMP manager to access the read-only data the SLB SNMP agent provides and to modify data where permitted. The Read-Write Community is used for SNMP v1 and v2c. The default is private .
Trap	The trap used for outgoing generic and enterprise traps. Traps sent with the Event trigger mechanism still use the trap community specified with the Event action. The default is public .

Enable v1	If checked, SNMP version 1 (which uses the Read-Only and Read-Write Communities) is enabled. The default is disabled.
Enable v2c	If checked, SNMP version 2c (which uses the Read-Only and Read-Write Communities) is enabled. The default is enabled.
Alarm Delay	Number of seconds delay between outgoing SNMP traps.

Version 3

Security	Levels of security available with SNMP v3. <ul style="list-style-type: none"> ◆ No Auth/No Encrypt: No authentication or encryption. ◆ Auth/No Encrypt: Authentication but no encryption. (default) ◆ Auth/Encrypt: Authentication and encryption.
Auth with	For Auth/No Encrypt or Auth/Encrypt , the authentication method: <ul style="list-style-type: none"> ◆ MD5: Message-Digest algorithm 5 (default) ◆ SHA: Secure Hash Algorithm
Encrypt with	Encryption standard to use: <ul style="list-style-type: none"> ◆ DES: Data Encryption Standard (default) ◆ AES: Advanced Encryption Standard

V3 Read-Only User

User Name	SNMP v3 is secure and requires user-based authorization to access SLB MIB objects. Enter a user ID. The default is snmpuser . Up to 20 characters.
Password/Retype Password	Password for a user with read-only authority to use to access SNMP v3. The default is SNMPPASS . Up to 20 characters.
Passphrase/Retype Passphrase	Passphrase associated with the password for a user with read-only authority. Up to 20 characters. If this is not specified it will default to the V3 Password.

V3 Read-Write User

User Name	SNMP v3 is secure and requires user-based authorization to access SLB MIB objects. Enter a user ID for users with read-write authority. The default is snmprwuser . Up to 20 characters.
Password/Retype Password	Password for the user with read-write authority to use to access SNMP v3. The default is SNMPRWPASS . Up to 20 characters.
Passphrase/Retype Passphrase	Passphrase associated with the password for a user with read-write authority. Up to 20 characters.

3. To save, click the **Apply** button.

SNMP, SSH, Telnet, and Logging Commands

Go to [Services Commands \(on page 321\)](#) and [Logging Commands \(on page 304\)](#) to view CLI commands which correspond to the web page entries described above.

NFS and SMB/CIFS

Use the [Services > NFS/CIFS](#) page if you want to save configuration and logging data onto a remote NFS server, or export configuration by means of an exported CIFS share.

Mounting an NFS shared directory on a remote network server onto a local SLB directory enables the SLB branch office manager to store device port logging data on that network server. This configuration avoids possible limitations in the amount of disk space on the SLB unit available for the logging file(s). You may also save SLB configurations on the network server.

Similarly, use SMB/CIFS (Server Message Block/Common Internet File System), Microsoft's file-sharing protocol, to export a directory on the SLB branch office manager as an SMB/CIFS share. The SLB exports a single read-write CIFS share called "public," with the subdirectory The `config` directory, which contains saved configurations and is read-write.

The share allows users to access the contents of the directory or map the directory onto a Windows computer.

To configure NFS and SMB/CIFS:

1. Click the **Services** tab and select the **NFS/CIFS** option. The following page displays:

Figure 7-3 Services > NFS/CIFS

The screenshot shows the LANTRONIX SLB882/8824 web interface. At the top, there is a navigation bar with tabs for Network, Services (selected), User Authentication, Devices, Maintenance, and Quick Setup. Below the navigation bar, there are links for SSH/Telnet/Logging, SNMP, NFS/CIFS (selected), Secure Lantronix Network, Date & Time, Web Server, and ConsoleFlow. The main content area is titled 'NFS & SMB/CIFS' and contains two sections: 'NFS Mounts' and 'SMB/CIFS Share'.

NFS Mounts

	Remote Directory	Local Directory	Read-Write	Mount
#1:	<input type="text"/>	<input type="text"/>	<input type="checkbox"/>	<input type="checkbox"/>
#2:	<input type="text"/>	<input type="text"/>	<input type="checkbox"/>	<input type="checkbox"/>
#3:	<input type="text"/>	<input type="text"/>	<input type="checkbox"/>	<input type="checkbox"/>

SMB/CIFS Share

The SLB can be configured to share a directory containing the system logs to a Microsoft Windows network. This directory can also be used for saving SLB configurations via [Firmware & Configurations](#).

Share SMB/CIFS directory:

Network Interfaces: Eth1 (172.19.100.59) Eth2

CIFS User Password:

Retype Password:

Workgroup:

The SMB/CIFS share can be accessed by the 'cifsuser' login.

Apply

2. Enter the following for up to three directories:

NFS Mounts

Remote Directory	The remote NFS share directory in the format: nfs_server_hostname or ipaddr:/exported/path
Local Directory	The local directory on the SLB unit on which to mount the remote directory. The SLB device creates the local directory automatically.
Read-Write	If enabled, indicates that the SLB device can write files to the remote directory. If you plan to log port data or save configurations to this directory, you must enable this option.
Mount	Select the checkbox to enable the SLB branch office manager to mount the file to the NFS server. Disabled by default.

3. Enter the following:

SMB/CIFS Share

Share SMB/CIFS directory	Select the checkbox to enable the SLB unit to export an SMB/CIFS share called "public." Disabled by default.
Network Interfaces	Select the network ports from which the share can be seen. The default is for the share to be visible on both network ports.
CIFS User Password/Retype Password	Only one user special username (cifsuser) can access the CIFS share. Enter the CIFS user password in both password fields. The default user password is CIFSPASS . More than one user can access the share with the cifsuser user name and password at the same time.
Workgroup	The Windows workgroup to which the SLB branch office manager belongs. Every PC exporting a CIFS share must belong to a workgroup. Can have up to 15 characters.

4. To save, click the **Apply** button.

NFS and SMB/CIFS Commands

Go to [NFS and SMB/CIFS Commands \(on page 310\)](#) to view CLI commands which correspond to the web page entries described above.

Secure Lantronix Network

Use the **Secure Lantronix Network** option to view and manage Lantronix console servers, branch office managers and Spider devices on the local subnet.

Note: *Status and statistics shown on the web interface represent a snapshot in time. To see the most recent data, reload the web page by clicking the **Refresh** link.*

To access Lantronix console servers, branch office managers and Spider devices on the local network:

1. Click the **Services** tab and select the **Secure Lantronix Network** option. The following page displays with an entry for each device discovered on the network. If Web SSH is enabled, device ports that have SSH In enabled are shown in a bright green.

Settings that control the behavior of Web SSH and Web Telnet are on the [SSH/Telnet/Logging](#) web page. For tips on troubleshooting browser issues, see [Troubleshooting Browser Issues](#). For tips on Web SSH or Web Telnet copy and paste functionality, see [Web SSH/Telnet Copy and Paste](#).

Figure 7-4 Services > Secure Lantronix Network

The screenshot shows the Lantronix SLB882/8824 web interface. The main content area is titled "Secure Lantronix Network" and contains the following information:

Secure Lantronix Managers and Spiders on the local subnet.
Each host can be managed by selecting its IP address.

9 Device(s) found.

Hostname	Model	IP Address/ Web Interface	FW Ver	SSH/ Telnet to CLI	Ports Click on bright green ports to Web SSH or Web Telnet.
slb2056	SLB882	172.19.100.59	6.5.0.0RC10	SSH	1 3 5 7 2 4 6 8
slc0874	SLC8016	172.19.100.122	7.6.0.0R3	N/A	1 3 5 7 9 11 13 15 2 4 6 8 10 12 14 16
slc-kk-06ec	SLC8016	172.19.100.168	7.6.0.0R3	N/A	1 3 5 7 9 11 13 15 2 4 6 8 10 12 14 16
slc037e	SLC8048	172.19.100.144	7.6.0.0R4	N/A	1 3 5 7 9 11 13 15 17 19 21 23 25 27 29 31 33 35 37 39 41 43 45 47 2 4 6 8 10 12 14 16 18 20 22 24 26 28 30 32 34 36 38 40 42 44 46 48
slca508	SLC8048	172.19.100.236	7.5.0.0R22	SSH Telnet	1 3 5 7 9 11 13 15 17 19 21 23 25 27 29 31 33 35 37 39 41 43 45 47 2 4 6 8 10 12 14 16 18 20 22 24 26 28 30 32 34 36 38 40 42 44 46 48
slc4331	SLC8048	172.19.100.124	7.6.0.0R4	N/A	1 3 5 7 9 11 13 15 17 19 21 23 25 27 29 31 33 35 37 39 41 43 45 47 2 4 6 8 10 12 14 16 18 20 22 24 26 28 30 32 34 36 38 40 42 44 46 48
slcfc2f	SLC8048	172.19.100.17	7.6.0.0R4	SSH Telnet	1 3 5 7 9 11 13 15 17 19 21 23 25 27 29 31 33 35 37 39 41 43 45 47 2 4 6 8 10 12 14 16 18 20 22 24 26 28 30 32 34 36 38 40 42 44 46 48
slcfc61	SLC8016	172.19.100.98	7.6.0.0R3	SSH Telnet	1 3 5 7 9 11 13 15 2 4 6 8 10 12 14 16
slcfc2b	SLC8016	172.19.100.171	7.6.0.0R2	N/A	1 3 5 7 9 11 13 15 2 4 6 8 10 12 14 16

2. Access your device or device port through any of the methods below.

To directly access the web interface for a secure Lantronix device:

1. Make sure Web Telnet and Web SSH is enabled for the specific device or device port.
2. Click the IP address of a specific secure Lantronix device to open a new browser page with the web interface for the selected secure Lantronix device.
3. Log in as usual.

Figure 7-5 IP Address Login Page

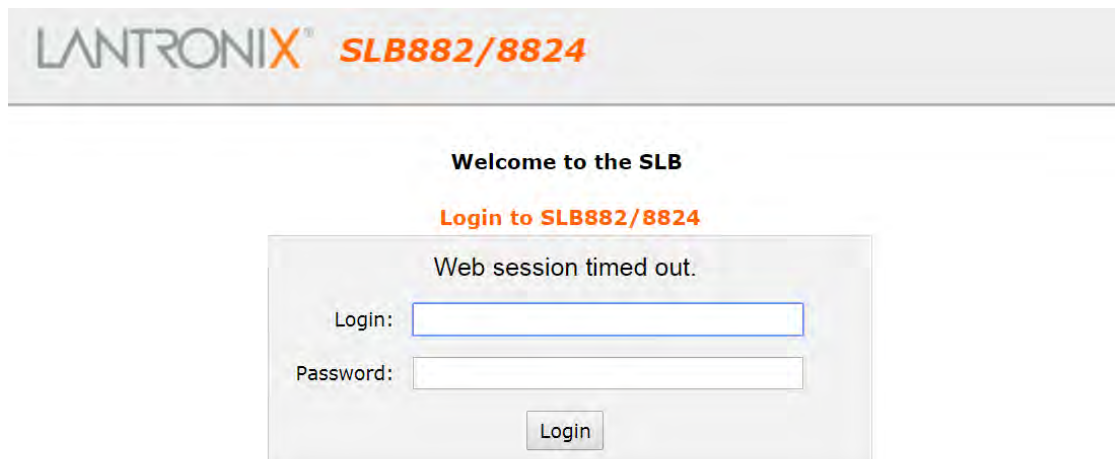

To directly access the CLI interface for a device:

1. Make sure Web Telnet and/or Web SSH is enabled for the specific device or device port you wish to access.
2. Click the **SSH** or **Telnet** link in the SSH/Telnet to CLI column directly beside the port you would like to access.
 - ◆ If **Web SSH** and **SSH to the CLI** are enabled, an SSH link will display and be accessible beside the specific port(s). Clicking this link will open a new Web SSH session.
 - ◆ If **Web Telnet** and **Telnet to the CLI** are enabled, a Telnet link will display and be accessible beside the specific port(s). Clicking this link will open a new Web Telnet session.
 - ◆ If neither Web Telnet and/or Web SSH are enabled, “N/A” will display beside the ports.

The Web SSH or Web Telnet session appears. See [Figure 7-6](#) below.

Figure 7-6 SSH or Telnet CLI Session

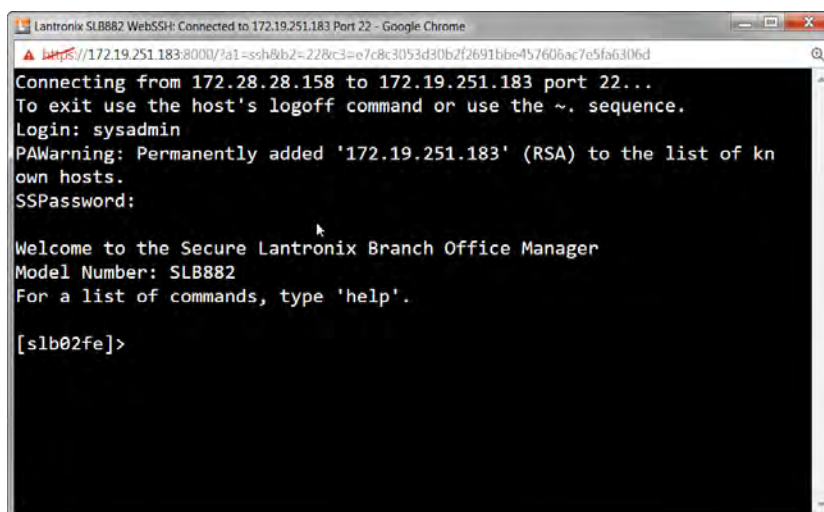

To directly access a specific port on a particular device:

1. Click a port number in a green square beside the specific device.



- a. Enabled port numbers are in a bright green box and will allow you to select either a **WebSSH** or a **WebTelnet** session. If enabled, an SSH or Telnet popup window appears depending on what is clicked. See [Figure 7-6](#).
- b. Disabled port numbers are in a dark green box and you will see a popup:

Figure 7-7 Disabled Port Number Popup Window

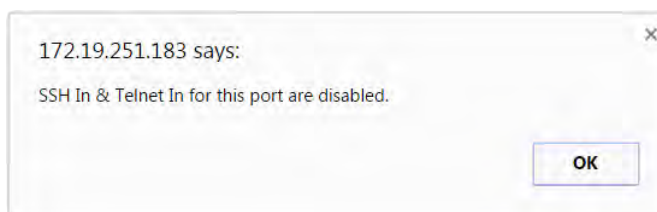

2. Click **OK** and login to the CLI interface which appears. See [Figure 7-6](#).

To configure how secure Lantronix devices are searched for on the network:

1. Click the **Search Options** link on the top right of the [Services > Secure Lantronix Network](#) page. The following web page displays:

Figure 7-8 Services > Secure Lantronix Network > Search Options

LANTRONIX[®] SLB882/8824

Logout Host: slb2056 User: sysadmin

Select port for Configuration WebSSH (DP only) Connected Device (DP only)

Network **Services** User Authentication Devices Maintenance Quick Setup

SSH/Telnet/Logging SNMP NFS/CIFS Secure Lantronix Network Date & Time Web Server ConsoleFlow

Secure Lantronix Network - Search Options Help?

Secure Lantronix Network Search: Local Subnet Manually Entered IP Address List Both

IP Address:

Add IP Address Delete IP Address

IP Address List
No IP Address

Apply

2. Enter the following:

Secure Lantronix Network Search	<p>Select the type of search you want to conduct.</p> <ul style="list-style-type: none"> ◆ Local Subnet performs a broadcast to detect secure Lantronix devices on the local subnet. ◆ Manually Entered IP Address List provides a list of IP addresses that may not respond to a broadcast because of how the network is configured. ◆ Both is the default selection.
IP Address	If you selected Manually Entered IP Address List or Both, enter the IP address of the secure Lantronix device you want to find and manage.

3. If you entered an IP address, click the **Add IP Address** button. The IP address displays in the IP Address List.
4. Repeat steps 2 and 3 for each IP address you want to add.
5. To delete an IP address from the IP Address List, select the address and click the **Delete IP Address** button.
6. Click the **Apply** button. When the confirmation message displays, click **Secure Lantronix Network** on the main menu. The [Services > Secure Lantronix Network](#) page displays the secure Lantronix devices resulting from the search. You can now manage these devices.

Troubleshooting Browser Issues

Depending on which browser you are using and what type of SSL certificate the SLB web server is configured with, there may be errors connecting to a Web SSH or Web Telnet session. These errors may be the standard browser error displayed for self-signed or untrusted certificates ("There is a problem with this website's security certificate." or "Your connection is not private.").

The SSL server that handles Web SSH and Web Telnet sessions is accessible on port 8000, instead of the standard port 443 for SSL connections. It is recommended that the SLB be configured to use a SSL certificate from a Certificate Authority to prevent issues accessing Web SSH and Web Telnet terminals. If your SLB web server is configured to use a self-signed or

untrusted SSL certificate, refer to the notes below for how to work around this for various browsers.

When an SLB is configured with a SSL certificate that is either a wildcard certificate or associated with a specific name, in order to establish a Web SSH or Web Telnet session to the SLB unit, the unit must be able to successfully perform a reverse lookup on any IP address to which Web SSH or Web Telnet requests are sent. For example, if a unit is configured with a SSL certificate for the name "slbXYZ.lantronix.com", and the unit website is being accessed in a browser with "https://slbXYZ.lantronix.com", the unit needs to be configured with a name server that will allow the unit to perform a reverse lookup on the IP address associated with slbXYZ.lantronix.com. Failure to perform a reverse lookup on a name may result in name mismatch errors in the browser when it attempts to open the Web SSH or Web Telnet window.

If you are unable to connect to a Web SSH or Web Telnet session for a reason other than a browser SSL certificate issue, restarting the SSL server on port 8000 may resolve the connection problem. This can be done by restarting the web server (with the CLI command "admin web restart") or by disabling both Web SSH and Web Telnet on the [SSH/Telnet/Logging](#) web page, and then re-enabling them.

- ◆ **Chrome** - For the greatest ease of use with Web SSH and Web Telnet, when the SLB web server is using a self-signed SSL certificate, use the Chrome browser. When the user accepts the self-signed SSL certificate in the browser for the primary SLB website, the self-signed SSL certificate is accepted for all ports - including port 8000 - for the SLB website.
- ◆ **Firefox** - When accessing the SLB website with Firefox, and when the SLB web server is using a self-signed SSL certificate, accepting the self-signed SSL certificate in the browser for the primary SLB website will only accept the certificate for port 443. It will not accept the certificate for port 8000. This may result in a popup being displayed in the Web SSH or Web Telnet window indicating that the browser needs to accept a certificate. To accept the self-signed certificate for port 8000, go to Firefox -> Options (or Preferences) -> Advanced -> Certificates -> View Certificates -> Servers, and add an exception for the SLB IP address or hostname, with port 8000.
- ◆ **Internet Explorer** - When accessing the SLB website with Internet Explorer, and when the SLB web server is using a self-signed SSL certificate, Explorer will grant access to the Web SSH and Web Telnet terminals if (a) the host name or common name in the self-signed certificate matches the name (or IP address) being used to access the SLB website, and (b) Explorer has imported and trusted the self-signed certificate. A custom self-signed certificate with the SLB name can be generated via the [Services - SSL Certificate](#) web page or the admin web certificate custom CLI command.

Once the SLB web server has been configured to use the custom self-signed certificate, follow these steps for Internet Explorer to trust the custom certificate:

- ◆ In Internet Explorer, browse to the SLB website whose certificate you want to trust.
- ◆ When the message "There is a problem with this website's security certificate.", choose **Continue to this website (not recommended)**.
- ◆ In Internet Explorer, select **Tools -> Internet Options**.
- ◆ Select **Security -> Trusted Sites -> Sites**.
- ◆ Verify or fill in the SLB website URL in the **Add this website** field, click **Add**, and then **Close**.
- ◆ Close the **Internet Options** dialog with either **OK** or **Cancel**.
- ◆ Refresh the Internet Explorer web page with the SLB website.
- ◆ When the message "There is a problem with this website's security certificate", choose **Continue to this website (not recommended)**.

- ◆ Click on the red **Certificate Error** at the right of the URL address bar and select **View certificates**.
- ◆ In the dialog that displays, click on **Install Certificate**, then in the **Certificate Import Wizard**, click **Next**.
- ◆ On the next page select **Place all certificates in the following store**.
- ◆ Click **Browse**, select **Trusted Root Certification Authorities**, and click **OK**.
- ◆ Back in the **Certificate Import Wizard**, click **Next**, then **Finish**.
- ◆ If you get a **Security Warning** message box, click **Yes**.
- ◆ Dismiss the **Import was successful** message box with **OK**.
- ◆ In Internet Explorer, select **Tools -> Internet Options**.
- ◆ Select **Security -> Trusted Sites -> Sites**.
- ◆ Select the SLB website URL you just added, click **Remove**, then **Close**.
- ◆ Now shut down all running instances of Internet Explorer, and start up Internet Explorer again.
- ◆ The SLB website's certificate should now be trusted.

Web SSH/Telnet Copy and Paste

There are security issues with letting a web page access the system clipboard, which is the main clipboard on a system that is shared between all applications. Because of this, browsers limit access to the system clipboard. The Web SSH and Web Telnet window provide copy and paste functionality via a right-click menu: the Copy option will copy what is highlighted in the Web SSH or Web Telnet window into an internal (non-system) clipboard, and the contents can be pasted into the Web SSH or Web Telnet window with the Paste.

Support for copying and pasting content between the system clipboard and the Web SSH or Web Telnet window will vary from browser to browser. With the exception of Internet Explorer, most browsers will not allow highlighted content from the Web SSH or Web Telnet window to be copied to the system clipboard (Internet Explorer will display a prompt confirming the copy). Likewise, most browsers will not allow content from the system clipboard to be directly pasted into the Web SSH or Web Telnet window with the standard Control-V paste key sequence. With some browsers, the user will be able to use the Paste from browser option in the right-click menu to paste content from the system clipboard into a text field in a popup, and after hitting Enter, the content will be sent to the Web SSH or Web Telnet window.

Secure Lantronix Network Commands

Go to [Secure Lantronix Network Commands \(on page 324\)](#) to view CLI commands which correspond to the web page entries described above.

Date and Time

You can specify the current date, time, and time zone at the SLB's location (default), or the SLB branch office manager can use NTP to synchronize with other NTP devices on your network.

To set the local date, time, and time zone:

1. Click the **Services** tab and select the **Date & Time** option. The following page displays:

Figure 7-9 Services > Date & Time

The screenshot shows the LANTRONIX SLB882/8824 web interface. At the top, there is a navigation menu with 'Services' selected. Below the menu, there is a 'Date & Time' section. The 'Change Date/Time' checkbox is unchecked. The 'Date' field is set to April 27, 2018. The 'Time' field is set to 04:25:53 pm. The 'Time Zone' is set to GMT. Below this, there is an 'Enable NTP' checkbox which is unchecked. To the right of this checkbox, there is a note: 'The SLB can synchronize its clock with a remote time server using NTP.' Below the 'Enable NTP' checkbox, there is a 'Synchronize via' section with two radio button options: 'Broadcast from NTP Server' (selected) and 'Poll NTP Server(s)'. Under 'Broadcast from NTP Server', there are three input fields labeled '#1:', '#2:', and '#3:'. Under 'Poll NTP Server(s)', there is a dropdown menu with the text 'NTP Pool: 0.pool.ntp.org (random)'. At the bottom of the section, there is an 'Apply' button.

2. Enter the following:

Change Date/Time	Select the checkbox to manually enter the date and time at the SLB's location.
Date	From the drop-down lists, select the current month, day, and year.
Time	From the drop-down lists, select the current hour and minute.
Time Zone	From the drop-down list, select the appropriate time zone.

3. To save, click the **Apply** button.

To synchronize the SLB unit with a remote timeserver using NTP:

1. Enter the following:

Enable NTP	Select the checkbox to enable NTP synchronization. NTP is disabled by default.
-------------------	--

Synchronize via	<p>Select one of the following:</p> <ul style="list-style-type: none"> ◆ Broadcast from NTP Server: Enables the SLB branch office manager to accept time information periodically transmitted by the NTP server. This is the default if you enable NTP. ◆ Poll NTP Server: Enables the SLB unit to query the NTP Server for the correct time. If you select this option, complete one of the following: <ul style="list-style-type: none"> ➢ Local: Select this option if the NTP servers are on a local network, and enter the IP address of up to three NTP servers. This is the default, and it is highly recommended. ➢ Public: Select this option if you want to use a public NTP server, and select the address of the NTP server from the drop-down list. This is not recommended because of the high load on many public NTP servers. All servers in the drop-down list are stratum-2 servers. (See www.ntp.org for more information.) Each public NTP server has its own usage rules --please refer to the appropriate web site before using one. Our listing them here is to provide easy configuration but does not indicate any permission for use.
------------------------	---

2. To save, click the **Apply** button.

Date and Time Commands

Go to [Date and Time Commands \(on page 289\)](#) to view CLI commands which correspond to the web page entries described above.

Web Server

The Web Server supports all versions of the TLS protocol, but due to security concerns, does not support any versions of the SSL protocol. The Web Server page allows the system administrator to:

- ◆ Configure attributes of the web server.
- ◆ View and terminate current web sessions.
- ◆ Import a site-specific SSL certificate.
- ◆ Enable an iGoogle gadget that displays the status of ports on multiple SLBs.

To configure the Web Server:

1. Click the **Services** tab and select the **Web Server** option. The following page appears:

Figure 7-10 Services > Web Server

LANTRONIX® SLB882/8824

Host: slb2056
User: sysadmin

Select port for: Configuration WebSSH (DP only) Connected Device (DP only)

Logout

Network Services User Authentication Devices Maintenance Quick Setup

SSH/Telnet/Logging SNMP NFS/CIFS Secure Lantronix Network Date & Time Web Server ConsoleFlow

Web Server Help?

Timeout: No
 Yes, minutes (5-120): [Web Sessions](#)

Enable TLS v1.0 Protocol: [SSL Certificate](#)

Enable TLS v1.1 Protocol:

Cipher: High (256,168,128)
 High (256,168,128), Medium (128)

Use only SHA2 and Higher Ciphers:
Note: Changing TLS protocol or cipher requires a reboot or the CLI command "admin web restart".

Group Access:

Banner:
Note: Line feeds can be included in the banner with the "\n" character sequence.

Network Interfaces: Eth1 Eth2 PPP

Run Web Server: Setting can be changed via the CLI.

Enable iGoogle Gadget Web Content:

Apply

2. Enter the following fields:

Timeout	<ul style="list-style-type: none"> ◆ Select No to disable Timeout. ◆ Select Yes to enable timeout. Enter the number of minutes (must be between 5 and 120 minutes) after which the SLB web session times out. The default is 5. <p>Note: If a session times out, refresh the browser page and login to a new web session. If you close the browser without logging off the SLB unit first, you will have to wait for the timeout time to expire. You can also end a web session by using the admin web terminate command at the CLI or by asking your system administrator to terminate your active web session.</p> <ul style="list-style-type: none"> ➤ To view or terminate current web sessions, click the Web Sessions link. ➤ To view, import, or reset the SSL Certificate, click the SSL Certificate link.
Enable TLS v1.0 Protocol	By default, the web supports the TLS v1.0 protocol. Uncheck this to disable the TLS v1.0 protocol. Changing this option requires a reboot or restarting the web server with the CLI command "admin web restart" for the change to take effect.
Enable TLS v1.1 Protocol	By default, the web supports the TLS v1.1 protocol. Uncheck this to disable the TLS v1.1 protocol. Changing this option requires a reboot or restarting the web server with the CLI command "admin web restart" for the change to take effect.
Cipher	Click one of the radio buttons to configure the web to support low security (less than 128 bits) or High/Medium security (128 bits or higher) for the cipher. By default, the web uses High/Medium. Changing this option requires a reboot for the change to take effect.

Use only SHA2 and Higher Ciphers	By default, the web supports SHA1 as well as SHA2 and higher ciphers. Check this option to support only SHA2 and higher ciphers. Changing this option requires a reboot or restarting the web server with the CLI command "admin web restart" for the change to take effect.
Group Access	If undefined, any group can access the web. If one or more groups are specified (groups are delimited by the characters ',' (comma) or ';' (semicolon)), then any user who logs into the web must be a member of one of the specified groups, otherwise access will be denied. Users authenticated via RADIUS may have a group (or groups) provided by the RADIUS server via the Filter-Id attribute that overrides the group defined for a user on the SLB branch office manager. A group provided by a remote server must be either a single group or multiple groups delimited by the characters ',' (comma), ';' (semicolon), or '=' (equals) - for example "group=group1,group2;" or "group1,group2,group3".
Banner	The text to display on the web manager home page after the user logs in. May contain up to 1024 characters (single quote and double quote characters are not supported). Blank by default. <i>Note: To create additional lines in the banner use the \n character sequence.</i>
Network Interfaces	The interfaces that the web server is available on. By default, Eth1, Eth2 and PPP interfaces on modems are enabled.
Run Web Server	If enabled, the web server will run and listen on TCP ports 80 and 443 (all requests to port 80 are redirected to port 443). By default, the web server is enabled.
Web Sessions	Click the Web Sessions link to view or terminate a web session. (See Services - Web Sessions on page 102.)
SSL Certificate	Click the SSL Certificate link to view, import or reset the SSL Certificate. (See Services - SSL Certificate on page 103.)

3. Click the **Apply** button to save.

Administrative Commands

Go to [Administrative Commands \(on page 255\)](#) to view CLI commands which correspond to the web page entries described above.

Services - Web Sessions

The [Services > Web Server](#) page enables you to view and terminate current web sessions.

To view or terminate current web sessions:

1. On the **Services** tab, click the **Web Server** page and click the **Web Sessions** link to the right. The following page displays:

Figure 7-11 Web Sessions

LANTRONIX® SLB882/8824

Logout Host: slbdb40 User: sysadmin

Select port for Configuration WebSSH (DP only) Connected Device (DP only)

Network Services User Authentication Devices Maintenance Quick Setup

SSH/Telnet/Logging SNMP NFS/CIFS Secure Lantronix Network Date & Time Web Server

Web Server - Web Sessions Help?

< Back to Web Server

Current Web Sessions				Terminate
Id	User	Login Time	Idle Time	
1	sysadmin	07/25/14 00:02	0:00:00:00	<input type="checkbox"/>

- To terminate, select the check box for the session and click **Terminate**.
- To return to the [Services > Web Server](#) page, click the **Back to Web Server** link.

Services - SSL Certificate

The [Services > Web Server](#) page enables you to view and update SSL certificate information. The SSL certificate, consisting of a public/private key pair used to encrypt HTTP data, is associated with the web server. You can import a site-specific SSL certificate or generate a custom certificate, if desired.

To view, reset, import, or change an SSL Certificate:

- On the **Services** tab, click the **Web Server** page and click the **SSL Certificate** link. The following page displays the current SSL certificate.

Figure 7-12 SSL Certificate

LANTRONIX[®] SLB882/8824

Logout Host: slb02fe User: sysadmin

Select port for Configuration WebSSH (DP only) Connected Device (DP only)

Network Services **User Authentication** Devices Maintenance Quick Setup

SSH/Telnet/Logging SNMP NFS/CIFS Secure Lantronix Network Date & Time Web Server

Web Server - SSL Certificate Help ?

Current SSL Certificate (Default)

```

Certificate:
  Data:
    Version: 1 (0x0)
    Serial Number:
      dd:2e:fe:b8:9f:06:0c:56
    Signature Algorithm: sha256WithRSAEncryption
    Issuer: C=US, ST=California, L=Irvine, O=Lantronix, CN=SLC
    Validity
      Not Before: Jun  6 14:09:05 2016 GMT
      Not After : Jun  4 14:09:05 2026 GMT
    Subject: C=US, ST=California, L=Irvine, O=Lantronix, CN=SLC
    Subject Public Key Info:
      Public Key Algorithm: rsaEncryption
      Public-Key: (2048 bit)
  
```

Reset to Default Certificate:

Note: changing the SSL Certificate requires a reboot or restarting the web server for the update to take effect.

Import SSL Certificate:

Generate custom self-signed SSL Certificate:

Import via: SCP

Certificate Filename: [Upload File](#)

Key Filename: [Upload File](#)

Passphrase:

Retype Passphrase:

Host:

Login:

Path:

Password:

Retype Password:

Number of Bits: 2048

Number of Days:

Country Name:

State or Province Name:

Locality Name:

Organization Name:

Organization Unit Name:

Hostname or Common Name:

Email Address:

Optional Challenge Password:

Retype Password:

[Back to Web Server](#)

2. If desired, enter the following:

Reset to Default Certificate	To reset to the default certificate, select the checkbox to reset to the default certificate. Unselected by default.
Import SSL Certificate	To import your own SSL Certificate, select the checkbox. Unselected by default.
Import via	From the drop-down list, select the method of importing the certificate (SCP or SFTP). The default is SCP .
Certificate Filename	Filename of the certificate. If HTTPS is selected as the method for import, the Upload File link will be selectable to upload a certificate file.
Key Filename	Filename of the private key for the certificate. HTTPS is selected as the method for import, the Upload File link will be selectable to upload a key file.

Passphrase/ Retype Passphrase	Enter the passphrase associated with the imported SSL certificate if the private key is encrypted.
Host	Host name or IP address of the host from which to import the file.
Login	User ID to use to SCP or SFTP the file.
Path	Path of the directory where the certificate will be stored.
Password / Retype Password	Password to use to SCP or SFTP the file.
Generate custom self-signed SSL Certificate	To generate your own custom self-signed certificate with attributes specific to your site, select the checkbox. Unselected by default.
Number of Bits	The number of bits to use when generating the certificate: 2048, 3072 or 4096. The default is 2048.
Number of Days	The number of days that the certificate can be used before it expires, up to 7500 days.
Country Name	The two letter country code for the custom certificate, e.g. "US" or "FR".
State or Province Name	The state or province for the custom certificate, e.g. "California". Must be at least 2 characters long.
Locality Name	The locality or city for the custom certificate, e.g. "Los Angeles". Must be at least 2 characters long.
Organization Name	The organization or company name for the custom certificate, e.g. "Lantronix". Must be at least 2 characters long.
Organization Unit Name	The unit name for the custom certificate, e.g. "Engineering" or "Sales". Must be at least 2 characters long.
Hostname or Common Name	The hostname or other name associated with the SLB the certificate is generated on, e.g., "slb100.engineering.lantronix.com". Must be at least 2 characters long.
Email Address	An optional email address to associate with the custom certificate.
Optional Challenge Password/Retype Password	An optional password use to encrypt the custom certificate.

3. Click the **Apply** button.

Note: You must reboot the SLB branch office manager for the update to take effect.

4. To return to the [Services > Web Server](#) page, click the **Back to Web Server** link.

SSL Certificate Commands

Go to [Administrative Commands \(on page 255\)](#) to view CLI commands which correspond to the web page entries described above.

ConsoleFlow

ConsoleFlow is a cloud or on-premise portal for the centralized management of multiple SLB or SLC8000 devices. A browser based interface (including mobile phone app support) allows an administrator to view status, send commands, view logs and charts and update firmware for an SLC 8000 or SLB. Each SLC or SLB can communicate with the cloud server or on-premise server, sending status updates, responding to commands sent by the server.

The online user guide for the ConsoleFlow server browser based interface is available at <https://docs.lantronix.com/products/consoleflow/web/>.

An SLB device requires a unique Device ID to communicate with the ConsoleFlow portal. The ID is viewable in the ConsoleFlow settings. If a device is not already pre-configured with the ID, the ID must be provisioned using Lantronix Provisioning Manager (LPM). See the *Provisioning Manager User Guide* at <https://www.lantronix.com/resources/product-index/>.

The ConsoleFlow client follows a sequence of steps to connect to the cloud or on-premise ConsoleFlow server, send status updates, check for firmware and configuration updates, and respond to commands from the server. This series of steps is the same each time the client starts - at SLB boot, or if the client is enabled.

1. Registration

The client will attempt to register to the **Registration Host** using the Project Tag and Device ID. If registration fails, the client will wait 30 seconds and retry. The client will retry until it is successful, or the client is disabled. Registration may fail if the Project Tag is invalid, the Device ID is invalid, the Registration Host name cannot be resolved, or the Registration Host is not reachable. Once registration is successful, **Status of Client** will display **Registered** with the date and time of registration. Note that the Registered date/time displayed in the SLC or SLB status may be different from the registered date/time shown in the ConsoleFlow web UI. The SLC or SLB registered date/time is the most recent date and time that the SLC or SLB registered with the ConsoleFlow server. The registered date and time shown in the ConsoleFlow web UI is the first time that the SLC or SLB ever registered with the ConsoleFlow server.

2. Telemetry

After registration, the client will connect to the Telemetry Host (the hostname is provided during registration) and perform a telemetry handshake. This handshake may request that the client publish a set of statistics at regular intervals. If a telemetry handshake is successful, **Status of Client** will display **Telemetry Handshake** with the date and time of the handshake. Each time telemetry statistics are published, **Status of Client** will display **Telemetry Statistics** with the date and time the statistics were sent.

3. Messages and Status Updates

After the telemetry handshake, the client will connect to the **Messaging Host** to receive messages and publish status updates. If the connection fails, the client will wait 5 seconds and retry. The connection may fail if the Messaging Host name cannot be resolved, or the Messaging Host is not reachable. Once the connection is successful, Status of Client will display Messaging connected with the date and time the connection was established.

The client publishes status update messages (changes to device attributes) at the interval defined by Interval between Status Updates. Each time a status update is published, **Status of Client** will display **Status** with the date and time the status was sent. The client also accepts command messages from the ConsoleFlow server to perform actions, such as reboot or shutdown. Each time a message is received, **Status of Client** will display **Message received** with the date and time the message was received.

4. Firmware and Configuration Updates

The client checks for firmware and configuration updates at the interval defined by Interval between FW and Config Checks. When the client checks for firmware or configuration updates, Status of Client will display Checked for Content with the date and time the check was performed. If a firmware update is found, it will be applied to the alternate (non-active) boot bank, and Status of Client will display Firmware updated with the date and time the firmware was updated. If a configuration update is found, it will be applied to the current boot bank, and Status of Client will display Configuration restored with the date and time the configuration was restored.

To configure ConsoleFlow settings:

1. Click the **Services** tab and select the **ConsoleFlow** option. The following page displays.

Figure 7-13 Services > ConsoleFlow

The screenshot shows the Lantronix SLB882/8824 web interface. The top navigation bar includes tabs for Network, Services, User Authentication, Devices, Maintenance, and Quick Setup. The Services tab is active, and the ConsoleFlow option is selected. The page title is "ConsoleFlow" with a Help icon. The configuration page includes the following fields and options:

- ConsoleFlow Client:
- Interval between status updates: 2 minutes
- Interval between FW and Config checks: 24 hours
- Firmware Updates via ConsoleFlow:
- Configuration Updates via ConsoleFlow:
- Reboot after Firmware Update:
- Device Name: SLB_2056
- Device Description: Secure Lantronix Branch Office
- Device ID: 00204ART3KJM4F6IVQXXSTE7O3Y3E
- S/N: 0080A3C32056
- Remote Access CLI Timeout: 600 seconds
- Registration Host: api.consoleflow.com
- Registration Port: 443
- Use HTTPS for registration:
- Validate certificates with HTTPS:
- Messaging Services:
- Messaging Host: mqtt.consoleflow.com
- Messaging Port: 443
- Messaging Services Security:
- Remote Access Device Port Timeout: 600 seconds

An "Apply" button is located at the bottom of the configuration section.

ConsoleFlow Status:

```
Status of Client: running
Status of Web Control: running (connected to server)
Initialized at: 03/08/19 03:51
Registered at: 03/08/19 03:51
Telemetry Handshake at: 03/08/19 03:51
Messaging connected at: 03/08/19 03:51
Custom script started at: 03/08/19 14:29
Telemetry Statistics sent at: 03/08/19 18:06
Message received at: 03/08/19 18:06
Checked for Content at: 03/13/19 03:51
Status sent at: 03/13/19 23:57
```

Script ID	Name	Device	Status
e34345b3-63ea...	getdevicetemp	DP1	Complete
1fcfd43b-1039...	temperature	CLI	Complete
5e031f2b-722d...	scr10argsdelay	CLI	Scheduled 03/14 00:52
4d40c355-d6ca...	expect	CLI	Complete
0de37412-9e49...	expect	DP1	Complete

2. Enter the following:

ConsoleFlow Client	Enables or disables the ConsoleFlow client. This option is enabled by default, unless an SLB is not configured with a Device ID. When the client is enabled, it will attempt to register with the Registration Host . If this is successful, the client will attempt to establish a connection with the Messaging Host . The General log (see SSH/Telnet/Logging on page 85) will contain messages about connections made to the Registration Host and Messaging Host. Status of Client displays the last time of actions performed by the client. Note that when the client is disabled, it may take as long as 30 seconds for the client to terminate, depending on what actions the client was performing at the time it was disabled.
Interval between status updates	Number of minutes between status updates sent from the client to the server. Valid values are 1 - 60 minutes. The default is 2 minutes.
Interval between FW and Config Checks	Number of hours between checks for firmware and configuration updates initiated by the server. Valid values are 1 - 72 hours. The default is 24 hours.
Firmware Updates via ConsoleFlow	If enabled, firmware updates can be initiated by ConsoleFlow for the SLB. The device will check for updates per the frequency defined by Interval between FW and Config Checks, and if a firmware update is found, the update will be downloaded to the device and applied to the alternate boot bank. Enabled by default.
Configuration Updates via ConsoleFlow	If enabled, configuration updates can be initiated by ConsoleFlow for the SLB. The device will check for updates per the frequency defined by Interval between FW and Config Checks, and if a configuration update is found, the update will be downloaded to the device and applied to the current boot bank, and the SLB will be immediately rebooted. Enabled by default.
Reboot after Firmware Update	If enabled, the SLB will automatically reboot after a successful firmware update via ConsoleFlow. Disabled by default.

Device Attributes

Device Name	The device name displayed in the ConsoleFlow server UI. Valid characters are alphanumeric characters, dash "-", and underscore "_". The default is the device type (SLB) with the last 4 characters of the Eth1 MAC address appended.
Device Description	Long description that is displayed in the ConsoleFlow server UI.
Device ID	The unique device identifier. The ID is 32 alphanumeric characters. The ID may be provisioned using Lantronix Provisioning Manager (LPM). Contact Lantronix Tech Support for more information on LPM.
S/N	Displays the serial number.

Registration Host

Registration Host	Hostname of the server the client registers with. The Host Name should start with api.
Registration Port	The TCP port on the Registration Host. Defaults to 443.
Use HTTPS for registration	If enabled, HTTPS (instead of HTTP) is used for registration. Enabled by default.
Validate certificates with HTTPS	If enabled, use a certificate authority to validate the HTTPS certificate. A certificate authority file can be uploaded on the Web Server page. Disabled by default.

Messaging Host

Messaging Services	If enabled, messaging services are used for status updates and commands. Enabled by default.
Messaging Host	Hostname of the server used for messaging services. The hostname should start with mqtt.
Messaging Port	The TCP port on the Messaging Host. Defaults to 443.
Messaging Services Security	If enabled, TLS is used for messaging. If Validate certificates with HTTPS is enabled for the Registration Host, a certificate authority will be used to validate the HTTPS certificates used for TLS. Enabled by default.

Remote Access Idle Timeout

Remote Access CLI Timeout	Remote Access CLI Connection will be idle timed out after a specified number of seconds as defined in the Seconds field to the right. Enter a value from 1 to 1800 seconds. The default is 600 seconds.
Remote Access Device Port Timeout	Remote Access Device Port Connection will be idle timed out after a specified number of seconds as defined in the Seconds field to the right. Enter a value from 1 to 1800 seconds. The default is 600 seconds.

3. To save, click **Apply**.

ConsoleFlow Commands

Go to [ConsoleFlow Commands \(on page 268\)](#) to view CLI commands which correspond to the web page entries described above.

8: Device Ports

This chapter describes how to configure and use an SLB device port connected to an external device, such as a server or a modem. The next chapter, [Chapter 10: Connections](#) describes how to use the [Devices > Connections](#) web page to connect external devices and outbound network connections (such as Telnet or SSH) in various configurations. The [Devices > Console Port](#) page allows you to configure the console port, if desired.

Connection Methods

A user can connect to a device port in one of the following ways:

1. Telnet or SSH to the Eth1 or Eth2 IP address, or connect to the console port, and log in to the command line interface. At the command line interface, issue the connect direct or connect listen commands.
2. If Telnet is enabled for a device port, Telnet to <Eth1 IP address>:<telnet port number> or <Eth2 IP address>:<telnet port number>, where telnet port number is uniquely assigned for each device port.
3. If SSH is enabled for a device port, SSH to <Eth1 IP address>:<ssh port number> or <Eth2 IP address>:<ssh port number>, where ssh port number is uniquely assigned for each device port.
4. If TCP is enabled for a device port, establish a raw TCP connection to <Eth1 IP address>:<tcp port number> or <Eth2 IP address>:<tcp port number>, where tcp port number is uniquely assigned for each device port.
5. If a device port has an IP address assigned to it, you can Telnet, SSH, or establish a raw TCP connection to the IP address. For Telnet and SSH, use the default TCP port number (23 and 22, respectively) to connect to the device port. For raw TCP, use the TCP port number defined for TCP In to the device port according to the [Device Ports - Settings \(on page 113\)](#) section.
6. Connect a terminal or a terminal emulation program directly to the device port. If logins are enabled, the user is prompted for a username and password and logs in to the command line interface.

For #2, #3, #4, #5, and #6, if logins or authentication are not enabled, the user is directly connected to the device port with no authentication.

For #1 and #6, if logins are enabled, the user is authenticated first, and then logged into the command line interface. The user login determines permissions for accessing device ports.

Permissions

There are three types of permissions:

1. **Direct (or data) mode:** The user can interact with and monitor the device port (connect direct command).
2. **Listen mode:** The user can only monitor the device port (connect listen command).
3. **Clear mode:** The user can clear the contents of the device port buffer (set locallog <port> clear buffer command).

The administrator and users with local user rights may assign individual port permissions to local users. The administrator and users with remote authentication rights assign port access to users authenticated by NIS, RADIUS, LDAP, Kerberos and TACACS+.

Device Status

The [Devices > Device Status](#) page displays the status of the SLB's ports, USB port and power outlets.

1. Click the **Devices** tab and select the **Device Status** option. The following page displays:

Figure 8-1 Devices > Device Status

The screenshot shows the LANTRONIX SLB882/8824 web interface. At the top, there is a navigation bar with tabs for Network, Services, User Authentication, **Devices**, Maintenance, and Quick Setup. Below this is a sub-menu with options: Device Status, Device Ports, Console Port, USB, Power Outlets, Connections, Host Lists, Scripts, and Sites. The 'Device Status' page is active, showing a 'Console Port: Connected' status. The main content area contains three tables:

Device Port Status and Counters					
No	Name	DSR	Bytes Input/Output	Errors	Connection Status
1	Port-1	Yes	0/0	0	Idle
2	Port-2	Yes	0/0	0	Idle
3	Port-3	Yes	0/0	0	Idle
4	Port-4	Yes	0/0	0	Idle
5	Port-5	Yes	0/0	0	Idle
6	Port-6	Yes	0/0	0	Idle
7	Port-7	No	0/0	0	Idle
8	Port-8	No	0/0	0	Idle

USB Ports			
Port	Device	Type	State
U1	modem	Manufacturer=U.S.Robotics Product=USB Modem SerialNumber=0000003	inserted
U2	modem	Internal	N/A

Power Outlets		
Outlet	Name	State
P1	PowerOutlet-1	Off
P2	PowerOutlet-2	Off
P3	PowerOutlet-3	Off
P4	PowerOutlet-4	Off
P5	PowerOutlet-5	Off
P6	PowerOutlet-6	Off
P7	PowerOutlet-7	Off
P8	PowerOutlet-8	Off

Global Port Settings

On the [Devices > Device Ports](#) page, you can set up the numbering of Telnet, SSH, and TCP ports, view a summary of current port modes, establish the maximum number of direct connections for each device port, and select individual ports to configure.

1. Click the **Devices** tab and select the **Device Ports** option. The following page displays:

Figure 8-2 Devices > Device Ports

LANTRONIX® SLB882/8824

Logout Host: slbdb40 User: sysadmin

Select port for Configuration WebSSH (DP only) Connected Device (DP only)

Network Services User Authentication **Devices** Maintenance Quick Setup

Device Status Device Ports Console Port USB Power Outlets Connections Host Lists Scripts Sites

Device Ports Help?

Telnet/SSH/TCP In Port Numbers
Renumber the Telnet In, SSH In or TCP In Port Number for all Device Ports.

Starting Telnet Port:

Starting SSH Port:

Starting TCP Port:

Ports: Configure			
No	Name	Mode	Select
1	Port-1	Idle	<input type="radio"/>
2	Port-2	Idle	<input type="radio"/>
3	Port-3	Idle	<input type="radio"/>
4	Port-4	Idle	<input type="radio"/>
5	Port-5	Idle	<input type="radio"/>
6	Port-6	Idle	<input type="radio"/>
7	Port-7	Idle	<input type="radio"/>
8	Port-8	Idle	<input type="radio"/>

Current port numbering schemes for Telnet, SSH, and TCP ports display on the left. The list of ports 1-8 on the right includes the individual ports and their current mode.

Note: For units with more ports, click the buttons above the table to view additional ports.

Icons that represent some of the possible modes include:

	The port is not in use.
	The port is in data/text mode. Note: You may set up ports to allow Telnet access using the IP Setting per Device Ports - Settings (on page 113) .
	An external modem is connected to the port. The user may dial into or out of the port.
	Telnet in or SSH in is enabled for the device port. The device port is either waiting for a Telnet or SSH login or has received a Telnet or SSH login (a user has logged in).

To set up Telnet, SSH, and TCP port numbering:

1. Enter the following:

Telnet/SSH/TCP in Port Numbers

Starting Telnet Port	Each port is assigned a number for connecting via Telnet. Enter a number (1025-65528) that represents the first port. The default is 2000 plus the port number. For example, if you enter 2001, subsequent ports are automatically assigned numbers 2002, 2003, and so on.
Starting SSH Port	Each port is assigned a number for connecting via SSH. Enter a number (1025-65528) that represents the first port. The default is 3000 plus the port number. For example, if you enter 3001, subsequent ports are automatically assigned numbers 3002, 3003, and so on.

Starting TCP Port	<p>Each port is assigned a number for connecting through a raw TCP connection. Enter a number (1025-65528) that represents the first port. The default is 4000 plus the port number. For example, if you enter 4001, subsequent ports are automatically numbered 4002, 4003, and so on.</p> <p>You can use a raw TCP connection in situations where a TCP/IP connection is to communicate with a serial device. For example, you can connect a serial printer to a device port and use a raw TCP connection to spool print jobs to the printer over the network.</p> <p>Note: When using raw TCP connections to transmit binary data, or where the break command (escape sequence) is not required, set the Break Sequence of the respective device port to null (clear it).</p>
--------------------------	---

Caution: Ports 1-1024 are RFC-assigned and may conflict with services running on the SLB. Avoid this range.

- Click the **Apply** button to save the settings.

To set limits on direct connections:

- Enter the maximum number (1-10) of simultaneous direct connections for each device port. The default is 1.
- Click the **Apply** button to save the settings.

To configure a specific port:

- You have two options:
 - Select the port from the ports list and click the **Configure** button. The [Device Ports > Settings](#) page for the port displays.
 - Click the port number on the green bar at the top of each page.
- Continue with directions in the section, [Device Ports - Settings \(on page 113\)](#).

Global Commands

Go to [Global Commands \(on page 300\)](#) to view CLI commands which correspond to the web page entries described above.

Device Ports - Settings

On the [Device Ports > Settings](#) page, configure IP and data (serial) settings for individual ports, and if the port connects to an external modem, modem settings as well.

To open the Device Ports - Settings page:

- You have two options:
 - In the [Devices > Device Ports](#) page (described in the previous section), select the port from the ports list and click the **Configure** button.
 - Click the desired port number in the green bar ([Figure 8-3](#)) at the top of any page, and the following page appears:

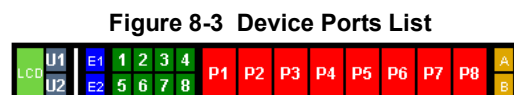

Figure 8-4 Device Ports > Settings

LANTRONIX[®] SLB882/8824

Logout Host: slb02fe User: sysadmin Select port for Configuration WebSSH (DP only) Connected Device (DP only)

Network Services User Authentication **Devices** Maintenance Quick Setup

Device Status Device Ports Console Port USB Power Outlets Connections Host Lists Scripts Sites

Device Ports - Settings Help ?

Port: 2 Logging: [Settings](#)
 Mode: Idle Connected to: undefined [Device Commands](#)

Name: Port-2

Group Access:

Banner:

Break Sequence: x1bB
Note: remove Break Sequence for Device Ports connected to raw binary connections.

View Port Log Seq: x1bV

View Port Log:

Zero Port Counters:

IP Settings

Telnet In: Port: 2002 Authentication: Timeout: Seconds: 600

SSH In: Port: 3002 Authentication: Timeout: Seconds: 600

TCP In: Port: 4002 Authentication: Timeout: Seconds: 600

IP Address/Netmask Bits:

Data Settings

Baud: 9600

Data Bits: 8

Stop Bits: 1

Parity: none

Flow Control: none

Enable Logins:

Max Direct Connects: 1

Show Lines On Connecting: No Yes, # of lines: 24

Hardware Signal Triggers

Check DSR on Connect:

Disconnect on DSR:

Modem Settings [View Modem Log](#)

State: Disabled

Mode: Text PPP

Use Sites:

Initialization Script:

Modem Timeout: No Yes, seconds (1-9999):

Caller ID Logging: Modem Command:

Dial-back Number: Local User Number Fixed Number:

Dial-back Delay: 15 seconds

Dial-back Retries: 3

Text Mode

Timeout Logins: No Yes, minutes (1-30):

Dial-in Host List: undefined [Host Lists](#)

PPP Mode

Yes No Local IP:

Negotiate IP Address: No Remote IP:

Authentication: PAP CHAP

CHAP Handshake: Host/User Name:
 Secret/User Password:

CHAP Auth Uses: CHAP Host Local Users

Same authentication for Dial-in & Dial-on-Demand (DOD):

DOD Authentication: PAP CHAP

DOD CHAP Handshake: Host/User Name:
 Secret/User Password:

Enable NAT: **Note:** Enabling NAT requires [IP Forwarding](#) to be enabled.

Dial-out Number:

Remote/Dial-out Login:

Remote/Dial-out Password: Retype:

Restart Delay: 30 seconds

CBCP Server

Allow No Callback:

CBCP Client Type: Admin-defined Number User-defined Number

Apply Settings: none to Device Ports:

Note: In addition to applying settings to the currently selected Device Port, all or some of the settings can also be applied to other Device Ports.

Port Status and Counters	
DSR/CD	No
DTR	Yes
CTS	No
RTS	Yes
Bytes input	0
Bytes output	0
Framing errors	0
Parity errors	0
Overrun errors	0
Flow Control errors	0
Seconds since zeroed	20715

[Back to Device Ports](#)

2. Enter the following:

Device Port Settings

Port	Displays number of port; displays automatically.
Mode	The status of the port; displays automatically.
Name	The name of the port. Valid characters are letters, numbers, dashes (-), periods, and underscores (_).
Group Access	If undefined, any group can access the device port. If one or more groups are specified (groups are delimited by the characters ' ' (space), ',' (comma), or ';' (semicolon)), then any user who logs into the device port must be a member of one of the specified groups, otherwise access will be denied. Users authenticated via RADIUS may have a group (or groups) provided by the RADIUS server via the Filter-Id attribute that overrides the group defined for a user on the SLB. A group provided by a remote server must be either a single group or multiple groups delimited by the characters ' ' (space), ',' (comma), ';' (semicolon), or '=' (equals) - for example "group=group1,group2;" or "group1,group2,group3".
Banner	Text to display when a user connects to a device port by means of Connect Direct (CLI), Telnet, SSH, or TCP. If authentication is enabled for the device port, the banner displays once the user successfully logs in. May contain up to 1024 characters (single quote and double quote characters are not supported). Blank by default.
Break Sequence	A series of one to ten characters users can enter on the command line interface to send a break signal to the external device. A suggested value is Esc+B (escape key, then uppercase "B" performed quickly but not simultaneously). You would specify this value as x1bB , which is hexadecimal (x) character 27 (1B) followed by a B .
View Port Log Seq	The key sequence used to view the Port Log while in Connect Direct mode. Non-printing characters can be specified by giving their hexadecimal code (see Break Sequence above). The default is Esc+V (x1bV).
View Port Log	Select to allow the user to enter the View Port Log Sequence to view the Port Log during Connect Direct mode. The default is disabled.
Zero Port Counters	Resets all of the numerical values in the Port Counters table at the bottom of the page to zero (0).
Logging	Click the Settings link to configure file logging, email logging, and local logging.
Connected to	The type of device connected to the device port. Presently, the SLB branch office manager supports Lantronix SLP power managers (SLP8 and SLP16 units) and Sensorsoft devices. If the type of device is not listed, select undefined . If you select anything other than undefined , click Device Commands . The appropriate web page displays. If you select SLP or ServerTech CDU and click Device Commands, the Device Ports > SLP web page displays. If you select Sensorsoft and click Device Comands, the Devices > Device Ports > Sensorsoft web page displays.

IP Settings

Telnet In	Enables access to this port through Telnet. Disabled by default.
SSH In	Enables access to this port through SSH. Disabled by default.

TCP in	Enables access to this port through a raw TCP connection. Disabled by default: Note: When using raw TCP connections to transmit binary data, or where the break command (escape sequence) is not required, set the Break Sequence of the respective device port to null (clear it).
Port	Automatically assigned Telnet, SSH, and TCP port numbers. You may override this value, if desired.
Authentication	If selected, the SLB branch office manager requires user authentication before granting access to the port. Authenticate is selected by default for Telnet in and SSH in , but not for TCP in .
Timeout	To cause an idle Telnet, SSH or TCP connection to disconnect after a specified number of seconds, select the checkbox and enter a value from 1 to 1800 seconds. The default is no timeout.
Seconds	Number of seconds before a timeout.
IP Address/Netmask Bits	IP address used for this device port so a user can Telnet, SSH, or establish a raw TCP connection to this address and connect directly to the device port. The optional netmask bits specify the netmask to use for the IP address. For example, for a netmask of 255.255.255.0 specify 24 bits. If the netmask bits are not specified, a default netmask used for the class of network that the IP address falls in will be used. For Telnet and SSH, the default TCP port numbers (22 and 23, respectively) are used to connect to the device port. For raw TCP, the TCP port number defined for TCP In to the device port is used. Note: If Ethernet Bonding is enabled, assigning individual IP Addresses to Device Ports is not supported. Note that the IP address will be bound to Eth1 only, so if Eth2 is connected and configured, and Eth1 is not, this feature will not work.

Data Settings

Note: Check the serial device's equipment settings and documentation for the proper settings. The device port and the attached serial device must have the same settings.

Baud	The speed with which the device port exchanges data with the attached serial device. From the drop-down list, select the baud rate. Most devices use 9600 for the administration port, so the device port defaults to this value. Check the equipment settings and documentation for the proper baud rate.
Data Bits	Number of data bits used to transmit a character. From the drop-down list, select the number of data bits. The default is 8 data bits.
Stop Bits	The number of stop bit(s) used to indicate that a byte of data has been transmitted. From the drop-down list, select the number of stop bits. The default is 1.
Parity	Parity checking is a rudimentary method of detecting simple, single-bit errors. From the drop-down list, select the parity. The default is none .
Flow Control	A method of preventing buffer overflow and loss of data. The available methods include none, xon/xoff (software), and RTS/CTS (hardware). The default is none .
Enable Logins	For serial devices connected to the device port, displays a login prompt and authenticates users. Successfully authenticated users are logged into the command line interface. The default is disabled. This is the correct setting if the device port is the endpoint for a network connection.

Max Direct Connects	Enter the maximum number (1-10) of simultaneous connections for the device port. The default is 1.
Show Lines on Connecting	<p>If enabled, when the user either does a connect direct from the CLI or connects directly to the port using Telnet or SSH, the SLB outputs up to 24 lines of buffered data as soon as the serial port is connected.</p> <p>For example, an SLB user issues a <code>connect direct device 1</code> command to connect port 1 to a Linux server.</p> <p>Then the SLB user is command to display a directory on the Linux server, then exits the connection. When the SLB user issues another <code>direct connect device 1</code>, the last 24 lines of the <code>ls</code> command is displayed so the user can see what state the server was left in.</p>

Hardware Signal Triggers

Check DSR on Connect	If this setting is enabled, the device port only establishes a connection if DSR (Data Set Ready) is in an asserted state. DSR should already be in an asserted state, not transitioning to, when a connection attempt is made. Disabled by default unless dial-in, dial-out, or dial-back is enabled for the device port.
Disconnect on DSR	If a connection to a device port is currently in session, and the DSR signal transitions to a de-asserted state, the connection disconnects immediately. Disabled is the default unless dial-in, dial-out, or dial-back is enabled for the device port.

Modem Settings

Note: Depending on the **State** and **Mode** you select, different fields are available.

State	Indicates whether an external modem is attached to the device port. If enabling, set the modem to dial-out, dial-in, dial-back, dial-on-demand, dial-in/host list, or dial in & dial-on-demand. Disabled by default. For more information on the different dialing types, see Modem Dialing States .
Mode	<p>The format in which the data flows back and forth:</p> <ul style="list-style-type: none"> ◆ Text: In this mode, the SLB branch office manager assumes that the modem will be used for remotely logging into the command line. Text mode can only be used for dialing in or dialing back. Text is the default. ◆ PPP: This mode establishes an IP-based link over the modem. PPP connections can be used in dial-out mode (e.g., the SLB unit connects to an external network), dial-in mode (e.g., the external computer connects to the network that the SLB device is part of), dial-back (dial-in followed by dial-out), dial-on-demand, CBCP server or CBCP client.
Use Sites	Enables the use of site-oriented modem parameters which can be activated by various modem-related events (authentication, outbound network traffic for dial-on-demand connections, etc.). Sites can be used with the following modem states: dial-in, dial-back, dial-on-demand, dial-in & dial-on-demand, dial-back & dial-on-demand, and CBCP server. For more information, see Sites (on page 165) .

Initialization Script	<p>Commands sent to configure the modem may have up to 100 characters. Consult your modem's documentation for recommended initialization options. If you do not specify an initialization script, the SLB branch office manager uses a default initialization string of</p> <pre>AT S7=45 SO=0 L1 V1 X4 &D2 &c1 E1 Q0.</pre> <p>Note: We recommend that the modem initialization script always be preceded with <code>AT</code> and include <code>E1 V1 x4 Q0</code> so that the SLB unit may properly control the modem. For information on AT commands, refer to the modem user guide, or do a web search for <code>at command set</code>.</p>
Modem Timeout	<p>Timeout for all modem connections. Select Yes (default) for the SLB branch office manager to terminate the connection if no traffic is received during the configured idle time. Enter a value of from 1 to 9999 seconds. The default is 30 seconds.</p>
Caller ID Logging	<p>Select to enable the SLB branch office manager to log caller IDs on incoming calls. Disabled by default.</p> <p>Note: For the Caller ID AT command, refer to the modem user guide.</p>
Modem Command	<p>Modem AT command used to initiate caller ID logging by the modem.</p> <p>Note: For the AT command, refer to the modem user guide.</p>
Dial-back Number	<p>Users with dial-back access can dial into the SLB unit and enter their login and password. Once the SLB authenticates them, the modem hangs up and dials them back.</p> <p>Select the phone number the modem dials back on -a fixed number or a number associated with their login. If you select Fixed Number, enter the number (in the format 2123456789).</p> <p>The dial-back number is also used for CBCP client as the number for a user-defined number. See Device Ports - Settings (on page 113) for more information.</p>
Dial-back Delay	<p>For dial-back and CBCP Server, the number of seconds between the dial-in and dial-out portions of the dialing sequence.</p>
Dial-back Retries	<p>For dial-back and CBCP Server, the number of times the SLB device will retry the dial-out portion of the dialing sequence if the first attempt to dial-out fails.</p>

Modem Settings: Text Mode

Timeout Logins	<p>If you selected Text mode, you can enable logins to time out after the connection is inactive for a specified number of minutes. The default is No. This setting is only applicable for text mode connections. PPP mode connections stay connected until either side drops the connection. Disabled by default.</p>
Dial-in Host List	<p>From the drop-down list, select the desired host list. The host list is a prioritized list of SSH, Telnet, and TCP hosts that are available for establishing outgoing modem connections or for connect direct at the CLI. The hosts in the list are cycled through until the SLB branch office manager successfully connects to one.</p> <p>To establish and configure host lists, click the Host Lists link.</p>

Modem Settings: PPP Mode

Negotiate IP Address	<p>If the SLB unit and/or the serial device have dynamic IP addresses (e.g., IP addresses assigned by a DHCP server), select Yes. Yes is the default.</p> <p>If the SLB device or the modem have fixed IP addresses, select No, and enter the Local IP (IP address of the port) and Remote IP (IP address of the modem).</p>
-----------------------------	---

Authentication	Enables PAP or CHAP authentication for modem logins. PAP is the default. With PAP, users are authenticated by means of the Local Users and any of the remote authentication methods that are enabled. With CHAP, the CHAP Handshake fields authenticate the user.
CHAP Handshake	The Host/User Name (for UNIX systems) or Secret/User Password (for Windows systems) used for CHAP authentication. May have up to 128 characters.
CHAP Auth Uses	For CHAP authentication, determines what is used to validate the CHAP host/user sent by the remote peer: either the CHAP Host defined for the modem, or any of the users in the Local Users list.
Same authentication for Dial-in & Dial-on-Demand (DOD)	Select this option to let incoming connections (dial-in) use the same authentication settings as outgoing connections (dial-on-demand). If this option is not selected, then the dial-on-demand connections take their authentication settings from the DOD parameter settings. If DOD Authentication is PAP, then the DOD CHAP Handshake field is not used.
DOD Authentication	Enables PAP or CHAP authentication for dial-in & dial-on-demand. PAP is the default. With PAP, users are authenticated by means of the Local Users and any of the remote authentication methods that are enabled. With CHAP, the DOD CHAP Handshake fields authenticate the user.
DOD CHAP Handshake	For DOD Authentication , enter the Host/User Name for UNIX systems) or Secret/User Password (for Windows systems) used for CHAP authentication. May have up to 128 characters.
Enable NAT	Select to enable Network Address Translation (NAT) for dial-in and dial-out PPP connections on a per modem (device port or USB port) basis. Users dialing into the SLB branch office manager access the network connected to Eth1 and/or Eth2. <i>Note: IP forwarding must be enabled on the Network > Network Settings (bottom of page) page for NAT to work. See Chapter 6: Basic Parameters on page 58.</i>
Dial-out Number	Phone number for dialing out to a remote system or serial device. May have up to 20 characters. Any format is acceptable.
Remote/Dial-out Login	User ID for dialing out to a remote system. May have up to 32 characters.
Remote/Dial-out Password	Password for dialing out to a remote system. May have up to 64 characters.
Retype	Re-enter remote/dial-out password for dialing out to a remote system. May have up to 64 characters.
Restart Delay	The number of seconds after the timeout and before the SLB unit attempts another connection. The default is 30 seconds.
CBCP Server Allow No Callback	For CBCP Server state, allows "No Callback" as an option in the CBCP handshake in addition to User-defined Number and Admin-defined Number.
CBCP Client Type	For CBCP Client, this selects the number that the client would like to use for callback - either a user-defined number passed to the server (specified by the Fixed Dial-back Number) or an administrator-defined number determined by the server based on the login that is PAP or CHAP authenticated.

3. To save settings for just this port, click the **Apply** button.
4. To save selected settings to ports other than the one you are configuring:
 - ◆ From the **Apply Settings** drop-down box, select none, a group of settings, or All.
 - ◆ In **to Device Ports**, type the device port numbers, separated by commas; indicate a range of port numbers with a hyphen (e.g., 2, 5, 7-10).

Note: It may take a few minutes for the system to apply the settings to multiple ports.

Port Status and Counters

Port Counters describe the status of signals and interfaces. SLB branch office manager updates and increments the port counters as signals change and data flows in and out of the system. These counters help troubleshoot connections or diagnose problems because they give the user an overview of the state of various parameters. By setting them to zero and then re-checking them later, the user can view changes in status.

The chart in the middle of the page displays the flow control lines and port statistics for the device port. The system automatically updates these values. To reset them to zeros, select the **Zero** port counters checkbox in the IP Settings section of the page.

Note: Status and statistics shown on the web interface represent a snapshot in time. To see the most recent data, you must reload the web page.

Table 8-5 Port Status and Counters

Port Status and Counters	
DSR/CD	No
DTR	Yes
CTS	No
RTS	Yes
Bytes input	0
Bytes output	0
Framing errors	0
Parity errors	0
Overrun errors	0
Flow Control errors	0
Seconds since zeroed	106734

Device Ports - SLP Units

On the [Device Ports > SLP](#) page, configure commands to send to an SLP power manager or SLP expansion chassis that expands the number of power ports.

To open the Device Ports - SLP page:

1. In the **Connected to** field above the IP Settings section of the [Device Port Settings](#) page, select an **SLP** or **SLPEXP**.
2. Click the **Device Commands** link. The following page displays:

Figure 8-6 Device Ports > SLP

Device Status Device Ports Console Port USB Power Outlets Connections Host Lists Scripts Sites

Device Ports - SLP / ServerTech CDU [Help?](#)

Port: **5**
 Name: **Port-5**
 Device: **SLP8**

Number of Outlets:
 Number of Expansion Outlets:
 Login:
 Password:
 Retype Password:
 Prompt:

Status/Info
[Outlet Status](#) > Tower A Tower B
 All Outlets
 Single Outlet:

[Environmental Status](#) >
[Infeed Status](#) >
[System Info](#) >

Commands
 Restart:
 Control Outlet: **No Action** v
 Tower A Tower B
 All Outlets
 Single Outlet:

[Back to Device Port Settings](#)

To enter SLP commands:

1. Enter the following:

Number of Outlets	Enter the number of outlets for a ServerTech CDU. This setting is not applicable for an SLP unit.
Number of Expansion Outlets	Enter the number of outlets for a ServerTech CDU expansion unit. This setting is not applicable for an SLP device.
Login	User ID for logging into the SLP power manager.
Password	Enter password for logging into the SLP unit.
Retype Password	Re-enter password for logging into the SLP power manager.
Prompt	Enter the prompt displayed by the SLP unit or ServerTech CDU device. This will default to a typical prompt for an SLP power manager or ServerTech CDU. If you are unable to control the SLP unit or ServerTech CDU device, verify that the prompt is set to the right value.

Status/Info

Outlet Status	<p>Note: If there is an SLP power manager and an SLP Expansion chassis, the SLP unit is Tower A and the Expansion chassis is Tower B.</p> <p>For Tower A or Tower B, select All Outlets or Single Outlet to view the status of all outlets or a single outlet of the SLP power manager. If you select Single Outlet, enter a value of 1-8 for the SLP8 or 1-16 for the SLP16 device.</p> <p>Click the Outlet Status link to see the status of the selected outlet(s).</p>
Environmental Status	Click the link to view the environmental status (e.g., temperature and humidity) of the SLP power manager.

Infeed Status	Click the link to view the status of the data the SLP unit is receiving.
System Info	Click the link to see system information pertaining to the SLP power manager.

Commands

Restart SLP	To restart the SLP power manager, select the checkbox.
Control Outlet	For Tower A or Tower B , select All Outlets or Single Outlet and the number of the outlet to be controlled (1-8 for the SLP8 or 1-16 for the SLP16 devices) and select the command for the outlet (No Action, Power On, Power Off, Cycle Power). No Action is the default.

2. Click the **Apply** button.

Device Port - Sensorsoft Device

Devices made by Sensorsoft are used to monitor environmental conditions.

1. In the **Connected to** field above the IP Settings section of the *Device Port Settings* page, select **Sensorsoft**.
2. Click the **Device Commands** link. The following page displays:

Figure 8-7 Devices > Device Ports > Sensorsoft

The screenshot shows the LANTRONIX SLB882/8824 web interface. At the top, there is a navigation menu with buttons for Network, Services, User Authentication, Devices, Maintenance, and Quick Setup. Below the menu, there is a section titled "Device Ports - Sensorsoft" with a "Help?" link. The main content area displays a table of "Sensorsoft Devices" with the following columns: Dev Port, Device Port Name, Temp, Low Temp, High Temp, Use °F, Humidity (%), Low Humidity, High Humidity, and Traps. The table shows one device with Dev Port 5, Device Port Name Port-5, Temp 0.0 °C, Low Temp 0, High Temp 25, Use °F checkbox, Humidity 0.0, Low Humidity 0, High Humidity 100, and Traps checkbox. Below the table, there is a "Back to Device Port Settings" link and an "Apply" button.

Dev Port	Device Port Name	Temp	Low Temp	High Temp	Use °F	Humidity (%)	Low Humidity	High Humidity	Traps
5	Port-5	0.0 °C	0	25	<input type="checkbox"/>	0.0	0	100	<input type="checkbox"/>

3. Select a port and enter or view the following information:

Dev Port	Displays the number of the SLB port.
Device Port Name	Displays the name of the SLB port.
Temp	Current temperature (degrees Celsius) on the device the sensor is monitoring.
Low Temp	Enter the temperature (degrees Celsius) permitted on the monitored device below which the SLB branch office manager sends a trap.
High Temp	Enter the temperature (degrees Celsius) permitted on the monitored device above which the SLB unit sends a trap.
Use °F	Display and set the temperature for this device in degrees Fahrenheit, instead of Celsius, which is the default.
Humidity (%)	Current relative humidity on the device the sensor is monitoring.
Low Humidity	Enter the relative humidity permitted on the device the sensor is monitoring below which the sensor sends a trap to the SLB device.

High Humidity	Enter the highest relative acceptable humidity permitted on the device above which the sensor sends a trap to the SLB branch office manager.
Traps	Select to indicate the SLB unit should send a trap or configured Event Alert when the sensor detects an out-of-range configured threshold.

- Click the **Apply** button.
- To view the status detected by the Sensorsoft, click the **Sensorsoft Status** link to the right of the table.

Device Port Commands

Go to [Device Port Commands \(on page 291\)](#) to view CLI commands which correspond to the web page entries described above.

Interacting with a Device Port

Once a device port has been configured and connected to an external device such as the console port of an external server, the data received over the device port can be monitored at the command line interface with the connect listen command, as follows:

To connect to a device port to monitor it:

```
connect listen deviceport <Port # or Name>
```

In addition, you can send data out the device port (for example, commands issued to an external server) with the connect direct command, as follows:

To connect to a device port to monitor and/or interact with it, or to establish an outbound network connection:

```
connect direct <endpoint>
```

endpoint is one of:

```
deviceport <Port # or Name>
ssh <IP Address> [port <TCP Port>] [<SSH flags>]
```

where:

```
<SSH flags> is one or more of:
user <Login Name>
version <1|2>
command <Command to Execute>
tcp <IP Address> port <TCP Port>
telnet <IP Address> [port <TCP Port>]
udp <IP Address> port <UDP Port>
hostlist <Host List>
```

Note: To escape from the connect direct command when the endpoint of the command is deviceport, tcp, or udp and return to the command line interface, type the escape sequence assigned to the currently logged in user. If the endpoint is telnet or SSH, logging out returns the user to the command line prompt.

Note: To escape from the connect listen command, press any key.

Setting up a user with an escape sequence is optional. For any NIS, LDAP, RADIUS, Kerberos, or TACACS+ user, or any local user who does not have an escape sequence defined, the default escape sequence is Esc+A.

Device Ports - Logging

The SLB products support port buffering of the data on the system's device ports as well as notification of receiving data on a device port. Port logging is disabled by default. You can enable more than one type of logging (local, NFS file, email/SNMP, or USB port) at a time. The buffer containing device port data is cleared when any type of logging is enabled.

Local Logging

If local logging is enabled, each device port stores 256 Kbytes (approximately 400 screens) of I/O data in a true FIFO buffer. You may view this data (in ASCII format) at the CLI with the `show locallog` command or on the [Devices > Device Ports - Logging](#) page. Buffered data is normally stored in RAM and is lost in the event of a power failure if it is not logged using an NFS mount solution. If the buffer data overflows the buffer capacity, only the oldest data is lost, and only in the amount of overrun (not in large blocks of memory).

NFS File Logging

Data can be logged to a file on a remote NFS server. Data logged locally to the SLB branch office manager is limited to 256 Kbytes and may be lost in the event of a power loss. Data logged to a file on an NFS server does not have these limitations. The system administrator can define the directory for saving logged data on a port-by-port basis and configure file size and number of files per port.

The directory path must be the local directory for one of the NFS mounts. For each logging file, once the file size reaches the maximum, a new file opens for logging. Once the number of files reaches the maximum, the oldest file is overwritten. The file naming convention is: <Device Port Number>_<Device Port Name>_<File number>.log.

Examples:

```
02_Port-2_1.log
02_Port-2_2.log
02_Port-2_3.log
02_Port-2_4.log
02_Port-2_5.log
```

USB Flash Drive Logging

Data can be logged to a USB flash drive that is loaded into the USB port on the front of the SLB branch office manager (see [USB Port on page 172](#)). Data logged locally to the SLB unit is limited to 256 Kbytes and may be lost in the event of a power loss. Data logged to a USB flash drive does not have these limitations. The system administrator can define the file size and number of files per port. For each logging file, once the file size reaches the maximum, a new file opens for logging. Once the number of files reaches the maximum, the oldest file is overwritten. The file naming convention is: <Device Port Number>_<Device Port Name>_<File number>.log.

Examples:

```
02_Port-2_1.log
```

02_Port-2_2.log
02_Port-2_3.log
02_Port-2_4.log
02_Port-2_5.log

Email/SNMP Notification

The system administrator can configure the SLB branch office manager to send an email alert message indicating a particular condition detected in the device port log to the appropriate parties or an SNMP trap to the designated NMS (see [Chapter 7: Services on page 84](#)). The email or trap is triggered when a user-defined number of characters in the log from your server or device is exceeded, or a specific sequence of characters is received.

Use the [Device Ports - SLP Units \(on page 120\)](#) to set logging parameters on individual ports.

Sylogs Logging

Data can be logged to the system log. If this feature is enabled, the data will appear in the Device Ports log, under the Info level. The log level for the Device Ports log must be set to Info for the data to be saved to the system log. (See [Chapter 7: Services on page 84](#).)

To set logging parameters:

1. In the top section of the [Device Port Settings](#) page, click the **Settings** link in the Logging field. The following page displays:

Figure 8-8 Devices > Device Ports - Logging

LANTRONIX® SLB882/8824

Logout Host: slbdb40 User: sysadmin

Select port for Configuration WebSSH (DP only) Connected Device (DP only)

Network Services User Authentication **Devices** Maintenance Quick Setup

Device Status Device Ports Console Port USB Power Outlets Connections Host Lists Scripts Sites

Device Ports - Logging Help?

Port: 5 Name: Port-5

For NFS File Logging, the directory to log to must reside on an external NFS server. Specify the local directory for the [NFS mount](#).

Local Logging:
 Clear Local Log: [View Local Log](#)

Email/Traps:
 Send: Email SNMP Trap Both
 Trigger on: Byte Count Text String Recognition
 Byte Threshold:
 Text String:
 Email Delay: seconds
 Restart Delay: seconds
 Email To:
 Email Subject:

Log Viewing Attributes
 Display: Tail Head
 Number of Lines:

NFS File Logging:
 NFS Log to View: [View](#)
 Directory to Log to:
 Max Number of Files:
 Max Size of Files: bytes

USB Logging:
 USB Log to View: [View](#)
 Log to: Port U1
 Max Number of Files:
 Max Size of Files: bytes

Syslog Logging:
 Note: The logging level for the Device Ports log must be set to 'Info' to view Syslog entries for Device Port logging.

Apply settings to Device Ports:

Note: In addition to applying settings to the currently selected Device Port, the settings can also be applied to other Device Ports.

[Back to Device Port Settings](#)

2. Enter the following:

Local Logging

Local Logging	If you enable local logging, each device port stores 256 Kbytes (approximately 400 screens) of I/O data in a true FIFO buffer. Disabled by default.
Clear Local Log	Select the checkbox to clear the local log.
View Local Log	Click this link to see the local log in text format.

Email/SNMP Traps

Email/Traps	Select the checkbox to enable email and SNMP logging. Email logging sends an email message to pre-defined email addresses or an SNMP trap to the designated NMS (see Chapter 7: Services on page 84) when alert criteria are met. Disabled by default.
--------------------	---

Send	<p>If you enabled email and SNMP logging, select what type of notification log to send:</p> <ul style="list-style-type: none"> ◆ Email (default) ◆ SNMP Trap ◆ Both
Trigger on	<p>Select the method of triggering a notification:</p> <ul style="list-style-type: none"> ◆ Byte Count: A specific number of bytes of data. This is the default. ◆ Text String Recognition: A specific pattern of characters, which you can define by a regular expression. <p><i>Note: Text string recognition may negatively impact the SLB device's performance, particularly when regular expressions are used.</i></p>
Byte Threshold	<p>The number of bytes of data the port receives before the SLB unit captures log data and sends a notification regarding this port. The default is 100 bytes.</p> <p>In most cases, the console port of your device does not send any data unless there is an alarm condition. After the SLB branch office manager receives a small number of bytes, it perceives that your device needs some attention. The SLB unit notifies your technician when that point has been passed, and the notification includes the logged data.</p> <p>For example, a threshold preset at 30 characters means that as soon as the SLB branch office manager receives 30 bytes of data, it captures log data and sends an email regarding this port.</p>
Text String	<p>The specific pattern of characters the SLB unit must recognize before sending a notification to the technician about this port. The maximum is 100 characters. You may use a regular expression to define the pattern. For example, the regular expression "abc[def]g" recognizes the strings abcdg, abceg, abcfg.</p> <p>The SLB device supports GNU regular expressions; for more information, see: http://www.delorie.com/gnu/docs/regex/regex.html</p>
Email Delay	<p>A time limit of how long (in seconds), after the SLB branch office manager detects the trigger, that the device port captures data before closing the log file (with a fixed internal buffer maximum capacity of 1500 bytes) and sending a notification. The default is 60 seconds.</p>
Restart Delay	<p>The number of seconds for the period after the notification has been sent during which the device port ignores additional characters received. The data is simply ignored and does not trigger additional alarms until this time elapses. The default is 60 seconds.</p>
Email to	<p>The complete email address of the message recipient(s) for each device port(s). Each device port has its own recipient list. To enter more than one email address, separate the addresses with a single space. You can enter up to 128 characters.</p>
Email Subject	<p>A subject text appropriate for your site. May have up to 128 characters.</p> <p>The email subject line is pre-defined for each port with its port number. You can use the email subject to inform the desired recipients of the problem on a certain server or location (e.g., server location or other classification of your equipment). This is helpful if the email message goes to the system administrator's or service technician's mobile or wireless device (e.g., text messaging by means of email).</p> <p><i>Note: The character sequence %d anywhere in the email subject is replaced with the device port number automatically.</i></p>

Log Viewing Attributes

Display	Select to view either the beginning (head) or end (tail) of the log.
Number of Lines	Number of lines from the head or tail of the log to display.

NFS File Logging

NFS Log to View	Select the checkbox to log all data sent to the device port to one or more files on an external NFS server. Disabled by default.
Directory to Log to	The path of the directory where the log files will be stored. <i>Note: This directory must be a directory exported from an NFS server mounted on the SLB. Specify the local directory path for the NFS mount.</i>
Max Number of Files	The maximum number of files to create to contain log data to the port. These files keep a history of the data received from the port. Once this limit is exceeded, the oldest file is overwritten. The default is 10 .
Max Size of Files	The maximum allowable file size in bytes. The default is 2048 bytes. Once the maximum size of a file is reached, the SLB unit begins generating a new file.

USB Logging

USB Log to View	Available log files in the selected USB port to view.
Log To	Select the USB port to use for logging.
Max Number of Files	The maximum number of files to create to contain log data to the port. These files keep a history of the data received from the port. Once this limit is exceeded, the oldest file is overwritten. The default is 10.
Max Size of Files	The maximum allowable file size in bytes. The default is 2048 bytes. Once the maximum size of a file is reached, the SLB branch office manager begins generating a new file. The default is 2048 bytes.

Syslog Logging

Syslog Logging	Select to enable system logging. <i>Note: The logging level for the device ports log must be set to Info to view Syslog entries for Device Port logging on the Services > SSH/Telnet/Logging page.</i>
-----------------------	--

Note: To apply the settings to additional device ports, in the *Apply settings to Device Ports* field, enter the additional ports, (e.g., 1-3, 5, 6)

- To apply settings to other device ports in addition to the currently selected port, select the **Apply settings to Device Ports** and enter port numbers separated by commas. Indicate a range of port numbers with a hyphen (e.g., 2, 5, 7-10), and separate ranges with commas.
- To save, click the **Apply** button.

Logging Commands

Go to [Logging Commands \(on page 304\)](#) to view CLI commands which correspond to the web page entries described above.

Console Port

The console port initially has the same defaults as the device ports. Use the [Devices > Console Port](#) page to change the settings, if desired.

To set console port parameters:

1. Click the **Devices** tab and select **Console Port**. The following page displays:

Figure 8-9 Devices > Console Port

The screenshot shows the LANTRONIX SLB882/8824 web interface. At the top, there is a navigation bar with tabs for Network, Services, User Authentication, **Devices**, Maintenance, and Quick Setup. Below the navigation bar, the Console Port configuration page is displayed. The status is "Connected". The configuration form includes the following fields and options:

- Baud:** 9600 (dropdown menu)
- Data Bits:** 8 (dropdown menu)
- Stop Bits:** 1 (dropdown menu)
- Parity:** none (dropdown menu)
- Flow Control:** none (dropdown menu)
- Timeout:** No Yes, minutes:
- Show Lines On Connecting:** No Yes, # of lines:
- Group Access:**

An **Apply** button is located at the bottom of the configuration form.

2. Change the following as desired:

Baud	The speed with which the device port exchanges data with the attached serial device. From the drop-down list, select the baud rate. Most devices use 9600 for the administration port, so the console port defaults to this value.
Data Bits	Number of data bits used to transmit a character. From the drop-down list, select the number of data bits. The default is 8 data bits.
Stop Bits	The number of stop bits that indicate that a byte of data has been transmitted. From the drop-down list, select the number of stop bits. The default is 1 .
Parity	Parity checking is a rudimentary method of detecting simple, single-bit errors. From the drop-down list, select the parity. The default is none .
Flow Control	A method of preventing buffer overflow and loss of data. The available methods include none, xon/xoff (software), and RTS/CTS (hardware). The default is none .
Timeout	The number of minutes (1-30) after which an idle session on the console is automatically logged out. Disabled by default.
Show Lines on Connecting	If selected, when you connect to the console port with a terminal emulator, you will see the last lines output to the console, for example, the SLB boot messages or the last lines output during a CLI session on the console.

Group Access	If undefined, any group can access the console port. If one or more groups are specified (groups are delimited by the characters ' ' (space), ',' (comma), or ';' (semicolon)), then any user who logs into the console port must be a member of one of the specified groups, otherwise access will be denied. Users authenticated via RADIUS may have a group (or groups) provided by the RADIUS server via the Filter-Id attribute that overrides the group defined for a user on the SLB. A group provided by a remote server must be either a single group or multiple groups delimited by the characters ' ' (space), ',' (comma), ';' (semicolon), or '=' (equals) - for example "group=group1,group2;" or "group1,group2,group3".
---------------------	--

3. Click the **Apply** button to save the changes.

Console Port Commands

Go to [Console Port Commands \(on page 286\)](#) to view CLI commands which correspond to the web page entries described above.

Power Outlets

The SLB branch office manager has eight outlets that can provide power to other units in an IT environment. Each outlet can be configured and controlled through the SLB unit. The SLB device can issue an SNMP trap if the total current for all eight outlets exceeds a specified threshold.

To configure a power outlet:

1. Click the **Devices** tab and select the **Power Outlets** option. The following page displays:

Note: *Clicking any of the red P1 through P8 buttons, located at the top of each page displayed, allows controlled configuration of the power outlets.*

Figure 8-10 Devices > Power Outlets

LANTRONIX® SLB882/8824

Host: slbdb40
User: sysadmin

Select port for Configuration WebSSH (DP only) Connected Device (DP only)

Logout

Network Services User Authentication **Devices** Maintenance Quick Setup

Device Status Device Ports Console Port USB Power Outlets Connections Host Lists Scripts Sites

Power Outlets Help?

Switching Delay: msec

Over Current Alarm: Off On, Threshold (1-180): Tenths of Amps

Current Level for all Outlets: **0.0** Amps

Outlet: P1	Status: Off	Power State: <input type="radio"/> On <input checked="" type="radio"/> Off
	Name: <input type="text" value="PowerOutlet-1"/>	Wakeup Mode: <input type="radio"/> On <input checked="" type="radio"/> Off <input type="radio"/> Last State
	Description: <input type="text" value="Power Outlet 1"/>	Reboot: <input type="checkbox"/>
	Current: 0.0 Amps	
Outlet: P2	Status: Off	Power State: <input type="radio"/> On <input checked="" type="radio"/> Off
	Name: <input type="text" value="PowerOutlet-2"/>	Wakeup Mode: <input type="radio"/> On <input checked="" type="radio"/> Off <input type="radio"/> Last State
	Description: <input type="text" value="Power Outlet 2"/>	Reboot: <input type="checkbox"/>
	Current: 0.0 Amps	
Outlet: P3	Status: Off	Power State: <input type="radio"/> On <input checked="" type="radio"/> Off
	Name: <input type="text" value="PowerOutlet-3"/>	Wakeup Mode: <input type="radio"/> On <input checked="" type="radio"/> Off <input type="radio"/> Last State
	Description: <input type="text" value="Power Outlet 3"/>	Reboot: <input type="checkbox"/>
	Current: 0.0 Amps	
Outlet: P4	Status: Off	Power State: <input type="radio"/> On <input checked="" type="radio"/> Off
	Name: <input type="text" value="PowerOutlet-4"/>	Wakeup Mode: <input type="radio"/> On <input checked="" type="radio"/> Off <input type="radio"/> Last State
	Description: <input type="text" value="Power Outlet 4"/>	Reboot: <input type="checkbox"/>
	Current: 0.0 Amps	
Outlet: P5	Status: Off	Power State: <input type="radio"/> On <input checked="" type="radio"/> Off
	Name: <input type="text" value="PowerOutlet-5"/>	Wakeup Mode: <input type="radio"/> On <input checked="" type="radio"/> Off <input type="radio"/> Last State
	Description: <input type="text" value="Power Outlet 5"/>	Reboot: <input type="checkbox"/>
	Current: 0.0 Amps	
Outlet: P6	Status: Off	Power State: <input type="radio"/> On <input checked="" type="radio"/> Off
	Name: <input type="text" value="PowerOutlet-6"/>	Wakeup Mode: <input type="radio"/> On <input checked="" type="radio"/> Off <input type="radio"/> Last State
	Description: <input type="text" value="Power Outlet 6"/>	Reboot: <input type="checkbox"/>
	Current: 0.0 Amps	
Outlet: P7	Status: Off	Power State: <input type="radio"/> On <input checked="" type="radio"/> Off
	Name: <input type="text" value="PowerOutlet-7"/>	Wakeup Mode: <input type="radio"/> On <input checked="" type="radio"/> Off <input type="radio"/> Last State
	Description: <input type="text" value="Power Outlet 7"/>	Reboot: <input type="checkbox"/>
	Current: 0.0 Amps	
Outlet: P8	Status: Off	Power State: <input type="radio"/> On <input checked="" type="radio"/> Off
	Name: <input type="text" value="PowerOutlet-8"/>	Wakeup Mode: <input type="radio"/> On <input checked="" type="radio"/> Off <input type="radio"/> Last State
	Description: <input type="text" value="Power Outlet 8"/>	Reboot: <input type="checkbox"/>
	Current: 0.0 Amps	

- Enter the following:

Switching Delay	Number of milliseconds the SLB branch office manager between subsequent switching. The range is 1000-2500 msec. The default is 2000 msec (2 sec).
Over Current Alarm	If SNMP traps are enabled (see Chapter 7: Services on page 84), a trap (alarm) is sent if the total current for all outlets exceeds a threshold. Enter the number of amps (measured in tenths of an amp) above which the SLB unit sends a trap. The maximum is 180. <i>Note: If the alarm goes off, a warning message displays on the CLI.</i>
Current Level for all Outlets	Displays the total load carried by the outlets.

- View or enter the following information for each outlet:

Outlet	Displays the number of the outlet being configured.
Status	Displays the current state of the outlet.
Name	User-configurable name identifying the outlet.
Description (optional)	User-configurable text describing the outlet.
Current	Displays the load, in Amps, for the outlet.
Power State	Select whether the power should be on or off. Default is Off .
Wakeup Mode	Select whether, after a reboot, the power state for the outlet should be on, off, or returned to the state it was in before the reboot. Default is Off .
Last State	Select whether to return the outlet to the state it was in before the reboot.
Reboot	To power cycle the outlet, select the checkbox. Default is unchecked. <i>Note: You can reboot the SLB device on the Maintenance > Firmware & Configurations page, but after the reboot, the power outlet has the same power state as it did before the reboot.</i>

- To save, click **Apply**.

Power Commands

Go to [Power Commands \(on page 316\)](#) to view CLI commands which correspond to the web page entries described above.

Host Lists

A host list is a prioritized list of SSH, Telnet, and TCP hosts available for establishing incoming modem connections or for the connect direct command on the CLI. The SLB branch office manager cycles through the list until it successfully connects to one.

To view, update or delete a host list:

- Click the **Devices** tab and select the **Host Lists** option. The following page displays:

Figure 8-11 Devices > Host Lists

LANTRONIX[®] SLB882

Logout Host: slb8Ref_120-6100 User: sysadmin

Select port for Configuration WebSSH (DP only) Connected Device (DP only)

Network Services User Authentication **Devices** Maintenance Quick Setup

Device Status Device Ports Console Port USB Power Outlets Connections Host Lists Scripts Sites

Host Lists Help ?

Host Lists		
Id	Name	
1	HLServers1	<input checked="" type="radio"/>
2	HLServers2	<input type="radio"/>
3	HLServers3	<input type="radio"/>
4	judy2	<input type="radio"/>

View Host List Delete Host List

Host List Id: 1 Clear Host List

Host List Name: HLServers1 Add Host List

Retry Count: 1 Edit Host List

Authentication:

Host Parameters

Host:

Protocol: TCP

Port:

Escape Sequence:

Hosts (in order of precedence)





```
172.19.39.22:ssh/22,
172.19.37.2:ssh/22,
172.19.37.3:ssh/22,
0.0.0.123:tcp/6;123
```

2. Select a host list and click the View Host List button. The list of hosts display in the Hosts box along with the settings for the selected host list (Figure 8-11).
3. You have the following options with a selected, existing host list:
 - ◆ To delete the selected host list, click the **Delete Host List** button.
 - ◆ To edit the selected host list, follow the steps below beginning with step 5.
 - ◆ To add a new host list, follow the steps below beginning with proceed to step 4.
4. To add a new host list, first deselect any selected host list by clicking the **Clear Host List** button, then proceed to step 5.
5. Enter or modify host list settings:

Host List Settings

Host List Id	Displays after a host list is saved.
Host List Name	Enter a name for the host list.
Retry Count	Enter the number of times the SLB unit should attempt to retry connecting to the host list.

Authentication	Select to require authentication when the SLB device connects to a host.
Host	Name or IP address of the host.
Protocol	Protocol for connecting to the host (TCP, SSH, or Telnet).
Port	Port on the host to connect to.
Escape Sequence	The escape character used to get the attention of the SSH or Telnet client. It is optional, and if not specified, Telnet and SSH use their default escape character. For Telnet, the escape character is either a single character or a two-character sequence consisting of '^' followed by one character. If the second character is '?', the DEL character is selected. Otherwise, the second character is converted to a control character and used as the escape character. For SSH, the escape character is a single character.

6. Click the right  arrow. The host displays in the Hosts box.
7. Utilize the following options for managing the hosts in each host list:
 - ◆ To remove a host from the host list, select the host in the Hosts box and click the left  arrow.
 - ◆ To give the host a higher precedence, select the host in the Hosts box and click the up  arrow.
 - ◆ To give the host a lower precedence, select the host in the Hosts box and click the down  arrow.
8. Repeat steps above as necessary, to modify or add host lists.
9. Save your changes:
 - ◆ Click the **Add Host List** button if adding new host lists.
 - ◆ Click the **Clear Host List** button if editing existing host lists.

After the process completes, a link back to the [Device Ports > Settings](#) page displays.

Host List Commands

Go to [Host List Commands \(on page 302\)](#) to view CLI commands which correspond to the web page entries described above.

Scripts

The SLB branch office manager supports three types of scripts:

- ◆ **Interface Scripts** which use a subset of the Expect/Tcl scripting language to perform pattern detection and action generation on Device Port output.
- ◆ **Batch Scripts** which are a series of CLI commands.
- ◆ **Custom Scripts** are Expect scripts that use most of the Expect scripting language, can be run against the CLI or a Device Port, and can be scheduled to run at periodic intervals, with the results from each run saved to a file in a repository. Up to 10 Custom Scripts can be created. Each Custom Script run is an operation, and the results from each operation can be viewed. Up to 50 script result files will be saved locally in the SLB storage. Once this maximum is

reached and new result files are generated, the oldest result files will automatically be deleted to accommodate the new result files.

A user can create scripts at the web, view scripts at the web and the CLI, and use (run) scripts at the CLI. For a description of the syntax allowed in the various types of scripts, see [Batch Script Syntax](#), [Interface Script Syntax](#), and [Custom Script Syntax](#). Example Custom Scripts for Expect, Tcl and Python are provided.

The following versions are supported: Expect 5.45.4, Tcl 8.6.8, and Python 3.6.7. For Python scripts, the [Pexpect](#) module is supported.

All scripts have permissions associated with them; a user who runs a script must have the permissions associated with the script in order to run the script.

To add a script:

1. Click the **Devices** tab and select the **Scripts** option. This page displays.

Figure 8-12 Devices > Scripts

The screenshot shows the LANTRONIX SLB882/8824 web interface. At the top, there is a navigation bar with tabs for Network, Services, User Authentication, Devices (selected), Maintenance, and Quick Setup. Below this is a sub-menu with links for Device Status, Device Ports, Console Port, USB, Power Outlets, Connections, Host Lists, Scripts (selected), and Sites. The main content area is titled 'Scripts' and includes a 'Help?' button. There are buttons for 'Add Script' and 'Rename Script' with a 'New Name:' input field. The current date/time is 04/04/19 01:03. There are links for 'Refresh', 'Latest Script Results', and 'Script Operations'. A table titled '2 Script(s)' is displayed with columns for Name, Type, Grp, State, Start Time, Freq (H), Stop Time, Device, and Status. The table contains two rows: 'temperature' and 'getdevicetemp', both with a status of 'Yet to be Scheduled'.

Name	Type	Grp	State	Start Time	Freq (H)	Stop Time	Device	Status
temperature	Custom	Adm	N/A	N/A	N/A	N/A	N/A	Yet to be Scheduled
getdevicetemp	Custom	Adm	N/A	N/A	N/A	N/A	N/A	Yet to be Scheduled

- Click the **Add Script** button. The page for editing script attributes displays.

Figure 8-13 Adding or Editing New Scripts

The screenshot shows the Lantronix SLB882/8824 web interface. At the top, there is a navigation menu with tabs for Network, Services, User Authentication, Devices, Maintenance, and Quick Setup. Below the menu, there are links for Device Status, Device Ports, Console Port, USB, Power Outlets, Connections, Host Lists, Scripts, and Sites. The main content area is titled 'Scripts' and contains a 'Script Name' input field, a 'Type' selection (Interface, Batch, Custom), and a large text area for script content. Below the text area, there is a 'User Rights' section with various checkboxes for permissions, including Full Administrative, Networking, Services, Secure Lantronix Network, Date/Time, Local Users, Remote Authentication, SSH Keys, User Menus, Web Access, Diagnostics & Reports, Reboot & Shutdown, Firmware & Configuration, Device Port Operations, Device Port Configuration, USB, and Power Outlets. There is also a 'Back to Scripts' link and an 'Apply' button.

- Enter the following:

Scripts

Script Name	A unique identifier for the script.
Type	<ul style="list-style-type: none"> ◆ Select Interface for a script that utilizes Expect/Tcl to perform pattern detection and action generation on Device Port output. ◆ Select Batch for a script of CLI commands. ◆ Select Custom for an Expect, Tcl, or Python script that can be run against a CLI session or a Device Port, either manually or scheduled to run at periodic intervals.

Script Text	<ul style="list-style-type: none"> ◆ In the free-form editing box, enter the contents of the script. Restrictions on the script format are described in Batch Script Syntax, Interface Script Syntax, and Custom Script Syntax.
--------------------	--

4. In the **User Rights** section, select the user **Group** to which the script will belong:

User Rights

Group	<p>Select the group to which the script will belong:</p> <ul style="list-style-type: none"> ◆ Default Users: This group has only the most basic rights. You can specify additional rights for the individual user . ◆ Power Users: This group has the same rights as Default Users plus Networking, Date/Time, Reboot & Shutdown, and Diagnostics & Reports. You can specify additional rights for the individual user. ◆ Administrators: This group has all possible rights. <p>For more information on how the group and rights are used with scripts, see To use a script at the CLI: below.</p>
--------------	--

5. Assign or unassign **User Rights** for the specific user by checking or unchecking the following boxes:

Full Administrative	Right to add, update, and delete all editable fields.
Networking	Right to enter Network settings.
Services	Right to enable and disable system logging, SSH and Telnet logins, SNMP, and SMTP.
Secure Lantronix Network	Right to view and manage secure Lantronix units (e.g., SLP, Spider, SLC and SLB units) on the local subnet.
Date/Time	Right to set the date and time.
Local Users	Right to add or delete local users on the system.
Remote Authentication	Right to assign a remote user to a user group and assign a set of rights to the user.
SSH Keys	Right to set SSH keys for authenticating users.
User Menus	Right to create a custom user menu for the CLI for NIS users.
Web Access	Right to access Web-Manager.
Diagnostics & Reports	Right to obtain diagnostic information and reports about the unit.
Reboot & Shutdown	Right to use the CLI or shut down the SLB unit and then reboot it.
Firmware & Configuration	Right to upgrade the firmware on the unit and save or restore a configuration (all settings). Selecting this option automatically selects Reboot & Shutdown.
Device Port Operations	Right to enter device port settings for operations.
Device Port Configurations	Right to enter device port configurations.
USB	Right to enter modem settings for USB.
Power Outlets	Right to configure power outlets.

6. To save, click the **Apply** button. If the type of script is Interface, the script will be validated before it is saved. Once the script is saved, the main *Scripts* page is displayed.

To view or update a script:

1. In the Scripts table, select the script and click the **Edit Script** button. The page for editing script attributes displays (see [Figure 8-13](#)).
2. Update the script **attributes** (see [To add a script:](#) above).
3. To save, click the **Apply** button.

To rename a script:

1. In the Scripts table, select the script and enter a new script name in the **New Name** field.
2. Click the **Rename Script** button. The script will be renamed and the *Devices > Scripts* page redisplay.

To delete a script:

1. In the Scripts table, select the script to delete.
2. Click the **Delete Script** button. After a confirmation, the script will be deleted and the *Devices > Scripts* page redisplay.

To schedule a custom script:

1. Click the **Devices** tab and select the **Scripts** option. The Scripts page displays.
2. In the Scripts table, select the script and click the **Schedule** button. The Custom Scripts - Schedule page displays.

Figure 8-14 Devices > Scripts - Scheduler

LANTRONIX[®] SLB882/8824

Logout Host: slb2056 User: sysadmin

Select port for Configuration WebSSH (DP only) Connected Device (DP only)

Network Services User Authentication **Devices** Maintenance Quick Setup

Device Status Device Ports Console Port USB Power Outlets Connections Host Lists Scripts Sites

Custom Scripts - Schedule Help?

Script Name:

Device Type: CLI Device Port:

State: Enable Disable Delete

Command Line Arguments:

Start Time: Now At Date/Time: April 4 2019 01:03:00 am

Frequency: Hours Days

Stop Time: Forever At Date/Time: April 4 2019 01:03:00 am

[Back to Scripts](#)

3. Enter the following (each Custom Script can be run against one device - CLI or Device Port -

with one schedule):

Device Type	The device - either the CLI or a Device Port - that the script is connected to.
State	The state of the script's schedule. A script must be Enabled in order for the script scheduler to begin running the schedule. Once a script has been scheduled and enabled, it can be Disabled; in this state the script manager will continue to update the scheduled run time for a script, but the script will not be run or produce any results. At any point a schedule for a script can be Deleted.
Command Line Arguments	Optional command line arguments to pass to the script each time it is run.
Start Time	The date and time when the script should start running, either Now or at a specific date and time.
Frequency	How often the script will run, given in hours or days. The web UI and CLI will always display the frequency in hours.
Stop Time	The date and time when the script should stop running, either at a specified date and time, or Forever if it should never stop running.

4. To save, click the **Apply** button. The schedule will be validated, and the script manager will either immediately start running the script or schedule the next run of the script. The main **Scripts** page is displayed, showing the schedule status of the script (this may take a few seconds to be updated while the script manager processes the script - click **Refresh** to view the latest information).

Notes on scheduling:

- ◆ Scripts that are scheduled to start immediately and run forever will be restarted when the SLB is rebooted.
- ◆ Scripts that are scheduled to start at a specific time will be restarted when the SLB is rebooted if the script is scheduled to run forever or if the stop time has not expired.
- ◆ After the SLB has booted, there will be a short delay after launching each script before starting the next script in order to minimize the impact on system resources. Shortly after boot, if the script status shows that a script is not scheduled when the script is configured with a schedule, refreshing the status will eventually show that all scheduled scripts will be running and/or scheduled.
- ◆ If the date, time or timezone is changed on the SLC or SLB while a script is scheduled, the CLI and web UI will still show the same scheduled date and time for the script, until the next time the script is run. It is recommended that the date, time and timezone not be changed while scripts are scheduled to run.

To change the Enable/Disable state of a custom script schedule:

1. In the Scripts table, select the script to enable or disable.
2. Click the **Enable** button (this will resume running of a script at its next scheduled time if it was previously disabled) or the **Disable** button (this will suspend running of a script but continue to update the schedule). The script's state will be updated and the Scripts page redisplay.

To view the list of completed operations (runs) for a custom script:

1. In the Scripts table, select the script to view operations for, and click **Script Operations**.

- The Custom Scripts - Operations page displays, with a list of any results that have been generated for a script, in reverse date/time order.

Figure 8-15 Custom Scripts - Operations

The screenshot shows the LANTRONIX SLB882/8824 web interface. At the top, there is a navigation bar with tabs for Network, Services, User Authentication, Devices, Maintenance, and Quick Setup. Below this is a sub-navigation bar with links for Device Status, Device Ports, Console Port, USB, Power Outlets, Connections, Host Lists, Scripts, and Sites. The main content area is titled 'Custom Scripts - Operations' and includes a 'Back to Scripts' link. The page displays a table of operations for a script named 'Script temperature'. The table has two columns: 'Set Number' and 'Set Name'. There are 5 rows of data, each with a radio button in the rightmost column. The first row is selected.

Set Number	Set Name	
9187797312368287677	temperature_190208_025003.txt	<input checked="" type="radio"/>
9187797312368287676	temperature_190208_024837.txt	<input type="radio"/>
9187797312368287675	temperature_190208_024524.txt	<input type="radio"/>
9187797312368287674	temperature_190208_024315.txt	<input type="radio"/>
9187797312368287673	temperature_190208_024135.txt	<input type="radio"/>

- Any of the results can be viewed by selecting the operation and clicking **Script Results**.

To view the latest results from a completed operation (run) of a custom script:

1. Click the **Devices** tab and select the **Scripts** option. The Scripts page displays.
2. In the Scripts table, select the script to view results for, and click **Latest Results**.

The results are displayed in a popup window.

Figure 8-16 View Custom Script Results

SLB882 - Script Results

```
Script temperature, operation temperature_190208_025003.txt:
expect version 5.43.0
argv[0] = /bin/expect argv[1] = -d argv[2] = /www/xml/scripts/custom/temperature argv[3] = SLB_2056
set argc 1
set argv0 "/www/xml/scripts/custom/temperature"
set argv "SLB_2056"
executing commands from command file /www/xml/scripts/custom/temperature
Internal temperature of the SLB_2056 SLC at 02/08/19 02:50
parent: waiting for sync byte
parent: telling child to go ahead
parent: now unsynchronized from child
spawn: returns {23943}

expect: does "" (spawn_id exp4) match glob pattern "Need to specify username"? no
"*> "? no

expect: does "\r\n" (spawn_id exp4) match glob pattern "Need to specify username"? no
"*> "? no

expect: does "\r\n\r\n\r\nWelcome to the Secure Lantronix Console Manager\r\n\r\nModel Number: SLB882\r\n\r\nFor a list of comm.
"*> "? yes
expect: set expect_out(0,string) "\r\n\r\n\r\nWelcome to the Secure Lantronix Console Manager\r\n\r\nModel Number: SLB882\r\n\r\n"
expect: set expect_out(spawn_id) "exp4"
expect: set expect_out(buffer) "\r\n\r\n\r\nWelcome to the Secure Lantronix Console Manager\r\n\r\nModel Number: SLB882\r\n\r\n"
send: sending "\n" to { exp4 }

expect: does "" (spawn_id exp4) match regular expression "\n\r(\[[^\r]*])"? no

expect: does "\r\n\r\n\r\n[slb2056]>" (spawn_id exp4) match regular expression "\n\r(\[[^\r]*])"? yes
expect: set expect_out(0,string) "\n\r[slb2056]>"
expect: set expect_out(1,string) "[slb2056]>"
expect: set expect_out(spawn_id) "exp4"
expect: set expect_out(buffer) "\r\n\r\n\r\n[slb2056]>"
send: sending "show temperature\n" to { exp4 }

expect: does " " (spawn_id exp4) match regular expression "Current Internal Temperature: (.*)\r\n"? no

expect: does " show temperature\r\nshow temperature\r\n\r\n" (spawn_id exp4) match regular expression "Current Internal Tem

expect: does " show temperature\r\nshow temperature\r\n\r\n__Internal Temperature_____

expect: does " show temperature\r\nshow temperature\r\n\r\n__Internal Temperature_____
expect: set expect_out(0,string) "Current Internal Temperature: 38C (100F)\r\n"
expect: set expect_out(1,string) "38C (100F)"
expect: set expect_out(spawn_id) "exp4"
expect: set expect_out(buffer) " show temperature\r\nshow temperature\r\n\r\n__Internal Temperature_____
Temperature: 38C (100F)
send: sending "logout\n" to { exp4 }
```

To use a script at the CLI:

1. To run an Interface Script or a Custom Script on a device port for pattern recognition and action generation, use the `connect script <Script Name> deviceport <Device Port # or Name>` command. This action requires that a SLB user running the connect script command have Device Port Operations (do) rights and port permissions for the selected device port.
2. To run a Batch Script at the CLI with a series of CLI commands, or a Custom Script for pattern recognition and action generation, use the `set script runcli <Script Name>`

command. This action requires that a SLB user running the **runcli** command belong to a group that is the same or greater than the group assigned to the script (e.g., if the script is assigned to the Power group, the user running the **runcli** command must belong to the Power or Admin group). For Batch Scripts, if this minimum group requirement is met, the SLB user will temporarily be granted all of the individual rights assigned to the script while the Batch Script is running. It is recommended that scripts that spawn disession only be used with the `set script runcli` command (and not the `connect script` command), and that scripts that spawn portsession only be used with the `connect script` command (and not the `set script runcli` command).

Note: Custom Scripts have a `debug enable` option that supports printing Expect debug information to aid in creating an Expect script. The debug option is not supported for Tcl and Python scripts.

Batch Script Syntax

The syntax for Batch Scripts is exactly the same as the commands that can be typed at the CLI, with the additions described in this section.

The `sleep` command suspends execution of the script (puts it to 'sleep') for the specified number of seconds. Syntax:

```
sleep <value>
```

The `while` command allows a loop containing CLI commands to be executed. Syntax:

```
while {<Boolean expression>} {
    CLI command 1
    CLI command 2
    ...
    CLI command n
}
```

Note: The closing left brace `}` must be on a line without any other characters. To support a `while` command, the `set` command, variables, and secondary commands are also supported.

Interface Script Syntax

This section describes the abbreviated scripting syntax for Interface Scripts. This limited syntax was created to prevent the creation of scripts containing potentially harmful commands. Script commands are divided into three groups: Primary, Secondary and Control Flow. Primary commands provide the basic functionality of a script and are generally the first element on a line of a script, as in:

```
send_user "Password:"
```

Secondary commands provide support for the primary commands and are generally not useful by themselves. For example, the `expr` command can be used to generate a value for a `set` command.

```
set <my_var> [expr 1 + 1]
```

Control Flow commands allow conditional execution of other commands based on the results of the evaluation of a Boolean expression.

Table 8-17 Definitions

Term	Definition
Word	A contiguous group of characters delimited on either side by spaces. Not enclosed by double quotes.
Primary Command	One of the primary commands listed in this section.
Secondary Command	One of the secondary commands defined in this section.
Quoted String	A group of characters enclosed by double quote (") characters. A quoted string may include any characters, including space characters. If a double quote character is to be included in a quoted string it must be preceded (escaped) by a backslash character (\).
Variable Reference	A word (as defined above) preceded by a dollar sign character (\$).
CLI Command	A quoted string containing a valid CLI <code>show</code> command.
Arithmetic Operator	A single character representing a simple arithmetic operation. The character may be one of the following: <ul style="list-style-type: none"> ◆ A plus sign (+) representing addition ◆ A minus sign (-) representing subtraction ◆ An asterisk sign (*) representing multiplication ◆ A forward slash (/) representing division ◆ A percent sign (%) representing a modulus
Boolean Expression	An expression which evaluates to TRUE or FALSE. A Boolean expression has the following syntax: <pre><value> <Boolean operator> <value></pre> Each can be either a word or a variable reference.
Boolean Operator	A binary operator which expresses a comparison between two operands and evaluates to TRUE or FALSE. The following Boolean operators are valid: <ul style="list-style-type: none"> ◆ '<' less than ◆ '>' greater than ◆ '<=' less than or equal to ◆ '>=' greater than or equal to ◆ '==' equal to ◆ '!=' not equal to

Primary Commands

These are `stand-alone` commands which provide the primary functionality in a script. These commands may rely on one or more of the Secondary Commands to provide values for some parameters. The preprocessor will require that these commands appear only as the first element of a command line. The start of a command line is delimited by any of the following:

- ◆ The start of a new line of text in the script
- ◆ A semicolon (;)
- ◆ A left brace ({)

Table 8-18 Primary Commands

Command	Description
set	<p>The <code>set</code> command assigns a value to a variable. Syntax:</p> <pre>set <variable> <value></pre> <p>where <variable> is a word, and <value> can be defined in one of the following ways:</p> <ul style="list-style-type: none"> ◆ A quoted string ◆ A word ◆ A variable reference ◆ A value generated via one of the string secondary commands (<code>compare</code>, <code>match</code>, <code>first</code>, etc.) ◆ A value generated via the <code>expr</code> secondary command ◆ A value generated via the <code>format</code> secondary command ◆ A value generated via the <code>expr timestamp</code> command
unset	<p>This command removes the definition of a variable within a script. Syntax:</p> <pre>unset <variable></pre> <p>where <variable> is a word.</p>
scan	<p>The <code>scan</code> command is analogous to the C language <code>scanf()</code>. Syntax:</p> <pre>scan <variable> <format string> <value 1> <value 2> ... <value n></pre> <p>where <variable> a variable reference, and <format string> is a quoted string. Each of the <value x> elements will be a word.</p>
sleep	<p>The <code>sleep</code> command suspends execution of the script (puts it to 'sleep') for the specified number of seconds. Syntax:</p> <pre>sleep <value></pre> <p>where <value> can be a word, a quoted string or a variable reference.</p>
exec	<p>The <code>exec</code> command executes a single CLI command. Currently only CLI 'show' commands may be executed via <code>exec</code>. Syntax:</p> <pre>exec <CLI command></pre>
send, send_user	<p>The <code>send</code> command sends output to a sub-process, The <code>send_user</code> command sends output to the standard output. Both commands have the same syntax:</p> <pre>send <string></pre> <pre>send_user <string></pre> <p>where <string> can be either a quoted string or a variable reference.</p>
expect, expect_user, expect_before, expect_after, expect_background	<p>The <code>expect</code> command waits for input and attempts to match it against one or more patterns. If one of the patterns matches the input the corresponding (optional) command is executed. All <code>expect</code> commands have the same syntax:</p> <pre>expect {<string 1> {command 1} <string 2> {command 2} ... <string n> {command n}}</pre> <p>where <string x> will either be a quoted string, a variable reference or the reserved word 'timeout.' The command x is optional, but the curly braces ('{' and '}') are required. If present it must be a primary command.</p>
return	<p>The <code>return</code> command terminates execution of the script and returns an optional value to the calling environment. Syntax:</p> <pre>return <value></pre> <p>where <value> can be a word or a variable reference.</p>

Secondary Commands

These are commands which provide data or other support to the Primary commands. These commands are never used by themselves in a script. The preprocessor will require that these commands always follow a left square bracket ('[') character and be followed on a single line by a right bracket (']').

Table 8-19 Secondary Commands

Command	Description
string	<p>The string command provides a series of string manipulation operations. The string command will only be used with the set command to generate a value for a variable. There are nine operations provided by the string command. Syntax (varies by operation):</p> <pre>string compare <str 1> <str 2></pre> <p>Compare two strings</p> <pre>string match <str 1> <str 2></pre> <p>Determine if two strings are equal</p> <pre>string first <str needle> <str haystack></pre> <p>Find and return the index of the first occurrence of 'str_needle' in 'str_haystack'</p> <pre>string last <str needle> <str haystack></pre> <p>Find and return the index of the last occurrence of 'str_needle' in 'str_haystack'</p> <pre>string length <str></pre> <p>Return the length of 'str'</p> <pre>string index <str> <int></pre> <p>Return the character located at position 'int' in 'str'</p> <pre>string range <str> <int start> <int end></pre> <p>Return a string consisting of the characters in 'str' between 'int start' and 'int end'</p> <pre>string tolower <str></pre> <p>Convert <str> to lowercase</p> <pre>string toupper <str></pre> <p>Convert <str> to uppercase</p> <pre>string trim <str 1> <str 2></pre> <p>Trim 'str 2' from 'str 1'</p> <pre>string trimleft <str 1> <str 2></pre> <p>Trim 'str 2' from the beginning of 'str 1'</p> <pre>string trimright <str 1> <str 2></pre> <p>Trim 'str 2' from the end of 'str 1'</p> <p>In each of the above operations, each <str *> element can either be a quoted string or a variable reference. The <int *> elements will be either words or variable references.</p>

Command	Description
<code>expr</code>	This command evaluates an arithmetic expression and returns the result. The <code>expr</code> command will only be used in combination with the <code>set</code> command to generate a value for a variable. Syntax: <code>expr <value> <operation> <value></code> Each <value> will be either a word or a variable reference, and <operation> an arithmetic operation.
<code>timestamp</code>	This command returns the current time of day as determined by the SLB device. The <code>timestamp</code> command will only be used in combination with the <code>set</code> command to produce the value for a variable. Syntax: <code>timestamp <format></code> where <format> is a quoted string.
<code>format</code>	The <code>format</code> command is analogous to the C language <code>sprintf()</code> . The <code>format</code> command will only be used in combination with the <code>set</code> command to produce the value for a variable. Syntax: <code>format <format string> <value 1> <value 2> ... <value n></code> where <format string> will be a quoted string. Each of the <value x> elements will be a word, a quoted string or a variable reference.

Control Flow Commands

The `control flow` commands allow conditional execution of blocks of other commands. The preprocessor treats these as Primary commands, allowing them to appear anywhere in a script that a Primary command is appropriate.

Table 8-20 Control Flow Commands

Command	Description
<code>while</code>	The <code>while</code> command executes an associated block of commands as long as its Boolean expression evaluates to TRUE. After each iteration the Boolean expression is re-evaluated; when the Boolean expression evaluates to FALSE execution passes to the first command following the associated block. Each command within the block must be a Primary command. Syntax: <code>while {<Boolean expression>} {</code> <code> command 1</code> <code> command 2</code> <code> ...</code> <code> command n</code> <code>}</code>

Command	Description
if, elseif and else	<p>The <code>if</code> command executes an associated block of commands if its Boolean expression evaluates to TRUE. Each command within the block must be a Primary command. Syntax:</p> <pre>if {<Boolean expression>} { command 1 command 2 ... command n }</pre> <p>The <code>elseif</code> command is used in association with an <code>if</code> command - it must immediately follow an <code>if</code> or <code>elseif</code> command. It executes an associated block of commands if its Boolean expression evaluates to TRUE. Each command within the block must be a Primay command. Syntax:</p> <pre>elseif {<Boolean expression>} { command 1 command 2 ... command n }</pre> <p>The <code>else</code> command is used in combination with an <code>if</code> or <code>elseif</code> command to provide a default path of execution. If the Boolean expressions for all preceding <code>if</code> and <code>elseif</code> commands evaluate to FALSE the associated block of commands is executed. Each command within the block must be a primary command. Syntax:</p> <pre>else { command 1 command 2 ... command n }</pre>

Custom Script Syntax

This section describes the scripting syntax for Custom Scripts. The syntax is more flexible than Interactive Script syntax, but still has restrictions to prevent the creation of scripts containing potentially harmful commands. In addition, Custom Scripts can be configured to use command line parameters. Custom Scripts have the following guidelines:

1. The size of the script file cannot exceed 6 Kbytes.
2. The size of the results generated by the script cannot exceed 1 Kbyte (any results over 1Kbyte will be truncated).
3. The first line of the script must contain a Linux script style interpreter directive so that the SLB will know which interpreter to use to run the script. The format of the first line is `#! expect`, `#! tcl`, or `#! python`. When a custom script is imported, the interpreter line must match the selected script or file type (Expect, Tcl or Python), otherwise the script will be invalid.
4. The script should include a spawn command to connect the script to either a SLB CLI session or a SLB Device Port session. Refer to the following spawn command syntax:

Note:

- ◆ For CLI sessions, a local user name should be given
- ◆ For Device Port sessions, the `$devicePort` variable will be used by the SLB to connect the script to the appropriate Device Port. The `-noecho` flag may be passed to `spawn` command.
- ◆ Expect script - CLI session

```
spawn clisession -U <username>
```
- ◆ Expect script - Device Port session

```
spawn portsession -p $devicePort
```
- ◆ Tcl script - CLI session

```
set io [open "| clisession -U <username>" r+]
```
- ◆ Tcl script - Device Port session

```
set io [open "| portsession -p $devicePort" r+]
```
- ◆ Python script - CLI session

```
subprocess.Popen(['clisession', '-U', '<username>'],
                 stdin=subprocess.PIPE,
                 stdout=subprocess.PIPE,
                 stderr=subprocess.PIPE)
```
- ◆ Python script - Device Port session

```
subprocess.Popen(['portsession', '-p', devicePort],
                 stdin=subprocess.PIPE,
                 stdout=subprocess.PIPE,
                 stderr=subprocess.PIPE)
```

It is recommended that scripts that spawn `clisession` only be used with the `set script runcli` command (and not the `connect script` command), and that scripts that spawn `portsession` only be used with the `connect script` command (and not the `set script runcli` command).

5. The script cannot contain commands which spawn or fork other commands, read or write files on the SLB filesystem, or interrogate the SLB environment. The list of commands that are not allowed for Expect scripts includes `"fork"`, `"open"`, `"exp_open"`, `"exec"`, `"system"`, `"log_file"`, `"pwd"`.
6. For scripts that return an exit code, the SLB will interpret an exit code of zero as a successful exit code, and any non-zero exit code as an error. Non-zero exit codes are displayed (at the CLI) or logged (for scripts that are run by the script scheduler).

Example Scripts

Interface Script—Monitor Port

The Monitor Port (Monport) script connects directly to a device port by logging into the SLB port, gets the device hostname, loops a couple of times to get port interface statistics, and logs out. The following is the script:

```

set monPort 7
set monTime 5
set sleepTime 2
set prompt ">"
set login "sysadmin"
set pwd "PASS"
#Send CR to echo prompt
send "\r"
sleep $sleepTime
#Log in or check for Command Prompt
expect {
    #Did not capture "ogin" or Command Prompt
    timeout { send_user "Time out login.....\r\n"; return }
    #Got login prompt
    "login" {
        send_user "Logging in....\r\n"
        send "$login\r"
        expect {
            timeout { send_user "Time out waiting for pwd
                prompt.....\r\n"; return }
            #Got password prompt
            "password" {
#Send Password
send "$pwd\r"
        expect {
            timeout { send_user "Time out waiting for prompt.....\r\n";
                return }
            $prompt {}
        }
    }
}
}
#Already Logged in got Command Prompt
$prompt {
send_user "Already Logged....\r\n"
}
}
#Get hostname info
send "show network port 1 host\r"
expect {
    timeout { send_user "Time out Getting Hostname 1\r\n"; return }
    "Domain" {
        #Get Hostname from SLB
        set hostname "[string range $expect_out(buffer) [string first
            Hostname:

```

```

        $expect_out(buffer)] [expr [string first Domain
        $expect_out(buffer)]-2]] "
    }
}
send_user "\r\n\r\n\r\n\r\n\r\n\r\n"
send_user "Device [string toupper $hostname]\r\n"
send_user "_____ \r\n"
send_user "Monitored Port: Port $monPort \r\n"
send_user "Monitor Interval Time: $monTime Seconds \r\n"
set loopCtr 0
set loopMax 2
while { $loopCtr < $loopMax } {
    #Get current time

```

The following is the screen output:

```

slb247glenn]> conn script ex4 deviceport 7
login: Logging in....
sysadmin
sysadmin
Password: PASS
Welcome to the Secure Lantronix Branch Office Manager
Model Number: SLB 48
For a list of commands, type 'help'.
[slb251glenn]> show network port 1 host
show network port 1 host
___Current Hostname Settings___
Hostname: slb251glenn
Domain: support.int.lantronix.com
[slb251glen
Device HOSTNAME: SLB 251GLENN

Monitored Port: Port 7
Monitor Interval Time: 5 Seconds
[Current Time:21:16:43]
show portcounter deviceport 7
n]> show portcounter deviceport 7
Device Port: 7 Seconds since zeroed: 1453619
Bytes input: 0 Bytes output: 0
Framing errors: 0 Flow control errors: 0
Overrun errors: 0 Parity errors: 0
[slb251glenn]>
[Current Time:21:16:58]
show portcounter deviceport 7
show portcounter deviceport 7
Device Port: 7 Seconds since zeroed: 1453634
Bytes input: 0 Bytes output: 0
Framing errors: 0 Flow control errors: 0
Overrun errors: 0 Parity errors: 0
[slb251glenn]>
Port Counter Monitor Script Ending.....

Login Out.....
logout
Returning to command line

```

```
[slb247glenn] >
```

Batch Script—SLB CLI

This script runs the following SLB CLI commands, then runs the Monport Interface script:

- ◆ show network port 1 host
- ◆ show deviceport names
- ◆ show script
- ◆ connect script monport deviceport 7

The following is the screen output of the script:

```
[slb247glenn] > se script runcli cli
[slb247glenn] > show network port 1 host
___ Current Hostname Settings ___
Hostname: slb247glenn
Domain: <none>
[slb247glenn] >
[slb247glenn] > show deviceport names
___ Current Device Port Names ___
01 - SCS_ALIAS_Test 05 - Port-5
02 - Port-2 06 - Port-6
03 - Port-3 07 - SLB -251
04 - Port-4 08 - Port-8
[slb247glenn] >
[slb247glenn] > show script
___ Interface Scripts ___ Group/Permissions ___
getslb Adm/ad,nt,sv,dt,lu,ra,um,dp,pc,rs,fc,dr,sn,wb,sk,po,do
Test Adm/ad,nt,sv,dt,lu,ra,um,dp,pc,rs,fc,dr,sn,wb,sk,po,do
monport Adm/<none>
___ Batch Scripts ___ Group/Permissions ___
cli Adm/ad,nt,sv,dt,lu,ra,um,dp,pc,rs,fc,dr,sn,wb,sk,po,do
[slb247glenn] >
[slb247glenn] > connect script monport deviceport 7
login: Logging in....
sysadmin
sysadmin
Password: PASS
Welcome to the Secure Lantronix Branch Office Manager
Model Number: slb 48
For a list of commands, type 'help'.
[slb251glenn] > show network port 1 host
show network port 1 host
___ Current Hostname Settings ___
Hostname: slb251glenn
Domain: support.int.
Device HOSTNAME: SLB 251GLENN
___
Monitored Port: Port 7
Monitor Interval Time: 5 Seconds
[Current Time:21:25:04]
show portcounter deviceport 7
lantronix.com
```

```
[slb251glenn]> show portcounter deviceport 7
Device Port: 7 Seconds since zeroed: 1454120
Bytes input: 0 Bytes output: 0
Framing errors: 0 Flow control errors: 0
Overrun errors: 0 Parity errors: 0
[slb251glenn]>
[Current Time:21:25:20]
show portcounter deviceport 7
show portcounter deviceport 7
Device Port: 7 Seconds since zeroed: 1454136
Bytes input: 0 Bytes output: 0
Framing errors: 0 Flow control errors: 0
Overrun errors: 0 Parity errors: 0
[slb251glenn]>
Port Counter Monitor Script Ending.....
```

```
Login Out.....
```

```
logout
```

```
Returning to command line
```

```
[slbvz249_glenn]> show script
```

Interface Scripts	Group/Permissions
test3	Def/do
Batch Scripts	Group/Permissions
test1	Adm/

```
ad, nt, sv, dt, lu, ra, um, dp, ub, rs, fc, dr, sn, wb, sk, po, do
[slbvz249_glenn]>
```

Expect Custom Script - SLB CLI Session

An example of an Expect Custom Script that interacts with a SLB CLI session:

```
#! expect
# script to get the current internal temperature of the SLB
# accepts one optional command line parameter for location

set slbPrompt ">"
set slbTemp    "unknown"
set location   ""

proc myprint {str} {
    send_user -- "$str\n"
}

proc abortSession {err} {
    send_user "Error $err. Terminating session.\n"
    exit $err
}

# Are there any command line parameters?
if {$argc > 0} {
    set location [lindex $argv 0]
}

set now [clock seconds]
```



```
exit 0
```

This script can be run manually at the CLI:

```
[slb431d] set script runcli cliExample parameters "East Data Center"
Internal temperature of the East Data Center SLB at 01/27/2019 02:07
Temperature: 48C (118F)
```

Expect Custom Script - SLB Device Port Session

An example of an Expect Custom Script that interacts with a SLB Device Port (in this example a ServerTech PDU is connected to a Device Port):

```
#!/ expect
#
# Script to get the load of a ServerTech PDU outlet
#

set pduPrompt ">"
set pduLoad    "unknown"

proc myprint {str} {
    send_user -- "$str\n"
}

proc abortSession {err} {
    send_user "Error $err. Terminating session.\n"
    exit $err
}

set now [clock seconds]
set date [clock format $now -format {%D %R}]
myprint "Load of ServerTech PDU outlet B1 at $date"

# spawn the port session on a device port
if {[catch {spawn -noecho portsession -p $devicePort} result]} {
    abortSession 1
}
set sessionId $spawn_id

# Handle eof
expect_after {
    -i $sessionId eof {
        myprint "Session unexpectedly terminated."
        abortSession 2
    }
}

set timeout 10
log_user 0

#
# Login to the PDU
# The "Error:*" pattern matches all error messages output by portsession
```

```

#
send "\n"
expect {
    "Username:" { send "admn\n" }
    "Error:*\r\n" { send_user $expect_out(0,string); abortSession 2 }
}
expect "Password:"
send "admn\n"

# Wait for the first prompt
set loggedIn false
while {! $loggedIn} {
    expect {
        timeout {myprint "Timeout waiting to login"; abortSession 3}
        "*CDU: " {set loggedIn true}
    } ;
}

# Detect the prompt
exp_send "\n"
expect "are:\r\n"
expect "LOGIN\r\n"
expect "REMOVE\r\n"
expect "RESTART\r\n"
expect {
    timeout {myprint "Timeout waiting for prompt"; abortSession 3}
    -re "\r\n([\r]*:)"
}
set pduPrompt $expect_out(1,string)

# Run the ostat command
exp_send "ostat .b1\n"
expect "Outlet*Power\r\n"
expect "ID*Watts*\r\n"
expect {
    timeout {myprint "Timeout waiting for load"; abortSession 3}
    -re "\.B1\\s+\\S+\\s+\\S+\\s+\\S+(\\S+)"
}
set pduLoad $expect_out(1,string)
myprint "Outlet B1 Load: $pduLoad Amps"

expect $pduPrompt
exp_send "logout\n"

sleep .5
close
exit 0

```

Expect Custom Script - SLB Device Port Session

An example of an Expect Custom Script that interacts with a SLC or SLB Device Port (in this example a Cisco server is connected to a Device Port):

```

#! expect
#
# Save a copy of the running config of a Cisco server to a TFTP server
# The Cisco server is connected to a SLC/B device port
#

proc myprint {str} {
    send_user -- "$str\n"
}

proc abortSession {err} {
    send_user "Error $err. Terminating session.\n"
    exit $err
}

if {$argc < 2} {
    myprint "Usage: script_md_cisco.exp <TFTP Server> <Backup File Name>"
    abortSession 1
}

set tftp [lindex $argv 0]
set configFile [lindex $argv 1]
set enablePassword "secret"
set timeout 10

set now [clock seconds]
set date [clock format $now -format {%D %R}]
myprint "Backing up Cisco Server to $tftp:$configFile at $date"

# spawn the port session on a device port
if {[catch {spawn -noecho portsession -p $devicePort} result]} {
    abortSession 2
}
set sessionId $spawn_id

# Handle eof
expect_after {
    -i $sessionId eof {
        myprint "Session unexpectedly terminated."
        abortSession 3
    }
}

log_user 0

# Send carriage return, see if we are connected
set loggedIn false
set execMode false

```

```
set passwordPrompt false
set cnt 1
while {! $loggedIn || ! $execMode} {
  if {$cnt == 5} {
    myprint "Timeout waiting for > or # prompt"
    abortSession 4
  }
  if {! $passwordPrompt} {
    send "\r"
  }
  expect {
    "*assword: " { send "$enablePassword\r" }
    ">" { set loggedIn true; set passwordPrompt true; send "enable\r" }
  }
  "#" { set loggedIn true; set execMode true }
  "Error:*\\r\\n" { send_user $expect_out(0,string); abortSession 5 }
  timeout {set cnt [expr {$cnt + 1}] }
}

myprint "Logged in."

send "copy running-config tftp://$tftp/$configFile\r"
expect "$tftp"
send "\r"
expect "$configFile"
send "\r"
myprint "Backup initiated."
expect {
  "!!" { myprint "Successfully backed up." }
  timeout { myprint "Timeout waiting for backup to complete.";
abortSession 6 }
}
send "exit\r"

sleep .5
close
exit 0
```

Python Custom Script - SLB CLI Session

An example of a Python Custom Script that interacts with a CLI session:

```

#! python
# Script to set the RADIUS authentication settings of the SLB
# Sets the first RADIUS server and secret, and enables RADIUS
# Note: passing secret as a command line parameter is a security
vulnerability
# Usage:
#   script_cli_radius.py <RADIUS server> <RADIUS secret>
#

import subprocess
import datetime
import sys

num_args = len(sys.argv) - 1
if num_args < 2:
    print("Usage: script_cli_radius.py <RADIUS server> <RADIUS secret>")
    sys.exit(1)

print("Settings RADIUS server on SLC at ", end="")
now = datetime.datetime.now()
print(now.strftime("%Y-%m-%d %H:%M"))

server = sys.argv[1]
secret = sys.argv[2]

proc = subprocess.Popen(['clisession', '-U', 'sysadmin'],
                        stdin=subprocess.PIPE,
                        stdout=subprocess.PIPE,
                        stderr=subprocess.PIPE)

# wait for prompt
while True:
    output_str = proc.stdout.readline()
    if b'list of commands' in output_str:
        proc.stdin.write(b'\n')
        proc.stdin.flush()
    if b']> ' in output_str:
        break
    if b'Invalid local user' in output_str:
        print("Invalid local user passed to clisession.")
        proc.stdin.close()
        proc.terminate()
        proc.wait()
        sys.exit(1)

# Run the RADIUS command
s = "set radius server 1 host " + server + " secret " + secret + "\n"
b = bytearray(s.encode())
proc.stdin.write(b)
proc.stdin.flush()

```

```

while True:
    output_str = proc.stdout.readline()
    if b'RADIUS settings successfully updated' in output_str:
        break
    elif b'set radius' not in output_str:
        # RADIUS command returned an error
        s1 = str(output_str)
        s2 = s1.split("\r")[1]
        print("RADIUS command returned: " + s2.split("\n")[0])
        proc.stdin.close()
        proc.terminate()
        proc.wait()
        sys.exit(1)

proc.stdin.write(b'set radius state enable\n')
proc.stdin.flush()
while True:
    output_str = proc.stdout.readline()
    if b'RADIUS settings successfully updated' in output_str:
        break
    elif b'set radius' not in output_str:
        # RADIUS command returned an error
        s1 = str(output_str)
        s2 = s1.split("\r")[1]
        print("RADIUS command returned: " + s2.split("\n")[0])
        proc.stdin.close()
        proc.terminate()
        proc.wait()
        sys.exit(1)

print("RADIUS settings updated and enabled.")
proc.stdin.close()
proc.terminate()
proc.wait()
sys.exit(0)

```

Python Custom Script - SLB CLI Session

An example of a Python Custom Script that uses the Pexpect module to interact with the CLI session and the device ports to detect the prompt on any devices connected to the SLB, and set the device port name to be the same as the device prompt:

```

#! python
# Script to detect the prompt on a device connected to a SLC or SLB
device port,
# and set the device port name to the prompt. Punctuation characters are
# removed and the device port number is appended to the name. Prompts
ending
# in '>' are detected. For example, for a Cisco device attached to device
# port 3 and displays this prompt:
#   engcisco_cat3560>
# the name for device port 3 will be set to "engcisco_cat3560-3"

```

```

import pexpect
import datetime
import time
import sys
import re

now = datetime.datetime.now()
print("Detecting devices on SLC at ", end="")
print(now.strftime("%Y-%m-%d %H:%M"))

# start the CLI session to get number of device ports
p=pexpect.spawn('clisession -U sysadmin')

slcPrompt = ""
numPorts = 0
loggedIn = False

while not loggedIn:
    i = p.expect([pexpect.TIMEOUT, pexpect.EOF,
                 'Model Number: SLC80(\\d*)\\r\\n', 'Model Number:
SLB882\\r\\n',
                 '\\[.*>\\]', timeout=10)
    if i == 0: # Timeout
        print("Timeout waiting to login.")
        p.terminate(True)
        sys.exit(1)
    elif i == 1: # EOF
        print("Session unexpectedly terminated.")
        p.terminate(True)
        sys.exit(1)
    elif i == 2: # SLC8000 model number
        model = p.match.group(1)
        numPorts = int(model)
    elif i == 3: # SLB882 model number
        numPorts = 8
    elif i == 4: # prompt
        loggedIn = True
        slcPrompt = p.match.group(1).decode('utf-8')

if numPorts == 0:
    print("Cannot determine number of device ports.")
    p.terminate(True)
    sys.exit(1)

print("Number of device ports:", numPorts)

# Terminate the CLI session
p.sendline("logout")
time.sleep(.500)
p.wait()

skipPorts = False
devicePort = 1

```



```

pList = []

if numPorts == 24 or numPorts == 40:
    # Adjust port numbering for SLC8024 and SLC8040
    skipPorts = True
    numPorts = numPorts + 8

# Loop through device ports, connect and try to detect the prompt
while devicePort <= numPorts:
    if skipPorts and devicePort >= 9 and devicePort <= 16:
        devicePort = devicePort + 1
        pList.append('')
        continue
    print("Scanning device port", devicePort, "...")
    port = str(devicePort)
    p=pexpect.spawn('portsession', ['-p', port])

    # Login (if required), and wait for the first prompt
    p.sendline("")
    gotPrompt = False
    slcDevice = False
    cnt = 1
    while not gotPrompt:
        i = p.expect([pexpect.TIMEOUT, pexpect.EOF,
                     'login:', 'Error: (.*)\r\n',
                     '>'], timeout=10)
        if i == 0:      # Timeout
            cnt = cnt + 1
            if cnt == 3:
                print("Timeout waiting to connect to DP", devicePort, ".")
                p.terminate(True)
                p.wait()
                break
            # may need to send a CR to get prompt
            p.send("\r")
        elif i == 1:   # EOF
            print("portsession on DP ", devicePort, "unexpectedly
terminated.")
            break
        elif i == 2:   # login prompt
            p.sendline("sysadmin")
            p.expect("Password:")
            p.sendline("PASS")
            slcDevice = True
            gotPrompt = True
        elif i == 3:   # error from portsession
            print(p.match.group(1).decode('utf-8'))
            p.terminate(True)
            p.wait()
            break
        elif i == 4:   # prompt
            gotPrompt = True
    # end if while not gotPrompt:

```

```

if not gotPrompt:
    devicePort = devicePort + 1
    pList.append('')
    continue

# Detect the prompt
devPrompt = ""
p.send("\n")
i = p.expect([pexpect.TIMEOUT, pexpect.EOF, '\r\n(.*)>'],
timeout=10)
if i == 0 or i == 1: # Timeout or EOF
    print("Timeout waiting for the prompt on DP", devicePort, ".")
    p.terminate(True)
    p.wait()
    devicePort = devicePort + 1
    pList.append('')
    continue
if i == 2: # prompt
    devPrompt = p.match.group(1).decode('utf-8')

if devPrompt == "":
    print("Timeout waiting for the prompt on DP", devicePort, ".")
    devicePort = devicePort + 1
    pList.append('')
    continue

print("Detected prompt", devPrompt, ".")
# Strip characters not allowed in DP names
devPromptStrip = re.sub("[^0-9A-Za-z\._\-\]", "", devPrompt)
devPromptComplete = devPromptStrip + "-" + str(devicePort)
pList.append(devPromptComplete)

p.terminate(True)
p.wait()
devicePort = devicePort + 1
# end of while devicePort <= numPorts:

# Connect to the SLC CLI and set the device port names
p=pexpect.spawn('clisession -U sysadmin')

loggedIn = False
while not loggedIn:
    i = p.expect([pexpect.TIMEOUT, pexpect.EOF,
'Model Number: SLC80(\d*)\r\n', 'Model Number:
SLB882\r\n',
'(\[.*>)\'], timeout=10)
    if i == 0: # Timeout
        print("Timeout waiting to login.")
        p.terminate(True)
        sys.exit(1)
    elif i == 1: # EOF
        print("Session unexpectedly terminated.")
        p.terminate(True)
        sys.exit(1)

```

```

elif i == 4: # prompt
    loggedIn = True

devicePort = 1
while devicePort <= numPorts:
    if skipPorts and devicePort >= 9 and devicePort <= 16:
        devicePort = devicePort + 1
        continue
    if len(pList[devicePort - 1]) > 0:
        # Detected a prompt; set it
        print("Setting name on DP", devicePort, "to", pList[devicePort -
1], "...")
        s = "set deviceport port " + str(devicePort) + " name " +
pList[devicePort - 1]
        p.sendline(s)
        i = p.expect([pexpect.TIMEOUT,
            'Device Port settings successfully updated.\r\n'],
            timeout=10)
        if i == 0: # Timeout
            print("Timeout waiting for response.")
        devicePort = devicePort + 1

# Terminate the CLI session
p.sendline("logout")
time.sleep(.500)
p.wait()
print("Script completed.")
sys.exit(0)

```

Tcl Custom Script - SLB CLI Session

An example of a Tcl Custom Script that interacts with a CLI session:

```

#! tcl
# Script to get the current internal temperature of the SLB
# Accepts one optional command line parameter for location

set slcTemp "unknown"
set location ""

# Are there any command line parameters?
if {$argc > 0} {
    set location [lindex $argv 0]
}

set now [clock seconds]
set date [clock format $now -format {%D %R}]
if {$argc > 0} {
    puts "Internal temperature of the $location SLC at $date"
} else {
    puts "Internal temperature of the SLC at $date"
}

```

```
set io [open "| clisession -U sysadmin" r+]

set loggedIn false
while {! $loggedIn} {
    set len [gets $io line]
    if {[string first "Invalid local user" $line] != -1} {
        puts "Invalid local user passed to clisession"
        break
    }
    if {[string first "For a list of commands" $line] != -1} {
        puts $io "\n"
        flush $io
    }
    if {[string first ">" $line] != -1} {
        set loggedIn true
    }
}

if {! $loggedIn} {
    exit 1
}

puts $io "show temp"
flush $io
set gotTemp false
while {! $gotTemp} {
    set len [gets $io line]
    if {[string first "Current Internal Temperature" $line] != -1} {
        set slcTemp [string range $line [expr {[string first ":" $line] +
1}] end]
        set gotTemp true
    }
}

puts "Temperature: $slcTemp"

puts $io "logout"
flush $io
exit 0
```

Sites

A site is a group of site-oriented modem parameters that can be activated by various modem-related events (authentication on dial-in, outbound network traffic for a dial-on-demand connection, etc.). The site parameters will override parameters that are configured for a modem.

To use sites with a modem, create one or more sites (described below), then enable **Use Sites** for the modem. Sites can be used with the following modem states: dial-in, dial-back, CBCP Server, dial-on-demand, dial-in & dial-on-demand, and dial-back & dial-on-demand. For more information on how sites are used with each modem state, see [Modem Dialing States on page 167](#).

Figure 8-21 Devices > Sites

The screenshot shows the LANTRONIX SLB882/8824 web interface. At the top, there is a navigation menu with tabs for Network, Services, User Authentication, Devices, Maintenance, and Quick Setup. The 'Devices' tab is selected, and the 'Sites' option is highlighted in the sub-menu. The main content area shows the 'Sites' configuration page. It includes a table with columns for 'Id' and 'Name', and buttons for 'View Site' and 'Delete Site'. Below the table, there are configuration fields for Site Id, Site Name, Port, Login/CHAP Host, CHAP Secret, Authentication, Timeout Logins, Negotiate IP Address, Static Route IP Address, Static Route Subnet Mask, Static Route Gateway, Dial-out Number, Dial-out Login, Dial-out Password, Retype Password, Dial-back Number, Allow Dial-back, Dial-back Delay, Dial-back Retries, Modem Timeout, Restart Delay, CBCP Server, Allow No Callback, and Enable NAT.

To add a site:

1. Click the **Devices** tab and select the **Sites** option. The Sites page displays:
2. In the lower section of the page, enter the following:

Note: To clear fields in the lower part of the page, click the **Reset Site** button.

Site Id (view only)	Displays after a site is created.
Site Name	Enter a name for the site.

Port	Select the Device Port or the USB Port the site is assigned to. For dial-on-demand sites, a port must be selected. For any other sites, the port selection can be set to None . See Modem Dialing States on page 167 .
Login/CHAP Host	The login name (for PAP authentication) or CHAP host (for CHAP authentication) associated with this site. If a modem has sites enabled and the authentication is successful at dial-in (for modem states dial-in, dial-back, CBCP server, dial-in & dial-on-demand, or dial-back & dial-on-demand), and the name that was authenticated matches the Login/CHAP Host, the site parameters will be used for the remainder of the modem connection.
CHAP Secret	The CHAP secret associated with this site. If a modem has sites enabled and CHAP authentication enabled, then at dial-in, if the remote server sends a name in the CHAP challenge response that matches the CHAP host of a site, the CHAP secret for the site will be used to authenticate the CHAP challenge response sent by the remote server.
Authentication	The type of authentication, PAP or CHAP , for which this site is applicable. On dial-in authentication, only sites with the authentication type that matches the authentication type configured for the modem will be used to try to find a matching site.
Timeout Logins	For text dial-in connections, the connection can time out after the connection is inactive for a specified number of minutes.
Negotiate IP Address	If the SLB branch office manager and the remote server should negotiate the IP addresses for each side of the PPP connection, select Yes . Select No if the address of the SLB unit (Local IP) and remote server (Remote IP) need to be specified.
Static Route IP Address	The Static Route IP Address, Subnet Mask and Gateway must be configured for dial-on-demand sites. The SLB device will automatically dial-out and establish a PPP connection when IP traffic destined for the network specified by the static route needs to be sent. Note: <i>Static Routing must be enabled on the Network - Routing page for dial-on-demand connections.</i>
Static Route Subnet Mask	The subnet mask for a dial-on-demand connection.
Static Route Gateway	The gateway for a dial-on-demand connection.
Dial-out Number	The dial-out number must be specified for dial-on-demand sites. This indicates the phone number to dial when the SLB branch office manager needs to send IP traffic for a dial-on-demand connection.
Dial-out Login	User ID for authentication when dialing out to a remote system. May have up to 32 characters. This ID is used for authenticating the SLB unit during the dial-out portion of a dial-back (including CBCP server) and dial-on-demand.
Dial-out Password	Enter the password for authentication when dialing out to a remote system. May have up to 64 characters. This password is used for authenticating the SLB unit during the dial-out portion of a dial-back (including CBCP server) and dial-on-demand.
Retype Password	Re-enter the password for authentication when dialing out to a remote system. May have up to 64 characters. This password is used for authenticating the SLB branch office manager during the dial-out portion of a dial-back (including CBCP server) and dial-on-demand.
Dial-back Number	The phone number to dial on callback for text or PPP dial-back connections. A site must successfully authenticate, have Allow Dial-back enabled and have a Dial-back Number defined in order for the site to be used for callback.
Allow Dial-back	If enabled, the site is allowed to be used for dial-back connections.
Dial-back Delay	For dial-back and CBCP Server, the number of seconds between the dial-in and dial-out portions of the dialing sequence.

Dial-back Retries	For dial-back and CBCP Server, the number of times the SLB unit will retry the dial-out portion of the dialing sequence if the first attempt to dial-out fails.
Modem Timeout	Timeout for dial-in and dial-on-demand PPP connections. Select Yes (default) for the SLB device to terminate the connection if no traffic is received during the configured idle time. Enter a value of from 1 to 9999 seconds. The default is 30 seconds.
Restart Delay	The number of seconds after the modem timeout and before the SLB branch office manager attempts another connection. The default is 30 seconds.
CBCP Server Allow No Callback	For a CBCP Server site, allows "No Callback" as an option in the CBCP handshake in addition to User-defined Number and Admin-defined Number.
Enable NAT	Select to enable Network Address Translation (NAT) for PPP connections. <i>Note: IP forwarding must be enabled on the Network - Settings page for NAT to work.</i>

3. Click the **Add Site** button.

To view or update a site:

1. In the **Sites** table, select the site and click the **View Site** button. The site attributes are displayed in the bottom half of the page.
2. Update any of the site attributes.
3. Click the **Edit Site** button.

To delete a site:

1. Select the site in the **Sites** table.
2. Click the **Delete Site** button.

Configures a set of site-oriented modem parameters that can be activated by various modem-related events (authentication, outbound network traffic for DOD connections, etc.).

The site parameters will override any parameters configured for the modem.

Uses sites with a modem, enable 'usesites'. Sites can be used with the following modem states: dialin, dialback, cbcpserver, dialondemand, dialin+ondemand, and dialback+ondemand.

Site Commands

Go to [Site Commands \(on page 323\)](#) to view CLI commands which correspond to the web page entries described above.

Modem Dialing States

This section describes the modem states and the options that are used for each modem state. For a description of modem states that can be used with sites, see [Sites](#).

Dial-In

The SLB unit waits for a peer to call the SLB device to establish a text (command line) or PPP connection.

- ◆ For text connections, the user will be prompted for a login and password, and will be authenticated via the currently enabled authentication methods (Local Users, NIS, LDAP, etc). Once authenticated, a CLI session will be initiated, and the user will remain connected to the

SLB unit until they either logout of the CLI session, or (if Timeout Logins is enabled) the CLI session is terminated if it has been idle.

- ◆ For PPP connections, the user will be authenticated via PAP or CHAP (configured with the Authentication setting). For PAP, the Local/Remote User list will be used to authenticate the login and password sent by the PPP peer. For CHAP, the CHAP Handshake Host/User Name and Secret/User Password will be used to authenticate the CHAP Challenge response sent by the PPP peer. If the remote peer requests PAP or CHAP authentication from the SLB unit, the Remote/Dial-out Login and Remote/Dial-out Password will be provided as authentication tokens. Once authenticated, a PPP session will be established using either negotiated IP addresses or specific IP addresses (determined by the Negotiate IP Address setting). The PPP connection will stay active until no IP traffic is sent for Modem Timeout seconds.

Dial-Out

The SLB unit dials a remote peer to establish a PPP connection. The SLB device dials the Dial-out Number, and if the remote peer requests PAP or CHAP authentication, provides the Remote/Dial-out Login and Remote/Dial-out Password as authentication tokens. Once authenticated, a PPP session will be established using either negotiated IP addresses or specific IP addresses (determined by the Negotiate IP Address setting).

Dial-Back

The SLB unit waits for a peer to call the device, establishes a text (command line) or PPP connection, authenticates the user, and if the SLB unit is able to determine a dial-back number to use, hangs up and calls the dial-back number to establish either a text or PPP connection.

- ◆ For text connections, the user will be prompted for a login and password, and will be authenticated via the currently enabled authentication methods (Local Users, NIS, LDAP, etc). Once authenticated, the SLB unit will use the Dial-back Number configured for the modem - either a fixed number assigned to the modem, or a number associated with the user that was authenticated (the user must have Allow Dial-back enabled and a Dial-back Number defined). If the SLB device can determine a dial-back number to use, it will hang up and wait Dial-back Delay seconds before initiating the dial-back. The SLB unit will dial, prompt the user again for a login and password, and a CLI session will be initiated (if the dial-back fails, the SLB unit will try Dial-back Retries times to dial-back). The user will remain connected to the SLB unit until they either logout of the CLI session, or (if Timeout Logins is enabled) the CLI session is terminated if it has been idle.
- ◆ Special SLM (Secure Lantronix Management Appliance) Text Dial-back support. When the SLM unit is configured for SLB unit callback support, the SLM device dials the SLB. The SLM will provide the callback number in a text string (DIALBACK #) to the modem that the SLM it is currently using. The SLB will hang up and wait Dial-back Delay seconds before initiating the dial-back to the SLM unit using the phone number provided above.
- ◆ For PPP connections, the user will be authenticated via PAP or CHAP (configured with the Authentication setting). For PAP, the Local/Remote list will be used to authenticate the login and password sent by the PPP peer. For CHAP, the CHAP Handshake Host/User Name and Secret/User Password will be used to authenticate the CHAP Challenge response sent by the PPP peer. If the remote peer requests PAP or CHAP authentication from the SLB device, the Remote/Dial-out Login and Remote/Dial-out Password will be provided as authentication tokens. Once authenticated, the SLB unit will use the Dial-back Number configured for the modem - either a fixed number assigned to the modem, or a number associated with the user that was authenticated (the user must have Allow Dial-back enabled and a Dial-back Number defined). If the SLB device can determine a dial-back number to use, it will hang up and wait

Dial-back Delay seconds before initiating the dial-back. The SLB unit will dial, and if the remote peer requests PAP or CHAP authentication, provide the Remote/Dial-out Login and Remote/Dial-out Password as authentication tokens. Once authenticated, a PPP session will be established using either negotiated IP addresses or specific IP addresses (determined by the Negotiate IP Address setting).

Dial-On-Demand

The SLB device automatically dial outs and establishes a PPP connection when IP traffic destined for a remote network needs to be sent. It will remain connected until no data packets have been sent to the peer for a specified amount of time. The modem cannot be configured for Negotiate IP Address - it must be configured with a Local IP and a Remote IP as the PPP connection will be established when it sees IP traffic destined for the Remote IP. When this occurs, the SLB unit dials the Dial-out Number, and if the remote peer requests PAP or CHAP authentication, provides the Remote/Dial-out Login and Remote/Dial-out Password as authentication tokens. Once authenticated, a PPP session will be established using the Local IP and the Remote IP. The PPP connection will stay active until no IP traffic for the Remote IP is sent for Modem Timeout seconds. Once the timeout has expired, the PPP connection will be terminated and will not be reestablished for at least Restart Delay seconds.

Dial-In & Dial-On-Demand

A modem is configured to be in two modes: answering incoming calls to establish a PPP connection, and automatically dialing out to establish a PPP connection when IP traffic destined for a remote network needs to be sent. When either event occurs (an incoming call or IP traffic destined for the remote network), the other mode will be disabled. The modem cannot be configured for Negotiate IP Address - it must be configured with a Local IP and a Remote IP as the PPP connection will be established when it sees IP traffic destined for the Remote IP.

- ◆ For Dial-in, the user will be authenticated via PAP or CHAP (configured with the Authentication setting). For PAP, the Local/Remote list will be used to authenticate the login and password sent by the PPP peer. For CHAP, the CHAP Handshake Host/User Name and Secret/User Password will be used to authenticate the login and password sent by the PPP peer. If the remote peer requests PAP or CHAP authentication from the SLB unit, the Remote/Dial-out Login and Remote/Dial-out Password will be provided as authentication tokens. Once authenticated, a PPP session will be established using the Local IP and the Remote IP. The PPP connection will stay active until no IP traffic is sent for Modem Timeout seconds.
- ◆ For Dial-on-Demand, the PPP connection will be established when it sees IP traffic destined for the Remote IP. When this occurs, the SLB unit dials the Dial-out Number, and if the remote peer requests PAP or CHAP authentication, provides the Remote/Dial-out Login and Remote/Dial-out Password as authentication tokens. Once authenticated, a PPP session will be established using the Local IP and the Remote IP. The PPP connection will stay active until no IP traffic for the Remote IP is sent for Modem Timeout seconds. Once the timeout has expired, the PPP connection will be terminated and will not be reestablished for at least Restart Delay seconds.

Dial-Back & Dial-On-Demand

A modem is configured to be in two modes: answering incoming calls to initiate a dial-back, and automatically dialing out to establish a PPP connection when IP traffic destined for a remote network needs to be sent. When either event occurs (an incoming call or IP traffic destined for the remote network), the other mode will be disabled. The modem cannot be configured for Negotiate IP Address - it must be configured with a Local IP and a Remote IP as the PPP connection will be established when it sees IP traffic destined for the Remote IP.

- ◆ For Dial-back, the user will be authenticated via PAP or CHAP (configured with the Authentication setting). For PAP, the Local/Remote list will be used to authenticate the login and password sent by the PPP peer. For CHAP, the CHAP Handshake Host/User Name and Secret/User Password will be used to authenticate the CHAP Challenge response sent by the PPP peer. If the remote peer requests PAP or CHAP authentication from the SLB unit, the Remote/Dial-out Login and Remote/Dial-out Password will be provided as authentication tokens. Once authenticated, the SLB device will use the Dial-back Number configured for the modem - either a fixed number assigned to the modem, or a number associated with the user that was authenticated (the user must have Allow Dial-back enabled and a Dial-back Number defined). If the SLB device can determine a dial-back number to use, it will hang up and wait Dial-back Delay seconds before initiating the dial-back (if the dial-back fails, the SLB unit will try Dial-back Retries times to dial-back). The SLB unit will dial, and if the remote peer requests PAP or CHAP authentication, provide the Remote/Dial-out Login and Remote/Dial-out Password as authentication tokens. Once authenticated, a PPP session will be established using the Local IP and the Remote IP.
- ◆ For Dial-on-Demand, the PPP connection will be established when it sees IP traffic destined for the Remote IP. When this occurs, the SLB dials the Dial-out Number, and if the remote peer requests PAP or CHAP authentication, provides the Remote/Dial-out Login and Remote/Dial-out Password as authentication tokens. Once authenticated, a PPP session will be established using the Local IP and the Remote IP. The PPP connection will stay active until no IP traffic for the Remote IP is sent for Modem Timeout seconds. Once the timeout has expired, the PPP connection will be terminated and will not be reestablished for at least Restart Delay seconds.

Dial-In/Host List

The SLB waits for a peer to call and establishes a text (command line) connection to the first host in a Host List that connects. A host list is a prioritized list of SSH, Telnet or raw TCP hosts to connect to. If Authentication is enabled for the Host List, the user will be prompted for a login and password, and will be authenticated via the currently enabled authentication methods (Local Users, NIS, LDAP, etc). Once authenticated, the SLB will try to connect to each host in the host list until a successful connection is established.

CBCP Server and CBCP Client

Callback Control Protocol (CBCP) is a PPP option that negotiates the use of callback where the server, after authenticating the client, terminates the connection and calls the client back at a phone number that is determined by the CBCP handshake. For more information on CBCP, see <http://technet.microsoft.com/en-us/library/cc957979.aspx>. CBCP is used primarily by Microsoft PPP peers. CBCP supports two options for determining the number to dial on callback: the client can specify a user-defined number for the server to dial on callback, or the client can request the server use an administrator-defined number to dial on callback. Optionally, some servers may also allow "no callback" as an option.

CBCP Server

The SLB unit waits for a client to call it, establish a PPP connection, authenticate the user, and negotiate a dial-back number with the client using CBCP. If the SLB unit is able to determine a dial-back number to use, it hangs up and calls the dial-back number.

When a call is received, a PPP connection is established, and the user will be authenticated via PAP or CHAP (configured with the Authentication setting). For PAP, the Local/Remote list will be used to authenticate the login and password sent by the PPP peer. For CHAP, the CHAP Handshake Host/User Name and Secret/User Password will be used to authenticate CHAP

Challenge response sent by the PPP peer. If the remote peer requests PAP or CHAP authentication from the SLB unit, the Remote/Dial-out Login and Remote/Dial-out Password will be provided as authentication tokens. Once authenticated, the CBCP handshake with the client determines the number to use for dial-back. The SLB device will present the client with the available options: if the authenticated user is a Local/Remote User with Allow Dial-back enabled and a Dial-back Number defined, the administrator-defined option is allowed; if this is not the case, the user-defined number is allowed. Additionally, if CBCP Server Allow No Callback is enabled, the client can also select no callback (the PPP connection established at dial-in will remain up). The client will select from the available callback options. If the SLB unit can determine a dial-back number to use, it will hang up and wait Dial-back Delay seconds before initiating the dial-back (if the dial-back fails, the SLB will try Dial-back Retries times to dial-back). The SLB device will call back the previously authenticated remote peer, and if the remote peer requests PAP or CHAP authentication, provide the Remote/Dial-out Login and Remote/Dial-out Password as authentication tokens. Once authenticated, a PPP session will be established using either negotiated IP addresses or specific IP addresses (determined by the Negotiate IP Address setting).

CBCP Client

The SLB unit will dial out to a CBCP server, establish a PPP connection, negotiate a callback number with the server using CBCP, terminate the connection, and wait for the server to call back. The SLB device dials the Dial-out Number, and if the remote peer requests PAP or CHAP authentication, provides the Remote/Dial-out Login and Remote/Dial-out Password as authentication tokens. Once authenticated, the CBCP handshake with the server determines the number to use for dial-back. The SLB device will request the type of number defined by CBCP Client Type - either an Admin-defined Number (the CBCP server determines the number to call) or a User-defined Number (the SLB unit will provide the Fixed Dial-back Number as the number to call). If the CBCP handshake is successful, the SLB unit will terminate the PPP connection, hang up, and wait for the server to dial back. When the remote server calls back the SLB unit and the PPP connection is established, the user will be authenticated via PAP or CHAP (configured with the Authentication setting). For PAP, the Local/Remote list will be used to authenticate the login and password sent by the PPP peer. For CHAP, the CHAP Handshake Host/User Name and Secret/User Password will be used to authenticate CHAP Challenge response sent by the PPP peer. Once authenticated, a PPP session will be established using either negotiated IP addresses or specific IP addresses (determined by the Negotiate IP Address setting).

Notes:

- ◆ *In a state where the modem will be answering a call, the modem should always be configured for manual answer, not auto answer.*
- ◆ *When answering a call, the SLB unit answers after the 2nd ring.*
- ◆ *Any text or PPP connection can be terminated by setting the modem state to disabled.*

9: USB Port

This chapter describes how to configure storage by using the [Devices > USB](#) page and CLI. This page can be used to configure the thumb drive and modems. The thumb drive is useful for saving and restoring configurations and for Device Port Logging. See [Device Port Settings \(on page 115\)](#).

This chapter describes the Web Manager pages and available CLI commands that configure the SLB branch office manager USB. For information about quick setup, installation, services, device ports, connections, user authentication, and maintenance tasks, see those chapters. This chapter contains the following sections:

- ◆ Set Up of USB Storage
- ◆ Manage Firmware and Configuration Files

Set Up of USB Storage

The [Devices > USB](#) page has an USB Access checkbox. USB Access is a security feature ensures that access to any USB device is disabled if the box is unchecked. The SLB unit ignores any USB device plugged into the port.

To set up USB storage in the SLB device, perform the following steps.

1. Insert any of the supported thumb drives into the USB port on the front of the SLB branch office manager . You can do this before or after powering up the SLB unit.
2. Log into the SLB branch office manager and click **Devices**.
3. Click **USB**. [Figure 9-1](#) shows the page that displays. Your USB device should display in Port U1 if you have inserted it. If it does not display and you have inserted it, refresh the web page.

Figure 9-1 Devices > USB

The screenshot shows the LANTRONIX SLB882/8824 web interface. At the top, there is a navigation menu with tabs for Network, Services, User Authentication, Devices, Maintenance, and Quick Setup. Below the navigation menu, there is a section titled 'USB' with a 'Help?' link. The main content area features a table titled 'USB Ports' with a 'Configure' button. The table has columns for Port, Device, Type, and State. The first row shows Port U1 with a modem device, type 'Manufacturer=U.S.Robotics Product=USB Modem SerialNumber=0000003', and state 'inserted'. The second row shows Port U2 with a modem device, type 'Internal', and state 'N/A'. Below the table, there is a 'USB Access' checkbox which is checked, and an 'Apply' button.

Port	Device	Type	State	
U1	modem	Manufacturer=U.S.Robotics Product=USB Modem SerialNumber=0000003	inserted	<input type="radio"/>
U2	modem	Internal	N/A	<input type="radio"/>

USB Access:

Apply

If a USB device has been inserted, but is not visible in the table, please refresh the web page.

To configure the settings for a USB device, select the radio button in the right column.

To configure the USB port, from the USB Ports table:

1. Click the radio button (on the far right) for a USB port.

- Click **Configure**. *Figure 9-2* shows the page that displays if a USB storage device is inserted in the selected port.



- Enter the following fields.

Mount	Enables the first partition of the USB device (if not currently mounted). Once mounted, a device is used for device port logging and saving/restoring configurations.
Unmount	Enables ejecting the USB device. Warning: <i>If you eject a USB device from the SLB branch office manager without unmounting it, subsequent mounts may fail, and you will need to reboot the SLB unit to restore the functionality.</i>
Format	Select to: <ul style="list-style-type: none"> ◆ Unmount the USB device (if it is mounted) ◆ Remove all existing partitions ◆ Create one partition ◆ Format it with the selected file system (ext2 or FAT) ◆ Mount the USB device
Filesystem	Select Ext2 or a FAT file system the SLB branch office manager supports.

- Click **Apply**.

To configure the USB Modem port, from the Modem USB Ports table:

- Click the radio button (on the far right) for Port U1 or U2.
- Click **Configure**. *Figure 9-3* shows the page that displays if a USB modem is inserted in Port U1, or if Port U2 is selected.

Figure 9-3 Devices > USB > Modem

LANTRONIX® SLB882

Logout Host: slb8Ref_120-6100 User: sysadmin

Select port for Configuration WebSSH (DP only) Connected Device (DP only)

Network Services User Authentication **Devices** Maintenance Quick Setup

Device Status Device Ports Console Port USB Power Outlets Connections Host Lists Scripts Sites

USB - Modem Help?

Port: U2 State: **Disabled** [View Modem Log](#)

Device: **Modem** Mode: Text PPP PPP Logging:

Type: **Internal** Use Sites: PPP Debug:

State: **N/A** Group Access:

Note: Dial-out GPRS connections may replace the default route and DNS entries. [Static Routes](#) may be required to maintain access to subnets that are not directly attached to the SLB.

Initialization Script:

Modem Timeout: No Yes, seconds (1-9999):

Caller ID Logging: Modem Command:

Dial-back Number: Local User Number Fixed Number:

Dial-back Delay: seconds

Dial-back Retries:

Check Dial Tone: No Yes, minutes (5-600):

Data Settings

Baud: 115200

Data Bits: 8

Parity: none

Stop Bits: 1

Flow Control: rts/cts

GSM/GPRS Settings

Dial-out Mode: GPRS GSM

PIN:

Retype PIN:

PPP Compression:

Auto-acquire DNS:

Negotiated IP: **N/A**

GPRS Context: AT+CGDCONT=1,"IP","[Acco

GSM Bearer Svc: AT+CBST=7,0

Text Mode

Timeout Logins: No Yes, minutes (1-30):

Dial-in Host List: undefined [Host Lists](#)

PPP Mode

Negotiate IP Address: Yes No Local IP: Remote IP:

Authentication: PAP CHAP

CHAP Handshake: Host/User Name: Secret/User Password:

CHAP Auth Uses: CHAP Host Local Users Same authentication for Dial-in & Dial-on-Demand (DOD):

DOD Authentication: PAP CHAP

DOD CHAP Handshake: Host/User Name: Secret/User Password:

Enable NAT: **Note:** Enabling NAT requires [IP Forwarding](#) to be enabled.

Dial-out Number:

Remote/Dial-out Login:

Remote/Dial-out Pwd: Retype:

Restart Delay: 30 seconds

CBCP Server Allow No Callback:

CBCP Client Type: Admin-defined Number User-defined Number

IP Settings

Service: None Telnet SSH TCP

Telnet Port: 2050 Authenticate:

SSH Port: 3050 Authenticate:

TCP Port: 4050 Authenticate:

3. Enter the following fields.

Data Settings

Note: Check the modem's equipment settings and documentation for the proper settings. The attached modem must have the same settings.

Baud	The speed with which the device port exchanges data with the attached serial device. From the drop-down list, select the baud rate. Most devices use 9600 for the administration port, so the device port defaults to this value. Check the equipment settings and documentation for the proper baud rate.
Data Bits	Number of data bits used to transmit a character. From the drop-down list, select the number of data bits. The default is 8 data bits.
Parity	Parity checking is a rudimentary method of detecting simple, single-bit errors. From the drop-down list, select the parity. The default is none .
Stop Bits	The number of stop bit(s) used to indicate that a byte of data has been transmitted. From the drop-down list, select the number of stop bits. The default is 1 .
Flow Control	A method of preventing buffer overflow and loss of data. The available methods include none , xon/xoff (software), and RTS/CTS (hardware). The default is none .

GSM/GPRS Settings

Dial-out Mode	Select either GPRS or GSM (Global System for Mobile communication) as the type of dial-out connection.
PIN	Enter PIN (personal identification number) for accessing the GSM/GPRS card.
Retype PIN	Re-enter PIN (personal identification number) for accessing the GSM/GPRS card.
PPP Compression	Select to enable negotiation of data compression over PPP links. Disabled by default.
Auto-acquire DNS	Select to enable the SLB branch office manager to acquire up to three DNS servers by means of GPRS (General Packet Radio Service). Enabled by default.
Negotiated IP	IP address associated with the GPRS connection.
GPRS Context	Command to specify the protocol data packet (PDP) context parameter values.
GSM Bearer Svc	Command to select the bearer service, data rate, and connection element to use when data call originate.

Modem Settings

Note: Depending on the **State** and **Mode** you select, different fields are available.

State	Indicates whether an external modem is attached to the device port. If enabling, set the modem to dial-out, dial-in, dial-back, dial-on-demand, dial-in/host list, or dial in & dial-on-demand. Disabled by default.
--------------	--

Mode	<p>The format in which the data flows back and forth:</p> <ul style="list-style-type: none"> ◆ Text: In this mode, the SLB unit assumes that the modem will be used for remotely logging into the command line. Text mode can only be used for dialing in or dialing back. Text is the default. ◆ PPP: This mode establishes an IP-based link over the modem. PPP connections can be used in dial-out mode (e.g., the SLB device connects to an external network), dial-in mode (e.g., the external computer connects to the network that the SLB branch office manager is part of), dial-back (dial-in followed by dial-out), CBCP server and CBCP client.
Use Sites	<p>Enables the use of site-oriented modem parameters which can be activated by various modem-related events (authentication, outbound network traffic for dial-on-demand connections, etc.). Sites can be used with the following modem states: dial-in, dial-back, dial-on-demand, dial-in & dial-on-demand, dial-back & dial-on-demand, and CBCP server.</p> <p>For more information, see Sites on page 165.</p>
Group Access	<p>If undefined, any group can access the modem (text login only). If one or more groups are specified (groups are delimited by the characters ' ' (space), ',' (comma), or ';' (semicolon)), then any user who logs into the modem must be a member of one of the specified groups, otherwise access will be denied. Users authenticated via RADIUS may have a group (or groups) provided by the RADIUS server via the Filter-Id attribute that overrides the group defined for a user on the SLB. A group provided by a remote server must be either a single group or multiple groups delimited by the characters ' ' (space), ',' (comma), ';' (semicolon), or '=' (equals) - for example "group=group1,group2;" or "group1,group2,group3".</p>
Initialization Script	<p>Commands sent to configure the modem may have up to 100 characters. Consult your modem's documentation for recommended initialization options. If you do not specify an initialization script, the SLB device uses a default initialization string of</p> <pre>AT S7=45 SO=0 L1 V1 X4 &D2 &c1 E1 Q0.</pre> <p>Note: We recommend that the modem initialization script always be preceded with AT and include E1 V1 x4 Q0 so that the SLB unit may properly control the modem.</p>
Modem Timeout	<p>Timeout for all modem connections. Select Yes (default) for the SLB branch office manager to terminate the connection if no traffic is received during the configured idle time. Enter a value of from 1 to 9999 seconds. The default is 30 seconds.</p>
Caller ID Logging	<p>Select to enable the SLB unit to log caller IDs on incoming calls. Disabled by default.</p> <p>Note: For the Caller ID AT command, refer to the modem user guide.</p>
Modem Command	<p>Modem AT command used to initiate caller ID logging by the modem.</p> <p>Note: For the AT command, refer to the modem user guide.</p>
Dial-back Number	<p>Users with dial-back access can dial into the SLB device and enter their login and password. Once the SLB branch office manager authenticates them, the modem hangs up and dials them back.</p> <p>Select the phone number the modem dials back on -a fixed number or a number associated with their login. If you select Fixed Number, enter the number (in the format 2123456789).</p> <p>The dial-back number is also used for CBCP client as the number for a user-defined number. See Device Ports - Settings (on page 113) for more information.</p>
Dial-back Delay	<p>For dial-back and CBCP Server, the number of seconds between the dial-in and dial-out portions of the dialing sequence.</p>

Dial-back Retries	Specify the number of times to retry dialing back.
Check Dial Tone	If enabled, the SLB branch office manager will periodically check the modem for a dial tone while waiting for a dial in (ie, if the Modem State is set to Dial-in, or if the Modem State is set to Dial-back and the SLB unit is in the Dial-in portion of the sequence). The SLB device can issue a trap or an event can be setup to notify the user if no dial tone is detected. Enabled by default (every 15 minutes).

Text Mode

Timeout Logins	If you selected Text mode, you can enable logins to time out after the connection is inactive for a specified number of minutes. The default is No . This setting is only applicable for text mode connections. PPP mode connections stay connected until either side drops the connection. Disabled by default.
Dial-in Host List	From the drop-down list, select the desired host list. The host list is a prioritized list of SSH, Telnet, and TCP hosts that are available for establishing outgoing modem connections or for connect direct at the CLI. The hosts in the list are cycled through until the SLB branch office manager successfully connects to one. To establish and configure host lists, click the Host Lists link.

PPP Mode

Negotiate IP Address	If the SLB unit and/or the serial device have dynamic IP addresses (e.g., IP addresses assigned by a DHCP server), select Yes . Yes is the default. If the SLB device or the modem have fixed IP addresses, select No , and enter the Local IP (IP address of the port) and Remote IP (IP address of the modem).
Authentication	Enables PAP or CHAP authentication for modem logins. PAP is the default. With PAP, users are authenticated by means of the Local Users and any of the remote authentication methods that are enabled. With CHAP, the CHAP Handshake fields authenticate the user.
CHAP Handshake	The Host/User Name (for UNIX systems) or Secret/User Password (for Windows systems) used for CHAP authentication. May have up to 128 characters.
CHAP Auth Uses	For CHAP authentication, determines what is used to validate the CHAP host/user sent by the remote peer: either the CHAP Host defined for the modem, or any of the users in the Local Users list.
Same authentication for Dial-in & Dial-on-Demand (DOD)	Select this option to let incoming connections (dial-in) use the same authentication settings as outgoing connections (dial-on-demand). If this option is not selected, then the dial-on-demand connections take their authentication settings from the DOD parameter settings. If DOD Authentication is PAP , then the DOD CHAP Handshake field is not used.
DOD Authentication	Enables PAP or CHAP authentication for dial-in & dial-on-demand. PAP is the default. With PAP, users are authenticated by means of the Local Users and any of the remote authentication methods that are enabled. With CHAP, the DOD CHAP Handshake fields authenticate the user.
DOD CHAP Handshake	For DOD Authentication , enter the Host/User Name for UNIX systems) or Secret/User Password (for Windows systems) used for CHAP authentication. May have up to 128 characters.

Enable NAT	Select to enable Network Address Translation (NAT) for dial-in and dial-out PPP connections on a per modem (device port or USB port) basis. Users dialing into the SLB unit access the network connected to Eth1 and/or Eth2. <i>Note: IP forwarding must be enabled on the Network > Network Settings (bottom of page) page for NAT to work. See Chapter 6: Basic Parameters on page 58.</i>
Dial-out Number	Phone number for dialing out to a remote system or serial device. May have up to 20 characters. Any format is acceptable.
Remote/Dial-out Login	User ID for dialing out to a remote system. May have up to 32 characters.
Remote/Dial-out Pwd	Enter password for dialing out to a remote system. May have up to 64 characters.
Retype	Re-enter password for dialing out to a remote system. May have up to 64 characters.
Restart Delay	The number of seconds after the timeout and before the SLB branch office manager attempts another connection. The default is 30 seconds.
CBCP Server Allow No Callback	For CBCP Server state, allows "No Callback" as an option in the CBCP handshake in addition to User-defined Number and Admin-defined Number.
CBCP Client Type	For CBCP Client, this selects the number that the client would like to use for callback - either a user-defined number passed to the server (specified by the Fixed Dial-back Number) or an administrator-defined number determined by the server based on the login that is PAP or CHAP authenticated.

IP Settings

Service	The available connection services for this modem port (Telnet, SSH, or TCP). Only one can be active at a time. The default is None.
Telnet Port	Telnet Port Telnet session port number to use if you selected Telnet. Defaults: <ul style="list-style-type: none"> ◆ USB Port U1: 2049 ◆ USB Port U2: 2050 ◆ Range: 1025-65535
SSH Port	The SSH session port number to use if you selected SSH. Defaults: <ul style="list-style-type: none"> ◆ USB Port U1: 3049 ◆ USB Port U2: 3050 ◆ Range: 1025-65535
TCP Port	The TCP (raw) session port number to use if you selected TCP. Defaults: <ul style="list-style-type: none"> ◆ USB Port U1: 4049 ◆ USB Port U2: 4050 ◆ Range: 1025-65535
Authenticate (checkbox)	If selected, the SLB unit requires user authentication before granting access to the port. Authenticate is selected by default for Telnet Port and SSH Port , but not for TCP Port .

4. Click **Apply**.

Manage Firmware and Configuration Files

To manage any firmware and configuration files stored on a USB thumb drive, perform the following steps.

1. Click the **Manage Files on the Thumb Drive** link on the [Devices > USB > Configure](#) page.

Figure 9-4 Firmware and Configurations - Manage Files (Top of Page)

The screenshot shows the LANTRONIX SLB882/8824 web interface. At the top, there is a navigation bar with tabs for Network, Services, User Authentication, Devices, Maintenance, and Quick Setup. Below this is a sub-navigation bar with links for Device Status, Device Ports, Console Port, USB, Power Outlets, Connections, Host Lists, Scripts, and Sites. The main content area is titled 'Firmware & Configurations - Manage Files' and includes a 'Back to USB - Storage' link. A table titled 'Files - USB Port U1' lists the following files:

Name	Date/Time Saved	SSH Keys	SSL Certificate	Scripts	
slcupdate-db-5.6a.tgz	01/24/13 17:54:54	N/A	N/A	N/A	<input type="checkbox"/>
slc3256a1-slccfg.tgz	02/01/13 19:27:24	N	N	N	<input type="checkbox"/>
slcupdate-db-6.1.tgz	03/06/13 15:13:52	N/A	N/A	N/A	<input type="checkbox"/>
slbvc7-slccfg.tgz	03/08/13 20:48:26	Y	Y	Y	<input type="checkbox"/>
slbrc8-slccfg.tgz	03/10/13 07:12:38	Y	Y	Y	<input type="checkbox"/>
test-slccfg.tgz	03/12/13 18:36:22	Y	Y	Y	<input type="checkbox"/>
lock-cli-slccfg.tgz	03/14/13 19:02:20	Y	Y	Y	<input type="checkbox"/>
printerdrivers.bin	07/09/14 02:40:20	N/A	N/A	N/A	<input type="checkbox"/>
xPrintServerBackup.bin	07/09/14 03:08:32	N/A	N/A	N/A	<input type="checkbox"/>

Below the table are three buttons: 'Delete File', 'Download File', and 'Rename File'. To the right of these buttons is a text input field labeled 'New File Name:'.

Note: At the bottom of the page, shown in [Figure 9-4](#), are the **Delete**, **Download**, and **Rename** options.

2. To delete a file, click the check box next to the filename and click **Delete File**. A confirmation message displays.
3. To download a file, click the **Download File** button. Select the file from the list.
4. To rename a file, click the check box next to the filename and enter a new name in the **New File Name** field.
5. Click **Rename File**.

USB Commands

Go to [USB Storage Commands \(on page 330\)](#) and [USB Modem Commands \(on page 331\)](#) to view CLI commands which correspond to the web page entries described above.

10: Connections

[Chapter 8: Device Ports](#) described how to configure and interact with an SLB device port connected to an external device. This chapter describes how to use the [Devices > Connections](#) page to connect external devices and outbound network connections (such as Telnet or SSH) in various configurations.

An SLB device port attached to an external device can be connected to one of the following endpoints:

- ◆ Another device port attached to an external device
- ◆ Another device port with a modem attached
- ◆ An outgoing Telnet or SSH session
- ◆ An outgoing TCP or UDP network connection

This enables the user to set up connections such as those described in the next section. You can establish a connection at various times:

- ◆ Immediately. These connections are always re-established after reboot.
- ◆ At a specified date and time. These connections connect if the date and time have already passed.
- ◆ After a specified amount of data or a specified sequence of data passes through the connection. Following reboot, the connection is not reestablished until the specified data passes through the connection.

Typical Setup Scenarios for the SLB

Following are typical configurations in which SLB connections can be used, with references to settings on the [Devices > Connections](#) and [Device Ports > Settings](#) web pages.

Terminal Server

In this setup, the SLB branch office manager acts as a multiplexer of serial data to a single server computer. Terminal devices are connected to the serial ports of the SLB and configured as a Device Port to Telnet out type connection on the [Devices > Connections](#) page. The users of the terminals can access the server as if they were connected directly to it by local serial ports or a console.

Figure 10-1 Terminal Server

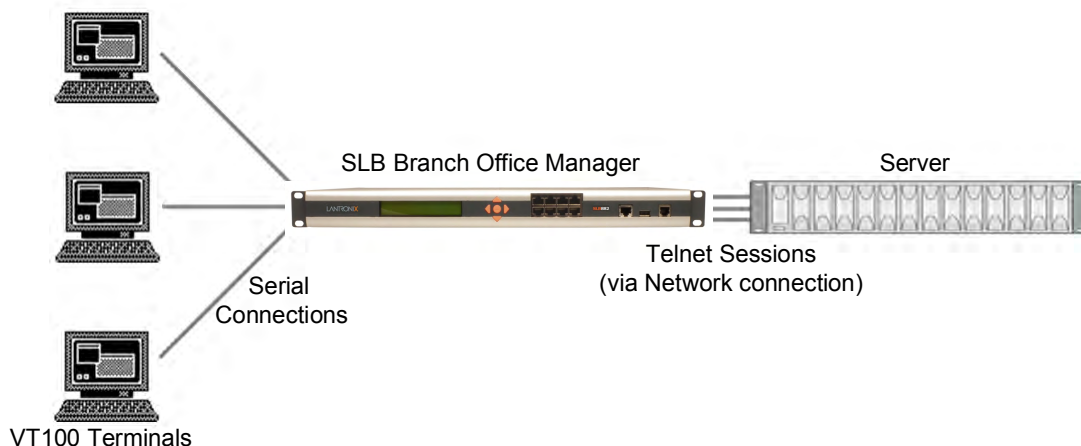

Remote Access Server

In this setup, the SLB unit is connected to one or more modems by its device ports. Configure the device ports on the [Device Ports > Settings](#) web page by selecting the Dial-in option in the Modem Settings section. Most customers use the modems in PPP mode to establish an IP connection to the SLB branch office manager and either Telnet or SSH into the SLB unit. They could also select text mode where, using a terminal emulation program, a user could dial into the SLB device and connect to the command line interface.

Figure 10-2 Remote Access Server



Reverse Terminal Server

In this scenario, the SLB branch office manager has one or more device ports connected to one or more serial ports of a mainframe server. Users can access a terminal session by establishing a Telnet or SSH session to the SLB unit. To configure the SLB device, select the **Enable Telnet In** or **Enable SSH In** option on the [Device Ports > Settings](#) page.

Figure 10-3 Reverse Terminal Server

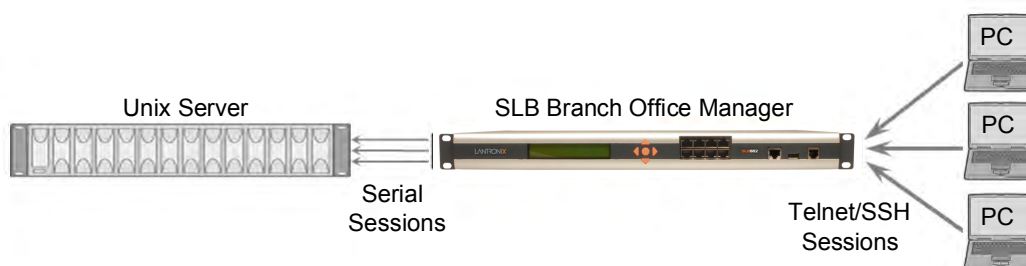

Multiport Device Server

A PC can use the device ports on the SLB branch office manager as virtual serial ports, enabling the ports to act as if they are local ports to the PC. To use the SLB unit in this setup, the PC requires special software, for example, Com Port Redirector (available on www.lantronix.com) or similar software).

Figure 10-4 Multiport Device Server



Console Server

For this situation, the SLB device is configured so that the user can manage a number of servers or pieces of network equipment using their console ports. The device ports on the SLB branch office manager are connected to the console ports of the equipment that the user would like to manage. To manage a specific piece of equipment, the user can Telnet or SSH to a specific port or IP address on the SLB unit and be connected directly to the console port of the end server or device. To configure this setup, set the **Enable Telnet In** or **Enable SSH In** option on the [Device Ports > Settings](#) page for the device port in question. The user can implement an extra remote management capability by adding a modem to one of the device ports and setting the **Dial-in** option in the Modem Settings section of the [Device Ports > Settings](#) page. A user could then dial into the SLB device using another modem and terminal emulation program at a remote location.

Console Server

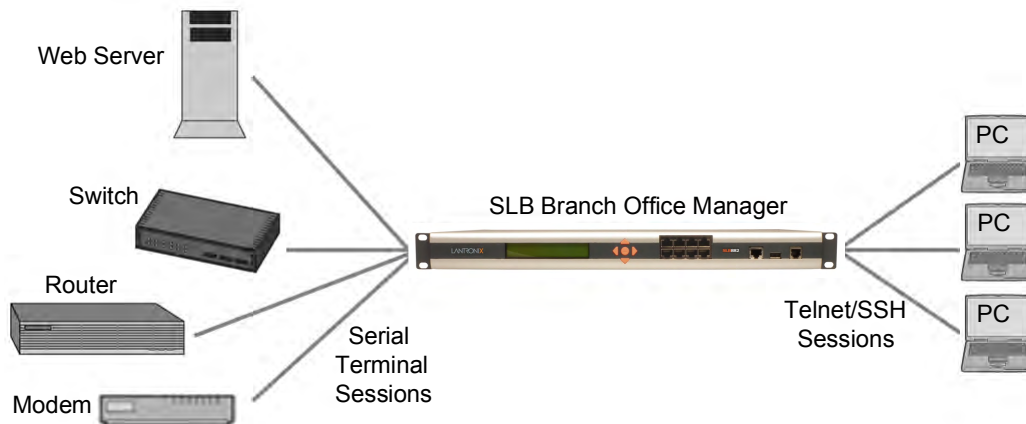

Connection Configuration

To create a connection:

1. Click the **Devices** tab and select the **Connections** option. The following page displays:

Figure 10-5 Devices > Connections

The screenshot shows the LANTRONIX SLB882/8824 web interface. At the top, there's a navigation bar with tabs: Network, Services, User Authentication, Devices, Maintenance, and Quick Setup. The 'Devices' tab is active, and the 'Connections' sub-tab is selected. The main content area is titled 'Connections' and contains several configuration options:

- Outgoing Connection Timeout:** Radio buttons for 'No' and 'Yes' (selected), with a text input field set to '5' seconds.
- Connect: Device Port:** A 'Port' input field with a 'Settings' link.
- Data Flow:** Three radio buttons with arrows indicating bidirectional, left-to-right, and right-to-left flow. The bidirectional option is selected.
- to:** A dropdown menu set to 'Device Port'.
- Hostname:** A text input field.
- Port:** A text input field with a 'Settings' link.
- SSH Out Options:**
 - User:** A text input field.
 - Version:** Radio buttons for 'None', '1', and '2'. 'None' is selected.
 - Command:** A text input field.
- Trigger:**
 - Connect now:** Selected radio button.
 - Connect at date/time:** A date/time picker set to September 18, 2001, 02:00 am.
 - Auto-connect on characters transferring:** Radio buttons for 'at least' and 'character sequence'. 'at least' is selected, with a text input field for 'characters'.

At the bottom, there's an 'Apply' button. Below the configuration area is a table titled 'Current Connections' with columns for 'Port/Service', 'Flow', 'Port/Service', 'User', and 'Time'. The table contains one entry: 'Console Port' with a bidirectional flow, 'Command Line' service, 'N/A' user, and a time of '69:46:45'. There are 'Configure', 'Terminate', and 'Restart' buttons for this entry.

2. For a device port, enter the following:

Outgoing Connection Timeout	Select to turn on or turn off the connection timeout: <ul style="list-style-type: none"> ◆ No for no timeout ◆ Yes for a timeout. Specify the number of seconds in the seconds field.
Port	The number of the device port you are connecting. This device port must be connected to an external serial device and must not have command line interface logins enabled, be connected to a modem, or be running a loopback test. Note: To see the current settings for this device port, click the Settings link.
Data Flow	Select the arrow showing the direction (bidirectional or unidirectional) the data will flow in relationship to the device port you are connecting.

to	From the drop-down list, select a destination for the connection: a device port connected to a serial device, a device port connected to a modem, or an outbound network connection (Telnet, SSH, TCP Port, or UDP Port). Note: To see the current settings for a selected device port, click the Settings link.
Hostname	The host name or IP Address of the destination. This entry is required if the to field is set to Telnet out, SSH out, TCP port, or UDP port.
Port	If the to field is set to Device Port or Modem on Device Port , enter the number of the device port. For all other options, this is the TCP/UDP port number, which is optional for Telnet out and SSH out, but required for TCP Port and UDP Port. Note: If you select Device Port , it must not have command line interface logins enabled or be running a loopback test. To view the device port's settings, click the Settings link to the right of the port number.
SSH Out Options	Select one of the following optional flags to use for the SSH connection. <ul style="list-style-type: none"> ◆ User: Login ID to use for authenticating on the remote host. ◆ Version: Version of SSH. Select 1 or 2. ◆ Command: Enter a specific command on the remote host (for example, reboot).
Trigger	Select the condition that will trigger a connection. Options include: <ul style="list-style-type: none"> ◆ Connect now: Connects immediately, or if you reboot the SLB, immediately on reboot. ◆ Connect at date/time: Connects at a specified date and time. Use the drop-down lists to complete the date and time. Upon rebooting, the SLB branch office manager reestablishes the connection if the date/time has passed. ◆ Auto-connect on characters transferring: Select the arrow indicating the direction of the data transfer and either the minimum number of characters or a specific character sequence that will trigger the connection. <p>You can select the direction of the data transfer only if Data Flow is bidirectional. Upon rebooting, the SLB unit does not reestablish the connection until the specified data has passed through one of the endpoints of the connection.</p>

3. To save, click the **Apply** button.

To view, update, or disconnect a current connection:

The bottom of the [Current Connections](#) page displays current connections.

Figure 10-6 Current Connections

To view details for a connection, hold the mouse over the arrow icon in the Flow column
 If a connection can be modified, the fields above will be filled in; modify the connection and select 'Configure'
 To terminate a connection, select the radio button in the right column below and select 'Terminate'
 Web connections can be viewed [here](#)

Port/Service	Flow	Port/Service	User	Time	
Console Port		Command Line	N/A	69:46:45	<input type="checkbox"/>

Current Connections Configure Terminate Keep Connection: Restart

1. To view details about a connection, hold the mouse over the arrow in the **Flow** column.
2. To disconnect (delete) a connection, select the connection in the check box column and click the **Terminate** button.
3. To update (or reconfigure) a connection, select the connection in the check box column, modify the attributes and click the **Configure** button.
4. To reestablish the connection, create the connection again in the top part of the page.

5. To reestablish a connection that has been suspended, select the connection and click the **Restart** button.
6. To view information about Web connections, click the [here](#) link in the text above the table. The [Maintenance > Firmware & Configurations](#) page displays.

Connection Commands

Go to [Connection Commands \(on page 283\)](#) to view CLI commands which correspond to the web page entries described above.

11: User Authentication

Users who attempt to log in to the SLB branch office manager by means of Telnet, SSH, the console port, or one of the device ports are granted access by one or more authentication methods.

The User Authentication page provides a submenu of methods (Local Users, NIS, LDAP, RADIUS, Kerberos, and TACACS+) for authenticating users attempting to log in. Use this page to assign the order in which the SLB unit will use the methods. By default, local user authentication is enabled and is the first method the SLB device uses to authenticate users. If desired, you can disable local user authentication or assign it a lower precedence.

Note: *Regardless of whether local user authentication is enabled, the local user sysadmin account is always available for login. For security purposes, full administrative access to the SLB via the default sysadmin local user account can be limited to only the front console port of the SLB device. See [Limiting Sysadmin User Access \(on page 45\)](#).*

Authentication can occur using all methods, in the order of precedence, until a successful authentication is obtained, or using only the first authentication method that responds (in the event that a server is down).

If you have the same user name defined in multiple authentication methods, the result is unknown.

Example:

There is an LDAP user "joe" and an NIS user "joe" and the order of authentication methods is:

1. Local Users
2. LDAP
3. NIS

User "joe" tries to log in. Because there is an LDAP user "joe," the SLB branch office manager tries to authenticate him against his LDAP password first. If he fails to log in, then the SLB unit may (or may not) try to authenticate him against his NIS "joe" user password.

To enable, disable, and set the precedence of authentication methods:

1. From the main menu, select **User Authentication**. The following page displays:

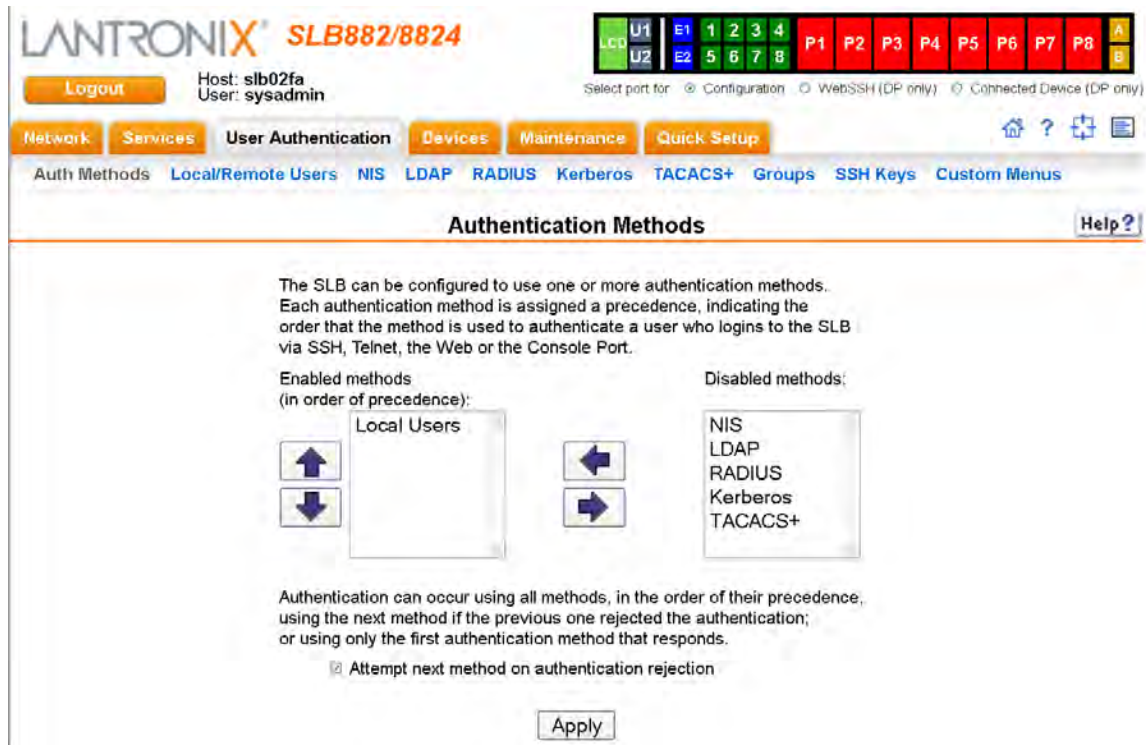

Figure 11-1 User Authentication > Authentication Methods



2. To enable a method currently in the **Disabled methods** list, select the method and press the left  arrow to the left of the list. The methods include:

<p>NIS (Network Information System)</p>	<p>A network naming and administration system developed by Sun Microsystems for smaller networks. Each host client or server computer in the system has knowledge about the entire system. A user at any host can access files or applications on any host in the network with a single user identification and password.</p> <p>NIS uses the client/server model and the Remote Procedure Call (RPC) interface for communication between hosts. NIS consists of a server, a library of client programs, and some administrative tools. NIS is often used with the Network File System (NFS).</p>
<p>LDAP (Lightweight Directory Access Protocol)</p>	<p>A set of protocols for accessing information directories, specifically X.500-based directory services. LDAP runs over TCP/IP or other connection-oriented transfer services.</p>
<p>RADIUS (Remote Authentication Dial-In User Service)</p>	<p>An authentication and accounting system used by many Internet Service Providers (ISPs). A client/server protocol, it enables remote access servers to authenticate dial-in users and authorize their access to the requested system or service.</p> <p>RADIUS allows a company to maintain user profiles in a central database that all remote servers can share. It increases security, allowing a company to set up a policy that can be applied at a single administered network point.</p>

Kerberos	Kerberos is a network authentication protocol that enables two parties to exchange private information across an unprotected network. It works by assigning a unique electronic credential, called a ticket, to each user who logs on to the network. The ticket is embedded in messages to identify the sender.
TACACS+ (Terminal Access Controller Access Control System)	TACACS+ allows a remote access server to communicate with an authentication server to determine whether the user has access to the network. TACACS+ is a completely new protocol and is not compatible with TACACS or XTACACS. The SLB unit supports TACACS+ only.

3. To disable a method currently in the **Enabled methods** list, select the method and click the right  arrow between the lists.
4. To set the order in which the SLB branch office manager will authenticate users, use the up  and down  arrows to the left of the **Enabled methods** list.
5. For **Attempt next method on authentication rejection**, you have the following options:
 - ◆ To enable the SLB unit to use all methods, in order of precedence, until it obtains a successful authentication, select the check box. This is the default.
 - ◆ To enable the SLB unit to use only the first authentication method that responds (in case a server is down or unavailable), clear the check box.
6. Click **Apply**.

Now that you have enabled one or more authentication methods, you must configure them.

Authentication Commands

Go to [Authentication Commands \(on page 267\)](#) to view CLI commands which correspond to the web page entries described above.

Local and Remote User Settings

The system administrator can configure the SLB branch office manager to use local accounts and remote accounts to authenticate users.

1. Click the **User Authentication** tab and select the **Local/Remote Users** option. The following page displays.

Figure 11-2 User Authentication > Local/Remote Users

The screenshot shows the LANTRONIX SLB882/8824 configuration interface. The 'User Authentication' tab is selected, and the 'Local/Remote Users' sub-tab is active. The page includes a navigation bar with tabs for Network, Services, User Authentication, Devices, Maintenance, and Quick Setup. Below the navigation bar, there are several configuration sections:

- Local/Remote Users:** Contains checkboxes for 'Enable Local Users' (checked), 'Multiple Sysadmin Web Logins' (checked), 'Sysadmin Access Limited to Console Port' (unchecked), and 'Authenticate only remote users who are in the remote users list' (unchecked). A note states: 'Local and remote accounts on the SLB are used to authenticate users who login to the SLB via SSH, Telnet, the Web or the Console Port. Note: remove Escape & Break Sequences for users making raw binary connections to Device Ports.'
- Local User Passwords:** Contains fields for 'Complex Passwords' (unchecked), 'Allow Reuse' (checked), 'Reuse History' (4), 'Password Lifetime' (90 days), 'Warning Period' (Yes: 7 days), 'Max Login Attempts' (Yes: 0), and 'Lockout Period' (Yes: 0 minutes).
- User Management:** Includes 'Add/Edit User' and 'Delete User' buttons. A note says: 'Select the radio button in the right column to edit or delete a user. Shaded users are locked (cannot login).'
- User Table:** A table titled 'Local Users (1 users) & Remote Users (0 users)' with columns: Login, Auth, UID, Group, Permissions, Esc Seq, Brk Seq, Custom Menu, DB, Listen, Data, Clear, and Outlet. One user is listed: 'sysadmin' with 'Local' auth, UID '0', Group 'Adm', and various permissions.

The top of the page has entry fields for enabling local and remote users and for setting password requirements. The bottom of the page displays a table listing and describing all local and remote users.

To enable local and/or remote users:

2. Enter the following:

Enable Local Users	Select to enable all local users except sysadmin. The sysadmin is always available regardless of how you set the check box. Enabled by default.
Multiple Sysadmin Web Logins	Select to allow the sysadmin to have multiple simultaneous logins to the web interface. Disabled by default.
Sysadmin Access Limited to Console Port	Select to limit sysadmin logins to the physical SLB Console Port only. Disabled by default. Note: For security purposes, full administrative access to the SLB via the default sysadmin local user account can be limited to only the front console port of the SLB device. See Limiting Sysadmin User Access (on page 45) .

Authenticate only remote users who are in the remote users list	Select the check box to authenticate users listed in the Remote Users list in the lower part of the page. Disabled by default.
--	--

3. Continue to set **Local User Passwords**:

Complex Passwords	Select to enable the SLB unit to enforce rules concerning the password structure (e.g., alphanumeric requirements, number of characters, punctuation marks). Disabled by default. Complexity rules: Passwords must be at least eight characters long. They must contain one upper case letter (A-Z), one lower case letter (a-z), one digit (0-9), and one punctuation character (` ~ ! @ # \$ % ^ & * - + = \ } [] ; : " ' < > , . ? / _).
Allow Reuse	Select to enable users to continue to reuse old passwords. If you disable the check box, they cannot use any of the Reuse History number of passwords. Enabled by default.
Reuse History	The number of passwords the user must use before reusing an old password. The default is 4 . For example, if you set reuse history to 4, the user may reuse an old password after using 4 other passwords.
Password Lifetime (days)	The number of days until the password expires. The default setting is 90 .
Warning Period (days)	The number of days ahead that the system warns that the user's password will expire. The default setting is 7 .
Max Login Attempts	The number of times (up to 8) the user can attempt to log in unsuccessfully before the system locks the user out. The default setting is 0 (disabled).
Lockout Period (minutes)	The number of minutes (up to 90) the locked-out user must wait before trying to log in to the web interface again. The default setting is 0 (disabled).

4. Click the **Apply** button.

Adding, Editing or Deleting a User

Through this [User Authentication > Local/Remote Users](#) page, you can delete a user listed in the table or open a page for adding or editing a user.

To add a user:

1. On the [User Authentication > Local/Remote Users](#), click the **Add/Edit User** button. The [User Authentication > Local/Remote User > Settings](#) page displays.

Figure 11-3 User Authentication > Local/Remote User > Settings

The screenshot shows the 'Local/Remote User Settings' page for a user named 'sysadmin' on host 'slb02fa'. The page is divided into several sections:

- Header:** LANTRONIX SLB882/8824, Logout button, Host: slb02fa, User: sysadmin, and a port selection menu.
- Navigation:** Network, Services, User Authentication (selected), Devices, Maintenance, Quick Setup.
- Sub-navigation:** Auth Methods, Local/Remote Users (selected), NIS, LDAP, RADIUS, Kerberos, TACACS+, Groups, SSH Keys, Custom Menus.
- Local/Remote User Settings:**
 - Login:** Login field, Authentication: Local (selected) or Remote, UID: 101, Listen Ports: 1-8,U1,U2, Data Ports: 1-8,U1,U2, Clear Port Buffers: 1-8,U1,U2, Access Outlets: 1-8.
 - Enable for Dial-back:** Enable for Dial-back checkbox, Dial-back Number field, Escape Sequence: \x1bA, Break Sequence: \x1bB, Custom Menu: <none>, Display Menu at Login: checked.
 - Password:** Password field, Retype Password field, Password Expires checkbox, Allow Password Change: checked, Change Password on Next Login checkbox, Lock Account checkbox, Account Status: Active.
 - Group:** Group: Default Users (selected), Power Users, Administrators, Custom Group: <none>.
 - Permissions:** Full Administrative, Networking, Services, Secure Lantronix Network, Date/Time, Local Users, Remote Authentication, SSH Keys, User Menus, Web Access, Diagnostics & Reports, Reboot & Shutdown, Firmware & Configuration, Device Port Operations, Device Port Configuration, USB, Power Outlets.
- Footer:** Back to Local/Remote Users link, Apply button.

2. Enter the following information for the user:

Login	User ID of selected user.
Authentication	Select the type of authenticated user: <ul style="list-style-type: none"> ◆ Local: User listed in the SLB database. ◆ Remote: User not listed in the SLB database.

UID	<p>A unique numeric identifier the system administrator assigns to each user. Valid UIDs are 101-4294967295.</p> <p>Note: <i>The UID must be unique. If it is not, SLB branch office manager automatically increments it. Starting at 101, the SLB device finds the next unused UID.</i></p>
Listen Ports	The device ports that the user may access to view data using the <code>connect listen</code> command. Enter the port numbers or the range of port numbers (for example, 1, 5, 8, 10-15).
Data Ports	The device ports with which the user may interact using the <code>connect direct</code> command. Enter the port numbers or the range of port numbers.
Clear Port Buffers	The device port buffers the users may clear using the <code>set locallog clear</code> command. Enter the port numbers or the range of port numbers.
Access Outlets	The outlets the user may monitor and configure.
Enable for Dial-back	Select to grant a local user dial-back access. Users with dial-back access can dial into the SLB branch office manager and enter their login and password. Once the SLB unit authenticates them, the modem hangs up and dials them back. Disabled by default.
Dial-back Number	The phone number the modem dials back on depends on this setting for the device port. The user is either dialed back on a fixed number (specified on the Device Port - Settings page), or on a number that is associated with the user's login (specified here).
Escape Sequence	<p>A single character or a two-character sequence that causes the SLB unit to leave direct (interactive) mode. (To leave listen mode, press any key.)</p> <p>A suggested value is Esc+A (escape key, then uppercase "A" performed quickly but not simultaneously). You would specify this value as <code>\x1bA</code>, which is hexadecimal (<code>\x</code>) character 27 (1B) followed by an A.</p> <p>This setting allows the user to terminate the <code>connect direct</code> command on the command line interface when the endpoint of the command is <code>deviceport</code>, <code>tcp</code>, or <code>udp</code>.</p>
Break Sequence	A series of 1-10 characters users can enter on the command line interface to send a break signal to the external device. A suggested value is Esc+B (escape key, then uppercase "B" performed quickly but not simultaneously). You would specify this value as <code>\x1bB</code> , which is hexadecimal (<code>\x</code>) character 27 (1B) followed by a B .
Custom Menu	<p>If custom menus have been created, you can assign a default custom menu to the user. The custom menu will display at login.</p> <p>Note: <i>In the Local Users table, if the menu assigned to a local user no longer exists, it is marked with an asterisk (*).</i></p>
Display Menu at Login	If custom menus have been created, select to enable the menu to display when the user logs into the CLI.
Password / Retype Password	When a user logs into the SLB branch office manager, the SLB unit prompts for a password (up to 64 characters). The sysadmin establishes that password here.
Password Expires	If not selected, allows the user to keep a password indefinitely. If selected the user keeps the password for a set period. (See the section, Local and Remote User Settings (on page 189) for information on specifying the length of time before the password expires.)
Allow Password Change	Select to allow the user to change password.
Change Password on Next Login	Indicate whether the user must change the password at the next login.

Lock Account	Select to lock the account indefinitely.
Account Status	Displays the current account status: <ul style="list-style-type: none"> ◆ Active ◆ Locked ◆ Locked (invalid logins)

3. Assign rights to users. Each user is a member of a group that has a predefined user rights associated with it. You can assign or remove additional rights to the individual user.

Group	Select the group to which the user will belong: <ul style="list-style-type: none"> ◆ Default Users: This group has only the most basic rights. You can specify additional rights for the individual user . ◆ Power Users: This group has the same rights as Default Users plus Networking, Date/Time, Reboot & Shutdown, and Diagnostics & Reports. You can specify additional rights for the individual user. ◆ Administrators: This group has all possible rights. ◆ Custom Group: Select a custom group from the drop-down menu.
Full Administrative	Right to perform any function on the SLB.
Networking	Right to enter network and routing settings.
Services	Right to enable and disable system and audit logging, SSH and Telnet logins, SNMP, and SMTP. Includes NFS and CIFS.
Secure Lantronix Network	Right to view and manage secure Lantronix units (e.g., SLP, Spider or SLB units) on the local subnet.
Date/Time	Right to set the date and time.
Local Users	Right to add or delete local users on the system.
Remote Authentication	Right to assign a remote user to a user group and assign a set of rights to the user. Includes configuring remote authentication methods and ordering
SSH Keys	Right to set SSH keys for authenticating users.
User Menus	Right to create or edit a custom user menu for the CLI.
Web Access	Right to access Web-Manager.
Diagnostics & Reports	Right to obtain diagnostic information and reports about the unit.
Reboot & Shutdown	Right to shutdown or reboot the SLB.
Firmware & Configuration	Right to upgrade the firmware on the unit and save or restore a configuration (all settings).
Device Port Operations	Right to control device ports.
Device Port Configuration	Right to enter device port settings.
USB	Right to enter modem settings for the USB.
Power Outlets	Right to view and enter settings for power outlets.

4. Click the **Apply** button.
5. Click the **Back to Local/Remote Users** link to return to the Local/Remote User Settings page.
6. Add another user or click the **Back to Local/Remote Users** link. The Local/Remote Users page displays with the new user(s) listed in the table.

Note: *The logged-in user's name displays at the top of the web page. Only the tabs and options for which the user has rights display.*

Shortcut

To add a user based on an existing user:

1. Display the existing user on the Local/Remote Users Settings page. The fields in the top part of the page display the current values for the user.
2. Change the Login to that of the new user. It is best to change the Password too.
3. Click the **Apply** button.

To edit a local user:

1. On the Local/Remote Users page, select the user and click the **Add/Edit User** button. The Local/Remote User Settings page displays.
2. Update values as desired.
3. Click the **Apply** button.

To delete a local user:

1. On the Local/Remote Users page, select the user.
2. Click the **Delete User** button.
3. Click the **Apply** button.

To change the sysadmin password:

1. On the Local/Remote Users page, select **sysadmin** and click the **Add/Edit User** button. The Local/Remote User Settings page displays.
2. Enter the new password in the Password and Retype Password fields.

Note: You can change Escape Sequence and Break Sequence, if desired. You cannot delete the UID or change the UID, port permissions, or custom menu.

3. Click the **Apply** button.

Local Users Commands

Go to [Local Users Commands \(on page 271\)](#) to view CLI commands which correspond to the web page entries described above.

NIS

The system administrator can configure the SLB branch office manager to use NIS to authenticate users attempting to log in to the SLB unit through the Web, SSH, Telnet, or the console port. If NIS does not provide port permissions, you can use this page to grant device port access to users who are authenticated through NIS.

All NIS users are members of a group that has predefined user rights associated with it. You can assign additional user rights that are not defined by the group.

To configure the SLB device to use NIS to authenticate users:

1. Click the **User Authentication** tab and select the **NIS** option.

Figure 11-4 User Authentication > NIS

The screenshot displays the configuration interface for NIS authentication on a LANTRONIX SLB882/8824 device. The top navigation bar includes tabs for Network, Services, User Authentication (selected), Devices, Maintenance, and Quick Setup. The NIS configuration section includes:

- Enable NIS:** A checkbox that is currently unchecked.
- NIS Domain:** A text input field.
- Note:** The NIS Domain must match the NIS domain name on the NIS Server.
- Broadcast for NIS Server:** A checkbox that is currently unchecked.
- NIS Master Server:** A text input field.
- NIS Slave Server #1-5:** Five text input fields for configuring slave servers.
- Custom Menu:** A dropdown menu set to '<none>'. Below it are fields for **Escape Sequence** (set to '\x1bA') and **Break Sequence** (set to '\x1bB').
- Enable for Dial-back:** A checkbox that is currently unchecked.
- Dial-back Number:** A text input field.
- Data Ports:** A text input field set to '1-8,U1,U2'.
- Listen Ports:** A text input field set to '1-8,U1,U2'.
- Clear Port Buffers:** A text input field set to '1-8,U1,U2'.
- Access Outlets:** A text input field set to '1-8'.

The **User Rights** section includes:

- Group:** Radio buttons for 'Default Users' (selected), 'Power Users', and 'Administrators'.
- Full Administrative:** A checkbox that is currently unchecked.
- Networking:** A checkbox that is currently unchecked.
- Services:** A checkbox that is currently unchecked.
- Secure Lantronix Network:** A checkbox that is currently unchecked.
- Date/Time:** A checkbox that is currently unchecked.
- Local Users:** A checkbox that is currently unchecked.
- Remote Authentication:** A checkbox that is currently unchecked.
- SSH Keys:** A checkbox that is currently unchecked.
- User Menus:** A checkbox that is currently unchecked.
- Web Access:** A checkbox that is currently unchecked.
- Diagnostics & Reports:** A checkbox that is currently unchecked.
- Reboot & Shutdown:** A checkbox that is currently unchecked.
- Firmware & Configuration:** A checkbox that is currently unchecked.
- Device Port Operations:** A checkbox that is currently unchecked.
- Device Port Configuration:** A checkbox that is currently unchecked.
- USB:** A checkbox that is currently unchecked.
- Power Outlets:** A checkbox that is currently unchecked.

An **Apply** button is located at the bottom of the configuration section.

2. Enter the following:

Enable NIS	Displays selected if you enabled this method on the Authentication Methods page. If you want to set up this authentication method but not enable it immediately, clear the checkbox. <i>Note:</i> You can enable NIS here or on the first User Authentication page. If you enable NIS here, it automatically displays at the end of the order of precedence on the User Authentication page.
NIS Domain	The NIS domain of the SLB branch office manager must be the same as the NIS domain of the NIS server.
Broadcast for NIS Server	If selected, the SLB unit sends a broadcast datagram to find the NIS Server on the local network.

NIS Master Server (required)	The IP address or host name of the master server.
NIS Slave Servers #1 -5	The IP addresses or host names of up to five slave servers.
Custom Menu	If custom menus have been created you can assign a default custom menu to NIS users.
Escape Sequence	<p>A single character or a two-character sequence that causes the SLB device to leave direct (interactive) mode. (To leave listen mode, press any key.)</p> <p>A suggested value is Esc+A (escape key, then uppercase "A" performed quickly but not simultaneously). You would specify this value as \x1bA, which is hexadecimal (\x) character 27 (1B) followed by an A.</p> <p>This setting allows the user to terminate the connect direct command on the command line interface when the endpoint of the command is deviceport, tcp, or udp.</p>
Break Sequence	A series of 1-10 characters users can enter on the command line interface to send a break signal to the external device. A suggested value is Esc+B (escape key, then uppercase "B" performed quickly but not simultaneously). You would specify this value as \x1bB , which is hexadecimal (\x) character 27 (1B) followed by a B .
Enable for Dial-back	Select to grant a user <i>Dial-Back (on page 168)</i> . Users with dial-back access can dial into the SLB branch office manager and enter their login and password. Once the SLB device authenticates them, the modem hangs up and dials them back. Disabled by default.
Dial-back Number	The phone number the modem dials back on depends on this setting for the device port. The user is either dialed back on a fixed number, or on a number that is associated with the user's login (specified here).
Data Ports	The ports users are able to monitor and interact with using the connect direct command.
Listen Ports	The ports users are able to monitor using the connect listen command.
Clear Port Buffers	The ports whose port buffer users may clear using the set locallog clear command.
Access Outlets	The outlets the user may monitor and configure.

3. In the **User Rights** section, select the user **Group** to which NIS users will belong:

Group	<p>Select the group to which the NIS users will belong:</p> <ul style="list-style-type: none"> ◆ Default Users: This group has only the most basic rights. You can specify additional rights for the individual user . ◆ Power Users: This group has the same rights as Default Users plus Networking, Date/Time, Reboot & Shutdown, and Diagnostics & Reports. ◆ Administrators: This group has all possible rights.
--------------	--

4. Assign or unassign **User Rights** for the specific user by checking or unchecking the following checkboxes:

Full Administrative	Right to add, update, and delete all editable fields.
Networking	Right to enter Network settings.
Services	Right to enable and disable system logging, SSH and Telnet logins, SNMP, and SMTP.
Secure Lantronix Network	Right to view and manage secure Lantronix units (e.g., SLP, Spider, SLC and SLB units) on the local subnet.
Date/Time	Right to set the date and time.
Local Users	Right to add or delete local users on the system.

Remote Authentication	Right to assign a remote user to a user group and assign a set of rights to the user.
SSH Keys	Right to set SSH keys for authenticating users.
User Menus	Right to create a custom user menu for the CLI for NIS users.
Web Access	Right to access Web-Manager.
Diagnostics & Reports	Right to obtain diagnostic information and reports about the unit.
Reboot & Shutdown	Right to use the CLI or shut down the SLB branch office manager and then reboot it.
Firmware & Configuration	Right to upgrade the firmware on the unit and save or restore a configuration (all settings). Selecting this option automatically selects Reboot & Shutdown .
Device Port Operations	Right to control device port settings.
Device Port Configuration	Right to enter device port settings.
USB	Right to enter modem settings for USB devices.
Power Outlets	Right to configure power outlets.

5. Click the **Apply** button.

Note: You must reboot the unit before your changes will take effect.

NIS Commands

Go to [NIS Commands \(on page 275\)](#) to view CLI commands which correspond to the web page entries described above.

LDAP

The system administrator can configure the SLB branch office manager to use LDAP to authenticate users attempting to log in using the Web, Telnet, SSH, or the console port.

LDAP allows SLB users to authenticate using a wide variety of LDAP servers, such as OpenLDAP and Microsoft Active Directory. The LDAP implementation supports LDAP servers that do not allow anonymous queries.

Users who are authenticated through LDAP are granted device port access through the port permissions on this page.

All LDAP users are members of a group that has predefined user rights associated with it. You can add additional user rights that are not defined by the group.

To configure the SLB unit to use LDAP to authenticate users:

1. Click the **User Authentication** tab and select **LDAP**. The following page displays.

Figure 11-5 User Authentication > LDAP

2. Enter the following:

Enable LDAP	Displays selected if you enabled this method on the first User Authentication page. If you want to set up this authentication method but not enable it immediately, clear the checkbox.
Server	The IP address or host name of the LDAP server.

Port	Number of the TCP port on the LDAP server to which the SLB unit talks. The default is 389 .
Base	The name of the LDAP search base (e.g., dc=company, dc=com). May have up to 80 characters.
Bind Name	The name for a non-anonymous bind to an LDAP server. This item has the same format as LDAP Base. One example is cn=administrator,cn=Users,dc=domain,dc=com
Bind Password / Retype Password	Password for a non-anonymous bind. This entry is optional. Acceptable characters are a-z, A-Z, and 0-9 . The maximum length is 127 characters.
Bind with Login	Select to bind with the login and password that a user is authenticating with. This requires that the Bind Name contain the \$login token, which will be replaced with the current login. For example, if the Bind Name is uid=\$login,ou=People,dc=lantronix,dc=com, and user roberts logs into the SLB branch office manager, LDAP will bind with uid=roberts,ou=People,dc=lantronix,dc=com and the password entered by roberts.
User Login Attribute	The attribute used by the LDAP server for user logins. If nothing is specified for the user filter, the SLB unit will use "uid". For AD LDAP servers, the attribute for user logins is typically "sAMAccountName".
Group Filter Objectclass	The objectclass used by the LDAP server for groups. If nothing is specified for the group filter, the SLB device will use "posixGroup". For AD LDAP servers, the objectclass for groups is typically "Group".
Group Member Attribute	The attribute used by the LDAP server for group membership. This attribute may be used to search for a name (ie, "msmith") or a Distinguished Name (ie, "uid=msmith,ou=People,dc=lantronix,dc=com"). Select either Name or DN as appropriate for the LDAP server. If nothing is specified for the group membership attribute, the SLB branch office manager will use "memberUID" for name and "uniqueMember" for DN. For AD LDAP servers, the Group Membership Value is typically DN, with the Group Membership Attribute of "member".
Group Member Value	The attribute used by the LDAP server for group membership. This attribute may be used to search for a name (ie, "msmith") or a Distinguished Name (ie, "uid=msmith,ou=People,dc=lantronix,dc=com"). Select either Name or DN as appropriate for the LDAP server. If nothing is specified for the group membership attribute, the SLB unit will use "memberUID" for name and "uniqueMember" for DN. For AD LDAP servers, the Group Membership Value is typically DN, with the Group Membership Attribute of "member".
Use LDAP Schema	Select the check box to obtain remote user attributes (group/permissions and port access) from an Active Directory server's scheme via the user attribute 'Secure LantronixSLC Perms' (see details below). Disabled by default.
Active Directory Support	Select to enable. Active Directory is a directory service from Microsoft that is a part of Windows 2000 and later versions of Windows. It is LDAP- and Kerberos-compliant. Disabled by default.

Encrypt Messages	<p>Select Start TLS or SSL to encrypt messages between the SLB unit and the LDAP server. If Start TLS is selected, the port will automatically be set to 389 and the StartTLS extension will be used to initiate a secure connection; if SSL is selected, the port will automatically be set to 636 and a SSL tunnel will be used for LDAP communication. The port number can be changed to a non-standard LDAP port; if the port number is set to anything other than 636, Start TLS will be used as the encryption method. Disabled by default.</p> <p>A certificate can be uploaded to the SLB unit for peer authentication. The certificate file is a file of CA certificates in PEM format. The file can contain several CA certificates identified by:</p> <pre>-----BEGIN CERTIFICATE----- (CA certificate in base64 encoding) -----END CERTIFICATE-----</pre> <p>sequences. Before, between, and after the certificates text is allowed which can be used e.g. for descriptions of the certificates.</p>
Certificate	<p>Click the Upload File link to upload a certificate file to the SLB unit for peer authentication. The certificate file is a file of CA certificates in PEM format. The file can contain several CA certificates identified by:</p> <pre>-----BEGIN CERTIFICATE----- (CA certificate in base64 encoding) -----END CERTIFICATE-----</pre> <p>sequences. Before, between, and after the certificates text is allowed which can be used e.g. for descriptions of the certificates.</p>
Custom Menu	<p>If custom menus have been created, you can assign a default custom menu to LDAP users. (See Custom Menus on page 223.)</p>
Escape Sequence	<p>A single character or a two-character sequence that causes the SLB branch office manager to leave direct (interactive) mode. (To leave listen mode, press any key.)</p> <p>A suggested value is Esc+A (escape key, then uppercase "A" performed quickly but not simultaneously). You would specify this value as <code>\x1bA</code>, which is hexadecimal (<code>\x</code>) character 27 (1B) followed by an A.</p> <p>This setting allows the user to terminate the <code>connect direct</code> command on the command line interface when the endpoint of the command is deviceport, tcp, or udp.</p>
Break Sequence	<p>A series of 1-10 characters users can enter on the command line interface to send a break signal to the external device. A suggested value is Esc+B (escape key, then uppercase "B" performed quickly but not simultaneously). You would specify this value as <code>\x1bB</code>, which is hexadecimal (<code>\x</code>) character 27 (1B) followed by a B.</p>
Enable for Dial-back	<p>Select to grant a user dial-back access. Users with dial-back access can dial into the SLB unit and enter their login and password. Once the SLB device authenticates them, the modem hangs up and dials them back. Disabled by default.</p>
Dial-back Number	<p>The phone number the modem dials back on depends on this setting for the device port. The user is either dialed back on a fixed number, or on a number that is associated with the user's login (specified here).</p>
Data Ports	<p>The ports users are able to monitor and interact with using the <code>connect direct</code> command.</p>
Listen Port	<p>The ports users are able to monitor using the <code>connect listen</code> command.</p>
Clear Port Buffers	<p>The ports whose port buffer users may clear using the <code>set locallog clear</code> command.</p>
Access Outlets	<p>The outlets the user may monitor and configure.</p>

3. In the **User Rights** section, select the user group to which LDAP users will belong:

Group	Select the group to which the LDAP users will belong: <ul style="list-style-type: none"> ◆ Default Users: This group has only the most basic rights. You can specify additional rights for the individual user. ◆ Power Users: This group has the same rights as Default Users plus Networking, Date/Time, Reboot & Shutdown, and Diagnostics & Reports. ◆ Administrators: This group has all possible rights.
--------------	--

4. Select or clear the checkboxes for the following rights:

Full Administrative	Right to add, update, and delete all editable fields.
Networking	Right to enter Network settings.
Services	Right to enable and disable system logging, SSH and Telnet logins, SNMP, and SMTP.
Secure Lantronix Network	Right to view and manage secure Lantronix units (e.g., SLP, Spider and SLB units) on the local subnet.
Date/Time	Right to set the date and time.
Local Users	Right to add or delete local users on the system.
Remote Authentication	Right to assign a remote user to a user group and assign a set of rights to the user.
SSH Keys	Right to set SSH keys for authenticating users.
User Menus	Right to create a custom user menu for the CLI for LDAP users.
Web Access	Right to access Web-Manager.
Diagnostics & Reports	Right to obtain diagnostic information and reports about the unit.
Reboot & Shutdown	Right to use the CLI or shut down the SLB branch office manager and then reboot it.
Firmware & Configuration	Right to upgrade the firmware on the unit and save or restore a configuration (all settings). Selecting this option automatically selects Reboot & Shutdown .
Device Port Operations	Right to control device ports.
Device Port Configuration	Right to enter device port settings.
USB	Right to enter modem settings for USB devices.
Power Outlets	Right to configure power outlets.

5. Click the **Apply** button.

Note: You must reboot the unit before your changes will take effect.

LDAP Commands

Go to [LDAP Commands \(on page 270\)](#) to view CLI commands which correspond to the web page entries described above.

RADIUS

The system administrator can configure the SLB device to use RADIUS to authenticate users attempting to log in using the Web, Telnet, SSH, or the console port.

Users who are authenticated through RADIUS are granted device port access through the port permissions on this page.

All RADIUS users are members of a group that has predefined user rights associated with it. You can add additional user rights that are not defined by the group.

To configure the SLB branch office manager to use RADIUS to authenticate users:

1. Click the **User Authentication** tab and select **RADIUS**. The following page displays.

Figure 11-6 User Authentication > RADIUS

The screenshot shows the LANTRONIX SLB882/8824 configuration interface. At the top, there's a navigation bar with tabs for Network, Services, User Authentication (selected), Devices, Maintenance, and Quick Setup. Below this is a sub-menu with options like Auth Methods, Local/Remote Users, NIS, LDAP, RADIUS (selected), Kerberos, TACACS+, Groups, SSH Keys, and Custom Menu. The main content area is titled 'RADIUS' and contains several sections:

- Enable RADIUS:** A checkbox that is currently unchecked.
- RADIUS Server #1:** Fields for Server #1 Port (1812), Server #1 Secret, and RADIUS Server #2.
- RADIUS Server #2:** Fields for Server #2 Port (1812), Server #2 Secret, and Timeout (30 seconds).
- Use VSA:** A checkbox for 'for User Attributes and Permissions'.
- Custom Menu:** A dropdown menu set to '<none>'. Other fields include Escape Sequence (x1bA), Break Sequence (x1bB), Enable for Dial-back (unchecked), and Dial-back Number.
- Data Ports:** Field set to '1-8,U1,U2'.
- Listen Ports:** Field set to '1-8,U1,U2'.
- Clear Port Buffers:** Field set to '1-8,U1,U2'.
- Access Outlets:** Field set to '1-8'.

Below the RADIUS section is the **User Rights** section, which includes a 'Group' dropdown set to 'Default Users' and a list of permissions with checkboxes:

- Full Administrative:
- Networking:
- Services:
- Secure Lantronix Network:
- Date/Time:
- Local Users:
- Remote Authentication:
- SSH Keys:
- User Menus:
- Web Access:
- Diagnostics & Reports:
- Reboot & Shutdown:
- Firmware & Configuration:
- Device Port Operations:
- Device Port Configuration:
- USB:
- Power Outlets:

An 'Apply' button is located at the bottom of the User Rights section.

2. Enter the following:

Enable RADIUS	<p>Displays selected if you enabled this method on the User Authentication page. If you want to set up this authentication method but not enable it immediately, clear the checkbox.</p> <p>Note: You can enable RADIUS here or on the first User Authentication page. If you enable RADIUS here, it automatically displays at the end of the order of precedence on the User Authentication page.</p>
RADIUS Server #1	<p>IP address or hostname of the primary RADIUS server. This RADIUS server may be a proxy for SecurID.</p> <p>SecurID is a two-factor authentication method based on the user's SecurID token and pin number. The SecurID token displays a string of digits called a token code that changes once a minute (some tokens are set to change codes every 30 seconds).</p>
Server #1 Port	Number of the TCP port on the RADIUS server used for the RADIUS service. If you do not specify an optional port, the SLB unit uses the default RADIUS port (1812).
Server #1 Secret	Text that serves as a shared secret between a RADIUS client and the server (SLB). The shared secret is used to encrypt a password sent between the client and the server. May have up to 128 characters.
RADIUS Server #2	IP address or host name of the secondary RADIUS server. This server can be used as a SecurID proxy.
Server #2 Port	Number of the TCP port on the RADIUS server used for the RADIUS service. If you do not specify an optional port, the SLB branch office manager uses the default RADIUS port (1812).
Server #2 Secret	Text that serves as a shared secret between a RADIUS client and the server (SLB). The shared secret is used to encrypt a password sent between the client and the server. May have up to 128 characters.
Timeout	The number of seconds (1-30) after which the connection attempt times out. The default is 30 seconds.
Use VSA	Select the check box to obtain remote user attributes (group/permissions and port access) from the RADIUS server via the Vendor-Specific Attribute (VSA). For details on the format of the VSA, see User Attributes & Permissions from LDAP Schema or RADIUS VSA on page 205 .
Custom Menu	If custom menus have been created, you can assign a default custom menu to RADIUS users.
Escape Sequence	<p>A single character or a two-character sequence that causes the SLB unit to leave direct (interactive) mode. (To leave listen mode, press any key.)</p> <p>A suggested value is Esc+A (escape key, then uppercase "A" performed quickly but not simultaneously). You would specify this value as <code>\x1bA</code>, which is hexadecimal (<code>\x</code>) character 27 (1B) followed by an A.</p> <p>This setting allows the user to terminate the <code>connect direct</code> command on the command line interface when the endpoint of the command is <code>deviceport</code>, <code>tcp</code>, or <code>udp</code>.</p>
Break Sequence	A series of 1-10 characters users can enter on the command line interface to send a break signal to the external device. A suggested value is Esc+B (escape key, then uppercase "B" performed quickly but not simultaneously). You would specify this value as <code>\x1bB</code> , which is hexadecimal (<code>\x</code>) character 27 (1B) followed by a B .
Enable for Dial-back	Select to grant a user dial-back access. Users with dial-back access can dial into the SLB device and enter their login and password. Once the SLB branch office manager authenticates them, the modem hangs up and dials them back. Disabled by default.

Dial-back Number	The phone number the modem dials back on depends on this setting for the device port. The user is either dialed back on a fixed number, or on a number that is associated with the user's login (specified here).
Data Ports	The ports users are able to monitor and interact with using the <code>connect direct</code> command.
Listen Port	The ports users are able to monitor using the <code>connect listen</code> command.
Clear Port Buffers	The ports whose port buffer users may clear using the <code>set locallog clear</code> command.
Access Outlets	The power outlets users may monitor and configure.

Note: Older RADIUS servers may use **1645** as the default port. Check your RADIUS server configuration.

3. In the **User Rights** section, select the user group to which RADIUS users will belong.

Group	Select the group to which the RADIUS users will belong: <ul style="list-style-type: none"> ◆ Default Users: This group has only the most basic rights. You can specify additional rights for the individual user. ◆ Power Users: This group has the same rights as Default Users plus Networking, Date/Time, Reboot & Shutdown, and Diagnostics & Reports. ◆ Administrators: This group has all possible rights.
--------------	--

4. Select or clear the checkboxes for the following rights:

Full Administrative	Right to add, update, and delete all editable fields.
Networking	Right to enter Network settings.
Services	Right to enable and disable system logging, SSH and Telnet logins, SNMP, and SMTP.
Secure Lantronix Network	Right to view and manage secure Lantronix units (e.g., SLP, Spider and SLB units) on the local subnet.
Date/Time	Right to set the date and time.
Local Users	Right to add or delete local users on the system.
Remote Authentication	Right to assign a remote user to a user group and assign a set of rights to the user.
SSH Keys	Right to set SSH keys for authenticating users.
User Menus	Right to create a custom user menu for the CLI for NIS users.
Web Access	Right to access Web-Manager.
Diagnostics & Reports	Right to obtain diagnostic information and reports about the unit.
Reboot & Shutdown	Right to use the CLI or shut down the SLB unit and then reboot it.
Firmware & Configuration	Right to upgrade the firmware on the unit and save or restore a configuration (all settings). Selecting this option automatically selects Reboot & Shutdown .
Device Port Operations	Right to control device ports.
Device Port Configuration	Right to access to port settings.
USB	Right to enter modem settings for USB devices.
Power Outlets	Right to configure power outlets.

5. Click the **Apply** button.

Note: You must reboot the unit before your changes will take effect.

RADIUS Commands

Go to [RADIUS Commands \(on page 276\)](#) to view CLI commands which correspond to the web page entries described above.

User Attributes & Permissions from LDAP Schema or RADIUS VSA

Remote user attributes (group/permissions and port access) can be obtained from an Active Directory server's schema via the user attribute 'secureLinxSLCPerms', or from a RADIUS server's Vendor-Specific Attribute (see below). This attribute is a set of parameter-value pairs. Each parameter and value is separated by a space, and a space separates each parameter-value pair. Whitespace is not supported in the value strings. The parameters that are supported are:

- ◆ **rights** - User rights. The value string is a comma-separated list of two letter user permissions. Example: "nt,wb,ra".
- ◆ **data** - Data port access. The value string specifies the list of ports the user has 'direct' access to. Example: "2,4-18,U,L".
- ◆ **listen** - Listen port access. The value string specifies the list of ports the user has 'listen' access to.
- ◆ **clear** - Clear port access. The value string specifies the list of port buffers the user has the right to clear.
- ◆ **outlet** - Outlet port access. The value string is the list of SLB outlets the user has rights for.
- ◆ **group** - User group. Valid values for the value string are "default", "power", and "admin".
- ◆ **escseq** - Escape sequence. The value string specifies the user's escape sequence. Use "\x" to specify non-printable characters. For example, "\x1bA" specifies the sequence "ESC-A".
- ◆ **brkseq** - Break sequence. The value string specifies the user's break sequence.
- ◆ **menu** - Custom user menu. The value string specifies the user's custom user menu.
- ◆ **display** - Display custom user menu when a user logs into the CLI. Valid values for the value string are "yes" and "no".
- ◆ **dbnumber** - Dial-back number. The value string specifies the user's dial-back number for modem dial-back connections.
- ◆ **allowdb** - Allow a user to have dial-back access. Valid values for the value string are "yes" and "no".

RADIUS servers will need to be configured to support the Lantronix Vendor-Specific Attribute. For example, on a FreeRADIUS server, the dictionary will need be updated with the Lantronix definition by including the contents below in a file named *dictionary.lantronix*, and including it in the RADIUS server dictionary definitions by adding the appropriate `$INCLUDE` directive to the main dictionary file.

```
# dictionary.lantronix
#
# Lantronix SLB Branch Office Manager
# Provides SLB-specific user attributes
#
VENDOR Lantronix 244
```

```
BEGIN-VENDOR Lantronix  
  
ATTRIBUTE Lantronix-User-Attributes 1 string  
  
END-VENDOR Lantronix
```

Once this is complete, the users file can be updated to include the Lantronix VSA for any user:

```
myuser    Auth-Type := Local, User-Password == "myuser_pwd"  
          Reply-Message = "Hello, %u",  
          Lantronix-User-Attributes = "data 1-4 listen 1-6 clear 1-4  
          group power"
```

Kerberos

Kerberos is a network authentication protocol that provides strong authentication for client/server applications by using secret-key cryptography.

The system administrator can configure the SLB branch office manager to use Kerberos to authenticate users attempting to log in using the Web, Telnet, SSH, or the console port.

Users who are authenticated through Kerberos are granted device port access through the port permissions on this page.

All Kerberos users are members of a group that has predefined user rights associated with it. You can add additional user rights that are not defined by the group.

To configure the SLB unit to use Kerberos to authenticate users:

1. Click the **User Authentication** tab and select the **Kerberos** option. The following page displays.

Figure 11-7 User Authentication > Kerberos

The screenshot shows the Lantronix SLB882/8824 web interface. At the top, there is a navigation bar with tabs for Network, Services, User Authentication, Devices, Maintenance, and Quick Setup. The 'User Authentication' tab is selected, and the 'Kerberos' sub-tab is active. The main content area is titled 'Kerberos' and contains several configuration sections:

- Enable Kerberos:** A checkbox that is currently unchecked.
- Realm:** A text input field.
- KDC:** A text input field.
- KDC IP Address:** A text input field.
- KDC Port:** A text input field with the value '88'.
- Use LDAP:** A checkbox that is currently unchecked. A note below it states: "Note: If LDAP is used for user lookup, please configure the [LDAP settings](#)."
- Custom Menu:** A dropdown menu set to '<none>'. Below it are fields for 'Escape Sequence' (set to '\x1bA') and 'Break Sequence' (set to '\x1bB').
- Enable for Dial-back:** A checkbox that is currently unchecked.
- Dial-back Number:** A text input field.
- Data Ports:** A text input field with the value '1-8,U1,U2'.
- Listen Ports:** A text input field with the value '1-8,U1,U2'.
- Clear Port Buffers:** A text input field with the value '1-8,U1,U2'.
- Access Outlets:** A text input field with the value '1-8'.

Below the Kerberos configuration is the 'User Rights' section. It includes a 'Group' dropdown menu with options for 'Default Users', 'Power Users', and 'Administrators'. A note states: "All Kerberos users are members of a group which has predefined user rights associated with it. Additional rights which are not defined by the group can be added." Below this are several checkboxes for user rights, including 'Full Administrative', 'Networking', 'Services', 'Secure Lantronix Network', 'Date/Time', 'Local Users', 'Remote Authentication', 'SSH Keys', 'User Menus', 'Web Access', 'Diagnostics & Reports', 'Reboot & Shutdown', 'Firmware & Configuration', 'Device Port Operations', 'Device Port Configuration', 'USB', and 'Power Outlets'. An 'Apply' button is located at the bottom of the User Rights section.

2. Enter the following:

Enable Kerberos	Displays selected if you enabled this method on the User Authentication page. If you want to set up this authentication method but not enable it immediately, clear the checkbox. <i>Note: You can enable Kerberos here or on the first User Authentication page. If you enable Kerberos here, it automatically displays at the end of the order of precedence on the User Authentication page.</i>
Realm	Enter the name of the logical network served by a single Kerberos database and a set of Key Distribution Centers. Usually, realm names are all uppercase letters to differentiate the realm from the Internet domain. Realm is similar in concept to an NT domain.
KDC	A key distribution center (KDC) is a server that issues Kerberos tickets. A ticket is a temporary set of electronic credentials that verify the identity of a client for a particular service. Enter the KDC in the fully qualified domain format (FQDN). An example is SLB.local.
KDC IP Address	Enter the IP address of the Key Distribution Center (KDC).
KDC Port	Port on the KDC listening for requests. Enter an integer with a maximum value of 65535. The default is 88 .
Use LDAP	Indicate whether Kerberos should rely on LDAP to look up user IDs and Group IDs. This setting is disabled by default. <i>Note: Make sure to configure LDAP if you select this option.</i>
Custom Menu	If custom menus have been created, you can assign a default custom menu to RADIUS users.
Escape Sequence	A single character or a two-character sequence that causes the SLB unit to leave direct (interactive) mode. (To leave listen mode, press any key.) A suggested value is Esc+A (escape key, then uppercase "A" performed quickly but not simultaneously). You would specify this value as <code>\x1bA</code> , which is hexadecimal (<code>\x</code>) character 27 (1B) followed by an A . This setting allows the user to terminate the <code>connect direct</code> command on the command line interface when the endpoint of the command is <code>deviceport</code> , <code>tcp</code> , or <code>udp</code> .
Break Sequence	A series of 1-10 characters users can enter on the command line interface to send a break signal to the external device. A suggested value is Esc+B (escape key, then uppercase "B" performed quickly but not simultaneously). You would specify this value as <code>\x1bB</code> , which is hexadecimal (<code>\x</code>) character 27 (1B) followed by a B .
Enable for Dial-back	Select to grant a user dial-back access. Users with dial-back access can dial into the SLB branch office manager and enter their login and password. Once the SLB unit authenticates them, the modem hangs up and dials them back. Disabled by default.
Dial-back Number	The phone number the modem dials back on depends on this setting for the device port. The user is either dialed back on a fixed number, or on a number that is associated with the user's login (specified here).
Data Ports	The ports users are able to monitor and interact with using the <code>connect direct</code> command.
Listen Port	The ports users are able to monitor using the <code>connect listen</code> command.
Clear Port Buffers	The ports whose port buffer users may clear using the <code>set locallog clear</code> command.
Access Outlets	The power outlets users may monitor and configure.

3. In the **User Rights** section, select the user group to which Kerberos users will belong.

Group	Select the group to which the Kerberos users will belong: <ul style="list-style-type: none"> ◆ Default Users: This group has only the most basic rights. You can specify additional rights for the individual user. ◆ Power Users: This group has the same rights as Default Users plus Networking, Date/Time, Reboot & Shutdown, and Diagnostics & Reports. ◆ Administrators: This group has all possible rights.
--------------	--

4. Select or clear the checkboxes for the following rights:

Full Administrative	Right to add, update, and delete all editable fields.
Networking	Right to enter Network settings.
Services	Right to enable and disable system logging, SSH and Telnet logins, SNMP, and SMTP.
Secure Lantronix Network	Right to view and manage secure Lantronix units (e.g., SLP, Spider and SLB units) on the local subnet.
Date/Time	Right to set the date and time.
Local Users	Right to add or delete local users on the system.
Remote Authentication	Right to assign a remote user to a user group and assign a set of rights to the user.
SSH Keys	Right to set SSH keys for authenticating users.
User Menus	Right to create a custom user menu for the CLI for Kerberos users.
Web Access	Right to access Web-Manager.
Diagnostics & Reports	Right to obtain diagnostic information and reports about the unit.
Reboot & Shutdown	Right to use the CLI or shut down the SLB devices and then reboot it.
Firmware & Configuration	Right to upgrade the firmware on the unit and save or restore a configuration (all settings). Selecting this option automatically selects Reboot & Shutdown .
Device Port Operations	Right to control device ports.
Device Port Configuration	Right to access to port settings.
USB	Right to enter modem settings for USB devices.
Power Outlets	Right to configure power outlets.

5. Click the **Apply** button.

Note: You must reboot the unit before your changes will take effect.

Kerberos Commands

Go to [Kerberos Commands \(on page 269\)](#) to view CLI commands which correspond to the web page entries described above.

TACACS+

Similar to RADIUS, the main function of TACACS+ is to perform authentication for remote access. The SLB branch office manager supports the TACACS+ protocol (not the older TACACS or XTACACS protocols).

The system administrator can configure the SLB branch office manager to use TACACS+ to authenticate users attempting to log in using the Web, Telnet, SSH, or the console port.

Users who are authenticated through Kerberos are granted device port access through the port permissions on this page.

All TACACS+ users are members of a group that has predefined user rights associated with it. You can add additional user rights that are not defined by the group.

TACACS+ Groups

This section describes how a `priv_lvl` assigned to a TACACS+ user can be mapped to a SLB custom *Groups*, which will set the permissions and port rights for a TACACS+ user when they login to the SLB.

TACACS+ users are typically configured to have a privilege level 0-15, with each level representing a privilege level that is a superset of the next lower value. The privilege level can be assigned to individual users, or to groups that the user is a member of. When the SLB authenticates a TACACS+ user, it will first send an authentication request to the TACACS+ server, and wait for an authentication reply. If the user is successfully authenticated, the SLB will next send an authorization request to the TACACS+ server with the **Service** and optional **Protocol**. The SLB will wait for an authorization response that will indicate if the user was successfully authorized for the requested service and protocol, and also contains a set of attribute-value pairs which define the attributes associated with the TACACS+ user.

The `priv_lvl` or `priv-lvl` is the only attribute sent from the TACACS+ server that the SLB will recognize and utilize. The privilege level number will be used to map to a SLB custom user group by finding a group with a name that ends in the same number as the `priv_lvl`. For example, a SLB group called "admin15" will map to any TACACS+ users with `priv_lvl` equal to 15; a SLB group called "manager8" will map to any TACACS+ users with `priv_lvl` equal to 8, and a SLB group called "readonly0" will map to any TACACS+ users with `priv_lvl` equal to 0. If two SLB groups ending with the same number exist, the SLB will select the first matching group it finds while searching the group list; for consistency it is recommended that only one SLB group exist for each `priv_lvl`.

When a TACACS+ user authenticates to the SLB, the Authentication Log will record any `priv_lvl` attribute-value pair returned by the TACACS+ server:

```
Sep 21 15:44:38 2017 slc431d SLC-SLB/x15login[2839]:
pam_sm_authenticate: server returned attribute `PRIV_LVL=14'
```

Any `priv_lvl` obtained for a TACACS+ user can also be viewed at the CLI with the `show user` command.

To configure the SLB unit to use TACACS+ to authenticate users:

1. Click the **TACACS+** tab and select **TACACS+**. The following page displays.

Figure 11-8 User Authentication > TACACS+

The screenshot shows the LANTRONIX SLB882/8824 configuration interface. At the top, there is a status bar with a host name 'slb2056' and user 'sysadmin'. Below this is a navigation menu with tabs for Network, Services, User Authentication, Devices, Maintenance, and Quick Setup. The 'User Authentication' tab is selected, and the 'TACACS+' sub-tab is active. The main content area is titled 'TACACS+' and contains the following configuration options:

- Enable TACACS+:** A checkbox that is currently unchecked.
- TACACS+ Server #1, #2, #3:** Three text input fields for server addresses.
- Secret:** A text input field for the shared secret.
- Retype Secret:** A text input field for re-entering the secret.
- Encrypt Messages:** A checked checkbox.
- Authentication Service:** Radio buttons for ASCII Login, PPP/PAP (selected), and PPP/CHAP.
- Service:** A text input field containing 'shell'.
- Protocol:** A text input field.
- Custom Menu:** A dropdown menu set to '<none>'. Below it are fields for **Escape Sequence** (set to '\x1bA') and **Break Sequence** (set to '\x1bB').
- Enable for Dial-back:** An unchecked checkbox.
- Dial-back Number:** A text input field.
- Data Ports:** A text input field containing '1-8,U1,U2'.
- Listen Ports:** A text input field containing '1-8,U1,U2'.
- Clear Port Buffers:** A text input field containing '1-8,U1,U2'.
- Access Outlets:** A text input field containing '1-8'.

Below the TACACS+ configuration is the **User Rights** section, which includes:

- Group:** Radio buttons for Default Users (selected), Power Users, and Administrators.
- Full Administrative:** An unchecked checkbox.
- Networking:** An unchecked checkbox.
- Services:** An unchecked checkbox.
- Secure Lantronix Network:** An unchecked checkbox.
- Date/Time:** An unchecked checkbox.
- Local Users:** An unchecked checkbox.
- Remote Authentication:** An unchecked checkbox.
- SSH Keys:** An unchecked checkbox.
- User Menu:** An unchecked checkbox.
- Web Access:** An unchecked checkbox.
- Diagnostics & Reports:** An unchecked checkbox.
- Reboot & Shutdown:** An unchecked checkbox.
- Firmware & Configuration:** An unchecked checkbox.
- Device Port Operations:** An unchecked checkbox.
- Device Port Configuration:** An unchecked checkbox.
- USB:** An unchecked checkbox.
- Power Outlets:** An unchecked checkbox.

An **Apply** button is located at the bottom of the User Rights section. A help icon is visible in the top right corner of the TACACS+ section.

2. Enter the following:

Enable TACACS+	Displays selected if you enabled this method on the User Authentication page. If you want to set up this authentication method but not enable it immediately, clear the checkbox. You can enable TACACS+ here or on the first User Authentication page. If you enable TACACS+ here, it automatically displays at the end of the order of precedence on the User Authentication page.
TACACS+ Servers 1-3	IP address or host name of up to three TACACS+ servers.
Secret/Retype Secret	Shared secret for message encryption between the SLB branch office manager and the TACACS+ server. Enter an alphanumeric secret of up to 127 characters.
Encrypt Messages	Select the checkbox to encrypt messages between the SLB unit and the TACACS+ server. Selected by default.

Authentication Service	The type of service used to pass the authentication tokens (e.g., login and password) between the SLB and the TACACS+ server. Options are: ASCII Login (login and password are transmitted in clear, unencrypted text), PPP/PAP (login and password are transmitted in clear, unencrypted text via a PAP protocol packet), and PPP/CHAP (the TACACS+ server sends a challenge that consists of a session ID and an arbitrary challenge string, and the user name and password are encrypted before they are sent back to the server). PPP/PAP is the default.
Service	The service to use when sending a TACACS+ authorization message to the server to obtain an authenticated user's <code>priv_lvl</code> . The <code>priv_lvl</code> is used to assign a SLB custom group to the authenticated user for permissions and port rights (see TACACS+ Groups). Suggested values are "slip", "ppp", "arap", "shell", "ttydaemon", "connection", "system" and "firewall". The default is "shell".
Protocol	The optional protocol associated with the Service, which is included in the TACACS+ authorization message sent to the server to obtain an authenticated user's <code>priv_lvl</code> . The <code>priv_lvl</code> is used to assign a SLB custom group to the authenticated user for permissions and port rights (see TACACS+ Groups). Suggested values are "lcp", "ip", "ipx", "atalk", "vines", "lat", "xremote", "tn3270", "telnet", "rlogin", "pad", "vpdn", "ftp", "http", "deccp", "osicp" and "unknown".
Custom Menu	If custom menus have been created (see Custom Menus), you can assign a default custom menu to TACACS+ users.
Escape Sequence	A single character or a two-character sequence that causes the SLB unit to leave direct (interactive) mode. (To leave listen mode, press any key.) A suggested value is Esc+A (escape key, then uppercase "A" performed quickly but not simultaneously). You would specify this value as <code>\x1bA</code> , which is hexadecimal (<code>\x</code>) character 27 (1B) followed by an A . This setting allows the user to terminate the <code>connect direct</code> command on the command line interface when the endpoint of the command is <code>deviceport</code> , <code>tcp</code> , or <code>udp</code> .
Break Sequence	A series of 1-10 characters users can enter on the command line interface to send a break signal to the external device. A suggested value is Esc+B (escape key, then uppercase "B" performed quickly but not simultaneously). You would specify this value as <code>\x1bB</code> , which is hexadecimal (<code>\x</code>) character 27 (1B) followed by a B . See Custom Menus for notes on key sequence precedence and behavior.
Enable for Dial-back	Select to grant a user dial-back access. Users with dial-back access can dial into the SLB device and enter their login and password. Once the SLB branch office manager authenticates them, the modem hangs up and dials them back. Disabled by default.
Dial-back Number	The phone number the modem dials back on depends on this setting for the device port. The user is either dialed back on a fixed number, or on a number that is associated with the user's login (specified here).
Data Ports	The ports users are able to monitor and interact with using the <code>connect direct</code> command.
Listen Ports	The ports users are able to monitor using the <code>connect listen</code> command.
Clear Port Buffers	The ports whose port buffer users may clear using the <code>set locallog clear</code> command.
Access Outlets	The power outlets users may monitor and configure.

3. In the **User Rights** section, select the user group to which TACACS+ users will belong.

Group	Select the group to which the TACACS+ users will belong: <ul style="list-style-type: none"> ◆ Default Users: This group has only the most basic rights. You can specify additional rights for the individual user. ◆ Power Users: This group has the same rights as Default Users plus Networking, Date/Time, Reboot & Shutdown, and Diagnostics & Reports. ◆ Administrators: This group has all possible rights.
--------------	---

4. Select or clear the checkboxes for the following rights:

Full Administrative	Right to add, update, and delete all editable fields.
Networking	Right to enter Network settings.
Services	Right to enable and disable system logging, SSH and Telnet logins, SNMP, and SMTP.
Secure Lantronix Network	Right to view and manage secure Lantronix units (e.g., SLP, Spider and SLB units) on the local subnet.
Date/Time	Right to set the date and time.
Local Users	Right to add or delete local users on the system.
Remote Authentication	Right to assign a remote user to a user group and assign a set of rights to the user.
SSH Keys	Right to set SSH keys for authenticating users.
User Menus	Right to create a custom user menu for the CLI for TACACS+ users.
Web Access	Right to access Web-Manager.
Diagnostics & Reports	Right to obtain diagnostic information and reports about the unit.
Reboot & Shutdown	Right to use the CLI or shut down the SLB unit and then reboot it.
Firmware & Configuration	Right to upgrade the firmware on the unit and save or restore a configuration (all settings). Selecting this option automatically selects Reboot & Shutdown.
Device Port Operations	Right to control device ports.
Device Port Configuration	Right to access to port settings.
USB	Right to enter modem settings for USB devices.
Power Outlets	Right to configure power outlets.

5. Click the **Apply** button.

Note: You must reboot the unit before your changes will take effect.

TACACS+ Commands

Go to [TACACS+ Commands \(on page 277\)](#) to view CLI commands which correspond to the web page entries described above.

Groups

The SLB branch office manager has 3 pre-defined groups: Administrators, Power Users, and Default Users. Custom groups can also be created; each custom group is a set of user attributes and permissions. Local Users and Remote Users defined on the SLB unit can be assigned to one of the pre-defined groups or a custom group. When a user authenticates, if they belong to custom group, they will be granted the custom group attributes and permissions, rather than their individual attributes and permissions. The SLB device supports querying a LDAP server for groups that a LDAP user is a member of; if any of the LDAP group names match a (Custom Group Name), the LDAP user will be granted the rights of the custom group.

A custom group cannot be given the name of one of the pre-defined groups: "Admin", "Power" or "Default" (or any version of these names where the case of the letters is different) since these names are used for the SLB pre-defined groups. Any LDAP group that matches one of these pre-defined group names will be ignored and not used to assign rights to a user.

To configure Groups in the SLB:

1. From the main menu, select **User Authentication - Groups**. The following page displays.

Note: If the fields in the lower part of the page have been populated by viewing another group, the fields can be cleared by selecting the Reset Group button.

Figure 11-9 User Authentication > Group

The screenshot shows the Lantronix SLB882/8824 web interface. The top navigation bar includes 'Network', 'Services', 'User Authentication', 'Devices', 'Maintenance', and 'Quick Setup'. The 'User Authentication' section is active, showing 'Auth Methods', 'Local/Remote Users', 'NIS', 'LDAP', 'RADIUS', 'Kerberos', 'TACACS+', 'Groups', 'SSH Keys', and 'Custom Menus'. The 'Groups' page is displayed, featuring a table with columns: Id, Name, Permissions, Esc Seq, Brk Seq, Custom Menu, DB, Listen, Data, Clear, and Outlet. Below the table is a configuration form for a group with Group Id: 0. The form includes fields for Group Name, Listen Ports (1-8,U1,U2), Data Ports (1-8,U1,U2), Clear Port Buffers (1-8,U1,U2), and Access Outlets (1-8). It also has checkboxes for 'Enable for Dial-back', 'Local Users', 'Remote Authentication', 'SSH Keys', 'User Menus', 'Web Access', 'Diagnostics & Reports', 'Reboot & Shutdown', 'Firmware & Configuration', 'Device Port Operations', 'Device Port Configuration', 'USB', and 'Power Outlets'. A 'Custom Menu' dropdown is set to '<none>'. Buttons for 'Reset Group', 'Add Group', and 'Edit Group' are also visible.

2. Enter the following:

Group Name	Enter a name for the group.
Listen Ports	The ports users are able to monitor using the <code>connect listen</code> command.
Data Ports	The ports users are able to monitor and interact with using the <code>connect direct</code> command. Enter the port numbers or the range of port numbers (for example, 1, 5, 8, 10-15). U1 denotes the USB port on the front of the SLB unit. For SLB models with an internal modem, U2 denotes the internal modem.
Clear Port Buffers	The ports whose port buffer users may clear using the <code>set locallog clear</code> command.
Access Outlets	The power outlets users may monitor and configure. (SLB only)
Enable for Dial-back	Select to grant a user. Users with dial-back access can dial into the SLB unit and enter their login and password. Once the SLB device authenticates them, the modem hangs up and dials them back. Disabled by default.
Dial-back Number	The phone number the modem dials back on depends on this setting for the device port. The user is either on a fixed number, or on a number that is associated with the user's login (specified here).

Escape Sequence	<p>A single character or a two-character sequence that causes the SLB branch office manager to leave direct (interactive) mode. (To leave listen mode, press any key.)</p> <p>A suggested value is Esc+A (escape key, then uppercase "A" performed quickly but not simultaneously). You would specify this value as \x1bA, which is hexadecimal (\x) character 27 (1B) followed by an A.</p> <p>This setting allows the user to terminate the <code>connect direct</code> command on the command line interface when the endpoint of the command is <code>deviceport</code>, <code>tcp</code>, or <code>udp</code>.</p>
Break Sequence	<p>A series of one to ten characters users can enter on the command line interface to send a break signal to the external device. A suggested value is Esc+B (escape key, then uppercase "B" performed quickly but not simultaneously). You would specify this value as \x1bB, which is hexadecimal (\x) character 27 (1B) followed by a B.</p>
Custom Menu	<p>If custom menus have been created you can assign a default custom menu to the group. See Custom Menus for more information.</p>
Display Menu at Login	<p>Check the checkbox to display the menu at login.</p>

3. Select or clear the checkboxes for the following rights:

Full Administrative	Right to add, update, and delete all editable fields.
Networking	Right to enter network settings.
Services	Right to enable and disable system logging, SSH and Telnet logins, SNMP, and SMTP.
Secure Lantronix Network	Right to view and manage secure Lantronix units (e.g., SLP, Spider, and SLB units) on the local subnet.
Date/Time	Right to set the date and time.
Local Users	Right to add or delete local users on the system.
Remote Authentication	Right to assign a remote user to a user group and assign a set of rights to the user.
SSH Keys	Right to set SSH keys for authenticating users.
User Menus	Right to create or edit a custom user menu for the CLI.
Web Access	Right to access Web-Manager.
Diagnostics & Reports	Right to obtain diagnostic information and reports about the unit.
Reboot & Shutdown	Right to use the CLI or shut down the SLB unit and then reboot it.
Firmware & Configuration	Right to upgrade the firmware on the unit and save or restore a configuration (all settings).
Device Port Operations	Right to enter control device ports.
Device Port Configuration	Right to enter device port settings.
USB	Right to enter modem settings for USB devices.
Power Outlets	Right to view and enter settings for power outlets (SLB unit only).

4. Click the **Add Group** button.

To view or update a group:

1. In the **Groups** table, select the group and click the **View Group** button. The group attributes and permissions will be displayed in the lower section of the page.
2. Modify the group attributes and permissions and click the **Edit Group** button.

To delete a group:

1. Select the group in the **Groups** table.
2. Click the **Delete Group** button.

SSH Keys

The SLB branch office manager can import and export SSH keys to facilitate shared key authentication for all incoming and outgoing SSH connections. By using a public/private key pair, a user can access multiple hosts with a single passphrase, or, if a passphrase is not used, a user can access multiple hosts without entering a password. In either case, the authentication is protected against security attacks because both the public key and the private key are required to authenticate. For both imported and exported SSH keys, the SLB unit supports both RSA and DSA keys, and can import and export keys in OpenSSH and SECSH formats. Imported and exported keys are saved with the SLB configuration, and the administrator has the option of retaining the SSH keys during a reset to factory defaults.

The SLB device can also update the SSH RSA1, RSA and DSA host keys that the SSH server uses with site-specific host keys or reset them to the default values.

Imported Keys

Imported SSH keys must be associated with an SLB local user. The key can be generated on host "MyHost" for user "MyUser," and when the key is imported into the SLB, it must be associated with either "MyUser" (if "MyUser" is an existing SLB local user) or an alternate SLB local user. The public key file can be imported via SCP or FTP; once imported, you can view or delete the public key. Any SSH connection into the SLB branch office manager from the designated host/user combination uses the SSH key for authentication.

Exported Keys

The SLB unit can generate SSH keys for SSH connections out of the SLB device for any SLB user. The SLB branch office manager retains both the private and public key on the SLB unit, and makes the public key available for export via SCP, FTP, or copy and paste. The name of the key is used to generate the name of the public key file that is exported (for example, <keyname>.pub), and the exported keys are organized by user and key name. Once a key is generated and exported, you can delete the key or view the public portion. Any SSH connection out of the SLB branch office manager for the designated host/user combination uses the SSH key for authentication.

To configure the SLB unit to use SSH keys to authenticate users:

1. From the main menu, select **User Authentication - SSH Keys**. The following page displays.

Figure 11-10 User Authentication > SSH Keys

LANTRONIX[®] SLB882/8824

Logout Host: slb02fa User: sysadmin

Select port for: Configuration WebSSH (DP only) Connected Device (DP only)

Network Services **User Authentication** Devices Maintenance Quick Setup

Auth Methods Local/Remote Users NIS LDAP RADIUS Kerberos TACACS+ Groups SSH Keys Custom Menus

SSH Keys Help ?

[SSH Server/Host Keys](#)

Imported Keys (SSH In)

Host & User Associated with Key
(not required if host and SLB Local User login are declared in imported key file; ignored if file contains multiple keys)

Host:
 User:

Host & Login for Import

Import via: SCP [Unread File](#)

Filename:
 Host:
 Path:
 Login:
 Password:
 Retype Password:

Imported SSH Keys		
View	Delete	
User	Host	Type

Exported Keys (SSH Out)

Export: New Key for User All Previously Created Keys

User:
 Key Name:
 Key Type: RSA DSA
 Number of Bits: 1024
 Passphrase:
 Retype Passphrase:
 SECSH Format:
 Public Key Filename:

Host & Login for Export

Export via: Copy/Paste

Host:
 Path:
 Login:
 Password:
 Retype Password:

Exported SSH Keys		
View	Download	Delete
User	Key Name	Type

2. Enter the following:

Imported Keys (SSH In)

Host & User Associated with Key

These entries are required in the following cases:

- ◆ The imported key file does not contain the host that the user will be making an SSH connection from, or
- ◆ The SLB local user login for the connection is different from the user name the key was generated from or is not included in the imported key file.

If either of these conditions is true, or the imported file is in SECSH format, you must specify the user and host. The following is an example of a public key file that includes the user and host:

```
ssh-rsa AAAAB3NzaC1yc2EAAAABIwAAAEEApUHCX9EWsHt+jmUGXa1YC3us
ABYxIXUhSU1N+NU9HNaUADUFfd8LYz8/gUnUSH4Ksm8GRT7/8/Sn9jCVfGPh
UQ== asallaway@winserver
```

Host	Host name or IP address from which the SSH connections to the SLB branch office manager will be made.
User	The User ID of the user being given secure access to the SLB unit.

Host & Login for Import

Import via	Select SCP or FTP as the method for importing the SSH keys. SCP is the default.
Filename	Name of the public key file (for example, mykey.pub). May contain multiple keys.
Host	IP address of the remote server from which to SCP or FTP the public key file.
Path	Optional pathname to the public key file.
Login	User ID to use to SCP or FTP the file.
Password / Retype Password	Password to use to SCP or FTP the file.

Exported Keys (SSH Out)

Export	Enables you to export created public keys. Select one of the following: New Key for User: Enables you to create a new key for a user and export the public key in a file. All Previously Created Keys: Does not create any keys, but exports all previously created public keys in one file.
User	User ID of the person given secure access to the remote server.
Key Name	Name of the key. This will generate the public key filename (e.g., <keyname>.pub).
Key Type	Select either the RSA or the DSA encryption standard. RSA is the default.
Number of Bits	Select the number of bits in the key (512 or 1024). The default is 512 .
Passphrase / Retype Passphrase	Optionally, enter a passphrase associated with the key. The passphrase may have up to 50 characters. The passphrase is an optional password that can be associated with an SSH key. It is unique to each user and to each key.
SECSH Format	Indicate whether the keys will be exported in SECSH format (by default the key is exported in OpenSSH format).
Public Key Filename	Filename of the public host key.

Host and Login for Export

Export via	Select the method (SCP , FTP , HTTPS or Copy/Paste) of exporting the key to the remote server. Copy/Paste , the default, requires no other parameters for export.
Host	IP address of the remote server to which the SLB unit will SCP or FTP the public key file.
Path	Optional path of the file on the host to SCP or FTP the public key too.
Login	User ID to use to SCP or FTP the public key file.
Password / Retype Password	Password to use to SCP or FTP the public key file.

To view or delete a key:

1. Select the key from the appropriate table. The **View** and **Delete** buttons become active.
2. To view the key, click the **View** button. A pop-up page displays the key.

```
Imported key for sysadmin@DaveSLM:
ssh-rsa AAAAB3NzaC1yc2EAAAABIwAAAIEAxGxPGY9HsG9VqroDo98B89Cf
haqB6jG//0tTMKkb3zrpPu0HHAXaiVXHAvv7lAte31VTpoXdLAXN0uCvuJLf
aL/LvvGmoEWBuBSu505lQHfL70ijxZWOEVTJGFqUQTSq8Ls3/v3lkUJEX5ln
2AlQx0F40I5wNEC0+m3d5QE+FKc= sysadmin@DaveSLM
```

3. To delete the key, click the **Delete** button.

To view, reset, or import SSH RSA1, RSA, And DSA host keys:

1. On the **User Authentication - SSH Keys** page, click the **SSH Server/Host Keys** link at the top right. The following page displays the current host keys. In the example below, the current keys are the defaults.

Figure 11-11 Current Host Keys

LANTRONIX SLB882/8824

Host: slb02fa
User: sysadmin

Select port for: Configuration WebSSH (DP only) Connected Device (DP only)

Network Services **User Authentication** Devices Maintenance Quick Setup

Auth Methods Local/Remote Users NIS LDAP RADIUS Kerberos TACACS+ Groups SSH Keys Custom Menus

SSH Server/Host Keys

Current Host RSA1 Public Key (Default Key)

```
Fingerprint:
2048 4a:b3:bd:a3:04:91:89:a9:32:d9:e8:a4:44:17:44:71 ssh_host_key.pub
```

Current Host RSA Public Key (Default Key)

```
ssh-rsa AAAAB3NzaC1yc2EAAAADAQABAAQCCmXkLX7GT1nw5DzUzZsmPsV92xi2WGrEXEeDJVGVMPrFjG3xVADB7dB3XKXosb01uM6MX4aj4eMz569L+LFT6j5eIG8/OyqesvL3Y02127Exq3sEY9dEkDMw6k0jNmWp02imx0wj1082c1ts4ORCDrrNWQ1nhcsOMZpSVOE/AAj/EB+0Fex4Z5FXKvUSHCKLU4aqowbtrln9BHd0fzTb+wbW34bFIqG0AwNyLYQyo2s/22Kv0e5Nq6ohpLpaN202W8YdZIQ%ayThU8eTN3dInxzD300SiVjWakOZuZHVZwUvtrR3qSnszHXQRon0uyUl,kWxm0PEbUUE9Nj056agdJR5_root@slb02fa

Fingerprint:
2048 83:ab:80:fe:c0:73:c8:52:96:21:64:da:44:77:de:d7 ssh_host_rsa_key.pub
```

Current Host DSA Public Key (Default Key)

```
ssh-dss AAAAB3NzaC1kc3MAAACBAKackpXmCbOvv92PrPUZBdt7YmnZc6Tkh4JRqkq+y1fJUTwn6ZnRHPVXlpo8Kc/KiYkqD0qUbZpylC+HXZJR2D31+8GpznYsdzqXtw0uV2Q/7iU1xrJQ6JEbC3eAmzEwks2eq+OB4p3bp8bfcYf8Nj3IQN4kDnoB50xV18300dpAAAAFQCYyh1xD4tpcez8j9+/7BKSc537wwAAAI8BbnR9M01Ak5Y9rUKCFeramJ2i2QWB IuL0pqaPrmh0kMcVGF5HQC7s4bQCY7MHeRw8OXXeZ8qOHQdR/71kNbs7+er5bY+cyTE5gArKXp3yU+68DTzYBoVoE/pl1yrZBNbpSLZfwPD1snJqwkKhjyD8WUpcd4g/FnhHrTMNZUF6QAAAI8L0sbKhzm0Tx+kMGLty+VJefhI4/24fmZSxByGm6LYeSzm2KwHPEFILLvLPqbnYg bvsFptsYVS0118f89Q/F9PGN9nkM/orK0yNqtjcuLCDrrMKAEXQ+CLsJmLB0eZqCNIBFCYYBCWPy1Am+R2ol5k9REAdIah7YBdLPvDew= root@ (none)

Fingerprint:
1024 72:5b:3a:16:8e:f9:bf:e7:21:b2:ef:5a:e0:67:df:6f ssh_host_dsa_key.pub
```

Reset to Default Host Key: All Keys RSA1 RSA DSA

Note: changing a host key requires a reboot for the update to take effect.

Import Host Key:

Type: **RSA1**

Import via: **SCP**

Public Key Filename:

Private Key Filename:

Host:

Path:

Login:

Password:

Retype Password:

[Back to SSH Keys](#)

2. View or enter the following:

Reset to Default Host Key	Select the All Keys checkbox to reset all default key(s), or select one or more checkboxes to reset defaults for RSA1 , RSA , or DSA keys. All checkboxes are unselected by default.
Import Host Key	To import a site-specific host key, select the checkbox. Unselected by default.
Type	From the drop-down list, select the type of host key to import.
Import via	From the drop-down list, select the method of importing the host key (SCP or SFTP). The default is SCP .
Public Key Filename	Filename of the public host key.

Private Key Filename	Filename of the private host key.
Host	Host name or IPaddress of the host from which to import the key.
Path	Path of the directory where the host key will be stored.
Login	User ID to use to SCP or SFTP the file.
Password / Retype Password	Password to use to SCP or SFTP the file.

3. Click the **Apply** button.
4. Repeat steps 2-3 for each key you want to import.
5. To return to the SSH Keys page, click the **Back to SSH Keys** link.

SSH Key Commands

Go to [SSH Key Commands \(on page 325\)](#) to view CLI commands which correspond to the web page entries described above.

Custom Menus

Users can have custom user menus as their command line interface, rather than the standard CLI command set. Each custom user menu can contain up to 50 commands ('logout' is always the last command). Instead of typing each command, the user enters the number associated with the command. Each command can also have a nickname associated with it, which can be displayed in the menu instead of the command. The commands `showmenu <Menu Name>` and `returnmenu` can be entered to display another menu from a menu, or to return to the prior menu. The command `returncli` can be used to break out of a menu and return to the regular CLI.

To add a custom menu:

1. Click the **User Authentication** tab and select the **Custom Menus** option. The Custom Menus page displays:

Figure 11-12 User Authentication > Custom Menus

The screenshot shows the LANTRONIX SLB882/8824 web interface. At the top, there's a navigation bar with tabs for Network, Services, User Authentication (selected), Devices, Maintenance, and Quick Setup. Under 'User Authentication', there are sub-tabs for Auth Methods, Local/Remote Users, NIS, LDAP, RADIUS, Kerberos, TACACS+, Groups, SSH Keys, and Custom Menu (selected). The 'Custom Menus' page has a 'Custom Menu' section with a 'Name' field and buttons for 'View Custom Menu', 'Delete Custom Menu', and 'Copy Custom Menu'. Below this is a form with fields for 'Menu Name', 'Title', 'Nicknames' (checked), and 'Redisplay Menu' (unchecked). There are buttons for 'Clear Custom Menu', 'Add Custom Menu', and 'Edit Custom Menu'. A 'Commands/Nicknames List' section contains a list with 'logout(logout)' and navigation arrows. At the bottom, there are buttons for 'Delete Command & Nickname', 'Clear Command & Nickname', and 'Unselect Command & Nickname'.

2. In the lower section of the page, enter the following:

Note: To clear fields in the lower part of the page, click the **Clear Custom Menu** button.

Menu Name	Enter a name for the custom menu.
------------------	-----------------------------------

Title	Enter an optional title which will be displayed about the menu at the CLI.
Nicknames	Select to enable nicknames to be displayed in the menu instead of the commands. If the custom menu will have nicknames, this should also be selected prior to entering the commands in the web page, as this will facilitate entry of the nicknames.
Redisplay Menu	Select to redisplay the custom menu each time before the CLI prompt is displayed.





3. You have the following options:

- ◆ To save the custom menu without any more commands than the default **logout** command, click the **Add Custom Menu** button.
- ◆ To add menu commands, select the **QuickEdit Mode** box. This will move the cursor from **Command** to **Nickname** and back to **Command** (if **Nicknames** is selected), or keep the cursor on **Command** (if **Nicknames** is not selected). Commands (and the optional nicknames) are added to the **Menu Commands/Nicknames** list when carriage return is entered at the **Command** field (if **Nicknames** is not selected) or the **Nickname** field (if **Nicknames** is selected). Most browsers have a "Select All" keystroke (such as Control-A) which allow you to select all of the text in a field; this can be used in conjunction with the Delete key to clear the contents of a field before entering a new command or nickname. The **Clear Command & Nickname** button can also be used to delete the contents of the Command and Nickname fields.

Commands can also be added to the list when **QuickEdit Mode** is not selected. Enter the command and the optional nickname and click the **right**  **arrow**. The command will be added before the logout command (if a command/nickname is not selected in the list) or will replace the currently selected command/nickname in the list. The **Unselect Command & Nickname** button can be used to unselect the currently selected command/nickname in the list.

4. To add more commands to the custom menu, repeat step 3.

5. You also have the following options:

- ◆ To edit a command/nickname in the custom menu, select the command in the **Commands/Nicknames List** box and select the **left**  **arrow** button. Change the command and/or the nickname, and with the same command still selected in the list, select the **right**  **arrow** button.
- ◆ To remove a command/nickname from the custom menu, select the command in the **Commands/Nicknames List** box and select the **Delete Command & Nickname** button.
- ◆ To move a command higher up in the menu (the commands are shown in the order they will be presented in the custom menu, with command #1 listed first), select the command in the **Commands/Nicknames List** box and click the **up**  **arrow**.
- ◆ To move a command further down in the menu, select the menu in the **Commands/Nicknames List** and click the **down**  **arrow**.

6. Click the **Add Custom Menu** button.

To view or update a custom menu:

1. In the **Custom Menus** table, select the custom menu and click the **View Custom Menu** button. The custom menu attributes appear in the lower part of the page.
2. Update the menu attributes following the instructions for adding a menu above.

3. Click the **Edit Custom Menu** button.

To delete a custom menu:

1. Select the custom menu in the **Custom Menus** table.
2. Click the **Delete Custom Menu** button.

To create a new custom menu from an existing custom menu:

1. Select the custom menu in the **Custom Menus** table.
2. Enter a name for the new menu in the **New Menu Name** field.
3. Click the **Copy Custom Menu** button.

Custom User Menu Commands

Go to [Custom User Menu Commands \(on page 287\)](#) to view CLI commands which correspond to the web page entries described above.

12: Maintenance

The system administrator performs maintenance activities and operates the SLB branch office manager using the options for the Maintenance tab and additional commands on the command line interface.

SLB Maintenance

The [Maintenance > Firmware & Configurations](#) page allows the system administrator to:

- ◆ Configure the FTP, SFTP, or TFTP server that will be used to provide firmware updates and save/restore configurations. (TFTP is only used for firmware updates and configurations restored via DHCP/TFTP Zero Touch Provisioning.)
- ◆ Set up the location or method that will be used to save or restore configurations (default, FTP, SFTP, NFS, CIFS, or USB). Update the version of the firmware running on the SLB.
- ◆ Save a snapshot of all settings on the SLB unit (save a configuration).
- ◆ Restore the configuration, either to a previously saved configuration, or to the factory defaults.
- ◆ For dual boot SLB units, view the firmware version on each boot bank, select the bank to boot from, and copy the contents of one boot bank to the other.
- ◆ View the firmware version on each boot bank, select the bank to boot from, and copy the contents of one boot bank to the other.

To configure settings:

1. Click the **Maintenance** tab. The [Maintenance > Firmware & Configurations](#) page displays.

Figure 12-1 Maintenance > Firmware & Configurations

LANTRONIX

SLB882/8824

LCD

U1

U2

E1

E2

1

2

3

4

5

6

7

8

P1

P2

P3

P4

P5

P6

P7

P8

A

B

Logout

Host: **slb2056**
 User: **sysadmin**

Select port for Configuration WebSSH (DP only) Connected Device (DP only)

Network

Services

User Authentication

Devices

Maintenance

Quick Setup

[Home](#) [?](#) [Refresh](#) [Print](#)

Firmware/Config

System Log

Audit Log

Email Log

Diagnostics

Status/Reports

Events

LCD/Keypad

Banners

Firmware & Configurations

Help?

General

Reboot:

Shutdown:

Internal Temperature

Current: **39 °C / 102 °F**

Low: °C / 32 °F

High: °C / 122 °F

Calibrate Offset: °C / 0 °F

Site Information

Data Center Rack Row:

Data Center Rack Cluster:

Data Center Rack:

Site Tag:

Note: Temperatures can be entered in either Celsius or Fahrenheit; to indicate a temperature is Fahrenheit, append the degrees with an 'F', eg "75F".

SLB Firmware

Current Version: 6.5.0.0RC19

Update Firmware: [Firmware Update Log >](#)

Firmware Filename:

Key:

Load Firmware via: **HTTPS**

Note: Firmware files stored on USB and NFS can be managed by clicking the Manage link below.

Load Firmware Via Options

HTTPS: [Upload File >](#)

NFS Mounted Dir:

USB Port: Port U1

FTP/SFTP/TFTP Server:

Path:

Login:

Password:

Retype Password:

Boot Banks and Bootloader Settings

Bank 1: 6.5.0.0RC19 (current)

Bank 2: 6.5.0.0RC18

Next Boot Bank: 1

Switch to Bank 2:

Copy configuration from Bank 1 to Bank 2 during firmware update:

Copy contents of Bank 1 to Bank 2:

High Resolution Timers: Requires reboot to take effect.

Configuration Management

No Save/Restore

Save Configuration Tarball Format

Restore Factory Defaults

Restore Saved Configuration

Save with Config or Preserve with Restore:

SSH Keys SSL Certificate

Scripts

Preserve Configuration after Restore:

Networking Local Users

Date/Time Device Ports

Services USB

Remote Auth Power Outlets

Configuration Name to Save To or Restore From:

Location for Save, Restore or [Manage >](#)

Local Disk Saved Configurations:

FTP Server Use: FTP SFTP

NFS Mounted Directory:

CIFS Share Saved Configurations:

USB Use: Port U1

HTTPS Saved Configurations:

[Upload File for Restore >](#) File will be uploaded to Local Disk.

Apply

2. Enter the following:

Reboot	Select this option to reboot the SLB branch office manager immediately. The default is No . <i>Note:</i> The front panel LCD displays the "Rebooting the SLB" message, and the normal boot sequence occurs.
Shutdown	Check this option to shut down the SLB. The default is Unchecked .

Internal Temperature

Current	Displays current temperature.
Low (°C)	Sets the acceptable minimum for the internal temperature of the SLB unit. If the temperature of the SLB device changes to be outside of this range, the SLB branch office manager will issue an SNMP trap.
High (°C)	Sets the acceptable maximum for the internal temperature of the SLB unit. If the temperature of the SLB branch office manager changes to be outside of this range, the SLB device will issue an SNMP trap.
Calibrate Offset (°C)	An offset for calibrating the internal temperature of the SLB unit. The offset will be applied one hour after setting the calibration value. Zeroing the offset will take effect immediately and will cancel any current and/or pending calibration.

Site Information

Data Center Rack Row	Set these fields to define the rack row the SLB unit is located within a large data center. The default for these fields is 1.
Data Center Rack Cluster	Set these fields to define the rack cluster the SLB device is located within a large data center. The default for these fields is 1.
Data Center Rack	Set these fields to define the rack the SLB unit is located within a large data center. The default for these fields is 1.
Site Tag	Tag or description used to identify the location or some other attribute of the SLB

SLB Firmware

Current Version	Displays the current firmware version.
Update Firmware	<ul style="list-style-type: none"> ◆ To update the SLB firmware, select the checkbox. If you select this option, the SLB branch office manager reboots after you apply the update. The first time boot for each bank may take up to 5 minutes. Subsequent boot times will be approximately 2 minutes. ◆ To view a log of all prior firmware updates, click the Firmware Update Log link. <p><i>Note:</i> For dual boot SLB units, the non-active boot bank is updated during the firmware update, without requiring a reboot. The configuration on the current boot bank may optionally be copied to the non-active boot bank during the firmware update. For both single boot and dual boot SLB units, prior to firmware update, the current configuration is saved to the Local Disk location with the name "before_MMDDYY_HHMM".</p>
Firmware Filename	The name of the firmware update file downloaded from the Lantronix web site.
Key	A key for validating the firmware file. The key is provided with the firmware file (32 hex characters).

Load Firmware via	From the drop-down list, select the method of loading the firmware. Options are FTP , TFTP , HTTPS , NFS , USB , and SFTP (Secure FTP) . TFTP is the default. If you select HTTPS , the Upload File link becomes active. Select the link to open a popup window that allows you to browse to a firmware update file to upload.
--------------------------	--

Boot Banks

Note: The first time boot for each bank may take up to 5 minutes. Subsequent boot times will be approximately 2 minutes.

Bank 1	Displays the version of SLB firmware in bank 1. Note: The word "current" displays next to the bank from which the SLB branch office manager booted.
Bank 2	Displays the version of SLB firmware in bank 2.
Next Boot Bank	Displays the current setting for bank to boot from at next reboot.
Switch to Bank 2	If desired, select the alternate bank to boot from at next reboot.
Copy configuration from Bank 1 to Bank 3 during firmware update	If checked, will copy the configuration from the current bank to the bank being updated. The two numbers are automatically generated so that the first number is the current bank.
Copy contents of Bank 1 to Bank 2	If checked, enables you to copy the current boot bank to the alternate boot bank. This process takes a few minutes to complete.
High Resolution Timers	Enables or disables timers with a high degree of accuracy. High resolution timers are required for Performance Monitoring (on page 74) , but may affect SLC performance if they are enabled. Off by default. Changing this value requires a reboot for the change to take effect.

Load Firmware Via Options

HTTPS	Click the Upload File link to browse to the file to update the SLB firmware.
NFS Mounted Dir	Select the NFS mounted directory from the drop-down menu.
USB Port	Click to select USB port.
FTP/SFTP/TFTP Server	The IP address or host name of the server used for obtaining updates and saving or restoring configurations. May have up to 64 alphanumeric characters; may include hyphens and underscores.
Path	The default path on the server for obtaining firmware update files and getting and putting configuration save files.
Login	The userid for accessing the FTP server. May be blank.
Password / Retype Password	The FTP user password.

Configuration Management

Configuration Management	<p>From the option list, select one of the following:</p> <ul style="list-style-type: none"> ◆ No Save/Restore: Does not save or restore a configuration. ◆ Restore Factory Defaults: Restores factory defaults. If you select this option, the SLB unit reboots after you apply the update. Select the SSH Keys checkbox to save any imported or exported SSH keys. Select the SSL Certificate checkbox to save an imported certificate. Select the Scripts checkbox to save any interface or batch scripts. Disabled by default. ◆ Restore Saved Configuration: Returns the SLB settings to a previously saved configuration. If you select this option, the SLB reboots after you apply the update. ◆ Save Configuration: Saves all settings to file, which can be backed up to a location that is not on the SLB. If Tarball Format is checked, the configuration will be saved in the old (insecure) compressed tar file format, instead of the password protected zip file format. The Tarball Format is only available for saving a configuration via HTTPS.
Save with Config or Preserve with Restore	<ul style="list-style-type: none"> ◆ Select the SSH Keys checkbox to save any imported or exported SSH keys. ◆ Select the SSL Certificate checkbox to save an imported certificate. ◆ Select the Scripts checkbox to save any interface or batch scripts. Disabled by default.
Preserve Configuration after Restore	<p>Allows the user to keep a subset of the current configuration after restoring a configuration or resetting to factory defaults.</p> <p>Select the checkbox for each part of the current configuration you want to keep, for example, Networking, Services, or Device Ports.</p>
Configuration Name to Save To or Restore From	<p>If you selected to save or restore a configuration, enter a name for the configuration file (up to 12 characters).</p>
Location for Save, Restore, or Manage	<p>If you selected to save or restore a configuration, select one of the following options:</p> <ul style="list-style-type: none"> ◆ Local Disk – Saved Configurations: If restoring, select a saved configuration from the drop-down list. ◆ FTP Server: The FTP server specified in the FTP/SFTP/TFTP section. If you select this option, select FTP or SFTP to transfer the configuration file. ◆ NFS Mounted Directory: Local directory of the NFS server for mounting files. ◆ CIFS Share – Saved Configurations: If restoring, select a saved configuration from the drop-down list. ◆ USB: If a USB thumb drive is loaded into one of the USB ports of the SLB branch office manager, and properly mounted, the configuration can be saved to or restored from this location. If you select this option, select the port in which the USB thumb drive is mounted; then click a saved configuration from the drop-down list. ◆ HTTPS: For saving, the browser will prompt the user to save the configuration. For restoring, the configuration will be uploaded to the Local Disk location. ◆ Manage: The Manage option allows you to view and delete all configurations saved to the selected location. This feature is available for the default, CIFS Share, and USB locations.
Preserve Configuration after Restore	<p>Allows the user to keep a subset of the current configuration after restoring a configuration or resetting to factory defaults.</p> <p>Select the checkbox for each part of the current configuration you want to keep, for example, Networking, Services, or Device Ports.</p>

3. Click **Apply**.

Note: If you selected an option that forces a reboot (restore configuration, update firmware, or reset factory defaults), the SLB unit automatically reboots at the end of the process.

Zero Touch Provisioning Configuration Restore

The Zero Touch Provisioning feature allows a factory defaulted SLB to acquire a default configuration from a DHCP server and TFTP server when it is booted. At boot-time, before the normal startup process, a unit will attempt to acquire network parameters and a configuration file, first over Eth1, and then over Eth2:

- ◆ The unit will broadcast on the Eth1 network port for a DHCP server on the local subnet, requesting DHCP options "TFTP Server" (DHCP option #66) and "Boot Filename" (DHCP option #67).
- ◆ If it receives both options from the DHCP server, and the Boot Filename is a valid SLB configuration filename ending in "-slccfg.tgz", it will attempt to download the Boot Filename from the TFTP Server.
- ◆ If it is able to download the Boot Filename from the TFTP Server, it will restore the configuration onto the SLB, and begin the normal startup process.
- ◆ If any of these steps fail for the Eth1 network port, it will repeat the process of trying to acquire a configuration over the Eth2 network port.
- ◆ After attempting to acquire a configuration over the Eth2 network port, the unit will begin the normal startup process.

Any results of attempting to acquire and restore a configuration file will be output to the console port and the system log. Configurations for firmware versions that are newer than the firmware version running on the unit will not be restored. Spaces are not supported in either the directory or filename portion of the Boot Filename path.

To manage configuration files:

The **Manage** option on the [Maintenance > Firmware & Configurations](#) page allows you to view all configurations saved to the selected location and delete any of the configurations. This feature is available for the default, CIFS Share, and USB locations.

1. On the [Maintenance > Firmware & Configurations](#) page, click the **Manage** link. The following page displays the name and the time and date the file was saved:

Figure 12-2 Manage Configuration Files

The screenshot shows the LANTRONIX SLB882/8824 web interface. At the top, there is a navigation bar with tabs for Network, Services, User Authentication, Devices, Maintenance, and Quick Setup. The Maintenance tab is selected, and the sub-page is 'Firmware & Configurations - Manage Files'. Below the navigation bar, there is a table titled 'Configurations - Local Disk' with the following columns: Name, Date/Time Saved, SSH Keys, SSL Certificate, and Scripts. Below the table, there are three buttons: 'Delete File', 'Download File', and 'Rename File', followed by a text input field labeled 'New File Name:'. The interface also includes a 'Logout' button, host information (Host: slb02fa, User: sysadmin), and a status bar at the bottom with various system logs and diagnostics links.

2. To delete files, select one or more files and click the **Delete File** button.
3. To download a new firmware file, click the **Download File** button.
4. To rename a listed file, select the file, type the new file name into the **New File Name** field, and click the **Rename File** button.

Administrative Commands

These commands for the command line interface correspond to the web page entries described above.

System Logs

The [Maintenance > System Logs](#) page allows you to view various system logs. (See [Chapter 7: Services on page 84](#) for more information about system logs.) You can also clear logs on this page.

To view system logs:

1. Click the **Maintenance** tab and select the **System Logs** option. The following page displays:

Figure 12-3 Maintenance > System Logs

The screenshot shows the LANTRONIX SLB882/8824 web interface. At the top, there is a navigation bar with tabs for Network, Services, User Authentication, Devices, Maintenance (selected), and Quick Setup. Below this is a sub-menu with links for Firmware/Config, System Log, Audit Log, Email Log, Diagnostics, Status/Reports, Events, LCD/Keypad, and Banners. The main content area is titled 'System Logs' and contains the following elements:

- Log:** A list of radio buttons for selecting the log type: All (selected), Network, Services, Authentication, Device Ports, Diagnostics, General, and Software.
- Level:** A list of radio buttons for selecting the log level: Error (selected), Warning, Info, and Debug.
- Starting at:** A section with a radio button for 'Beginning of Log' and a date/time picker set to September 21, 2001, 08:22:55 am.
- Ending at:** A section with a radio button for 'End of Log' and a date/time picker set to September 21, 2001, 08:22:55 am.
- At the bottom, there are two buttons: 'View Log' and 'Clear Log'.

2. Enter the following to define the parameters of the log you would like to view:

Log	Select the type(s) of log you want to view: <ul style="list-style-type: none"> ◆ All ◆ Network ◆ Services ◆ Authentication ◆ Device Ports ◆ Diagnostics ◆ General ◆ Software
Level	Select the alert level you want to view for the selected log: <ul style="list-style-type: none"> ◆ Error ◆ Warning ◆ Info ◆ Debug
Starting at	Select the starting point of the range you want to view: <ul style="list-style-type: none"> ◆ Beginning of Log: to view the log from the earliest available beginning time and date. ◆ Date: to view the log starting from a specific starting date and time.
Ending at	Select the endpoint of the range you want to view: <ul style="list-style-type: none"> ◆ End of Log: to view the log from the latest available ending time and date. ◆ Date: to view the log up to the last available log ending date and time.

3. Click the **View Log** button. Your specified system log displays. For example, if you select the type **All** and the level **Error**, the SLB branch office manager displays a log similar to this:

Figure 12-4 System Logs

The screenshot shows the Lantronix SLB882/8824 web interface. At the top, there is a header with the Lantronix logo and model number. Below the header, there is a navigation menu with tabs for Network, Services, User Authentication, Devices, Maintenance (selected), and Quick Setup. Under the Maintenance tab, there are sub-tabs for Firmware/Config, System Log (selected), Audit Log, Email Log, Diagnostics, Status/Reports, Events, LCD/Keypad, and Banners. The main content area is titled 'System Logs' and includes a 'Log: All - Error Level' dropdown, 'Email Output' and 'Stop Refresh' buttons, and a 'Comment:' field. The log display area shows a list of system events, including connection attempts and kernel rx misses.

```

Sep 21 08:09:59 2001 slb02fa SLC-SLB/portmap[24129]: connect from 172.19.100.90 to callit(100004):
request from unauthorized host
Sep 21 07:02:11 2001 slb02fa SLC-SLB/kernel: rx miss
Sep 21 06:16:56 2001 slb02fa SLC-SLB/kernel: rx miss
Sep 21 03:46:06 2001 slb02fa SLC-SLB/kernel: rx miss
Sep 21 02:59:12 2001 slb02fa SLC-SLB/portmap[23981]: connect from 172.19.100.170 to callit(100004):
request from unauthorized host
Sep 21 01:00:11 2001 slb02fa SLC-SLB/kernel: rx miss
Sep 20 22:24:20 2001 slb02fa SLC-SLB/kernel: rx miss
Sep 20 21:21:09 2001 slb02fa SLC-SLB/portmap[21025]: connect from 172.19.100.170 to callit(100004):
request from unauthorized host
Sep 20 21:08:48 2001 slb02fa SLC-SLB/kernel: rx miss
Sep 20 21:08:48 2001 slb02fa SLC-SLB/kernel: rx miss
Sep 20 20:39:29 2001 slb02fa SLC-SLB/portmap[16654]: connect from 172.19.100.90 to callit(100004):
request from unauthorized host
Sep 20 20:14:26 2001 slb02fa SLC-SLB/portmap[14030]: connect from 172.19.39.248 to callit(100004):
request from unauthorized host
Sep 20 19:49:20 2001 slb02fa SLC-SLB/kernel: rx miss
Sep 20 10:58:35 2001 slb02fa SLC-SLB/portmap[20718]: connect from 172.19.100.170 to callit(100004):
request from unauthorized host
Sep 20 09:25:01 2001 slb02fa SLC-SLB/portmap[10930]: connect from 172.19.100.90 to callit(100004):

```

From a queried system log (i.e., [Figure 12-4](#)), you may email this information to a specific individual or to Lantronix Technical Support. See [Emailing Logs and Reports \(on page 241\)](#).

To clear system logs:

1. From the [Maintenance > System Logs](#) page, select **SLB Maintenance - System Logs**.
2. Click the **Clear Log** button to clear all log information.

System Log Commands

Go to [System Log Commands \(on page 329\)](#) to view CLI commands which correspond to the web page entries described above.

Audit Log

The [Maintenance > Audit Log](#) page displays a log of all actions that have changed the configuration of the SLB. The audit log is disabled by default. Use the [Services > SSH/Telnet/Logging](#) page ([Chapter 7: Services](#)) to enable the audit log and to configure its maximum size.

Each entry in the log file contains a date/time stamp, user login, and the action performed by the user. The user may clear the log file and sort the log by date/time, user, and command. The audit log is saved through SLB branch office manager reboots.

1. Click the **Maintenance** tab and select the **Audit Log** option. The following page displays:

Figure 12-5 Maintenance > Audit Log

The screenshot shows the LANTRONIX SLB882/8824 web interface. At the top, there is a navigation bar with tabs for Network, Services, User Authentication, Devices, Maintenance (selected), and Quick Setup. Below the navigation bar, there are several menu items: Firmware/Config, System Log, Audit Log (selected), Email Log, Diagnostics, Status/Reports, Events, LCD/Keypad, and Banners. The main content area is titled 'Audit Log' and includes a 'Help?' link. The log is sorted by 'Date/Time'. There are buttons for 'User', 'Command', 'Clear Log', and 'Stop Refresh'. An 'Email Log' button is also present, along with 'Comment:' and 'to:' input fields. The log entries are as follows:

Sep 21 07:50:13 2001	sysadmin	Web Authentication Success for user sysadmin
Sep 18 04:10:06 2001	sysadmin	Web Authentication Success for user sysadmin
Sep 18 01:36:01 2001	sysadmin	Web Authentication Success for user sysadmin
Sep 18 01:35:57 2001	sysadmin	Web Authentication Failure for user jchen
Sep 18 01:35:40 2001	sysadmin	Web Authentication Failure for user jchen
Sep 17 11:03:11 2001	sysadmin	USB device inserted at U1
Sep 17 11:03:11 2001	sysadmin	USB U1 port settings updated
Sep 17 11:01:31 2001	sysadmin	USB device ejected at U1
Sep 17 11:01:31 2001	sysadmin	USB U1 port settings updated
Sep 17 10:58:05 2001	sysadmin	USB device inserted at U1
Sep 17 10:58:05 2001	sysadmin	USB U1 port settings updated
Sep 15 04:12:31 2001	sysadmin	USB device inserted at U2

2. To select a sort option, click the appropriate button:
 - ◆ To sort by date and time, click the **Date/Time** button (this is the default) to sort by Date/Time.
 - ◆ To sort by user, click the Sort by **User** button.
 - ◆ To sort by command/action, click the **Command** button.
3. To email this log, follow the instructions in [Emailing Logs and Reports \(on page 241\)](#).
4. To clear the log, click the **Clear Log** button.
5. To freeze or stop automatic refreshing of the log, click the **Stop Refresh** button.

Email Log

The [Maintenance > Email Log](#) page displays a log of all attempted emails. The log file can be cleared from here. The email log is saved through SLB unit reboots.

1. Click the Maintenance tab and select the Email Log option. The following page displays:

Figure 12-6 Maintenance > Email Log

The screenshot shows the LANTRONIX SLB882/8824 web interface. At the top, there is a navigation menu with tabs for Network, Services, User Authentication, Devices, Maintenance (selected), and Quick Setup. Below the navigation menu, there are links for Firmware/Config, System Log, Audit Log, Email Log (selected), Diagnostics, Status/Reports, Events, LCD/Keypad, and Banners. The main content area is titled "Email Log" and includes a "Help?" link. There are two buttons: "Clear Log" and "Email Log". To the right of these buttons are input fields for "Comment:" and "to:". Below the buttons is a "Stop Refresh" button. The main content area displays the following statistics:

```
Send Failures: 0
Emails Sent: 0
Bytes Sent: 0
```

2. To email this log, follow the instructions in [Emailing Logs and Reports \(on page 241\)](#).
3. To clear the log, click the **Clear Log** button.

Diagnostics

The [Maintenance > Diagnostics](#) page provides methods for diagnosing problems such as network connectivity and device port input/output problems. You can use equivalent commands on the command line interface. An additional diagnostic, loopback, is only available as a command.

1. Click the **Maintenance** tab and select the **Diagnostics** option. The following page displays:

Figure 12-7 Maintenance > Diagnostics

The screenshot shows the LANTRONIX SLB882/8824 web interface. At the top, there's a status bar with 'Logout', 'Host: slb02fa', and 'User: sysadmin'. A navigation menu includes 'Network', 'Services', 'User Authentication', 'Devices', 'Maintenance' (selected), and 'Quick Setup'. Below this is a sub-menu with 'Firmware/Config', 'System Log', 'Audit Log', 'Email Log', 'Diagnostics' (selected), 'Status/Reports', 'Events', 'LCD/Keypad', and 'Banners'. The main content area is titled 'Diagnostics' and contains a list of diagnostic tools with checkboxes and configuration options:

- Select Diagnostics:**
 - All
 - Arp Table
 - Netstat
 - Protocol: All TCP UDP
 - Host Lookup
 - Hostname:
 - Ping
 - Hostname:
 - Ethernet Port: Both Eth1 Eth2
 - IPv6:
 - Send Packet
 - Protocol: TCP UDP
 - Hostname:
 - Port:
 - String:
 - Count:
 - Loopback
 - Device Port:
 - Test: Internal External
 - SLB Internals

At the bottom of the diagnostics section is a 'Run Diagnostics' button.

2. Select **Diagnostics** from checklist (one or more diagnostic methods you want to run, or select **All** to run them all):

ARP Table	Address Resolution Protocol (ARP) table used to view the IP address-to-hardware address mapping.
Netstat	Displays network connections. If you select the checkbox, select the TCP or UDP protocol, or select All for both protocols to control the output of the Netstat report.
Host Lookup	Select to verify that the SLB branch office manager can resolve the host name into an IP address (if DNS is enabled). If selected, also enter a host name in the corresponding Hostname field,
Ping	Select to verify that the host is up and running. If selected, also do the following: <ul style="list-style-type: none"> ◆ Enter a host name in the corresponding Hostname field ◆ Specify Ethernet Port (Both, Eth1 or Eth2) ◆ Check IPv6 if... need text.

Send Packet	<p>This option sends an Ethernet packet out one of the Ethernet ports, mainly as a network connectivity test. For UDP, the number of times the string is sent is equal to the number of packets sent. For TCP, the number of times the string is sent may (or may not) be equal to the number of packets sent, because TCP controls how data is packetized and sent out. Enter the following:</p> <ul style="list-style-type: none"> ◆ Protocol: Select the type of packet to send (TCP or UDP). ◆ Hostname: Specify a host name or IP address of the host to send the packet to. ◆ Port: Specify a TCP or UDP port number of the host to send the packet to. ◆ String: Enter a set of up to 64 characters. The string is encapsulated in the packet (so you could use a network sniffer to track the packet and, by looking at its contents, verify that it was sent). ◆ Count: The count is the number of times the string is sent.
Loopback	<p>Specify loopback information:</p> <ul style="list-style-type: none"> ◆ Device Port ◆ Select either an Internal or External test
SLB Internals	Select to display information on the internal memory, storage and processes of the SLB.

3. Click the **Run Diagnostics** button. The *Diagnostics Report* page displays.

Figure 12-8 Diagnostics Report

The screenshot shows the LANTRONIX SLB882/8824 web interface. At the top, there's a navigation bar with buttons for Network, Services, User Authentication, Devices, Maintenance (selected), and Quick Setup. Below this is a sub-menu with links for Firmware/Config, System Log, Audit Log, Email Log, Diagnostics (selected), Status/Reports, Events, LCD/Keypad, and Banners. The main content area is titled 'Diagnostics' and shows a 'Diagnostic Output: Arp Table' section. To the right of this section are an 'Email Output' button and a 'Comment:' field with a 'to:' field below it. The 'Arp Table' output is as follows:

Address	HWtype	HWaddress
Rochelle1-M265.int.lant	ether	00:25:11:8d:4d:8f
aeolus.eng.lantronix.co	ether	00:1b:21:0e:3d:f4

4. To email this report, follow the instructions in *Emailing Logs and Reports (on page 241)*.

Dagnostic Commands

Go to *Dagnostic Commands (on page 295)* to view CLI commands which correspond to the web page entries described above.

Status/Reports

On this page, you can view the status of the SLB ports and power supplies and generate a selection of reports.

Note: Status and statistics shown on the web interface represent a snapshot in time. To see the most recent data, you must reload the web page.

1. Click the **Maintenance** tab and select the **Status/Reports** option. The following page displays:

Figure 12-9 Maintenance > Status/Reports

The screenshot shows the LANTRONIX SLB882/8824 web interface. At the top, there is a navigation bar with tabs for Network, Services, User Authentication, Devices, Maintenance (selected), and Quick Setup. Below the navigation bar, there are links for Firmware/Config, System Log, Audit Log, Email Log, Diagnostics, Status/Reports (selected), Events, LCD/Keypad, and Banners. The main content area is divided into two sections. The left section shows the status of various components: Eth1: Up (green), Eth2: Down (red), Primary Inlet: Failed (red), Secondary Inlet: Ok (green), Console Port: Not Connected (red), Internal Temperature: 32 °C (89 °F) (green), and Power Outlet P1 through P8: Off (red). The right section is titled 'Device Ports' and shows a table of port statuses: 1: Ok (green), 2: Ok (green), 3: Ok (green), 4: Ok (green), 5: Ok (green), 6: Ok (green), 7: Ok (green), and 8: Ok (green). Below the status information, there is a 'View Report' section with checkboxes for different report types: All, Port Status, Port Counters, IP Routes, Connections, System Configuration - Complete, System Configuration - Basic, System Configuration - Authentication, and System Configuration - Devices. A 'Generate Report' button is located at the bottom of the report selection area.

The top half of the page displays the status of each port, power supply, and power outlet:

- ◆ **Green** indicates that the port connection or power supply is active and functioning correctly.
- ◆ **Red** indicates an error or failure or that the device is off.

2. Select the desired reports to view under **View Report**:

View Report

All	Displays all reports.
-----	-----------------------

Port Status	Displays the status of each device port: mode, user, any related connections, and serial port settings.
Port Counters	Displays statistics related to the flow of data through each device port.
IP Routes	Displays the routing table.
Connections	Displays all active connections for the SLB: Telnet, SSH, TCP, UDP, device port, and modem.
System Configuration – Complete	Displays a complete snapshot of the SLB settings.
System Configuration – Basic	Displays a snapshot of the SLB's basic settings (for example, network, date/time, routing, services, console port).
System Configuration – Authentication	Displays a snapshot of authentication settings only (including a list of all localusers).
System Configuration - Devices	Displays a snapshot of settings for each device port, USB Port, Modem, and Host Lists.

3. Click the **Generate Report** button. In the upper left of the *Generated Status/Reports* page displays a list of reports generated.

Figure 12-10 Generated Status/Reports

The screenshot shows the LANTRONIX SLB882/8824 web interface. At the top, there is a navigation bar with buttons for Network, Services, User Authentication, Devices, Maintenance, and Quick Setup. The 'Maintenance' button is highlighted. Below the navigation bar, there is a 'Status/Reports' section with a 'Help?' link. The main content area shows a 'Report(s):' section with an 'Email Output' button and a 'Comment:' field. Below this, there is a 'Port Status' section with a table of port information.

Device Port:	Name:	Mode:	DSR/CD:	DTR:	CTS:	RTS:
1	Port-1	Idle	Yes	Yes	Yes	Yes
2	Port-2	Idle	Yes	Yes	Yes	Yes
3	Port-3	Idle	Yes	Yes	Yes	Yes
4	Port-4	Idle	Yes	Yes	Yes	Yes
5	Port-5	Idle	Yes	Yes	Yes	Yes

4. To email these report(s), follow the instructions in *Emailing Logs and Reports (on page 241)*.

Status Commands

Go to [Status Commands \(on page 328\)](#) to view CLI commands which correspond to the web page entries described above.

Emailing Logs and Reports

The following logs and reports can be directly emailed to a specific individual or to Lantronix Technical Support directly from the log page:

- ◆ System Log (i.e., [Figure 12-4](#))
- ◆ Audit Log (i.e., [Figure 12-5](#))
- ◆ Email Log (i.e., [Figure 12-6](#))
- ◆ Diagnostic Reports (i.e., [Figure 12-8](#))
- ◆ Status/Reports (i.e., [Figure 12-10](#))

To email a log to an individual:

1. In the **Comment** field of a particular log or report page, enter a comment (if desired).
2. Select the **to** field beside the empty field where you then enter the person's email address.
3. Press the **Email Output** button. An email is immediately sent out and a confirmation appears on the screen.

Figure 12-11 Emailed Log or Report

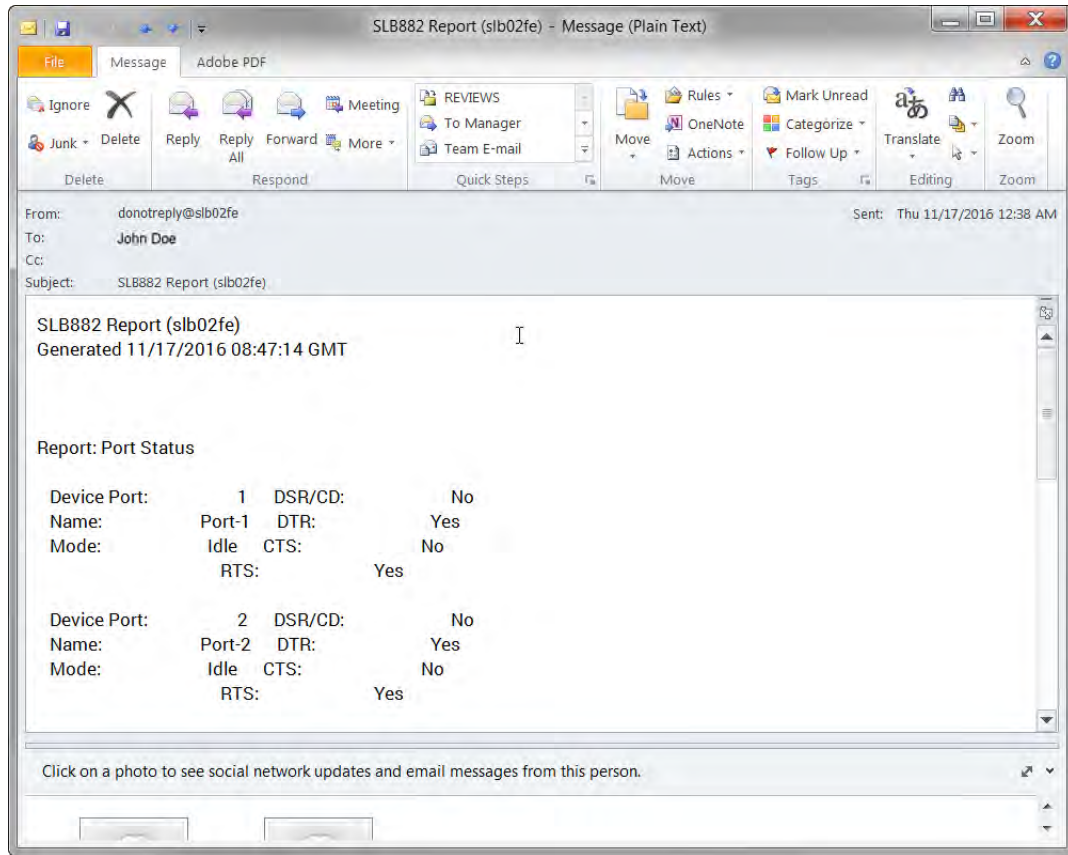

Events

On this [Maintenance > Events](#) page, you can define what action you want to take for events that may occur in the SLB.

1. Click the **Maintenance** tab and select the **Events** option. The following page displays:

Figure 12-12 Maintenance > Events

LANTRONIX® SLB882

Logout User: sysadmin

Select port for: Configuration WebSSH (DF only) Connected Device (DF only)

Network Services User Authentication Devices Maintenance Quick Setup

Firmware/Config System Log Audit Log Email Log Diagnostics Status/Reports Events LCD/Keypad Banners

Events [Help?](#)

Event Trigger: Action:

Ethernet: Eth1 Eth2

Modem Connection on: USB Port U1 USB Port U2 Device Port:

NMS/Host to forward trap to:

SNMP Community:

SNMP Trap OID:

Email Address:

To edit or delete an event, select the radio button in the right column below.

Events			
Id	Event Trigger	Action/Alarm	Options

2. Enter the following:

Event Trigger	From the drop-down list, select the type of incident that triggers an event. Currently, the options are: <ul style="list-style-type: none"> ◆ Receive Trap ◆ Temperature Over/Under Limit (for Sensorsoft devices) ◆ Humidity Over/Under Limit (for Sensorsoft devices) ◆ Device Port Data Drop ◆ Current Over Threshold ◆ Power Inlet Status Change ◆ No Internal Modem Dial Tone
Action	From the drop-down list, select the action taken because of the trigger. For example, the action can be writing an entry into the syslog with details of the event or sending the trap(s) to the Ethernet or modem connection.
Ethernet	For actions that require an Ethernet connection (for example, Forward All Traps to Ethernet), select the Ethernet port to use.
Modem Connection on	For actions that require a modem connection (for example, Forward All Traps to a Modem Connection), select which device port or USB port with a modem connection to use.
NMS/Host to forward trap to	For actions that forward a trap, enter the IP address of the computer to forward the trap to. The computer does not have to be an SNMP NMS; it just has to be capable of receiving SNMP traps.
SNMP Community	Forwarded traps are sent with this SNMP community value There is no default.

SNMP Trap OID	Enter a unique identifier for an SNMP object. (An SNMP object is anything that can hold a value and can be read using an SNMP "get" action.) The OID consists of a string of numbers separated by periods (for example, 1.1.3.2.1). Each number is part of a group represented by the number on its left.
Email Addresses	Enter an email address to receive email alerts.

3. You have the following options:

- ◆ To add the defined event, click the **Add Event** button. The event displays in the Events table at the bottom of the page.
- ◆ To edit an event, select the event from the Events table and click the **Edit Event** button. The [Maintenance > Events](#) page displays the event.
- ◆ To delete an event, select the event from the Events table and click the **Delete Event** button. A message asks for confirmation. Click **OK**.

4) To save, click **Apply**.

Events Commands

Go to [Events Commands \(on page 299\)](#) to view CLI commands which correspond to the web page entries described above.

LCD/Keypad

The LCD has a series of screens, consisting of 2 lines of 24 characters each. Specific screens and the display order can be configured. The keypad associated with the LCD can also be configured. The types of screens include: current time, network settings, console settings, date and time, release version, location, and custom user strings.

Enabling the **Auto-Scroll LCD Screens** option enables scrolling through the screens and pausing the number of seconds specified by the **Scroll Delay** between each screen. After any input to the keypad, the LCD waits until the keypad has been idle for the number of seconds specified by the **Idle Delay** before scrolling of the screens continues.

To configure the LCD and Keypad:

1. Click the **Maintenance** tab and select the **LCD/Keypad** option.

Figure 12-13 Maintenance > LCD/Keypad

The screenshot shows the LANTRONIX SLB882/8824 maintenance interface. At the top, there is a navigation bar with tabs for Network, Services, User Authentication, Devices, Maintenance (selected), and Quick Setup. Below this is a sub-menu with links for Firmware/Config, System Log, Audit Log, Email Log, Diagnostics, Status/Reports, Events, LCD/Keypad (selected), and Banners. The main content area is titled "LCD/Keypad" and contains two sections: "LCD Settings" and "Keypad Settings".

LCD Settings:

- Enabled screens (in display order):** Power, Network, Console, Date/Time, Release. Navigation buttons (up, down, left, right) are present.
- Disabled screens:** Current Time, Device Ports, Location, User Strings, Internal Temp. Navigation buttons (left, right) are present.
- User Strings - Line 1:** [Text input field]
- Line 2:** [Text input field]
- Auto-Scroll LCD Screens:**
- Scroll Delay:** 5 seconds
- Idle Delay:** 10 seconds
- Apply** button





Keypad Settings:

- Keypad Locked:**
- Restore Factory Defaults Password:** [Password field]
- Retype Password:** [Password field]

To configure the LCD through the SLB user interface:

The screens that are currently enabled are displayed in order in the left Enabled screens list.

Note: See *Front Panel LCD Display and Keypads (on page 42)* to set up the basic parameters using the SLB device.

1. Select a screen to be removed from the **Enabled Screens** and click the  button. The screen moves to the **Disabled Screens** list to the right.
2. Select a screen to be added from the **Disabled Screens** list and click the  button. The screen is added to the **Enabled Screens** to the left.
3. Select a screen in the **Enabled Screens** list and click the  or  button to change the order of the screens.

Note: The User Strings screen displays the 2 lines defined by the User Strings - Line 1 and Line 2 fields. By default, these user strings are blank.

4. Click **Apply** to save.

To configure the Keypad:

1. Enter the following fields.

Keypad Locked	Select this to lock out any input to the keypad. The default is for the keypad to be unlocked.
Restore Factory Defaults Password / Retype Password	Enter the 6 digit key sequence entered at the keypad to restore the SLB unit to factory defaults. The default is 999999 .

2. Click **Apply** to save.

LCD/Keypad Commands

Go to [Administrative Commands \(on page 255\)](#) to view CLI commands which correspond to the web page entries described above.

Banners

The [Maintenance > Banners](#) page allows the system administrator to customize text messages that display to users.

To configure banner settings:

1. Click the **Maintenance** tab and select **Banners** option.

Figure 12-14 Maintenance > Banners

LANTRONIX[®] SLB882/8824

Logout Host: slb02fe User: sysadmin

Select port for Configuration WebSSH (DP only) Connected Device (DP only)

Network Services User Authentication Devices Maintenance Quick Setup

Firmware/Config System Log Audit Log Email Log Diagnostics Status/Reports Events LCD/Keypad Banners

Banners [Help?](#)

Welcome Banner:

Login Banner:

Logout Banner:

SSH Banner:

Note: Line feeds can be included in the banners with the '\n' character sequence.
The web banner can be configured [here](#).

Apply

2. Enter the following fields.

Welcome Banner	The text to display on the web interface or command line interface before the user logs in. May contain up to 1024 characters. Single quote and double quote characters are not supported. Welcome to the SLB is the default. Note: To create more lines use the \n character sequence.
-----------------------	---

Login Banner	The text to display on the command line interface after the user logs in. May contain up to 1024 characters. Single quote and double quote characters are not supported. Default is blank. <i>Note: To create more lines, use the \n character sequence.</i>
Logout Banner	The text to display on the command line interface after the user logs out. May contain up to 1024 characters. Single quote and double quote characters are not supported. Default is blank. <i>Note: To create more lines use, the \n character sequence.</i>
SSH Banner	The text to display when a user logs into the SLB unit via SSH, prior to authentication. Single quote and double quote characters are not supported. May contain up to 1024 characters. Blank by default. <i>Note: To create more lines use the \n character sequence.</i>

3. Click **Apply** to save.

Banner Commands

Go to [Administrative Commands \(on page 255\)](#) to view CLI commands which correspond to the web page entries described above.

13: Application Examples

Each SLB branch office manager has multiple serial ports and two network ports. Each serial port can be connected to the console port of an IT device. Using a network port (in-band) or a modem (out-of-band) for dial-up connection, an administrator can remotely access any of the connected IT devices using Telnet or SSH.

Figure 13-1 SLB - Branch Office Manager Configuration

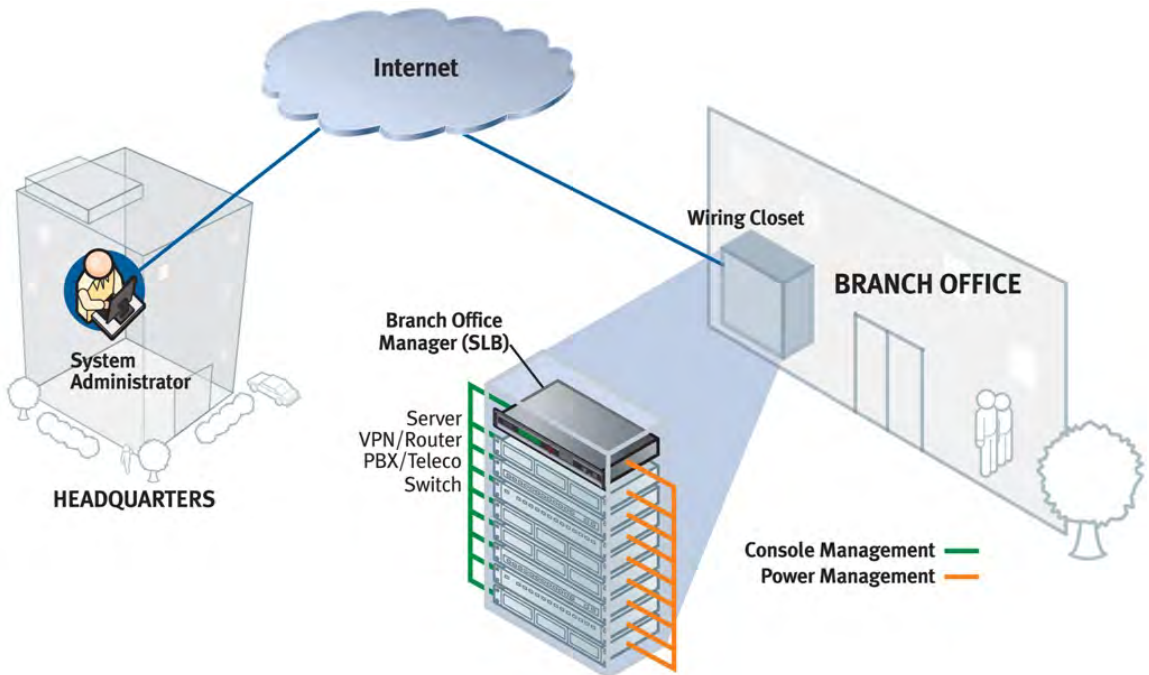

This chapter includes three typical scenarios for using the SLB unit. The scenarios assume that the SLB device is connected to the network and has already been assigned an IP address. In the examples, we use the command line interface. You can do the same things using the web page interface except for directly interacting with the SLB unit (`direct` command).

Telnet/SSH to a Remote Device

The following figure shows a Sun server connected to port 2 of the SLB.

Figure 13-2 Remote User Connected to a SUN Server via the SLB

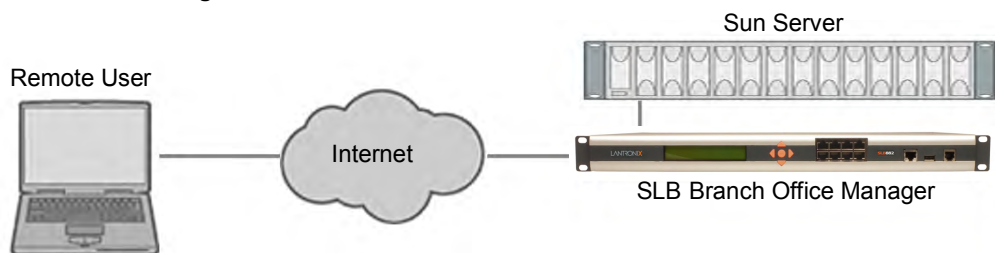

In this example, the sysadmin would:

1. Display the current settings for device port 2:

```
[SLB]> show deviceport port 2
__Current Device Port
Settings_____
Number: 2  Name: Port-2

Modem Settings-----Data Settings-----IP Settings-----
Modem State: disabled      Baud Rate: 9600          Telnet: disabled
Modem Mode: text           Data Bits: 8             Telnet Port: 2002
Timeout Logins: disabled   Stop Bits: 1            SSH: disabled
Local IP: negotiate        Parity: none             SSH Port: 3002
Remote IP: negotiate       Flow Control: xon/xoff   IP: <none>
Authentication: PAP        Logins: disabled
CHAP Host: <none>          Break Sequence: \x1bB
CHAP Secret: <none>        Check DSR: disabled
NAT: disabled              Close DSR: disabled
Dial-out Login: <none>
Dial-out Password: <none>
Dial-out Number: <none>
Dial-back Number: usernumber
Initialization Script: <none>

Logging Settings-----
Local Logging: disabled     USB Logging: disabled
Email Logging: disabled     Log to: upper slot
Byte Threshold: 100         Max number of files: 10
Email Delay: 60 seconds     Max size of files: 2048
Restart Delay: 60 seconds
Email To: <none>
Email Subject: Port %d Logging
Email String: <none>
NFS File Logging: disabled
Directory to log to: <none>
Max number of files: 10
Max size of files: 2048
```

2. Change the baud to 57600 and disable flow control:

```
[SLB]> set deviceport port 2 baud 57600 flowcontrol none
Device Port settings successfully updated.
```

3. Connect to the device port:

```
[SLB]> connect direct deviceport 2
```

4. View messages from the SUN server console:

```
Mar 15 09:09:44 tssf280r sendmail[292]: [ID 702911 mail.info] starting
daemon (8.12.2+Sun): SMTP+queueing@00:15:00
Mar 15 09:09:44 tssf280r sendmail[293]: [ID 702911 mail.info] starting
daemon (8.12.2+Sun): queueing@00:15:00
Mar 15 14:44:40 tssf280r sendmail[275]: [ID 702911 mail.info] starting
daemon (8.12.2+Sun): SMTP+queueing@00:15:00
Mar 15 14:44:40 tssf280r sendmail[276]: [ID 702911 mail.info] starting
daemon (8.12.2+Sun): queueing@00:15:00
```

5. Reboot the SUN server:

```
Reboot
<shutdown messages from SUN>
```

6. Use the escape sequence to escape from direct mode back to the command line interface.

Dial-in (Text Mode) to a Remote Device

This example shows a modem connected to an SLB device port, and a Sun server connected to another SLB device port. You can configure the modem for text mode dial-in, so a remote user can dial into the modem using a terminal emulation program and access the Sun server. (HyperTerminal™, which comes with the Microsoft® Windows™ operating system, is an example of a terminal emulation program.)

Figure 13-3 Dial-in (Text Mode) to a Remote Device

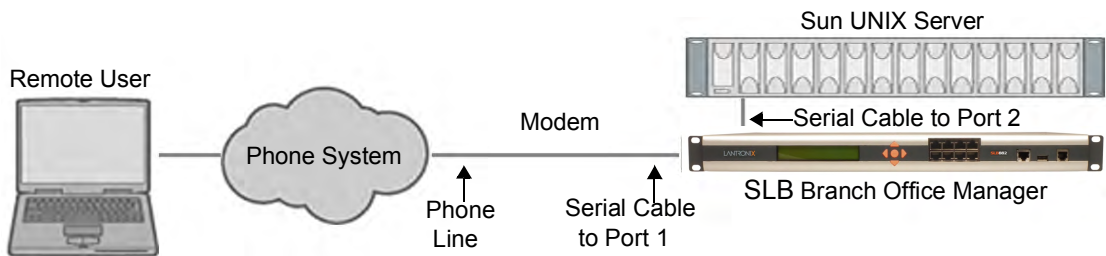

In this example, the sysadmin would:

1. Configure the device port that the modem is connected to for dial-in:

```
[SLB]> set deviceport port 1 modemmode text
Device Port settings successfully updated.
[SLB]> set deviceport port 1 initscript "AT&F&K3&C1&D2%COA"
Device Port settings successfully updated.
[SLB]> set deviceport port 1 auth pap
Device Port settings successfully updated.
[SLB]> set deviceport port 1 localsecret "password"
Device Port settings successfully updated.
[SLB]> set deviceport port 1 modemstate dialin
Device Port settings successfully updated.
[SLB]>
```

2. Configure the device port that is connected to the console port of the Sun UNIX server:

```
[SLB]> set deviceport port 2 baud 57600 flowcontrol none
Device Port settings successfully updated.
```

3. Dial into the SLB branch office manager via the modem using a terminal emulation program on a remote PC. A command line prompt displays.

4. Log into the SLB.

```
CONNECT 57600
Welcome to the SLB
login: sysadmin
Password:
```

```
Welcome to the Secure Lantronix Branch Office Manager
Model Number: SLB882
For a list of commands, type 'help'.
[SLB]>
```

5. Connect to the SUN Unix server using the direct command.

```
[SLB]> connect direct deviceport 2
SunOS 5.7
login: frank
Password:
Last login: Wed Jul 14 16:07:49 from computer
Sun Microsystems Inc.SunOS 5.7Generic October 1998
SunOS computer 5.7 Generic_123485-05 sun4m sparc SUNW,SPARCstation-20
$
```

6. Use the escape sequence to escape from direct mode back to the command line interface.

Local Serial Connection to Network Device via Telnet

This example shows a terminal device connected to an SLB device port, and a Sun server connected over the network to the SLB. When a connection is established between the device port and an outbound Telnet session, users can access the Sun server as though they were directly connected to it. (See [Chapter 10: Connections on page 180](#)).

Figure 13-4 Local Serial Connection to Network Device via Telnet

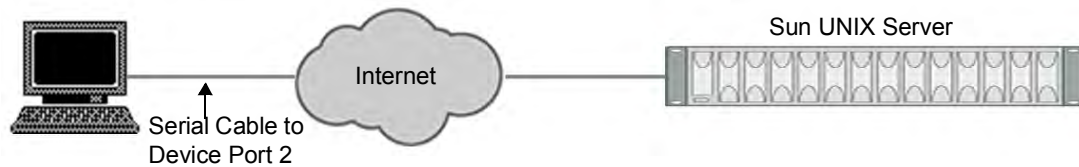

In this example, the sysadmin would:

1. Display the current settings for device port 2:

```
[SLB]> show deviceport port 2
__Current Device Port
Settings_____
Number: 2 Name: Port-2
Modem Settings-----Data Settings-----IP Settings-----
Modem State: disabled      Baud Rate: 9600      Telnet: disabled
Modem Mode: text           Data Bits: 8         Telnet Port: 2002
Timeout Logins: disabled   Stop Bits: 1        SSH: disabled
Local IP: negotiate        Parity: none         SSH Port: 3002
Remote IP: negotiate       Flow Control: xon/xoff IP: <none>
Authentication: PAP        Logins: disabled
CHAP Host: <none>          Break Sequence: \x1bB
CHAP Secret: <none>       Check DSR: disabled
NAT: disabled              Close DSR: disabled
Dial-out Login: <none>
Dial-out Password: <none>
Dial-out Number: <none>
```

Dial-back Number: usernumber
 Initialization Script: <none>

```
Logging Settings-----
Local Logging: disabled      USB Logging: disabled
Email Logging: disabled     Log to: upper slot
Byte Threshold: 100         Max number of files: 10
Email Delay: 60 seconds     Max size of files: 2048
Restart Delay: 60 seconds
Email To: <none>
Email Subject: Port %d Logging
Email String: <none>
NFS File Logging: disabled
Directory to log to: <none>
Max number of files: 10
Max size of files: 2048
```

2. Change the serial settings to match the serial settings for the vt100 terminal - changes baud to 57600 and disables flow control:

```
[SLB]> set deviceport port 2 baud 57600 flowcontrol none
Device Port settings successfully updated.
```

3. Create a connection between the vt100 terminal connected to device port 2 and an outbound telnet session to the server. (The IP address of the server is 192.168.1.1):

```
[SLB]> connect bidirection 2 telnet 192.168.1.1
Connection settings successfully updated.
```

4. At the VT100 terminal, hit <return> a couple of times. The Telnet prompt from the server displays:

```
Trying 192.168.1.1...
Connected to 192.168.1.1.
Escape character is '^]'.
```

```
Sun OS 8.0
login:
```

At this point, a user can log in and interact with the Sun server at the VT100 terminal as if directly connected to the server.

14: Command Reference

After an introduction to using commands, this chapter lists and describes all of the commands available on the SLB command line interface accessed through Telnet, SSH, or a serial connection. The commands are in alphabetical order by category.

Introduction to Commands

Following is some information about command syntax, command line help, and tips for using commands.

Command Syntax

Commands have the following format:

```
<action> <category> <parameter(s)>
```

where

<action> is set, show, connect, admin, diag, or logout.

<category> is a group of related parameters whose settings you want to configure or view. Examples are ntp, deviceport, and network.

<parameter(s)> is one or more name-value pairs in one of the following formats:

<parameter name> <aa bb>	User must specify one of the values (aa or bb) separated by a vertical line (). The values are in all lowercase and must be entered exactly as shown. Bold indicates a default value.
<parameter name> <Value>	User must specify an appropriate value, for example, an IP address. The parameter values are in mixed case. Square brackets [] indicate optional parameters.

Table 14-1 Actions and Category Options

Action	Category
set	auth cflow cifs cli command consoleport datetime deviceport groups history hostlist ipfilter kerberos ldap localusers log menu network nfs nis ntp password perfmon power radius remoteusers routing script services site slcnetwork sshkey tacacs+ temperature usb vpn
show	auth auditlog cflow cifs cli connections consoleport datetime deviceport emaillog groups history hostlist ipfilter kerberos ldap localusers log menu network nfs nis ntp perfmon portcounters portstatus power radius remoteusers routing script services site slcnetwork sshkey sysconfig syslog sysstatus tacacs+ temperature usb user vpn
connect	bidirection direct global listen restart script terminate unidirection

Action	Category
diag	arp internals lookup loopback netstat nettrace perfstat ping ping6 sendpacket traceroute
admin	banner clear config events firmware ftp keypad lcd memory quicksetup reboot shutdown site version web
logout	Terminates CLI session.

Command Line Help

For general Help and to display the commands to which you have rights, type:

```
help
```

For general command line Help, type:

```
help command line
```

For more information about a specific command, type help followed by the command, for example:





```
help set network or help admin firmware
```

Tips

- ◆ Type enough characters to identify the action, category, or parameter name uniquely. For parameter values, type the entire value. For example, you can shorten:

```
set network port 1 state static ipaddr 122.3.10.1 mask 255.255.0.0
```

 to

```
se net po 1 st static ip 122.3.10.1 ma 255.255.0.0
```
- ◆ Use the Tab key to automatically complete action, category, or parameter names. Type a partial name and press **Tab** either to complete the name if only one is possible, or to display the possible names if more than one is possible. Following a space after the preceding name, Tab displays all possible names.
- ◆ Should you make a mistake while typing, backspace by pressing the Backspace key and/or the Delete key, depending on how you accessed the interface. Both keys work if you use VT100 emulation in your terminal access program when connecting to the console port. Use the left  and right  arrow keys to move within a command.
- ◆ Use the up  and down  arrows to scroll through previously entered commands. If desired, select one and edit it. You can scroll through up to 100 previous commands entered in the session.
- ◆ To clear an IP address, type 0.0.0.0, or to clear a non-IP address value, type CLEAR.
- ◆ When the number of lines displayed by a command exceeds the size of the window (the default is 25), the command output is halted until the user is ready to continue. To display the next line, press **Enter**, and to display the page, press the space bar. You can override the number of lines (or disable the feature altogether) with the set cli command.

- ◆ Keyboard Shortcuts:
 - Control-a: move to the start of the line
 - Control-e: move to the end of the line
 - Control-b: move back to the start of the current word
 - Control-f: move forward to the end of the next word
 - Control-u: erase from cursor to the beginning of the line
 - Control-k: erase from cursor to end of the line

Administrative Commands

admin banner login

Syntax

```
admin banner login <Banner Text>
```

Description

Configures the banner displayed after the user logs in.

Note: To go to the next line, type `\n` and press **Enter**.

admin banner logout

Syntax

```
admin banner logout <Banner Text>
```

Description

Configures the banner displayed after the user logs out.

Note: To go to the next line, type `\n` and press **Enter**.

admin banner show

Syntax

```
admin banner show
```

Description

Displays the welcome, login, and logout banners.

admin banner welcome**Syntax**

```
admin banner welcome <Banner Text>
```

Description

Configures the banner displayed before the user logs in.

Note: To go to the next line, type `\n` and press **Enter**.

admin clear**Syntax**

```
admin clear tmpdir
```

Description

Clears the directory holding temporary files.

admin config delete**Syntax**

```
admin config delete <Config Name> location <default|nfs|cifs|usb>
[usbport <u1>]
admin config rename <Config Name> location <default|nfs|cifs|usb>
[usbport <u1>]
nfsdir <NFS Mounted Directory>
```

Description

Deletes a configuration.

admin config factorydefaults**Syntax**

```
cfokp"eqphki"hcevqt{fghcwnvu"}ucxguujmg{u">gpcdng~fkucdng@_"}ucxguunegtv"
<enable|disable> [preserveconfig <Config Params to Preserve>]
savescripts <enable|disable>
```

<Config Params to Preserve> is a comma-separated list of current configuration parameters to retain after the config restore or factorydefaults:

nt	Networking
sv	Services
dt	Date/Time
po	Power Outlets
lu	Local Users
dp	Device Ports
ub	USB Port

Description

Restores the SLB branch office manager to factory default settings.

admin config restore

Syntax

```
cfokp"eqphki"tguvqtg">Eqphki"Pcog@"nqecvkqp"
>fghcwnv~hvr~uhvr~phu~ekhu~wud@" ]phufkt">PHU"Oqwpvgf"Fkt@_" ]wudrqtv"
<u1>_"[preserveconfig <Config Params to Preserve>]
savesshkeys <enable|disable>
savesslcert <enable|disable>
savescripts <enable|disable>
```

<Config Params to Preserve> is a comma-separated list of current configuration parameters to retain after the config restore or factorydefaults:

nt	Networking
sv	Services
dt	Date/Time
po	Power Outlets
lu	Local Users
dp	Device Ports
ub	USB Port

Description

Restores a saved configuration to the SLB.

admin config save

Syntax

```
cfokp"eqphki"ucxg">Eqphki"Pcog@"nqecvkqp">fghcwnv~hvr~uhvr~phu~ekhu~wud@"
]phufkt">PHU"Oqwpvgf"Fkt@_" ]wudrqtv"<u1>_
```

Description

Saves the current SLB configuration to a selected location.

admin config show**Syntax**

```
cfokp"eqphki"ujqy">fghcwnv~hvr~uhvr~phu~ekhu~wud@" ] phufkt">PHU"Oqwpvgf"  
Fkt@_" ] wudrqtv"<u1>]
```

Description

Lists the configurations saved to a location.

admin firmware bootbank**Syntax**

```
admin firmware bootbank <1|2>
```

Description

Sets the boot bank to be used at the next SLB reboot.

admin firmware copybank**Syntax**

```
admin firmware copybank
```

Description

Copies the boot bank from the currently booted bank to the alternate bank (for dual-boot SLBs).

admin firmware highrestimers**Syntax**

```
admin firmware highrestimers <enable|disable>
```

Description

Enables high resolution timers required for Performance Monitoring or disables high resolution timers (the default). Changing this setting requires a reboot in order for the change to take effect.

admin firmware show**Syntax**

```
admin firmware show [viewlog <enable|disable>]
```

Description

```
Nkuvu"vjg"ewttgpv"hktoyctg"tgxkukqp."vjg"dqqv"dcpm"uvcvwu"*hqt"fwcn/dqqv"
UNDu+."cpf"grvkqpcnn{"fkurnc{u"vjg"nqi"eqpvckpkpi"fgvcknu"cdqvw"hktoyctg"
wrfcvgu0
```

admin firmware update**Syntax**

```
admin firmware update <ftp|tftp|sftp|> file <Firmware File> key
<Checksum Key>
```

Description

Updates SLB firmware to a new revision.

You should be able to access the firmware file using the settings `admin ftp show displays`. The SLB branch office manager automatically reboots after successful update.

admin ftp password**Syntax**

```
cfokp"hvr"rcuuyqtf
```

Description

Sets the FTP server password and prevent it from being echoed.

admin ftp server**Syntax**

```
cfokp"hvr"ugtxgt">KR"Cfftguu"qt"Jquvpcog@"]nqikp">Wugt"Nqikp@_" ]rcvj"
>Fktgevqt{@_
```

Description

Sets the FTP/TFTP/SFTP server used for firmware updates and configuration save/restore.

The following list includes options which accept the CLEAR command:

Note: *CLEAR must be in all caps.*

```
admin ftp          login, path
```

admin ftp show**Syntax**

```
cfokp"hvr"ujqy
```

Description

Displays FTP settings.

admin keypad**Syntax**

```
cfokp"mg{rcf">nqem~wpnqem@
```

Description

Locks or unlocks the LCD keypad.

If the keypad is locked, you can scroll through settings but not change them.

admin keypad password**Syntax**

```
admin keypad password <Password>
Must be 6 digits.
```

Description

```
Ejcpigu"vjg"Tguvqtg"Hcevqt{"Fghcwnvu"rcuuyqtf"wugf"cv"vjg"NEF"vq"tgwtp"
vjg"UND"wpkv"vq"vjg"hcevqt{"ugvvkpiu0
```

admin keypad show**Syntax**

```
admin keypad show
```

Description

Displays keypad settings.

admin lcd reset**Syntax**

```
admin lcd reset
```

Description

Restarts the program that controls the LCD.

```
admin memory show
```

Syntax

```
admin memory show
```

Description

Displays information about SLB memory usage.

```
admin memory swap add <Size of Swap in MB> usbport <u1>
```

Syntax

```
admin memory swap add <Size of Swap in MB> usbport <u1>
```

Description

Creates a swap space from the SLB disk or an external storage device.

```
admin memory swap delete
```

Syntax

```
admin memory swap delete
```

Description

Deletes the swap space from the SLB disk or an external storage device.

```
admin quicksetup
```

Syntax

```
cfokp"swkemugvwr
```

Description

Runs the quick setup script.

admin reboot**Syntax**

```
admin reboot
```

Description

Reboots the SLB.

The front panel LCD displays the “Rebooting the SLB” message, and the normal boot sequence occurs.

admin shutdown**Syntax**

```
admin shutdown
```

Description

Prepares the SLB branch office manager to be powered off.

When you use this command to shut down the SLB, the LCD front panel displays the “Shutting down the SLB” message, followed by a pause, and then “Shutdown complete.” When “Shutdown complete” displays, it is safe to power off the SLB. This command is not available on the Web page.

admin site**Syntax**

Configures information about the site the SLB is located at:

```
admin site row <Data Center Rack Row Number>  
admin site cluster <Data Center Rack Group Number>  
admin site rack <Data Center Rack Number>  
admin site tag <Site Description>
```

```
admin site show
```

Description

Configures information about the site the where SLB unit is located.

admin version**Syntax**

```
admin version
```

Description

Displays current hardware and firmware information.

admin web certificate

Syntax

```
admin web certificate import via <sftp|scp> certfile <Certificate File>
                               privfile <Private Key File> host <IP Address or Name>
"#####"nqikp">Wugt"Nqikp@"]rcvj">Rcvj"vq"Hkngu@_
```

Description

Imports an SSL certificate.

admin web certificate reset

Syntax

```
admin web certificate reset
```

Description

Resets a web certificate and generates custom self-signed SSL certificate:

```
admin web certificate custom
```

admin web certificate show

Syntax

```
admin web certificate show
```

Description

Displays a web certificate.

admin web gadget

Syntax

```
admin web gadget <enable|disable>
```

Description

Enables or disables iGoogle Gadget web content.

admin web group**Syntax**

```
admin web group <Local or Remote Group Name>
```

Description

Configures the group that can access the web.admin web tlsv10

Syntax

```
admin web tlsv10 <enable|disable>
```

Description

Enables or disables TLS v1.0.

admin web tlsv11**Syntax**

```
admin web tlsv11 <enable|disable>
```

Description

Enables or disables TLS v1.1.

admin web timeout**Syntax**

```
admin web timeout <disable|5-120>
```

Description

Configures the timeout for web sessions.

admin web terminate**Syntax**

```
admin web terminate <Session ID>
```

Description

Terminates a web session.

admin web show**Syntax**

```
admin web show [viewcipherlist <enable|disable>]
                [viewslmsessions <enable|disable>]
```

Description

Displays current settings, with optional extra sessions or current ciphers.

admin web banner**Syntax**

```
admin web banner
```

Description

Configures the banner displayed on the web home page. `admin web iface <none,eth1,eth2,ppp>`

Syntax

```
admin web iface <none,eth1,eth2,ppp>
```

Description

Defines a list of network interfaces the web is available on.

admin web timeout <disable|5-120 minutes>**Syntax**

```
admin web timeout <disable|5-120 minutes>
```

Description

Configures the timeout for web sessions.

admin web cipher**Syntax**

```
admin web cipher <high|himed>
```

Description

Configures the strength of the cipher used by the web server (high is 256 or 128 bit, medium is 128 bit)

admin web sha2

Syntax

```
admin web sha2 <enable|disable>
```

Description

Enable using only SHA2 or higher ciphers

admin web server

Enables or disables running the web server (TCP ports 80 and 443):

```
admin web server <enable|disable>
```

admin web restart

Restart the web server:

```
admin web restart
```

The following list includes options which accept the CLEAR command:

Note: CLEAR *must be in all caps*.

```
admin web          group, banner
```

Audit Log Commands

show auditlog

Syntax

```
show auditlog [command|user|clear]
```

Description

Displays audit log. By default, shows the audit log sorted by date/time. You can sort it by user or command, or clear the audit log.

Authentication Commands

set auth

Syntax

```
set auth <one or more parameters>
```

Parameters

```
authusenextmethod <enable|disable>  
kerberos <1-6>  
ldap <1-6>  
localusers <1-6>  
pku">3/8@  
radius <1-6>  
tacacs+ <1-6>
```

Description

Sets ordering of authentication methods.

Local Users authentication is always the first method used. Any methods omitted from the command are disabled.

show auth

Syntax

```
show auth
```

Description

Displays authentication methods and their order of precedence.

show user

Syntax

```
show user
```

Description

Displays attributes of the currently logged in user.

ConsoleFlow Commands

Configure interaction with ConsoleFlow management server. The communication with the server is enabled by default, and can be disabled:

```
set cflow client <enable|disable>
```

Set interval between status updates, and firmware and configuration checks:

```
set cflow statusinterval <1-60 minutes> fwconfiginterval <1-72 hours>
```

Enable or disable firmware and configuration updates via ConsoleFlow:

```
set cflow fwupdate <enable|disable> configupdate <enable|disable>
```

Enable or disable reboots after firmware or configuration updates:

```
set cflow rebootafterupdate <enable|disable>
```

Set host and TCP port used for registration:

```
set cflow host <Registration Host> port <TCP Port>
```

Enable or disable using https for registration:

```
set cflow secureport <enable|disable>
```

Enable or disable validating certificates when using https:

```
set cflow validatecerts <enable|disable>
```

Enable or disable messaging services:

```
set cflow mqttstate <enable|disable>
```

Set host and TCP port used to for messaging:

```
set cflow mqttthost <Messaging Host> mqttport <TCP Port>
```

Enable or disable messaging security:

```
set cflow mqttsecurity <enable|disable>
```

Configure the device name and description used for registration:

```
set cflow devicename <Device Name> description <Device Description>
```

Configure the ConsoleFlow project tag used for registration:

```
set cflow projecttag <Project Tag>
```

Configure the timeout for ConsoleFlow Web Terminal sessions:

```
set cflow timeoutcli <1-1800 seconds>
```

```
set cflow timeoutdp <1-1800 seconds>
```

Configure the device port digital probe for determining managed device (MD) connection status:

```
set cflow digitalprobe <Device Port # or List or Name>
    frequency <disable|15-3600 seconds>
```

Set the device ID:

```
set cflow id
```

Set the device key:

```
set cflow key
```

Display settings and status:

```
show cflow
show cflow status
show cflow perform
show cflow scripts
show cflow probes
```

Kerberos Commands

set kerberos

Syntax

```
set kerberos <one or more parameters>
```

Parameters

```
accessoutlets <Outlet List>
clearports <Port List>
custommenu <Menu Name>
dataports <Port List>
breakseq <1-10 Chars>
escapeseq <1-10 Chars>
group <default|power|admin>
ipaddr <Key Distribution Center IP Address>
kdc <Key Distribution Center>
listenports <Port List>
permissions <Permission List>
```

Note: See [User Permissions Commands \(on page 278\)](#) for information on groups and user rights.

```
port <Key Distribution Center TCP Port>
realm <Kerberos Realm>
state <enable|disable>
useldapforlookup <enable|disable>
```

Description

Configures the SLB device to use Kerberos to authenticate users who log in via the Web, SSH, Telnet, or the console port.

The following list includes options which accept the CLEAR command:

Note: CLEAR *must be in all caps*.

```
set kerberos          realm, kdc, custommenu, escapeseq, breakseq,
                      dialbacknumber, accessoutlets, listenports,
                      dataports, clearports
```

show kerberos**Syntax**

```
ujqy"mgt dgtqu
```

Description

Displays Kerberos settings.

LDAP Commands**set ldap****Syntax**

```
set ldap <one or more parameters>
```

Set the LDAP bind password (any extra parameters will be ignored):

```
set ldap bindpassword
```

Parameters

```
state <enable|disable>
server <IP Address or Name>
port <TCP Port>
base <LDAP Base>
bindname <Bind Name>
bindwithlogin <enable|disable>
useldapschema <enable|disable>
adsupport <enable|disable>
filteruser <User Login Attribute>
filtergroup <Group Objectclass>
grmemberattr <Group Membership Attribute>
grmembervalue <dn|name>
encrypt <enable|disable>
dataports <Port List>
listenports <Port List>
clearports <Port List>
accessoutlets <Outlet List>
escapeseq <1-10 Chars>
breakseq <1-10 Chars>
custommenu <Menu Name>
allowdialback <enable|disable>
dialbacknumber <Phone Number>
group <default|power|admin>
permissions <Permission List>
Default is 389.
```

Note: See [User Permissions Commands \(on page 278\)](#) for information on groups and user rights.

Description

Configures the SLB branch office manager to use LDAP to authenticate users who log in via the Web, SSH, Telnet, or the console port.

The following list includes options which accept the CLEAR command:

Note: CLEAR *must be in all caps*.

```
set ldap          custommenu, escapeseq, breakseq, dialbacknumber,
                  base, bindname, bindpassword, filteruser,
                  filtergroup, grmemberattr, accessoutlets,
                  listenports, dataports, clearports
```

```
show ldap
```

Syntax

```
show ldap
```

Description

Displays LDAP settings:

Local Users Commands

```
set localusers add|edit
```

Syntax

```
set localusers add|edit <User Login> <one or more parameters>
```

Parameters

```
accessoutlets <Outlet List>
allowdialback <enable|disable>
breakseq <1-10 Chars>
changenextlogin <enable|disable>
changepassword <enable|disable>
clearports <Port List>
dataports <Port List>
dialbacknumber <Phone Number>
displaymenu <enable|disable>
escapeseq <1-10 Chars>
listenports <Port List>
ewuvqoogpw">Ogpw Name>
uid <User Identifier>
```

```
group <default|power|admin|Custom Group Name>  
passwordexpires <enable|disable>  
permissions <Permission List>
```

Note: See [User Permissions Commands \(on page 278\)](#) for information on groups and user rights.

Description

Configures local accounts (including sysadmin) who log in to the SLB unit by means of the Web, SSH, Telnet, or the console port.

```
set localusers allowreuse
```

Syntax

```
set localusers allowreuse <enable|disable>
```

Description

Sets whether a login password can be reused.

```
set localusers complexpasswords
```

Syntax

```
set localusers complexpasswords <enable|disable>
```

Description

Sets whether a complex login password is required.

```
set localusers state
```

Syntax

```
set localusers state <enable|disable>
```

Description

Enables or disables authentication of local users.

The following list includes options which accept the CLEAR command:

CLEAR must be in all caps.

```
set localusers      custommenu, escapeseq, breakseq, dialbacknumber,  
                    accessoutlets, listenports, dataports, clearports
```

set localusers delete**Syntax**

```
set localusers delete <User Login>
```

Description

Deletes a local user.

set localusers lifetime**Syntax**

```
set localusers lifetime <Number of Days>
```

Description

Sets the number of days the login password may be used. The default is 90 days.

set localusers maxloginattempts**Syntax**

```
set localusers maxloginattempts <Number of Logins>
```

Description

Sets the maximum number of login attempts before the account is locked. Disabled by default.

set localusers password**Syntax**

```
set localusers password <User Login>
```

Description

Sets a login password for the local user.

set localusers periodlockout**Syntax**

```
set localusers periodlockout <Number of Minutes>
```

Description

Sets the number of minutes after a lockout before the user can try to log in again. Disabled by default.

```
set localusers periodwarning
```

Syntax

```
set localusers periodwarning <Number of Days>
```

Description

Sets the number of days the system warns the user that the password will be expiring. The default is 7 days.

```
set localusers reusehistory
```

Syntax

```
set localusers reusehistory <Number of Passwords>
```

Description

Ugvu"vhe number of passwords the user must use before reusing an old password. The default is 4.

```
set localusers state
```

Syntax

```
set localusers state <enable|disable>
```

Description

Enables or disables authentication of local users.

```
show localusers
```

Syntax

```
show localusers [user <User Login>]
```

Description

Displays local users.

NIS Commands

```
set nis
```

Syntax

```
set nis <one or more parameters>
```

Parameters

```
accessoutlets <Outlet List>
broadcast <enable|disable>
clearports <Port List>
custommenu <Menu Name>
dataports <Port List>
domain <NIS Domain Name>
breakseq <1-10 Chars>
escapeseq <1-10 Chars>
group <default|power|admin>
listenports <Port List>
master <IP Address or Hostname>
permissions <Permission List>
```

Note: See *User Permissions Commands* on page 278 for information on groups and user rights.

```
slave1 <IP Address or Hostname>
slave2 <IP Address or Hostname>
slave3 <IP Address or Hostname>
slave4 <IP Address or Hostname>
slave5 <IP Address or Hostname>
state <enable|disable>
```

Description

Configures the SLB branch office manager to use NIS to authenticate users who log in via the Web, SSH, Telnet, or the console port.

The following list includes options which accept the CLEAR command:

Note: CLEAR *must be in all caps*.

```
set nis          custommenu, escapeseq, breakseq, dialbacknumber,
                 domain, accessoutlets, listenports, dataports,
                 clearports
```

```
show nis
```

Syntax

```
ujqy"pku
```

Description

```
Fkurnc{u"PKU"ugvvkpiu0
```

RADIUS Commands

```
set radius
```

Syntax

```
set radius <one or more parameters>
```

Parameters:

```
accessoutlets <Outlet List>
state <enable|disable>
clearports <Port List>
custommenu <Menu Name>
dataports <Port List>
breakseq <1-10 Chars>
escapeseq <1-10 Chars>
group <default|power|admin>
listenports <Port List>
permissions <Permission List>
```

Note: See *User Permissions Commands* on page 278 for information on groups and user rights.

```
timeout <enable|1-30>
```

Note: Sets the number of seconds after which the connection attempt times out. It may be 1-30 seconds.

Description

Configures the SLB branch office manager to use RADIUS to authenticate users who log in via the Web, SSH, Telnet, or the console port.

```
set radius server
```

Syntax

```
set radius server <1|2> host <IP Address or Hostname> secret <Secret>
[port <TCP Port>]
```

Description

Identifies the RADIUS server(s), the text secret, and the number of the TCP port on the RADIUS server.

Note: The default port is 1812.

The following list includes options which accept the CLEAR command:

Note: CLEAR *must be in all caps*.

```
set radius          custommenu, escapeseq, breakseq, dialbacknumber,
                   secret, accessoutlets, listenports, dataports,
                   clearports
```

show radius

Syntax

```
show radius
```

Description

```
Fkurnc{u"TCFKWU"ugvvkpiu0
```

TACACS+ Commands

set tacacs+

Syntax

```
set tacacs+ <one or more parameters>
```

Parameters

```
accessoutlets <Outlet List>
allowdialback <enable|disable>
authservice <login|pap|chap>
breakseq <1-10 Chars>
clearports <Port List>
custommenu <Menu Name>
dataports <Port List>
dialbacknumber <Phone Number>
encrypt <enable|disable>
escapeseq <1-10 Chars>
group <default|power|admin>
listenports <Port List>
permissions <Permission List>
protocol <Protocol for Service>
server1 <IP Address or Name>
server2 <IP Address or Name>
server3 <IP Address or Name>
service <Service to Authorize>
state <enable|disable>
```

Note: See [User Permissions Commands \(on page 278\)](#) for information on groups and user rights.

Set the TACACS+ secret (any extra parameters will be ignored):

```
set tacacs+ secret
show tacacs+
```

Description

Configures the SLB unit to use TACACS+ to authenticate users who log in via the Web, SSH, Telnet, or the console port.

The following list includes options which accept the CLEAR command:

Note: CLEAR *must be in all caps*.

```
set tacacs+          custommenu, escapeseq, breakseq, dialbacknumber,
                    secret, accessoutlets, listenports, dataports,
                    clearports
```

```
show tacacs+
```

Syntax

```
ujqy"vceceu-
```

Description

Displays TACACS+ settings.

User Permissions Commands

```
set localusers group
```

Syntax

```
set localusers add|edit <user> group <default|power|admin>
```

Description

Adds a local user to a user group or changes the group the user belongs to.

```
set localusers lock
```

Syntax

```
set localusers unlock <User Login>
```

Description

Blocks (locks) a user's ability to login.

```
set localusers unlock
```

Syntax

```
set localusers unlock <User Login>
```

Description

Allows (unlocks) a user's ability to login.

```
set localusers permissions
```

Syntax

```
set localusers add|edit <user> permissions <Permission List>
```

where

<Permission List> is one or more of nt, sv, dt, lu, ra, sk, um, dp, do, ub, dp, do, ub, rs, rc, dr, wb, sn, ad, po

To remove a permission, type a minus sign before the two-letter abbreviation for a user permission.

Description

Sets a local user's permissions (not defined by the user group).

```
set remoteusers add|edit
```

Syntax

```
set remoteusers add|edit <User Login> [<parameters>]
```

Parameters

```
accessoutlets <Outlet List>
dataports <Port List>
breakseq <1-10 Chars>
escapeseq <1-10 Chars>
listenports <Port List>
clearports <Port List>
group <default|power|admin|Custom Group Name>
permissions <Permissions List>
```

where

<Permission List> is one or more of nt, sv, dt, lu, ra, sk, um, dp, do, ub, rs, rc, dr, wb, sn, ad, po

To remove a permission, type a minus sign before the two-letter abbreviation for a user right.

Description

Sets attributes for users who log in by a remote authentication method.

```
set remoteusers listonlyauth
```

Syntax

```
set remoteusers listonlyauth <enable|disable>
```

Description

Sets whether remote users who are not part of the remote user list will be authenticated.

```
set remoteusers delete
```

Syntax

```
set remoteusers delete <User Login>
```

Description

Removes a remote user.

```
show remoteusers
```

Syntax

```
show remoteusers
```

Description

Displays settings for all remote users

The following list includes options which accept the CLEAR command:

Note: CLEAR *must be in all caps*.

```
set remoteusers      custommenu, escapeseq, breakseq, dialbacknumber,  
                    accessoutlets, listenports, dataports, clearports
```

```
set <nis|ldap|radius|kerberos|tacacs+> group
```

Syntax

```
set <nis|ldap|radius|kerberos|tacacs> group <default|power|admin>
```

Description

Sets a permission group for remotely authorized users.

```
set <nis|ldap|radius|kerberos|tacacs+> permissions
```

Syntax

```
set <nis|ldap|radius|kerberos|tacacs> permissions <Permission List>
```

where

<Permission List> is one or more of nt, sv, dt, lu, ra, sk, um, dp, do, ub, rs, rc, dr, wb, sn, ad, po

Description

Sets permissions not already defined by the assigned permissions group.

```
show user
```

Syntax

```
show user
```

Description

Displays the rights of the currently logged-in user:

CLI Commands

```
set cli
```

Syntax

```
set cli scscommands <enable|disable>
```

Description

Allows you to use SCS-compatible commands as shortcuts for executing commands. Enabling this feature enables it only for the current cli session. It is disabled by default.

Note: Settings are retained between CLI sessions for local users and users listed in the remote users list.

set cli terminallines

Syntax

```
set cli terminallines <disable|Number of lines>
```

Description

Sets the number of lines in the terminal emulation (screen) for paging through text one screenful at a time, if the SLB device cannot detect the size of the terminal automatically.

Note: Settings are retained between CLI sessions for local users and users listed in the remote users list.

set localusers lock

Syntax

```
set localusers lock <User Login>
```

Description

Block (lock out) a user's ability to log in.

set localusers unlock

Syntax

```
set localusers unlock <User Login>
```

Description

Allow (unlock) a user's ability to log in.

show cli

Syntax

```
show cli
```

Description

Displays current CLI settings.

show user

Syntax

```
show user
```

Description

Displays attributes of the currently logged in user.

```
set history
```

Syntax

```
set history clear
```

Description

Clears the commands that have been entered during the command line interface session.

```
show history
```

Syntax

```
show history
```

Description

Displays the last 100 commands entered during the session.

Connection Commands

```
connect bidirection
```

Syntax

```
connect bidirection <Port # or Name> <endpoint> <one or more Parameters>
```

Parameters

Endpoint is one of:

```
charcount <# of Chars>
```

```
charseq <Char Sequence>
```

```
charxfer <toendpoint|fromendpoint>
```

```
date <MMDDYYhhmm[ss]>
```

```
deviceport <Device Port # or Name>
```

```
exclusive <enable|disable>
```

```
ssh <IP Address or Name> [port <TCP Port>] [<SSH flags>]
```

where <SSH flags> is one or more of:

```
user <Login Name>
```

```
version <1|2>
```

```
command <Command to Execute>
```

```
ver">KR"Cfftguu@"] rqtv">VER"Rqtv@_
```

```
telnet <IP Address or Name> [port <TCP Port>]
trigger <now|datetime|chars>
```

If the trigger is `datetime` (establish connection at a specified date/time), enter the `date` parameter. If the trigger is `chars` (establish connection on receipt of a specified number or characters or a character sequence), enter the `charxfer` parameter and either the `charcount` or the `charseq` parameter.

```
udp <IP Address> [port <UDP Port>]
```

Description

Connects a device port to another device port or an outbound network connection (data flows in both directions).

connect direct

Syntax

```
eqppgev"fktgev">gpfrqkpv@
```

Parameters

Endpoint is one of:

```
deviceport <Device Port # or Name>
ssh <IP Address or Name> [port <TCP Port>] [<SSH flags>]
```

where <SSH flags> is one or more of:

```
user <Login Name>
version <1|2>
command <Command to Execute>
```

```
tcp <IP Address> [port <TCP Port>]
telnet <IP Address or Name> [port <TCP Port>]
udp <IP Address> [port <UDP Port>]
```

Description

Connects to a device port to monitor and/or interact with it, or establishes an outbound network connection.

connect global outgoingtimeout

Syntax

```
connect global outgoingtimeout <disable|1-9999 seconds>
```

Description

Sets the amount of time the SLB branch office manager will wait for a response (sign of life) from an SSH/Telnet server that it is trying to connect to.

Note: *This is not a TCP timeout.*

connect listen deviceport**Syntax**

```
connect listen deviceport <Device Port # or Name>
```

Description

Monitors a device port.

connect terminate**Syntax**

```
connect terminate <Connection ID>
```

Description

Terminates a bidirectional or unidirectional connection.

connect unidirection**Syntax**

```
eqpppgev"wpkfktgevkqp">Fgxkeg"Rqtv"%qt"Pcog@"fcvchnqy"
>vqgpfrrqkpv|htqogpfrrqkpv@">gpfrqkpv@
```

Parameters

Endpoint is one of:

charcount <# of Chars>

charseq <Char Sequence>

datetime <MMDDYYhhmm[ss]>

deviceport <Port # or Name>

exclusive <enable|disable>

ssh <IP Address or Name> [port <TCP Port>] [<SSH flags>]

where <SSH flags> is one or more of:

user <Login Name>

version <1|2>

command <Command to Execute>

tcp <IP Address> [port <TCP Port>]

telnet <IP Address or Name> [port <TCP Port>]

trigger <now|datetime|chars>

If the trigger is `datetime` (establish connection at a specified date/time), enter the date parameter. If the trigger is `chars` (establish connection on receipt of a specified number or characters or a character sequence), enter either the `charcount` or the `charseq` parameter.

udp <IP Address> [port <UDP Port>]

Description

Connects a device port to another device port or an outbound network connection (data flows in one direction).

```
show connections
```

Syntax

```
show connections [email <Email Address>]
```

Description

Displays connections and their IDs. You can optionally email the displayed information.

The connection IDs are in the left column of the resulting table. The connection ID associated with a particular connection may change if the connection times out and is restarted.

```
show connections connid
```

Syntax

```
ujqy"eqppgevkqpu"eqppkf">Eqppgevkqp"KF@" ] gockn">Gockn"Cfftguu@_
```

Description

Displays details for a single connection. You can optionally email the displayed information.

Console Port Commands

```
set consoleport
```

Syntax

```
set consoleport <one or more parameters>
```

Parameters

```
baud <300-115200>
databits <7|8>
flowcontrol <none|xon/xoff|rts/cts>
group <Local or Remote Group Name>
parity <none|odd|even>
showlines <enable|disable>
stopbits <1|2>
timeout <disable|1-30>
```

Description

Configures console port settings.

```
show consoleport
```

Syntax

```
show consoleport
```

Description

Displays console port settings.

The following list includes options which accept the CLEAR command:

Note: CLEAR *must be in all caps*.

```
console port          group
```

Custom User Menu Commands

When creating a custom user menu, note the following limitations:

- ◆ Maximum of 20 custom user menus.
- ◆ Maximum of 50 commands per custom user menu (logout is always the last command).
- ◆ Maximum of 15 characters for menu names.
- ◆ Maximum of five nested menus can be called.
- ◆ No syntax checking. (Enter each command correctly.)

```
set localusers
```

Syntax

```
set localusers add|edit <User Login> menu <Menu Name>
```

Description

Assigns a custom user menu to a local user.

```
set menu add
```

Syntax

```
set menu add <Menu Name> [command <Command Number>]
```

Description

Creates a new custom user menu or adds a command to an existing custom user menu.

```
set menu edit
```

Syntax

```
set menu edit <Menu Name> <parameter>
```

Parameters

```
command <Command Number>
nickname <Command Number>
tgfkurnc{ogpw">gpcdng~fkucdng@
shownicknames <enable|disable>
title <Menu Title>
```

Description

Changes a command within an existing custom user menu.

Changes a nickname within an existing custom user menu.

Enables or disables the redisplay of the menu before each prompt.

Enables or disables the display of command nicknames instead of commands.

Sets the optional title for a menu.

```
set menu delete
```

Syntax

```
set menu delete <Menu Name> [command <Command Number>]
```

Description

Deletes a custom user menu or one command within a custom user menu.

The following list includes options which accept the CLEAR command:

Note: CLEAR *must be in all caps*.

```
set menu edit          nickname
```

```
set <nis|ldap|radius|kerberos|tacacs+> custommenu
```

Syntax

```
set <nis|ldap|radius|kerberos|tacacs> custommenu <Menu Name>
```

Description

Sets a default custom menu for remotely authorized users.

```
show menu
```

Syntax

```
show menu <all|Menu Name>
```

Description

Displays a list of all menu names or all commands for a specific menu.

Date and Time Commands

```
set datetime
```

Syntax

```
set datetime <one date/time parameter>
```

Parameters

```
date <MMDDYYhhmm[ss]>  
timezone <Time Zone>
```

Note: If you type an invalid time zone, the system guides you through the process of selecting a time zone.

Description

Sets the local date, time, and local time zone (one parameter at a time).

```
show datetime
```

Syntax

```
show datetime
```

Description

Displays the local date, time, and time zone.

set ntp**Syntax**

```
set ntp <one or more ntp parameters>
```

Parameters

```
localserver1 <IP Address or Hostname>
localserver2 <IP Address or Hostname>
localserver3 <IP Address or Hostname>
poll <local|public>
publicserver <IP Address or Hostname>
state <enable|disable>
sync <broadcast|poll>
```

Description

Synchronizes the SLB branch office manager with a remote time server using NTP.

show ntp**Syntax**

```
show ntp
```

Description

Displays NTP settings.

Device Commands

set command**Syntax**

```
set command <Device Port # or Name or List> <one or more parameters>
```

Parameters

```
slp auth login <User Login>
```

Establishes the authentication information to log into the SLP power manager attached to the device port.

```
slp restart
```

Issues the CLI command the SLP device uses to restart itself.

```
slp outletcontrol state <on|off|cyclepower> [outlet <Outlet #>] [tower <A|B>]
```

Outlet # is 1-8 for SLP8 and 1-16 for SLP16 units.

The `outletcontrol` parameters control individual outlets.

```
slp outletstate [outlet <Outlet #>]
```

The `outletstate` parameter shows the state of all outlets or a single outlet.

```
slp envmon
```

Displays the environmental status (e.g., temperature and humidity) of the SLP power manager.

```
slp infeedstatus
```

Displays the infeed status and load of the SLP unit.

```
slp system
```

Provides system information for the SLP power manager.

```
sensorsoft lowtemp <Low Temperature in C.>
```

Sets the lowest temperature permitted for the port.

```
sensorsoft hightemp <High Temperature in C.>
```

Sets the highest temperature permitted for the port.

```
sensorsoft lowhumidity <Low Humidity %>
```

Sets the lowest humidity permitted for the port.

```
sensorsoft highhumidity <High Humidity %>
```

Sets the lowest humidity permitted for the port.

```
sensorsoft traps <enable|disable>
```

Enables or disables traps when specified conditions are met.

```
sensorsoft status
```

Displays the status of the port.

Description

Sends commands to (or control) a device connected to an SLB device port over the serial port.

Note: *Currently the only devices supported for this type of interaction are the SLP power manager and Sensorsoft devices.*

Device Port Commands

```
set deviceport port
```

Syntax

```
ugv"fgxkegrqtv"rqtv"<Device Port # or List or Name> <one or more parameters>
```

Example

```
set deviceport port 2-5,6,12,15-16 baud 2400 locallogging enable
```

Parameters

```
auth <pap|chap>
banner <Banner Text>
baud <300-230400>
breakseq <1-10 Chars>
calleridcmd <Modem Command String>
calleridlogging <enable|disable>
cbcpnocallback <enable|disable>
cbcptype <admin|user>
chapauth <chaphost|localusers>
chaphost <CHAP Host or User Name>
```

The user defines the secret.

```
checkdsr <enable|disable>
closedsr <enable|disable>
databits <7|8>
device <none|slp8|slp16slp8|exp8|slp8exp16|exp8|slp8exp16|slp16exp8
      |slp16exp16|sensorsoft|servertech>
dialback+ondemand|cbcpclient|cbcpserver>
dialbackdelay <PPP Dial-back Delay>
dialbacknumber <username|Phone Number>
dialbackretries <1-10>
dialinhostlist|dialondemand|dialin+ondemand|
dialinlist <Host List for Dial-in>
dialoutnumber <Phone Number>
dialoutlogin <Remote User Login>
dialbacknumber <username|Phone Number>
dodauth <pap|chap>
dodchaphost <CHAP Host or User Name>
emaildelay <Email Delay>
emaillogging <disable|bytecnt|charstr>
emailrestart <Restart Delay>
emailsend <email|trap|both>
emailstring <Regex String>
emailsubj <Email Subject>
emailthreshold <Threshold>
emailto <Email Address>
flowcontrol <none|xon/xoff|rts/cts>
group <Local or Remote Group Name>
idletimeout <disable|1-9999 seconds>
ipaddr <IP Address>
initscript <Initialization Script>
```

A script that initializes a modem.

```
localipaddr <negotiate|IP Address>
locallogging <enable|disable>
logins <enable|disable>
maxdirect <1-10>
maxdirect <1-10>
```

```

modemmode <text|ppp>
modemstate <disable|dialout|dialin|dialback|dialondemand|
dialin+dialondemand|dialinhostlist>
modemtimeout <disable|1-9999 seconds>
name <Device Port Name>
nat <enable|disable>
nfsdir <Logging Directory>
nfslogging <enable|disable>
nfsmaxfiles <Max # of Files>
nfsmaxsize <Size in Bytes>
parity <none|odd|even>
portlogseq <1-10 Chars>
remoteipaddr <negotiate|IP Address>
restartdelay <PPP Restart Delay>
showlines <enable|disable>
slmlogging <enable|disable>
slmms <NMS IP Address>
slmthreshold <Threshold>
slmtime <Time Frame>
sshauth <enable|disable>
sshin <enable|disable>
sshport <TCP Port>
sstimeout <disable|1-1800 seconds>
stopbits <1|2>
sysloglogging <enable|disable>
tcpauth <enable|disable>
tcpin <enable|disable>
tcpport <TCP Port>
tcptimeout <disable|1-1800 seconds>
telnetauth <enable|disable>
telnetin <enable|disable>
telnetport <TCP Port>
telnettimeout <disable|1-1800 sec>
timeoutlogins <disable or 1-30>
usblogging <enable|disable>
usbmaxfiles <Max # of Files>
usbmaxsize <Size in Bytes>
usbport <U1>
usesites <enable|disable>
viewportlog <enable|disable>

```

Description

Configures a single port or a group of ports.

```
set deviceport global
```

Syntax

```
set deviceport global <one or more parameters>
```

Parameters

```

uujrqtv">VER"Rqtv@
telnetport <TCP Port>
tcpport <TCP Port>
maxdirect <1-10>

```

Description

Configures settings for all or a group of device ports.

The following list includes options which accept the CLEAR command:

Note: CLEAR *must be in all caps*.

```

set deviceport          dialinlist, nfsdir, nfsdir, breakseq, banner,
                        group, portlogseq, chaphost, chapsecret,
                        dodchaphost, dodchapsecret, initscript,
                        dialoutlogin, dialbacknumber, emailsubj,
                        emailstring, emailto

```

```
show deviceport global
```

Syntax

```
show deviceport global
```

Description

Displays global settings for device ports.

```
show deviceport names
```

Syntax

```
ujqy"fgxkegrqtv"pcogu
```

Description

Displays a list of all device port names.

```
show deviceport port
```

Syntax

```
show deviceport port <Device Port List or Name>
```

Description

Displays the settings for one or more device ports.

show portcounters**Syntax**

```
show portcounters [deviceport <Device Port List or Name>] [email <Email Address>]
```

Description

Displays device port statistics and errors for one or more ports. You can optionally email the displayed information.

show portcounters zerocounters**Syntax**

```
show portcounters zerocounters <Device Port List or Name>
```

Description

Zeros the port counters for one or more device ports.

show portstatus**Syntax**

```
show portstatus [deviceport <Device Port List or Name>] [email <Email Address>]
```

Description

Displays the modes and states of one or more device port(s). You can optionally email the displayed information.

Diagnostic Commands

diag arp**Syntax**

```
fkci "ctr"] gockn">Gockn"Cfftguu@_
```

Description

Displays the ARP table of IP address-to-hardware address mapping. You can optionally email the displayed information.

diag internals**Syntax**

```
diag internals
```

Description

Displays information on the internal memory, storage and processes of the SLB

Note: *This command is available in the CLI but not the web.*

diag netstat**Syntax**

```
diag netstat [protocol <all|tcp|udp>] [email <Email Address>]
```

Description

To display a report of network connections. You can optionally email the displayed information.

diag nettrace**Syntax**

```
diag nettrace <one or more parameters>
```

Parameters

```
ethport <1|2>  
protocol <tcp|udp|icmp|esp>  
host <IP Address or Name>  
numpackets <Number of Packets>  
verbose <low|medium|high|disable>  
pcapfile <File Name>  
usbport <U1>
```

Description

Displays all network traffic, applying optional filters. This command is not available on the web page.

diag lookup**Syntax**

```
fkci"nqqmwr">Jquvpcog@"]gockn">Email Address@_
```

Description

Resolves a host name into an IP address. You can optionally email the displayed information.

diag loopback

Syntax

```
fkci "nqqrdcem" > Fgxkeg "Rqtv" Pwodgt "qt" Pcog@ [<parameters>]
```

Parameters

```
test <internal|external>
xferdatasize <Size In Kbytes to Transfer>
Default is 1 Kbyte.
```

Description

Tests a device port by transmitting data out the port and verifying that it is received correctly.

A special loopback cable comes with the SLB. To test a device port, plug the cable into the device port and run this command. The command sends the specified Kbytes to the device port and reports success or failure. The test is performed at 9600 baud. Only an external test requires a loopback cable.

Top Command Synopsis

he diag top

Syntax

```
he diag top
```

Description

Displays CPU usage, memory usage and tasks: diag top [<parameters>]

Parameters

```
continuous <enable|disable>
count <Number of Iterations to Display>
delay <Delay in Seconds>
numlines <Number of Lines to Display>
```

Defaults:

```
count=1, delay = 5 seconds
```

diag traceroute**Syntax**

```
fkci "vtcegtqwvg" >KR "Cfftguu" qt "Jquvpcog@"
```

Description

Displays the route that packets take to get to a network host.

End Device Commands

set command**Syntax**

```
set command <Device Port # or Name or List> <one or more parameters>
```

Parameters

```
unr "cwvj "nqikp" >Wugt "Nqikp@"
```

Establishes the authentication information to log into the SLP power manager attached to the device port.

```
slp envmon
```

Displays the environmental status (e.g., temperature and humidity) of the SLP.

```
unr "qvwngveqpvtqn "uvvcvg" >qp~qhh~e { engrqygt@" ] qvwngv" >Qvwngv" %@_
```

Outlet # is 1-8 for SLP8 and 1-16 for SLP16. The `outletcontrol` parameters control individual outlets.

```
unr "qvwngvuvvcvg" ] qvwngv" >Qvwngv" %@_
```

Shows the state of all outlets or a single outlet.

```
unr "tguvctv
```

Issues the CLI command the SLP uses to restart itself.

```
slp system
```

Displays system information for the SLP.

Description

Sends commands to (or controls) a device connected to an SLB device port over the serial port. Currently the only type of device supported for this type of interaction is the SLP device.

Events Commands

admin events add

Syntax

admin events add <trigger> <response>

<trigger> is one of:

receivetrap, templimit, humidlimit, overcurrent, inletstatus,
nomodemdial, or dpdatadrop.

<response> is one of:

action <fwdalltrapseth|fwdseltrapeth> ethport <1|2> nms <SNMP NMS>
community <SNMP Community> [oid <SNMP OID>]

action <fwdalltrapsmodem|fwdseltrapmodem> deviceport <Device Port #
or Name> nms <SNMP NMS> community <SNMP Community> [oid <SNMP Trap
OID>]

action <fwdalltrapsmodem|fwdseltrapmodem> wudrqtv nms <SNMP NMS>
community <SNMP Community> [oid <SNMP Trap OID>]

action <syslog>

Description

Defines events.

admin events delete

Syntax

cfokp"gxgpvu"fgngvg">Gxgpv"KF@

Description

Deletes an event definition.

admin events edit

Syntax

admin events edit <Event ID> <parameters>

Parameters

community <SNMP Community>
deviceport <Device Port # or Name>
ethport <1|2>
nms <SNMP NMS>

```
oid <SNMP Trap OID>  
wudrqtv <ul>
```

Description

Edits event definitions.

```
admin events show
```

Syntax

```
admin events show
```

Description

Displays event definitions.

Global Commands

```
set deviceport global
```

Syntax

```
set deviceport global <one or more parameters>
```

Parameters

```
sshport <TCP Port>  
tcpport <TCP Port>  
telnetport <TCP Port>
```

Port is a port number between 1025 and 65528.

To view global settings for device ports:

```
show deviceport global
```

Description

Configures settings for all or a group of device ports.

Group Commands

set groups

Syntax

```
set groups add|edit <Group Name> [<parameters>]
```

Parameters

```
dataports <Port List>
  listenports <Port List>
  clearports <Port List>
  accessoutlets <Outlet List>
  escapeseq <1-10 Chars>
  breakseq <1-10 Chars>
  custommenu <Menu Name>
  displaymenu <enable|disable>
  allowdialback <enable|disable>
  dialbacknumber <Phone Number>
  permissions <Permission List>
```

Note: See 'help user permissions' for information on user rights.

Rename a group:

```
set groups rename <Group Name> newname <New Group Name>
```

Delete a group:

```
set groups delete <Group Name>
show groups [name <Group Name>] members <enable|disable>
```

The following list includes options which accept the CLEAR command:

Note: CLEAR *must be in all caps*.

```
set groups          custommenu, escapeseq, breakseq, dialbacknumber,
                   outletlist, listenports, dataports, clearports
```

Host List Commands

```
set hostlist add|edit <Host List Name>"
```

Syntax

```
set hostlist add|edit <Host List Name> [<parameters>]
```

Parameters

name <Host List Name> (edit only)

retrycount <1-10>

Default is 3.

auth <enable|disable>

Description

Configures a prioritized list of hosts to be used for modem dial-in connections.

```
set hostlist add|edit <Host List Name>"entry
```

Syntax

```
ugv"jqvvnkuv"cff~gfkv">Jquv"Nkuv"Pcog@"gpvt { ">Jquv"Pwodgt@"
]>rctcogvgtu@_
```

Parameters

jqv">KR"Cfftguu"qt"Pcog@

rtqvqeqn">uuj~vgnpgv~ver@

rqtv">VER"Rqtv@

guecrgugs">3/32"Ejctu@

Description

Adds a new host entry to a list or edit an existing entry.

```
set hostlist edit <Host List Name> move
```

Syntax

```
set hostlist edit <Host List Name> move <Host Number> position <Host
Number>
```

Description

Moves a host entry to a new position in the host list.

```
set hostlist delete
```

Syntax

```
set hostlist delete <Host List> [entry <Host Number>]
```

Description

Deletes a host list, or a single host entry from a host list.

```
show hostlist
```

Syntax

```
show hostlist <all|names|Host List Name>
```

Description

Displays the members of a host list.

IP Filter Commands

```
set ipfilter state
```

Syntax

```
set ipfilter state
```

Description

Enables or disables IP filtering for incoming network traffic.

```
set ipfilter mapping
```

Syntax

```
set ipfilter mapping <parameters>
```

Parameters

```
ethernet <1|2> state <disable>
ethernet <1|2> state <enable> ruleset <Ruleset Name>
deviceport <1..48> state <disable>
deviceport <1..48> state <enable> ruleset <Ruleset Name>
wudrqtv <u1> state <disable>
wudrqtv">u1@"uvcvg">gpcdng@"twngugv">Twngugv"Pame>
```

Description

Maps an IP filter to an interface.

```
set ip filter rules
```

Syntax

```
set ipfilter rules <parameters>
```

Parameters

```
add <Ruleset Name>
delete <Ruleset Name>
edit <Ruleset Name> <Edit Parameters>
```

Edit Parameters:

```
    append
    insert <Rule Number>
    replace <Rule Number>
delete <Rule Number>
```

Description

Sets IP filter rules.

Logging Commands

```
set deviceport port
```

Syntax

```
set deviceport port <Device Port List or Name> <one or more deviceport parameters>
```

Parameters

```
emaildelay <Email Delay>
emaillogging <disable|bytecnt|charstr>
emailrestart <Restart Delay>
emailsend <email|trap|both>
emailstring <Regex String>
emailsubj <Email Subject>
emailthreshold <Byte Threshold>
emailto <Email Address>
filedir <Logging Directory>
filelogging <enable|disable>
filemaxfiles <Max # of Files>
```



```

filemaxsize <Max Size of Files>
locallogging <enable|disable>
name <Device Port Name>
nfsdir <Logging Directory>
nfslogging <enable|disable>
nfsmaxfiles <Max # of Files>
nfsmaxsize <Size in Bytes>
usblogging <enable|disable>
usbmaxfiles <Max # of Files>
usbmaxsize <Size in Bytes>
wudrqtv <ul>
u{unqinqiikpi">gpcdng~fkucdng>

```

Description

Configures logging settings for one or more device ports.

Local logging must be enabled for a device port for the `locallog` commands to be executed. To use the `set locallog clear` command, the user must have permission to clear port buffers (see [Chapter 11: User Authentication](#)).

Example

```
set deviceport port 2-5,6,12,15-16 baud 2400 locallogging enable
```

```
show locallog
```

Syntax

```
show locallog <Device Port # or Name> [bytes <Bytes To Display>]
```

Description

```
Fkurnc{u"c"urgekhke"pwodgt"qh"d{vgu"qh"fcvc"hqt"c"fgxkeg"rqtv0"3M"ku"vjg"
fghcwnv0
```

```
set locallog clear
```

Syntax

```
set locallog clear <Device Port # or Name>
```

Description

Clears the local log for a device port.

The `locallog` commands can only be executed for a device port if local logging is enabled for the port. The `set locallog clear` command can only be executed if the user has permission to clear port buffers (see [Chapter 11: User Authentication](#)).

```
set log clear modem
```

Syntax

```
set log clear modem
```

Description

Clear the modem log (the modem log is automatically pruned when it reaches 50K).

```
set log modem ppplog
```

Syntax

```
set log modem ppplog <enable|disable>
```

Description

Enables PPP activity messages in the modem log.

```
set log modem pppdebug
```

Syntax

```
set log modem pppdebug <enable|disable>
```

Description

Enables PPP debugging messages in the modem log:

```
show log modem
```

Syntax

```
show log modem [display <head|tail>] [numlines <Number of Lines>]
```

Description

View the modem activity log for external modems and USB modems:

```
show log local
```

Syntax

```
show log local|nfs|usb <Device Port # or Name> [<parameters>]
```

Parameters

```
display <head|tail>
```

```

numlines <Number of Lines>
bytes <Bytes to Display>
startbyte <Byte Index>
logfile <NFS or USB Log File>

```

Defaults: bytes=1000, startbyte=1, numlines=40

Description

View the log for local, NFS or USB logging (NFS and USB use the current logging settings for the Device Port). Default is to show the tail of the log:

```
show log files
```

Syntax

```

show log files nfs|usb [localdir <NFS Mount Local Directory>]
[usbport <ul>]
[deviceport <Device Port # or name>]

```

Description

Lists the NFS or USB log files, either for a specific device port, or all log files in a USB, or NFSlocation:

Network Commands

```
set network
```

Syntax

```
set network <parameters>
```

Parameters

```

interval <1-99999 Seconds>
ipforwarding <enable|disable>
probes <Number of Probes>
startprobes <1-99999 Seconds>

```

Description

Sets TCP Keepalive and IP Forwarding network parameters.

```
set network dns
```

Syntax

```
set network dns <1|2|3> ipaddr <IP Address>
```

Description

Eqphkiwtgu"wr"vq"vjtgg"FPU"ugtxgtu0

set network gateway**Syntax**

set network gateway <parameters>

Parameters

default <IP Address>
 precedence <dhcp|gprs|default>
 failover <IP Address>
 pingip <IP Address>
 ethport <1|2>
 pingdelay <1-250 seconds>
 failedpings <1-250>

faildevice <none|hspa|sierra>
 faildevapn <Fail-over Device: APN of Mobile Carrier>
 faildevlockpin <enable|disable>
 faildevlogin <Fail-over Device: Admin login>

Transfer firmware update files to the SLB to initiate a firmware update on the fail-over device:

```
set network gateway faildevupdate <ftp|sftp|scp|usb>
  gwfile <Firmware File> radiofile <Radio File>
  [host <IP Address or Name>] [login <User login>] [path <File Path>]
```

Reboot the fail-over device, or set the fail-over device SIM Card PIN #, SIM Personal Unblocking Key or Admin Password (any extra parameters are ignored):

```
set network gateway reboot
set network gateway faildevpin
set network gateway faildevpuk
set network gateway faildevpassword
```

Description

Set default and fail-over gateways (the fail-over gateway is used if an IP address usually accessible through the default gateway fails to return one or more pings), and configure settings for supported fail-over devices.

set network host**Syntax**

set network host <Hostname> [domain <Domain Name>]

Description

Sets the SLB host name and domain name.

```
set network port
```

Syntax

```
set network port <1|2> <parameters>
```

Parameters

```
mode <auto|10mbit-half|100mbit-half|10mbit-full|100mbit-full>
```

```
state <dhcp|bootp|static|disable>
```

```
[ipaddr <IP Address> mask <Mask>]
```

```
[ipv6addr <IP v6 Address/Prefix>]
```

Description

Configures Ethernet port 1 or 2.

The following list includes options which accept the CLEAR command:

Note: CLEAR *must be in all caps*.

```
set network          domain
```

```
show network dns
```

Syntax

```
ujqy"pgvyqtm" fpu
```

Description

Displays DNS settings.

```
show network gateway
```

Syntax

```
show network gateway
```

Description

Displays gateway settings.

```
show network host
```

Syntax

```
show network host
```

Description

Displays the network host name of the SLB.

```
show network port
```

Syntax

```
ujqy"pgvyqtm"rqtv">3~4@
```

Description

Displays Ethernet port settings and counters.

```
show network all
```

Syntax

```
show network all
```

Description

Displays all network settings.

NFS and SMB/CIFS Commands

```
set nfs mount
```

Syntax

```
set nfs mount <one or more parameters>
```

Parameters

```
locdir <Directory>
oqwpv">gpcdng~fkucdng@
tgofkt">Tgoqvg"PHU"Fktgevqt{@
ty">gpcdng~fkucdng@"
Gpcdngu"qt"fkucdngu"read/write access to remote directory.
```

Description

Mounts a remote NFS share.

The `remdir` and `locdir` parameters are required, but if they have been specified previously, you do not need to provide them again.

```
set nfs unmount
```

Syntax

```
set nfs unmount <1|2|3>
```

Description

Unmounts a remote NFS share.

The following list includes options which accept the CLEAR command:

Note: CLEAR *must be in all caps*.

```
set localusers      custommenu, escapeseq, breakseq, dialbacknumber,
                    accessoutlets, listenports, dataports, clearports
```

```
set cifs
```

Syntax

```
set cifs <one or more parameters>
```

Parameters

```
eth1 <enable|disable>
eth2 <enable|disable>
state <enable|disable>
workgroup <Windows workgroup>
```

Description

Configures the SMB/CIFS share, which contains the system and device port logs.

The `admin config` command saves SLB configurations on the SMB/CIFS share.

```
set cifs password
```

Syntax

```
set cifs password
```

Description

Changes the password for the SMB/CIFS share login (default is **cifsuser**).

Enables or disables authentication of local users.

The following list includes options which accept the CLEAR command:

Note: CLEAR *must be in all caps*.

```
set cifs                workgroup
```

show cifs

Syntax

```
show cifs
```

Description

Displays SMB/CIFS settings.

show nfs

Syntax

```
ujqy"phu
```

Description

Displays NFS share settings.

Performance Monitoring Commands

show perfmon

Syntax

```
show perfmon
```

Parameters

```
show perfmon [probe <all|Probe Id or Name>]
```

Description

Display global settings and all probes, or a selected probe.

show perfmon status**Syntax**

```
show perfmon status
```

Parameters

```
show perfmon status [probe <Probe Id or Name>]
```

Description

Display the running status of all probes or a selected probe.

show perfmon operations**Syntax**

```
show perfmon operations
```

Parameters

```
show perfmon operations <Probe Id or Name>
```

Description

Display list of completed operation sets for a probe.

set perfmon results**Syntax**

```
set perfmon results
```

Parameters

```
show perfmon results <Probe Id or Name> [set <Operation Set Number>]  
[display <head|tail>] [numlines <Number of Lines>]  
[email <Email Address>]
```

Description

Display round trip times (RTT) for last completed operation set or selected set, and optionally email the complete results.

show perfmon accumulated**Syntax**

```
show perfmon accumulated
```

Parameters

```
show perfmon accumulated <Probe Id or Name> [set <Operation Set Number>]
[email <Email Address>]
```

Description

Display accumulated statistics for last completed operation set or selected set, and optionally email the statistics.

```
set perfmon repo
```

Syntax

```
set perfmon repo <local|usb> [usbport U1]
```

Description

Set repository where probe operations are stored.

```
set perfmon keep
```

Syntax

```
set perfmon keep <Number of Operations to Keep>
```

Description

Set number of operations stored for each probe.

```
set perfmon udpjitterresp
```

Syntax

```
set perfmon udpjitterresp <enable|disable>
```

Description

Enable responders for UDP jitter.

```
set perfmon udpechoresp
```

Syntax

```
set perfmon udpechoresp <UDP Port Number|disable>
```

Description

Enable responders for UDP echo.

set perfmon tcpconnectresp**Syntax**

```
set perfmon tcpconnectresp <TCP Port Number|disable>
```

Description

Enable responders for TCP connect.

set perfmon add**Syntax**

```
set perfmon add <Probe Name>
type <dns|http|icmp|tcpconnect|udpecho|udpjitter|udpjittervoip>
```

Parameters

```
name <Probe Name>
starttime <now|HH:MM[:SS] [MMDD] |afterHH:MM:SS>
operations <Number of Operations to Perform>
frequency <Seconds between Operations>
packets <Number of Packets to Send>
interval <Milliseconds between Packets>
timeout <Milliseconds to Wait for Response>
host <Destination IP Address or Name>
port <Destination Port>
precision <milli|micro>
datasize <Payload Data Size in Bytes>
verifydata <enable|disable>
codec <g729a|g711alaw|g711mulaw>
tos <none|Type of Service>
interface <none|eth1|eth2>
nameserver <IPv4 Address>
```

Description

Add a new probe.

set perfmon edit**Syntax**

```
set perfmon edit <Probe Id or Name> [<parameters>]
```

Parameters

```
name <Probe Name>
starttime <now|HH:MM[:SS] [MMDD] |afterHH:MM:SS>
operations <Number of Operations to Perform>
frequency <Seconds between Operations>
```

```

packets <Number of Packets to Send>
interval <Milliseconds between Packets>
timeout <Milliseconds to Wait for Response>
host <Destination IP Address or Name>
port <Destination Port>
precision <milli|micro>
datasize <Payload Data Size in Bytes>
verifydata <enable|disable>
codec <g729a|g711alaw|g711mulaw>
tos <none|Type of Service>
interface <none|eth1|eth2>
nameserver <IPv4 Address>

```

Description

Edit an existing probe.

```
set perfmon delete
```

Syntax

```
set perfmon delete <Probe Id or Name> [data <all|# of Sets to Keep>]
```

Description

Delete a probe, or delete all operation data for a probe, or delete all but the most recent operation sets for a probe.

```
set perfmon state
```

Syntax

```
set perfmon state <all|Probe Id or Name> action <restart>
```

Description

Set the running state of all probes or a single a probe.

Power Commands

```
set power alarmthreshold
```

Syntax

```
set power alarmthreshold <disable|Tenths of Amps>
```

Description

Number of amps (measured in tenths of an amp) above which the SLB branch office manager sends a trap. The maximum is 180.

Note: *If the alarm goes off, a warning message displays on the CLI.*

```
set power outlet
```

Syntax

```
set power outlet <Outlet # or List or Name> <one or more parameters>
```

Parameters

```
name <Outlet Name>
description <Outlet Description>
state <on|off>
wakeup <on|off|laststate>
reboot
```

Description

Configures and controls power outlets.

Example

```
set power outlet 1-2,4 state on
```

```
set power switchingdelay
```

Syntax

```
set power switchingdelay <Delay in msec>
```

Description

Sets the delay after switching on an outlet before switching on the next.

```
show power
```

Syntax

```
show power <Outlet # or Name>
```

Description

Displays power settings for all outlets or for a single outlet.

Note: *the screen displays **PND** when the outlet is powering up and is waiting for the delay period to expire. It displays **RBT** when an outlet has been told to reboot and is*

waiting for the reboot interval to expire (default is 20 seconds.) The switching delay and the reboot interval are completely independent of each other.

Routing Commands

set routing

Syntax

```
set routing [parameters]
```

Parameters

```
rip <enable|disable>
route <1-64> ipaddr <IP Address> mask <Netmask> gateway <IP Address>
static <enable|disable>
version <1|2|both>
```

Description

Configures static or dynamic routing.

To delete a static route, set the IP address, mask, and gateway parameters to **0.0.0.0**.

show routing

Syntax

```
show routing [resolveip <enable|disable>] [email <Email Address>]
```

Description

Sets the routing table to display IP addresses (disable) or the corresponding host names (enable). You can optionally email the displayed information.

Script Commands

set script import

Syntax

```
set script import <interface|batch|custom> via <ftp|scp|coppypaste>
[file <Script File>] [name <Script Name>] [host <IP Address
or Name>]
[login <User Login>] [path <Path to Script File>]
[filetype <expect|tcl|python>]
```

Note: Interface scripts will be given default/do user rights; Batch and Custom scripts will be given admin/ad user rights. The name of the script will be the same as the file name (if it is a valid script name), otherwise a script name must be specified for import.

Description

Import a script.

set script update

Syntax

```
set script update <interface|batch|custom> name <Script Name>
                [group <default|power|admin>] [permissions <Permission List>]
```

Note: See 'help user permissions' for information on groups and user rights.

Description

Update a script.

set script rename

Syntax

```
set script rename <interface|batch|custom> name <Script Name>
                newname <New Script Name>
```

Description

Rename a script.

set script delete

Syntax

```
set script delete <interface|batch|custom> name <Script Name>
```

Description

Delete a script.

set script runcli

Syntax

```
set script runcli <Script Name> [parameters <Command Line Parameters>]
                [debug <enable|disable>]
```

Description

Run a CLI batch or custom script one time (script output will be displayed in the current terminal; custom script output will be saved in the repository).

connect script**Syntax**

```
connect script <Script Name> deviceport <Device Port # or Name>
      [parameters <Command Line Parameters>] debug
      <enable|disable>]
```

Description

Connect an interface or custom script to a Device Port and run it one time (script output will be displayed in the current terminal; custom script output will be saved in the repository).

set script schedule**Syntax**

```
set script schedule <Script Name> [device <cli|Device Port # or Name>]
      [state <enable|disable|delete>] [parameters
      <Cmd Line Parameters>]
      [starttime <now|HH:MM [MMDD] |afterHH:MM>]
      [frequency <Hours/Days between each operation>]
      [stoptime <forever|HH:MM [MMDD] |afterHH:MM>]
```

Description

Schedule a custom script to be run at a certain time, either once or recurring; frequency is specified as hours (4H for 4 hours) or days (2D for 2 days).

show script**Syntax**

```
show script [type <interface|batch|custom> [name <Script Name>]]
```

Description

Display list of scripts, or view the details and contents of a script.

show script status**Syntax**

```
show script status [script <Script Name>]
```

Description

Display the running status of all custom scripts or a single custom script.

show script operations**Syntax**

```
show script operations <Script Name>
```

Description

Display list of completed results for a custom script.

show script results**Syntax**

```
show script results <Script Name> [set <all|Operation Set Number>]
    [display <head|tail>] [numlines <Number of Lines>]
    [email <Email Address>]
```

Description

Display the results for the last completed custom script operation or a selected operation, and optionally email the results.

Services Commands

set services**Syntax**

```
ugv"ugtxkegu">qpg"qt"oqtg"ugtxkegu"rctcogvgtu@
```

Parameters

```
alarmdelay <1-6000 Seconds>
auditlog <enable|disable>
auditsize <1-500 in Kbytes>
authlog <off|error|warning|info|debug>
clicommands <enable|disable>
contact <Admin contact info>
devlog <off|error|warning|info|debug>
diaglog <off|error|warning|info|debug>
dsakeys <enable|disable>
escapeseqtelnet <1-10 Chars>
genlog <off|error|warning|info|debug>
includesyslog <enable|disable>
location <Physical Location>
netlog <off|error|warning|info|debug>
nms1 <IP Address or Name>
nms2 <IP Address or Name>
```

```

outgoingtelnet <enable|disable>
phonehome <enable|disable>
phoneip <IP Address>
portssh <TCP Port>
rocommunity <Read-Only Community>
rwcommunity <Read-Write Community>

```

Sets a password for an SNMP manager to access the read-only data the SLB SNMP agent provides and to modify data where permitted.

```

servlog <off|error|warning|info|debug>
smtpserver <IP Address or Hostname>
snmp <enable|disable>
ssh <enable|disable>
sha2 <enable|disable>
syslogserver1 <IP Address or Name>
syslogserver2 <IP Address or Name>
telnet <enable|disable>
termbufsize <Number of Lines>
timeoutssh <disable or 1-30>
timeouttelnet <disable or 1-30>
traps <enable|disable>
trapcommunity <Trap Community>
v1 <enable|disable>
v1ssh <enable|disable>
v2c <enable|disable>
v3auth <md5|sha>
v3encrypt <des|aes>
v3user <V3 RW User>
v3user <V3 RO User>
v3rwuser <V3 RW User>
v3security <noauth|auth|authencrypt>
webssh <enable|disable>
webtelnet <enable|disable>

```

Set SNMP v3 read-only password/passphrase or read-write password/passphrase:

```
set services v3password|v3phrase|v3rwpassword|v3rwphrase
```

Defines the set of SNMP traps that are sent by the SLB:

```
set services trapenable
```

Description

Configure system and audit logging, SSH and Telnet access to the CLI, the SNMP agent, and the email (SMTP) server.

The following list includes options which accept the CLEAR command:

Note: CLEAR *must be in all caps*.

```
set services          location, contact, v3phrase, v3rwphrase,
                    phonenumber
```

show services**Syntax**

```
show services
```

Description

Displays current services.

show services trapenable**Syntax**

```
show services trap enable
```

Description

Defines the set of SNMP traps that are sent by the SLB.

Site Commands

set site**Syntax**

Create or edit a site:

```
set site add|edit <Site Name> [<parameters>]
      Description
```

Configure a set of site-oriented modem parameters that can be activated by various modem-related events (authentication, outbound network traffic for DOD connections, etc.). The site parameters will override any parameters configured for the modem. To use sites with a modem, enable 'usesites'. Sites can be used with the following modem states: dialin, dialback, cbcpserver, dialondemand, dialin+ondemand, and dialback+ondemand.

Parameters

```
allowdialback <enable|disable>
auth <pap|chap>
cbcpnocallback <enable|disable>
deviceport <Device Port # or Name or none>
dialbackdelay <Dial-back Delay>
dialbacknumber <Phone Number>
dialbackretries <1-10>
dialoutlogin <User Login>
dialoutnumber <Phone Number>
localipaddr <negotiate|IP Address>
loginhost <User Login/CHAP Host>
```

```

modemtimeout <disable|1-9999 secs>
name <Site Name> (edit only)
nat <enable|disable>
remoteipaddr <negotiate|IP Address>
restartdelay <PPP Restart Delay>
routegateway <Gateway>
routeipaddr <IP Address>
routemask <Mask>
timeoutlogins <disable|1-30 minutes>
usbport <U1>

```

Set the site password and CHAP secret (any extra parameters will be ignored):

```

set site dialoutpassword <Site Name>
set site chapsecret <Site Name>

```

Deletes a site:

```

set site delete <Site Name>

show site <all|names|Site Name>

```

Secure Lantronix Network Commands

set slcnetwork

Syntax

```
set slcnetwork <one or more parameters>
```

Parameters

```

add <IP Address>
delete <IP Address>
search <localsubnet|ipaddrlist|both>

```

Description

Detects and displays all SLB branch office manager or user-defined IP addresses on the local network.

show slcnetwork

Syntax

```
show slcnetwork [ipaddrlist <all|Address Mask>]
```

Description

Detects and displays all SLBs on the local network.

Without the `ipaddrlist` parameter, the command searches the SLB network. With the `ipaddrlist` parameter, the command displays a sorted list of all IP addresses or displays the IP addresses that match the mask (for example, 172.19.255.255 would display all IP addresses that start with 172.19).

SSH Key Commands

```
set sshkey all export
```

Syntax

```
set sshkey allexport <ftp|scp|coppypaste> [pubfile <Public Key File>] [host <IP Address or Name>] [login <User Login>] [path <Path to Copy Keys>]
```

Description

Exports the public keys all of the previously created SSH keys.

```
set sshkey delete
```

Syntax

```
set sshkey delete <one or more parameters>
```

Parameters

```
keyhost <SSH Key Host>
keyname <SSH Key Name>
keyuser <SSH Key User>
```

Description

Deletes an ssh key.

Specify the `keyuser` and `keyhost` to delete an imported key; specify the `keyuser` and `keyname` to delete exported key.

```
set sshkey export
```

Syntax

```
set sshkey export <ftp|scp|coppypaste> <one or more parameters>
```

Parameters

```
[format <openssh|secsh>]
[host <IP Address or Name>]
[login <User Login>]
```

```
[path <Path to Copy Key>]
bits <512|1024|2048>
keyname <SSH Key Name>
keyuser <SSH Key User>
type <rsa|dsa>
```

Description

Exports an sshkey.

```
set sshkey import
set sshkey import <ftp|scp|coppaste> <one or more parameters>
```

Parameters

```
[keyhost <SSH Key IP Address or Name>]
[keyuser <SSH Key User>]
[path <Path to Public Key File>]
file <Public Key File>
host <IP Address or Name>
login <User Login>
```

Description

Imports an SSH key.

```
set sshkey server import
```

Syntax

```
set sshkey server import type <rsa1|rsa|dsa> via <sftp|scp>
    pubfile <Public Key File> privfile <Private Key File>
    host <IP Address or Name> login <User Login> [path <Path to Key File>]
```

Description

Imports an SLB host key.

```
set sshkey server reset
```

Syntax

```
set sshkey server reset [type <all|rsa1|rsa|dsa>]
```

Description

Resets defaults for all or selected host keys.

show sshkey export**Syntax**

```
show sshkey export <one or more parameters>
```

Parameters

```
[keyhost <SSH Key IP Address or Name>]  
[keyuser <SSH Key User>]  
[viewkey <enable|disable>]
```

Description

Displays all exported keys or keys for a specific user, IP address, or name.

show sshkey import**Syntax**

```
show sshkey import <one or more parameters>]
```

Parameters

```
[keyhost <SSH Key IP Address or Name>]  
[keyuser <SSH Key User>]  
[viewkey <enable|disable>]
```

Description

Displays all keys that have been imported or keys for a specific user, IP address, or name.

show sshkey server**Syntax**

```
show sshkey server [type <all|rsa1|rsa|dsa>]
```

Description

Displays host keys (public key only).

Status Commands

show connections

Syntax

```
show connections [email <Email Address>]
```

Description

Displays a list of current connections. Optionally emails the displayed information. The connection IDs are in the left column of the resulting table. The connection ID associated with a particular connection may change if the connection times out and is restarted.

show connections connid

Syntax

```
ujqy"eqppgevkqpu"eqppkf">Eqppgevkqp"KF@" ] gockn">Gockn"Cfftguu@_0
```

Description

Provides details, for example, endpoint parameters and trigger, for a specific connection. Optionally emails the displayed information.

Note: Use the basic `show connections` command to obtain the Connection ID.

show portcounters

Syntax

```
show portcounters [deviceport <Device Port List or Name>] [email <Email Address>]
```

Description

Generates a report for one or more ports. Optionally emails the displayed information.

show portstatus

Syntax

```
show portstatus [deviceport <Device Port List or Name>] [email <Email Address>]
```

Description

Displays device port modes and states for one or more ports. Optionally emails the displayed information.

show sysconfig

Syntax

```
show sysconfig [display <basic|auth|devices>] [email <Email Address>]
```

Description

Displays a snapshot of all configurable parameters. Optionally emails the displayed information.

show sysstatus

Syntax

```
show sysstatus [email <Email Address>]
```

Description

To display the overall status of all SLB devices. Optionally emails the displayed information.

System Log Commands

show syslog

Syntax

```
ujqy"u{unqi"}>rctcogvgtu@_
```

Parameters

```
[email <Email Address>]
level <error|warning|info|debug>
log <all|netlog|servlog|authlog|devlog|diaglog|genlog>
display <head|tail> [numlines <Number of Lines>]
starttime <MMDDYYhhmm[ss]>
endtime <MMDDYYhhmm[ss]>
```

Description

Displays the system logs containing information and error messages.

Note: *The level, display, and time parameters cannot be used simultaneously.*

show syslog clear

Syntax

```
show syslog clear <all|netlog|servlog|authlog|devlog|diaglog|genlog>
```

Description

Clears one or all of the system logs.

USB Storage Commands

```
set usb storage dir
```

Syntax

```
set usb storage dir <u1>
```

Description

Views a directory listing of a Compact Flash card.

```
set usb storage format
```

Syntax

```
set usb storage fsck
```

Description

Views a directory listing of a file system check.

```
set usb storage fsck <u1>
```

Syntax

```
set usb storage format <u1> [filesystem <ext2|fat>]
```

Description

Formats a Compact Flash card.

```
set usb storage mount
```

Syntax

```
set usb storage mount <u1>
```

Description

Mounts a Compact Flash card in the SLB branch office manager for use as a storage device. The Compact Flash card must be formatted with an ext2 or FAT file system before you mount it.

```
set usb storage unmount
```

Syntax

```
set usb storage unmount <u1>
```

Description

Wpqowpvu" c"WUD"hncuj"ectf0" Enter this command before ejecting the card.

USB Modem Commands

```
set usb modem
```

Syntax

```
set usb modem <u1|u2> <parameters>
```

Parameters

```
auth <pap|chap>
baud <300-115200>
calleridcmd <Modem Command String>
calleridlogging <enable|disable>
cbcpnocallback <enable|disable>
cbcptype <admin|user>
chapauth <chaphost|localusers>
chaphost <CHAP Host or User Name>
checkdialtone <disable|5-600 mins>
databits <7|8>
dialbackdelay <PPP Dialback Delay>
dialbacknumber <username|Phone Number>
dialbackretries <1-10>
dialinlist <Host List for Dial-in>
dialoutlogin <Remote User Login>
dialoutnumber <Phone Number>
dodauth <pap|chap>
dodchaphost <CHAP Host or User Name>
flowcontrol <none|xon/xoff|rts/cts>
group <Local or Remote Group Name>
initscript <Modem Init Script>
localipaddr <negotiate|IP Address>
modemmode <text|ppp>
modemtimeout <disable|1-9999 sec>
nat <enable|disable>
parity <none|odd|even>
remoteipaddr <negotiate|IP Address>
restartdelay <PPP Restart Delay>
service <none|telnet|ssh|tcp>
sshauth <enable|disable>
```

```

sshport <TCP Port>
stopbits <1|2>
tcpauth <enable|disable>
tcpport <TCP Port>
telnetauth <enable|disable>
telnetport <TCP Port>
timeoutlogins <disable|1-30 minutes>
usesites <enable|disable>

```

Set the modem password and CHAP secrets (any extra parameters will be ignored):

```

set usb modem <U1|U2> dialoutpassword
set usb modem <U1|U2> chapsecret
set usb modem <U1|U2> dodchapsecret

```

Note: *It is recommended that the initscript be prepended with 'AT' and include E1 V1 x4 Q0 so that the SLB may properly control the modem.*

Mounts a thumb drive for use as a storage device. The thumb drive can be used for saving configurations and device logging.

```
set usb storage mount <U1>
```

Unmounts a thumb drive:

```
set usb storage unmount <U1>
```

Runs a filesystem check on a thumb drive (recommended if it does not mount):

```
set usb storage fsck <U1>
```

Displays a directory listing of a thumb drive:

```
set usb storage dir <U1>
```

Renames a file on a thumb drive:

```
set usb storage rename <U1> file <Filename> newfile <New Filename>
```

Copies a file on a thumb drive:

```
set usb storage copy <U1> file <Filename> newfile <New Filename>
```

Removes a file on a thumb drive:

```
set usb storage delete <U1> file <Current Filename>
```

Formats a thumb drive:

```
set usb storage format <U1> [filesystem <ext2|fat16|fat32>]
```

Defaults: filesystem=ext2

Display currently attached USB devices with product information and settings:

```
show usb
```

Display product information and settings for any USB thumb drive:

```
show usb storage
```

Display product information and settings for any USB modem:

```
show usb modem
```

Description

Configures a currently loaded USB Modem.

The following list includes options which accept the CLEAR command:

Note: CLEAR *must be in all caps*.

```
set usb modem      dialinlist, chapost, chapsecret, dodchapost,  
                  dodchapsecret, initscript, dialoutlogin,  
                  dialoutpassword, dialbacknumber, group
```

```
set vpn
```

Syntax

```
set vpn
```

Description

Sets the vpn.

The following list includes options which accept the CLEAR command:

Note: CLEAR *must be in all caps*.

```
set vpn            name, remoteid, localid, remotesubnet, localsubnet,  
                  xauthlogin
```

```
show vpn
```

Syntax

```
show vpn
```

Description

Shows the vpn.

```
set temperature
```

Syntax

```
set temperature
```

Description

Sets the temperature.

show temperature

Syntax

show temperature

Description

Shows the temperature.

Appendix A: Bootloader

The vSLM management appliance provides a bootload command interface. This interface is only accessible through the SLB unit's console port.

Accessing the Bootloader

To access the bootloader command line interface (CLI):

1. Power on the SLB.
2. Type x15 within 10 seconds of power up.

The bootloader halts the boot procedure and displays a **Lantronix** command prompt.

Bootload Commands

Table A-1 User Commands

Command	Description
Help	Lists and prints the command list and online help.
?	An alias for help.
Boot	Boot default (runs bootcmd).
Bootcheck	Checks boot bank information.
Bootinfo	Displays boot bank information.
bootSEL 1 2	Selects boot bank 1 or boot bank 2.
IDE	Accesses the IDE sub-system.
Mtest	Performs a simple test of the RAM.
Ping	Sends a query to determine whether a connectino exists.
Printenv	Displays the values of environment variables.
setenv	Assigns values to environment variables
su cust admin	Switches to another user: from cust (customer) to adm (administrator) and vice versa.
Version	Prints the bootloader version.
whoami	Displays information about the current user.

Table A-2 Administrator Commands

In addition to the commands that the user can issue, the administrator can issue the following:

Command	Description
Imagecopy	Copies an image of the drive from the lower PCMCIA device to the internal CF card.
Passwd	Provides a new password for user admin. The default password for user admin is admin. User cust does not have a password.
Ping	Sends a ping request to the network host.
Printenv	Prints bootloader variables.
Setenv	Sets environment variables.

Appendix B: Security Considerations

The SLB branch office manager provides data path security by means of SSH or Web/SSL. Even with the use of SSH/SSL, however, do not assume you have complete security. Securing the data path is only one measure needed to ensure security. This appendix briefly discusses some important security considerations.

Security Practice

Develop and document a Security Practice. The Security Practice should state:

- ◆ The dos and don'ts of maintaining security. For example, the power of SSH and SSL is compromised if users leave sessions open or advertise their password.
- ◆ The assumptions that users can make about the facility and network infrastructure, for example, how vulnerable the CAT 5 wiring is to tapping.

Factors Affecting Security

External factors affect the security provided by the SLB unit, for example:

- ◆ Telnet sends the login exchange as clear text across Ethernet. A person snooping on a subnet may read your password.
- ◆ A terminal to the SLB device may be secure, but the path from the SLB branch office manager to the end device may not be secure.
- ◆ With the right tools, a person having physical access to open the SLB unit may be able to read the encryption keys.
- ◆ There is no true test for a denial-of-service attack-there is always a legitimate scenario for a request storm. A denial-of-service filter locks out some high-performance automated/scripted requests. The SLB branch office manager will attempt to service all requests and will not filter out potential denial-of-service attacks.

Appendix C: Adapters and Pinouts

The serial device ports of the SLB products match the RJ45 pinouts of the console ports of many popular devices found in a network environment. The SLB branch office manager uses conventional straight-through Category 5 fully pinned network cables for all connections when used with Lantronix adapters. The cables are available in various lengths.

In most cases, you will need an adapter for your serial devices. Lantronix offers a variety of RJ45-to-serial connector adapters for many devices. These adapters convert the RJ45 connection on the SLB unit to a 9-pin or 25-pin serial connector found on other manufacturers' serial devices or re-route the serial signals for connections to other devices that use RJ45 serial connectors.

Please check the cabling database on the Lantronix Web site at www.lantronix.com for suggested cables and adapters for commonly used serial devices.

The console port is wired the same way as the device ports and has the same signal options.

Note: You can view or change the console port settings using the LCDs and keypads on the front panel, the [Devices > Console Port](#) page, or the command line interface `show console port` and `set consoleport` commands.

The adapters illustrated below are compatible with the Lantronix SLB models.

Figure C-1 RJ45 Receptacle to DB25M DCE Adapter for the SLB (PN 200.2066A)

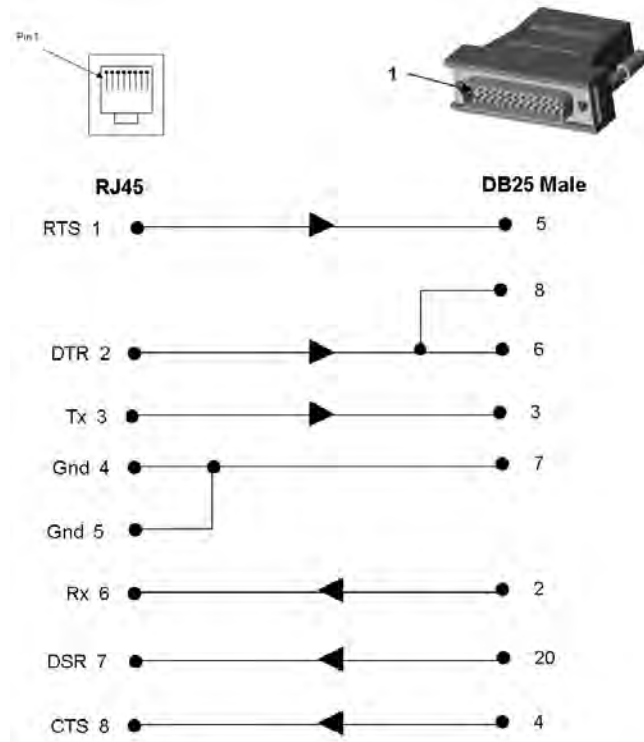

Use PN 200.2066A adapter with a dumb terminal or with many SUN applications.

Figure C-2 RJ45 Receptacle to DB25F DCE Adapter for the SLB (PN 200.2067A)

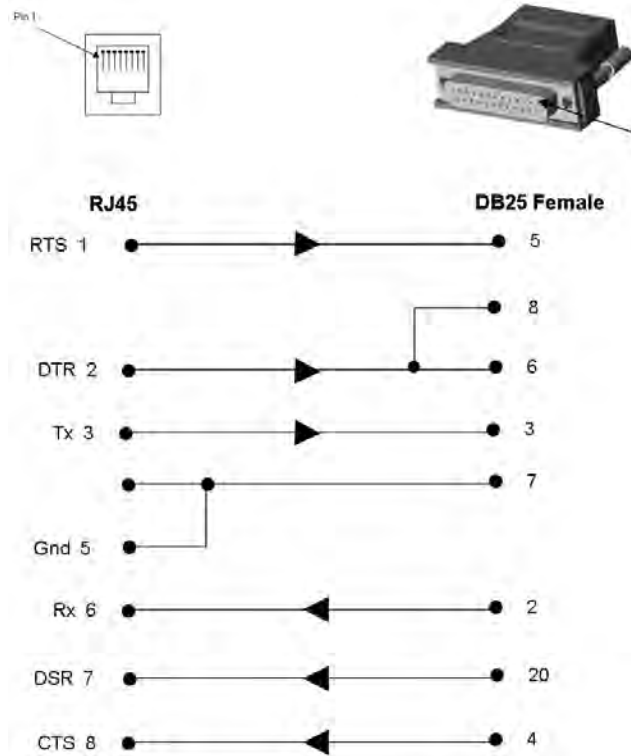

Figure C-3 RJ45 Receptacle to DB9M DCE Adapter for the SLB (PN 200.2069A)

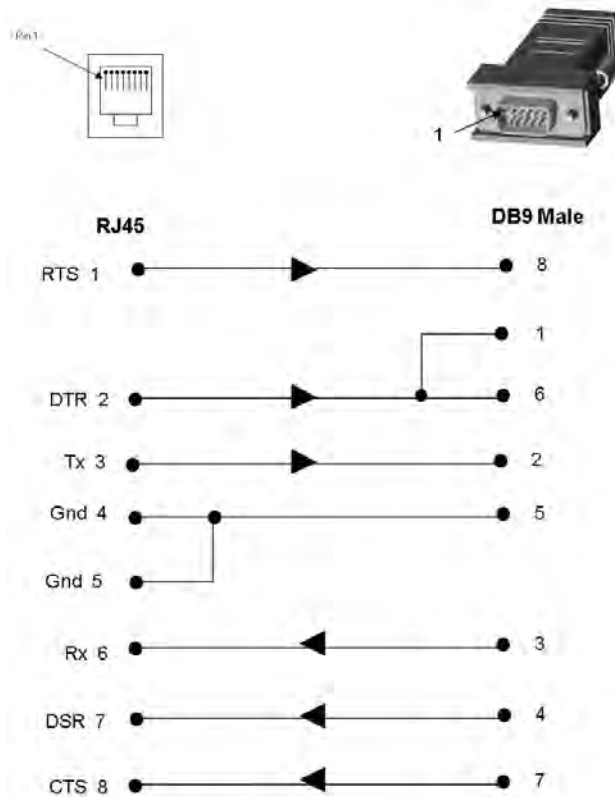
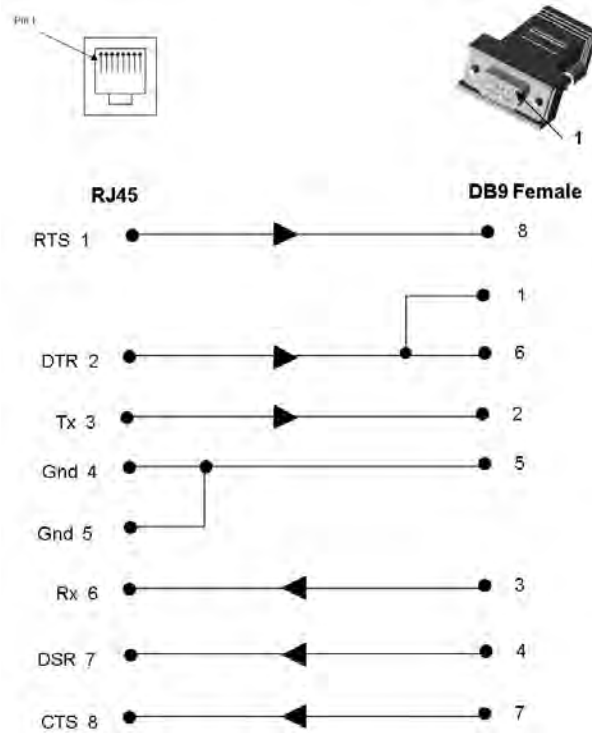
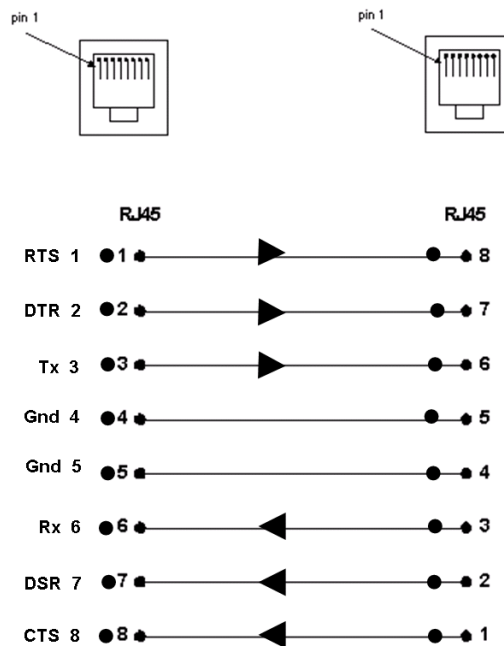

Figure C-4 RJ45 Receptacle to DB9F DCE Adapter for the SLB (PN 200.2070A)



Use PN 200.2070A adapter with a PC's serial port.

Figure C-5 RJ45 to RJ45 Adapter for Netra/Sun/Cisco and SLP (PNs 200.2225 and ADP010104-01)



Note: The cable ends of the ADP010104-01 are an RJ45 socket on one end and a RJ45 plug on the other instead of RJ45 sockets on both ends.

Use this adapter for SLP Remote Power Manager, Netra/SUN/CISCO, and others.

Appendix D: Protocol Glossary

BOOTP (Bootstrap Protocol)

Similar to DHCP, but for smaller networks. Automatically assigns the IP address for a specific duration of time.

CHAP (Challenge Handshake Authentication Protocol)

A secure protocol for connecting to a system; it is more secure than the PAP.

DHCP (Dynamic Host Configuration Protocol)

Internet protocol for automating the configuration of computers that use TCP/IP.

DNS (Domain Name Servers)

A system that allows a network nameserver to translate text host names into numeric IP addresses.

IPsec

A protocol suite for securing Internet Protocol (IP) communications by authenticating and encrypting each IP packet of a communication session.

Kerberos

A network authentication protocol that provides strong authentication for client/server applications by using secret-key cryptography.

LDAP (Lightweight Directory Access Protocol)

A protocol for accessing directory information.

NAT (Network Address Translation)

An Internet standard that enables a LAN to use one set of IP addresses for internal traffic and a second set of addresses for external traffic. This enables a company to shield internal addresses from the public Internet.

NFS (Network File System)

A protocol that allows file sharing across a network. Users can view, store, and update files on a remote computer. You can use NFS to mount all or a portion of a file system. Users can access the portion mounted with the same privileges as the user's access to each file.

NIS (Network Information System)

System developed by Sun Microsystems for distributing system data such as user and host names among computers on a network.

NMS (Network Management System)

NMS acts as a central server, requesting and receiving SNMP-type information from any computer using SNMP.

NTP (Network Time Protocol)

A protocol used to synchronize time on networked computers and equipment.

PAP (Password Authentication Protocol)

A method of user authentication in which the username and password are transmitted over a network and compared to a table of name-password pairs.

PPP (Point-to-Point Protocol)

A protocol for creating and running IP and other network protocols over a serial link.

RADIUS (Remote Authentication Dial-In User Service)

An authentication and accounting protocol. Enables remote access servers to communicate with a central server to authenticate dial-in users and their access permissions. A company stores user profiles in a central database that all remote servers can share.

SMB/CIFS

(Server Message Block/Common Internet File System): Microsoft's protocol for allowing all applications as well as Web browsers to share files across the Internet. CIFS runs on TCP/IP and uses the SMB protocol in Microsoft Windows for accessing files. With CIFS, users with different platforms and computers can share files without having to install new software.

SNMP (Simple Network Management Protocol)

A protocol that system administrators use to monitor networks and connected devices and to respond to queries from other network hosts.

SMTP (Simple Mail Transfer Protocol)

TCP/IP protocol for sending email between servers.

SSL (Secure Sockets Layer)

A protocol that provides authentication and encryption services between a web server and a web browser.

SSH (Secure Shell)

A secure transport protocol based on public-key cryptography.

TACACS+ (Terminal Access Controller Access Control System)

A method of authentication used in UNIX networks. It allows a remote access server to communicate with an authentication server to determine whether the user has access to the network.

Telnet

A terminal protocol that provides an easy-to-use method of creating terminal connections to a network host.

Appendix E: Compliance Information

Manufacturer's Name & Address

Lantronix, Inc. 7535 Irvine Center Drive Suite 100 Irvine, CA 92618, USA

Declares that the following product:

Product Name(s): Lantronix® SLB™ Branch Office Manager

Conforms to the following standards or other normative documents:

Regulatory Compliance

Safety: Low Voltage Directive (2014/35/EC) and (2014/35/EU)

- ◆ EN 60950-1:2006 + A11:2009 +A1:2010 + A12:2011 + A2:2013
- ◆ UL 60950-1, 2nd Edition, 2011-12-19 (Information Technology Equipment - Safety - Part 1: General Requirements)
- ◆ CSA C22.2 No. 60950-1-07, 2nd Edition, 2011-12 (Information Technology Equipment - Safety - Part 1: General Requirements)

EMC: EMC Directive (2014/30/EU)

Emissions

- ◆ FCC Part 15 Subpart B
- ◆ Industry Canada ICES-003 Issue 5
- ◆ VCCI V-3/2013.04
- ◆ AS/NZS CISPR 22: 2009
- ◆ EN 55022: 2011

Immunity

- ◆ EN 55024: 2010
- ◆ EN 61000-4-2: 2009
- ◆ EN 61000-4-3: 2006 + A1: 2010
- ◆ EN 61000-4-4: 2012
- ◆ EN 61000-4-5: 2006
- ◆ EN 61000-4-6: 2009
- ◆ EN 61000-3-2: 2006/A2: 2009
- ◆ EN 61000-4-8: 2010
- ◆ EN 61000-3-3: 2008
- ◆ EN 61000-4-11: 2004

CCC: GB4943.1-2011, GB 9254-2008, GB 17625.1-2012

FCC NOTICE (U.S. Only)

This equipment has been tested and found to comply with the limits for a Class A digital device pursuant to Part 15 of the FCC Rules. These limits are designed to provide reasonable protection against harmful interference when the equipment is operated in a commercial environment. This equipment generates, uses, and can radiate radio frequency energy and, if not installed and used in accordance with the manufacturer's instruction manual, may cause harmful interference with radio communications. Operation of this equipment in a residential area is likely to cause harmful interference, in which case you will be required to correct the interference at your own expense.

INDUSTRY CANADA NOTICE (Canada Only)

This Class A digital apparatus complies with Canadian ICES-003.

Cet appareil numérique de la classe A est conforme à la norme NMB-003 du Canada.

RoHS Compliance

This product meets the requirements of 2002/95/EC European RoHS and also complies with the SJ/T 11363-2006 Peoples Republic of China, Requirements for Concentration Limits on Certain Hazardous Substances in Information Technology Products.

Additional Agency Approvals and Certifications

- ◆ VCCI
- ◆ UL/CUL
- ◆ C-Tick
- ◆ PSE
- ◆ CCC*

Note: *Only applies to 200-240 VAC SLB (specifically P/Ns SLB8824KIT-AP and SLB8824KIT-WW).

RoHS, REACH and WEEE Compliance Statement

Please visit <http://www.lantronix.com/legal/rohs/> for Lantronix's statement about RoHS, REACH and WEEE compliance.