

## SiC SBD P3D06040K3 650V SiC Schottky Diode



### Features

- Qualified to AEC-Q101
- Ultra-Fast Switching
- Zero Reverse Recovery Current
- High-Frequency Operation
- Positive Temperature Coefficient on  $V_F$
- High Surge Current
- 100% UIS tested

TO-247-3

Anode	1
Cathode	2
Anode	3

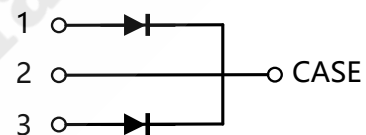

### Benefits

- Improve System Efficiency
- Reduction of Heat Sink Requirement
- Essentially No Switching Losses
- Parallel Devices Without Thermal Runaway



### Applications

- Consumer SMPS
- Boost Diodes in PFC or DC/DC Stages
- AC/DC Converters



### Order Information

Part Number	Package	Marking
P3D06040K3	TO-247-3	P3D06040K3



## Contents

Features.....	1
Benefits.....	1
Applications.....	1
Order Information .....	1
<b>Contents.....</b>	<b>2</b>
1. Maximum Ratings.....	3
2. Thermal Characteristics.....	3
3. Electrical Characteristics .....	4
4. Typical Performance .....	5
5. Package Outlines.....	6

PNJ Preliminary

## 1. Maximum Ratings

At  $T_J = 25^\circ\text{C}$ , unless specified otherwise

Parameter	Symbol	Value	Unit	Test condition
Repetitive Peak Reverse Voltage	$V_{RRM}$	650	V	$T_C = 25^\circ\text{C}$
Surge Peak Reverse Voltage	$V_{RSM}$	650	V	$T_C = 25^\circ\text{C}$
DC Blocking Voltage	$V_R$	650	V	$T_C = 25^\circ\text{C}$
Forward Current (Per Leg/Device)	$I_F$	53/106 29/58 20/40	A	$T_C = 25^\circ\text{C}$ $T_C = 125^\circ\text{C}$ $T_C = 150^\circ\text{C}$
Repetitive Peak Forward Surge Current (Per Leg)	$I_{FRM}$	100 52	A	$T_C = 25^\circ\text{C}, t_p = 10\text{ms}$ $T_C = 125^\circ\text{C}, t_p = 10\text{ms}$
Non-Repetitive Forward Surge Current (Per Leg)	$I_{FSM}$	140 120	A	$T_C = 25^\circ\text{C}, t_p = 10\text{ms}$ $T_C = 125^\circ\text{C}, t_p = 10\text{ms}$
Power Dissipation (Per Leg)	$P_{tot}$	187	W	$T_C = 25^\circ\text{C}$
Operating Junction and Storage Temperature	$T_J, T_{STG}$	-55 to +175	$^\circ\text{C}$	
TO-247 Mounting Torque M3 Screw	$T_{orq}$	1 8.8	Nm lbf-in	

## 2. Thermal Characteristics

Parameter	Symbol	Values	Unit
Thermal Resistance from Junction to Case(Per Leg)	$R_{\theta JC}$	0.8	$^\circ\text{C}/\text{W}$

### 3. Electrical Characteristics

At  $T_J = 25^\circ\text{C}$ , unless specified otherwise (Per Leg)

Parameter	Symbol	Values			Unit	Test condition
		Min.	Typ.	Max.		
Forward Voltage	$V_F$	/	1.39	1.6	V	$I_F = 20\text{A}, T_J = 25^\circ\text{C}$
			1.65	/		$I_F = 20\text{A}, T_J = 175^\circ\text{C}$
Reverse Current	$I_R$	/	25.6	100	$\mu\text{A}$	$V_R = 650\text{V}, T_J = 25^\circ\text{C}$
			848	/		$V_R = 650\text{V}, T_J = 175^\circ\text{C}$
Total Capacitance	C	/	904	/	pF	$V_R = 0\text{V}, T_J = 25^\circ\text{C}$ f = 1MHz
			96			$V_R = 200\text{V}, T_J = 25^\circ\text{C}$ f = 1MHz
			72			$V_R = 400\text{V}, T_J = 25^\circ\text{C}$ f = 1MHz
Total Capacitive Charge	$Q_C$	/	49.6	/	nC	$V_R = 400\text{V}, I_F = 20\text{A}$ $T_J = 25^\circ\text{C}$
Capacitance Stored Energy	$E_C$	/	5.84	/	$\mu\text{J}$	$V_R = 400\text{V}$

## 4. Typical Performance

At  $T_J = 25^\circ\text{C}$ , unless specified otherwise (Per Leg)

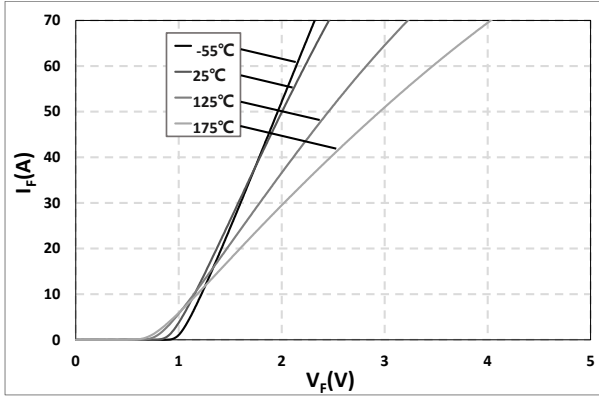

Fig. 1 Typical Forward Characteristics  
 $I_F = f(V_F)$ ;  $T_J = -55^\circ\text{C}, 25^\circ\text{C}, 125^\circ\text{C}, 175^\circ\text{C}$

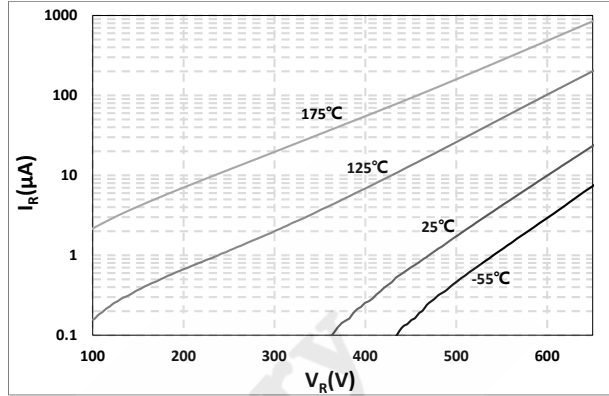

Fig. 2 Reverse Characteristics  
 $I_R = f(V_R)$ ;  $T_J = -55^\circ\text{C}, 25^\circ\text{C}, 125^\circ\text{C}, 175^\circ\text{C}$

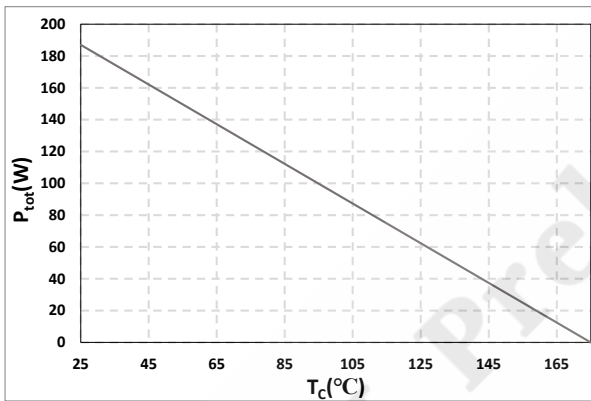

Fig. 3 Typical Power Derating  
 $P_{tot} = f(T_c)$

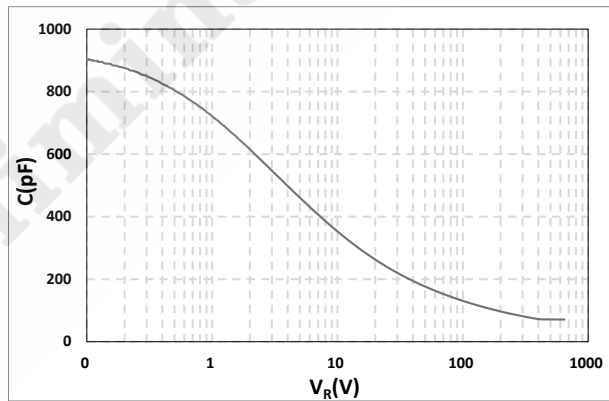

Fig. 4 Typical Total Capacitance  
 $C = f(V_R)$

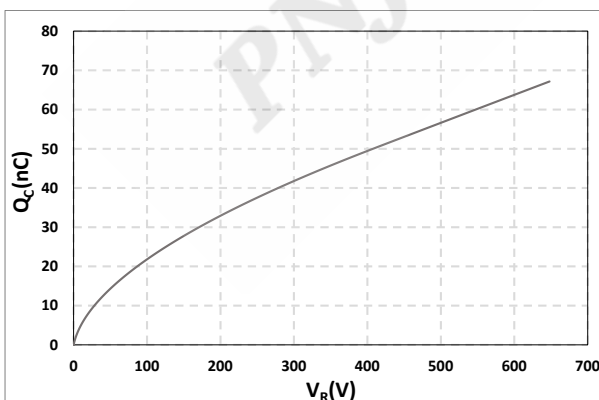

Fig. 5 Typical Total Capacitive Charge  
 $Q_C = f(V_R)$

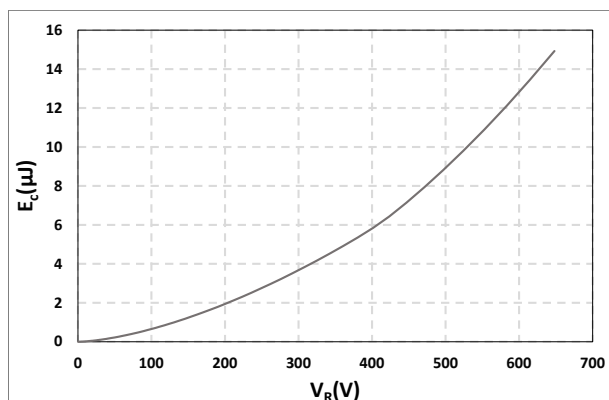
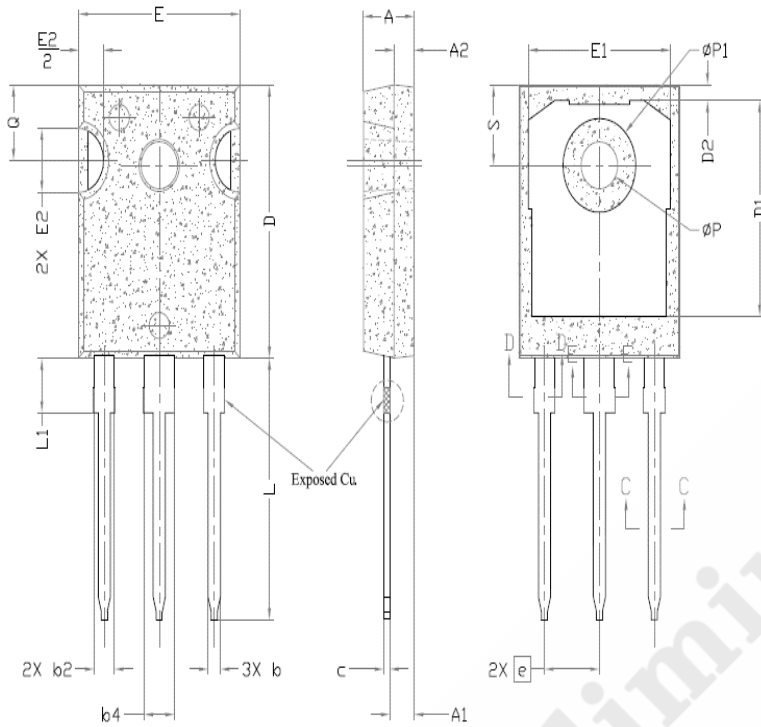

Fig. 6 Capacitance Stored Energy  
 $E_C = f(V_R)$

### 5. Package Outlines



SYMBOL	DIMENSIONS			NOTES
	MIN.	NOM.	MAX.	
A	4.83	5.02	5.21	
A1	2.29	2.41	2.55	
A2	1.50	2.00	2.49	
b	1.12	1.20	1.33	
b1	1.12	1.20	1.28	
b2	1.91	2.00	2.39	6
b3	1.91	2.00	2.34	
b4	2.87	3.00	3.22	6, 8
b5	2.87	3.00	3.18	
c	0.55	0.60	0.69	6
c1	0.55	0.60	0.65	
D	20.80	20.95	21.10	4
D1	16.25	16.55	17.65	5
D2	0.51	1.19	1.35	
E	15.75	15.94	16.13	4
E1	13.46	14.02	14.16	5
E2	4.32	4.91	5.49	3
e	5.44BSC			
L	19.81	20.07	20.32	
L1	4.10	4.19	4.40	6
ØP	3.56	3.61	3.65	7
ØP1	7.19REF.			
Q	5.39	5.79	6.20	
S	6.04	6.17	6.30	

Drawing and Dimensions

PNJ Preliminary



## Important Notice

---

The information given in this document shall in no event be regarded as a guarantee of conditions or characteristics. With respect to any examples, hints or any typical values stated herein and/or any information regarding the application of the product, PN Junction hereby disclaims any and all warranties and liabilities of any kind, including without limitation warranties of non-infringement of intellectual property rights of any third party.

PN Junction reserves the right to make changes at any time to any products or information herein, without notice. “Typical” parameters which may be provided in PN Junction data sheets and/or specifications can and do vary in different applications and actual performance may vary over time. All operating parameters, including “Typical” must be validated for each customer application by customer’s technical experts.

In addition, any information given in this document is subject to customer’s compliance with its obligations stated in this document and any applicable legal requirements, norms and standards concerning customer’s products and any use of the product of PN Junction in customer’s applications. The data contained in this document is exclusively intended for technically trained staff. It is the responsibility of customer’s technical departments to evaluate the suitability of the product for the intended application and the completeness of the product information given in this document with respect to such application.

For further information on the product, technology, delivery terms and conditions and prices please contact your nearest PN Junction office ([www.pnjsemi.com](http://www.pnjsemi.com)).

## Warnings

---

Due to technical requirements products may contain dangerous substances. For information on the types in question please contact your nearest PN Junction office.

Except as otherwise explicitly approved by PN Junction in a written document signed by authorized representatives of PN Junction, PN Junction’s products may not be used in any applications where a failure of the product or any consequences of the use thereof can reasonably be expected to result in personal injury.