

DKSV127

Normally closed, direct lift, 2-way solenoid valve with brass body and 1/2" connections

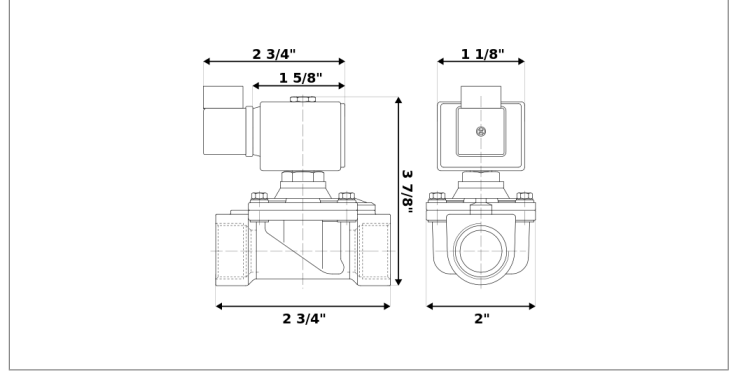

Valve	
Pipe size:	1/2" NPT
Operating pressure:	0–200 psi
Flow coefficient:	2.8 Cv
Media temperature:	15–195 °F
Ambient temperature:	-5–140 °F
Suggested usage:	Air, inert gas, water
Operation:	2-way, normally closed solenoid valve
Mechanism:	Direct lift
Manual override:	No
Pipe gender:	Female
Orifice size:	5/8"
Design pressure:	230 psi
Vacuum rating:	0.001 Torr
Media viscosity:	12 cSt

Materials	
Body:	Brass
Seal:	Buna-N/polyamide rubber (NBR/PA)
Orifice:	Brass
Core tube:	Stainless steel 300
Fixed core:	Stainless steel 400
Plunger:	Stainless steel 400
Spring:	Stainless steel 300
Shading ring:	Copper

Electrical	
Power:	120 V ac
Connection:	Conduit (1/2" NPT)
Holding:	15 VA
Inrush:	25 VA
Voltage tolerances:	+10% -15%
Coil inner diameter:	1/2"
Coil molding:	Polyethylene (PET)
Coil rating:	-5–355 °F (Class H)
Duty cycle:	Continuous, 100% ED
Enclosure:	NEMA 4, IP65

Spare parts		
CORE TUBE	REPAIR KIT	COIL/CONNECTOR
AT-H091	RK-H0Y2	C-B11
		
<ul style="list-style-type: none"> Core tube 	<ul style="list-style-type: none"> O-ring Plunger and diaphragm assembly 	<ul style="list-style-type: none"> 120 V ac electrical coil 1/2" conduit connector