

Item description

Female connector/socket WINSTA® MIDI 5-pole

The WINSTA® MIDI female connector/socket 5-pole is the pluggable solution for your use in control cabinets, on PCBs or for lighting connections. Our pluggable installation connectors with spring pressure connection technology function completely without screw connections. They allow resource-efficient, error-free installation in a large number of possible uses. For greater security in electrical installations, the pluggable installation connector is equipped with mechanical protection against mismatching. The pluggable installation connector offers touch-proof protection with live components in accordance with protection type IP20 (When mated and secured with a strain relief housing: IP2x0 (These compact connectors are not designed for use in open, easily accessible areas!)). L coding identifies WINSTA® MIDI pluggable installation connectors for use in applications related to power supply in automation. This pluggable installation connector can be used for electrical currents up to 25 A. Thus the product is especially suitable for high power loads. The WINSTA® MIDI Pluggable Connection System with Push-in CAGE CLAMP® spring pressure connection technology facilitates precise electrification. Due to the built-in test slot, connections can be checked even when they are plugged in. That saves time and reduces installation labor and expense.

WINSTA® MIDI solutions for your electrical installation – protected against mismatching and maintenance-free

WINSTA® is the pluggable connection system that is perfectly tailored to the strict requirements of electrical installation. It ensures error-free

Subject to changes. Please also observe the further product documentation!



installation of cables and components, quickly and reliably. Now you can also cut installation costs without compromising quality and safety: The WINSTA® MIDI pluggable installation connector with protection type IP20 reduces the need for servicing and prevents unnecessary downtime.

- protection against mismatching eliminates errors
- pre-assembled versions
- with L coding for use in supplying power to power supply units or small servo motors
- custom-engineered solutions
- rapid, structured electrical installation

Data

Electrical data

Ratings per IEC/EN

Ratings per	IEC/EN 60664-1
Nominal voltage (III/3)	400 V
Rated impulse voltage (III/3)	6 kV
Rated current	25 A
Legend (ratings)	(III / 3) ≙ Overvoltage category III / Pollution degree 3

Ratings per UL 1977

Note for the US market	Some versions may also be used for current interruption in accordance with the UL certificate in select applications with currents below 16 A and voltages up to 600 V. For further information, please contact your local sales office.
Rated voltage (UL 1977)	600 V
Rated current UL 1977	23 A

General

Note on contact resistance	approx. 1 mΩ of contact resistance approx. 0.25 mΩ contact transition plug/socket
----------------------------	--

Connection data

Connection points	10
Total number of potentials	5

Subject to changes. Please also observe the further product documentation!



Connection 1

Connection technology	Push-in CAGE CLAMP®
Actuation type	Operating tool Push-in
Nominal cross-section	4 mm ² / 12 AWG
Solid conductor	0.5 ... 4 mm ² / 20 ... 12 AWG
Solid conductor; push-in termination	1.5 ... 4 mm ² / 16 ... 12 AWG
Stranded conductor	0.5 ... 2.5 mm ² / 20 ... 14 AWG
Fine-stranded conductor	0.5 ... 4 mm ² / 20 ... 12 AWG
Fine-stranded conductor; with insulated ferrule	0.25 ... 1.5 mm ² / 20 ... 16 AWG
Fine-stranded conductor; with uninsulated ferrule	0.25 ... 2.5 mm ² / 20 ... 14 AWG
Fine-stranded conductor; with ferrule; push-in termination	1.5 mm ² / 16 AWG
Strip length	9 mm / 0.35 inches
Pole number	5
Conductor entry direction to mating direction	0°

Physical data

Pin spacing	10 mm / 0.394 inches
Width	50 mm / 1.969 inches
Height	12.9 mm / 0.508 inches
Depth	37.5 mm / 1.476 inches

Mechanical Data

Application	Emergency power supply
Coding	L
Variable coding	No
Marking	N $\frac{1}{2}$ L N' L'
Potential marking	N $\frac{1}{2}$ L N' L'
Mating force of a plug-in connection	approx. 20 ... 70 N (depending on pole number)
Retention force of a plug-in connection	Locked: > 80 N
Unmating force of a plug-in connection	Unlocked: approx. 20 ... 70 N (depending on pole number)
Number of mating cycles	200, without resistive load
Protection type	IP20; When mated and secured with a strain relief housing: IP2xC (These compact connectors are not designed for use in open, easily accessible areas!)

Subject to changes. Please also observe the further product documentation!

WAGO GmbH & Co. KG
 Hansastr. 27
 32423 Minden
 Phone: +49571 887-0 | Fax: +49571 887-169
 Email: info.de@wago.com | Web: www.wago.com

Do you have any questions about our products?
 We are always happy to take your call at +49 (571) 887-44222.



Plug-in connection

Contact type (pluggable connector)	Female connector/socket
Connector (connection type)	for conductor
Mismating protection	Yes
Note on mismating protection	All WINSTA [®] components are 100% protected against mismating when: a.) plugging different numbers of poles b.) plugging while rotated 180 c.) plugging while laterally staggered d.) plugging one pole
Locking lever	Can be retrofitted
Locking of plug-in connection	locking lever
Note on locking system	All connectors for mounted installations (snap-in versions for lighting fixtures or devices, all types of PCB and distribution connectors) are factory-equipped with locking levers to ensure plugs and sockets are securely locked. Additional locking levers are only required for flying leads (plug/socket).

Material Data

Note (material data)	Information on material specifications can be found here
Color	dark gray
Cover color	gray
Material group	I
Insulation material	Polyamide (PA66)
Flammability class per UL94	V0
Clamping spring material	Chrome-nickel spring steel (CrNi)
Contact material	Copper or copper alloy; surface-treated
Contact plating	Tin
Fire load	0.303 MJ
Weight	15.7 g

Environmental requirements

Processing temperature	-5 ... +40 °C
Continuous operating temperature	-35 ... +85 °C
Note on continuous operating temperature	Insulating parts for temperatures ≤ 105 °C

Subject to changes. Please also observe the further product documentation!

WAGO GmbH & Co. KG
Hansastr. 27
32423 Minden
Phone: +49571 887-0 | Fax: +49571 887-169
Email: info.de@wago.com | Web: www.wago.com

Do you have any questions about our products?
We are always happy to take your call at +49 (571) 887-44222.

Commercial data



Product Group	20 (Winsta)
eCl@ss 10.0	27-44-06-05
eCl@ss 9.0	27-44-06-05
ETIM 8.0	EC002560
ETIM 7.0	EC002560
PU (SPU)	50 pcs
Packaging type	box
Country of origin	DE
GTIN	4050821064381
Customs tariff number	85366990990

Environmental Product Compliance

RoHS Compliance Status	Compliant, No Exemption
------------------------	-------------------------

Approvals / Certificates

General approvals

Logo	Approval	Additional Approval Text	Certificate name
	CCA DEKRA Certification B.V.	EN 61535	71-123228
	CCA DEKRA Certification B.V.	IEC 61535	NL -84761
	cURus Underwriters Laboratories Inc.	UL 1977	E45171
	VDE VDE Prüf- und Zertifizierungsinstitut	EN 61535	40029808



Declarations of conformity and manufacturer's declarations

Logo	Approval	Additional Approval Text	Certificate name
	EU-Declaration of Conformity WAGO GmbH & Co. KG	-	-





Subject to changes. Please also observe the further product documentation!



Approvals for marine applications

Logo	Approval	Additional Approval Text	Certificate name
	ABS American Bureau of Shipping	-	19- HG1868589- PDA
	DNV GL Det Norske Veritas, Germanischer Lloyd	-	TAE00001Z6
	LR Lloyds Register	IEC 61984	LR22429487TA

Counterpart

	Item no.770-7505 Linect® T-connector; 5-pole; Cod. L; 1 input; 2 outputs; white	www.wago.com/770-7505
	Item no.770-1175 Plug; 5-pole; Cod. L; 4,00 mm ² ; dark gray	www.wago.com/770-1175
	Item no.771-8985/006-103 pre-assembled interconnecting cable; Eca; Socket/plug; 5-pole; Cod. L; H05VV-F 5G 1.5 mm ² ; 1 m; 1,50 mm ² ; dark gray	www.wago.com/771-8985/006-103
	Item no.771-8985/206-103 pre-assembled connecting cable; Eca; Plug/open-ended; 5-pole; Cod. L; H05VV-F 5G 1.5 mm ² ; 1 m; 1,50 mm ² ; dark gray	www.wago.com/771-8985/206-103

Required accessories

Locking levers

Locking system		
	Item no.: 770-121 Locking lever; for flying leads; for manual operation; white	www.wago.com/770-121

Subject to changes. Please also observe the further product documentation!



Item no.: 770-131

Locking lever; for flying leads; for tool operation; white

www.wago.com/770-131



Item no.: 770-101

Locking lever; for flying leads; for manual operation; black

www.wago.com/770-101



Item no.: 770-111

Locking lever; for flying leads; for tool operation; black

www.wago.com/770-111

Strain relief

Strain relief housing



Item no.: 770-505/021-000

Strain relief housing; 5-pole; for 1 cable; 11.5 ... 16.5 mm; 71 mm; black

www.wago.com/770-505/021-000



Item no.: 770-505/023-000

Strain relief housing; 5-pole; for 2 cables; 5.0 ... 9.0 mm; 55 mm; black

www.wago.com/770-505/023-000



Item no.: 770-505

Strain relief housing; 5-pole; for 2 cables; 9.0 ... 13.0 mm; 55 mm; black

www.wago.com/770-505



Item no.: 770-515

Strain relief housing; 5-pole; for 2 cables; 9.0 ... 13.0 mm; 55 mm; white

www.wago.com/770-515



Item no.: 770-515/023-000

Strain relief housing; 5-pole; for 2 cables; 5.0 ... 9.0 mm; 55 mm; white

www.wago.com/770-515/023-000



Item no.: 770-515/021-000

Strain relief housing; 5-pole; for 1 cable; 11.5 ... 16.5 mm; 71 mm; white

www.wago.com/770-515/021-000

Optional accessories

Tool

Wiring aid



Item no.: 770-100

Wiring aid; 2- to 5-pole; Plastic; orange

www.wago.com/770-100

Operating tool

Subject to changes. Please also observe the further product documentation!

WAGO GmbH & Co. KG

Hansastr. 27

32423 Minden

Phone: +49571 887-0 | Fax: +49571 887-169

Email: info.de@wago.com | Web: www.wago.com

Do you have any questions about our products?

We are always happy to take your call at +49 (571) 887-44222.



Item no.: 210-719

Operating tool; Blade: 2.5 x 0.4 mm; with a partially insulated shaft

www.wago.com/210-719

Marking accessories

Marker



Item no.: 770-450/000-002
Marker card; Plastic; yellow

www.wago.com/770-450/000-002



Item no.: 770-450/000-001
Marker card; Plastic; green

www.wago.com/770-450/000-001



Item no.: 770-450/000-005
Marker card; Plastic; red

www.wago.com/770-450/000-005



Item no.: 770-450
Marker card; Plastic; white

www.wago.com/770-450



Item no.: 770-450/000-006
Marker card; Plastic; blue

www.wago.com/770-450/000-006



Item no.: 770-450/000-012
Marker card; Plastic; orange

www.wago.com/770-450/000-012

Cover

Cover



Item no.: 770-201
Lockout cap; 12-pole, separable; for sockets; Plastic; black

www.wago.com/770-201



Item no.: 770-221
Lockout cap; 12-pole, separable; for sockets; Plastic; white

www.wago.com/770-221



Item no.: 897-2005
Protective cap; Type4; for sockets and plugs; PVC; red

www.wago.com/897-2005

Mounting

Subject to changes. Please also observe the further product documentation!

Snap-in frame



Item no.: 770-320

Snap-in frame; 5-pole; 1.0 ... 3.0 mm; black

www.wago.com/770-320



Item no.: 770-321

Snap-in frame; 5-pole; 0.5 ... 2.0 mm; black

www.wago.com/770-321



Item no.: 770-340

Snap-in frame; 5-pole; 1.0 ... 3.0 mm; white

www.wago.com/770-340



Item no.: 770-341

Snap-in frame; 5-pole; 0.5 ... 2.0 mm; white

www.wago.com/770-341

Downloads

Documentation

Bid Text

770-1165 X81 - Datei	2019 Feb 19	xml 3.0 kB	Download
770-1165 doc - Datei	2015 Jun 8	doc 24.1 kB	Download

CAD/CAE-Data

CAE data

WSCAD Universe 770-1165		URL	Download
-------------------------	--	-----	----------

Environmental Product Compliance

Compliance Search

Environmental Product Compliance 770-1165 Socket; 5-pole; Cod. L; 4,00 mm ² ; dark gray		URL	Download
---	--	-----	----------

Subject to changes. Please also observe the further product documentation!

Installation Notes

Conductor termination

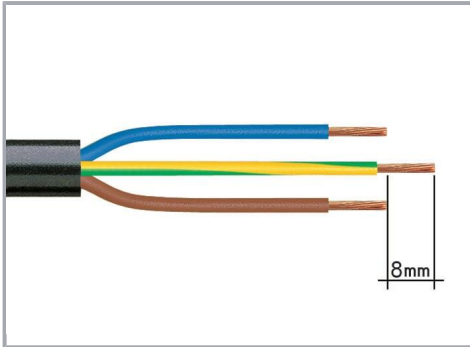

1. Strip length, outer insulation = 35 mm (2-pole), 55 mm (3- to 5-pole)

2. Strip length = 9 mm

3. Extended ground conductor = 8 mm

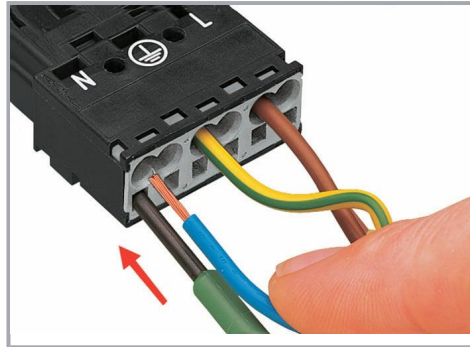

To terminate fine-stranded conductors, open the clamping unit via screwdriver (2.5 mm blade width) and insert a stripped conductor until it hits the backstop.

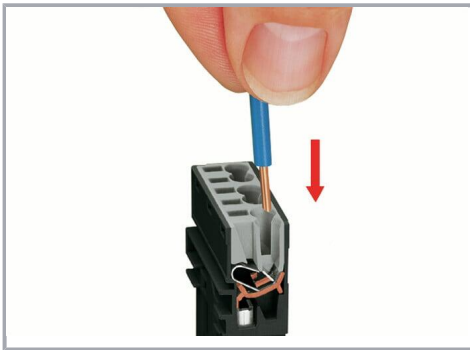

Insert the stripped solid conductor until it hits the backstop.

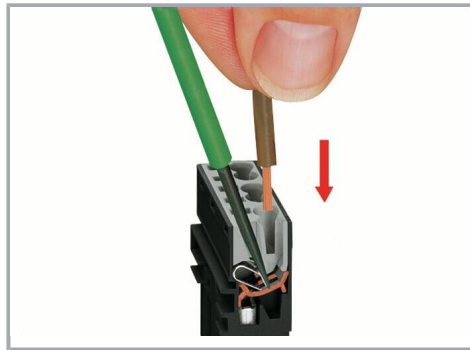

To terminate fine-stranded conductors, open the clamping unit via screwdriver (2.5 mm blade width) and insert a stripped conductor until it hits the backstop.

Conductor removal

Subject to changes. Please also observe the further product documentation!

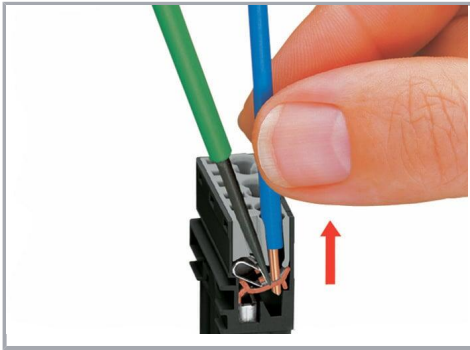

To remove the conductor, actuate the clamp via screwdriver (2.5 mm blade width) and pull out the conductor.

Installation

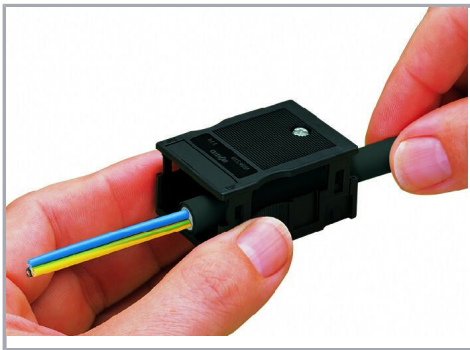

We recommend pulling the pre-latched strain relief housing over the cable prior to termination. However, the strain relief can be mounted at a later time as well.

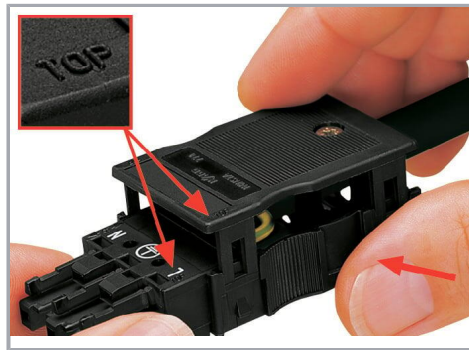

Latch the strain relief housing onto the plug /socket. Note the "TOP" inscription.

Subject to changes. Please also observe the further product documentation!

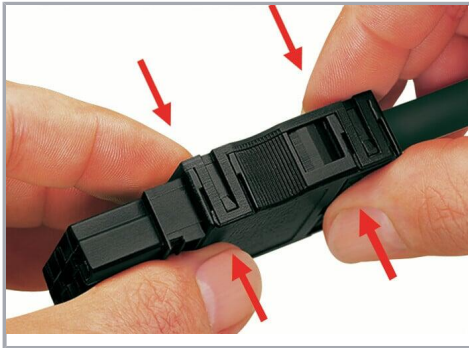

Prepare strain relief housing by snapping together upper and bottom part.



Tighten strain relief screw with screwdriver (2.5 mm blade width).

Product family

WINSTA® MIDI

[Show all products from the family](#)

Subject to changes. Please also observe the further product documentation!