

NVC6S5A444NLZ

Power MOSFET

60 V, 78 mΩ, 4.5 A, N-Channel

Automotive Power MOSFET designed to minimize gate charge and low on resistance. AEC-Q101 qualified MOSFET and PPAP capable suitable for automotive applications.

Features

- 4.5 V Drive
- High ESD Protection
- Low On-Resistance
- CPH6 Package is Pin-Compatible with SOT-26
- Pb-Free, Halogen Free and RoHS Compliance

Typical Applications

- Load Switch
- Motor Drive

Specifications

ABSOLUTE MAXIMUM RATINGS (T_a = 25°C)

Parameter	Symbol	Value	Unit
Drain to Source Voltage	V _{DSS}	60	V
Gate to Source Voltage	V _{GSS}	±20	V
Drain Current (DC) (Note 1)	I _D	4.5	A
Drain Current (DC) (Note 2)		3.5	A
Drain Current (Pulse) PW ≤ 10 μs, duty cycle ≤ 1%	I _{DP}	18	A
Power Dissipation T _a = 25°C (Note 1)	P _D	1.9	W
Power Dissipation T _a = 25°C (Note 2)		0.97	W
Junction Temperature and Storage Temperature	T _J , T _{stg}	-55 to +175	°C

Stresses exceeding those listed in the Maximum Ratings table may damage the device. If any of these limits are exceeded, device functionality should not be assumed, damage may occur and reliability may be affected.

THERMAL RESISTANCE MAXIMUM RATINGS

Parameter	Symbol	Value	Unit
Junction to Ambient	(Note 1)	R _{θJA}	78.1 °C/W
	(Note 2)		153 °C/W

1. Surface mounted on ceramic substrate (900 mm² × 0.8 mm).
2. Surface mounted on FR4 board using a 92 mm², 1 oz. Cu pad.



ON Semiconductor®

www.onsemi.com

V _{DSS}	R _{DS(on)} MAX	I _D MAX
60 V	78 mΩ @ 10 V	4.5 A
	120 mΩ @ 4.5 V	

ELECTRICAL CONNECTION N-Channel

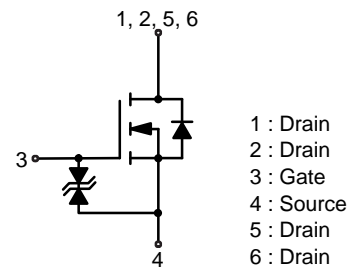

MARKING DIAGRAM

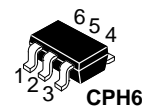

CASE 318BD

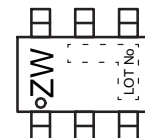

ORDERING INFORMATION

See detailed ordering, marking and shipping information in the package dimensions section on page 5 of this data sheet.

NVC6S5A444NLZ

ELECTRICAL CHARACTERISTICS ($T_a = 25^\circ\text{C}$)

Parameter	Symbol	Conditions	Min	Typ	Max	Unit
Drain to Source Breakdown Voltage	$V_{(BR)DSS}$	$I_D = 1 \text{ mA}$, $V_{GS} = 0 \text{ V}$	60	–	–	V
Zero-Gate Voltage Drain Current	I_{DSS}	$V_{DS} = 60 \text{ V}$, $V_{GS} = 0 \text{ V}$	–	–	1.0	μA
Gate to Source Leakage Current	I_{GSS}	$V_{GS} = \pm 16 \text{ V}$, $V_{DS} = 0 \text{ V}$	–	–	± 10	μA
Gate Threshold Voltage	$V_{GS(th)}$	$V_{DS} = 10 \text{ V}$, $I_D = 1 \text{ mA}$	1.2	–	2.6	V
Forward Transconductance	g_{FS}	$V_{DS} = 10 \text{ V}$, $I_D = 2 \text{ A}$	–	3.0	–	S
Static Drain to Source On-State Resistance	$R_{DS(on)}$	$I_D = 2 \text{ A}$, $V_{GS} = 10 \text{ V}$	–	60	78	$\text{m}\Omega$
		$I_D = 1 \text{ A}$, $V_{GS} = 4.5 \text{ V}$	–	84	120	$\text{m}\Omega$
Input Capacitance	C_{iss}	$V_{DS} = 20 \text{ V}$, $f = 1 \text{ MHz}$	–	505	–	pF
Output Capacitance	C_{oss}		–	57	–	pF
Reverse Transfer Capacitance	C_{rss}		–	37	–	pF
Turn-ON Delay Time	$t_d(on)$	See Figure 1	–	7.3	–	ns
Rise Time	t_r		–	9.8	–	ns
Turn-OFF Delay Time	$t_d(off)$		–	40	–	ns
Fall Time	t_f		–	24	–	ns
Total Gate Charge	Q_g	$V_{DS} = 30 \text{ V}$, $V_{GS} = 10 \text{ V}$, $I_D = 4.5 \text{ A}$	–	10	–	nC
Gate to Source Charge	Q_{gs}		–	1.6	–	nC
Gate to Drain "Miller" Charge	Q_{gd}		–	2.1	–	nC
Forward Diode Voltage	V_{SD}	$I_S = 4.5 \text{ A}$, $V_{GS} = 0 \text{ V}$	–	0.86	1.2	V

Product parametric performance is indicated in the Electrical Characteristics for the listed test conditions, unless otherwise noted. Product performance may not be indicated by the Electrical Characteristics if operated under different conditions.

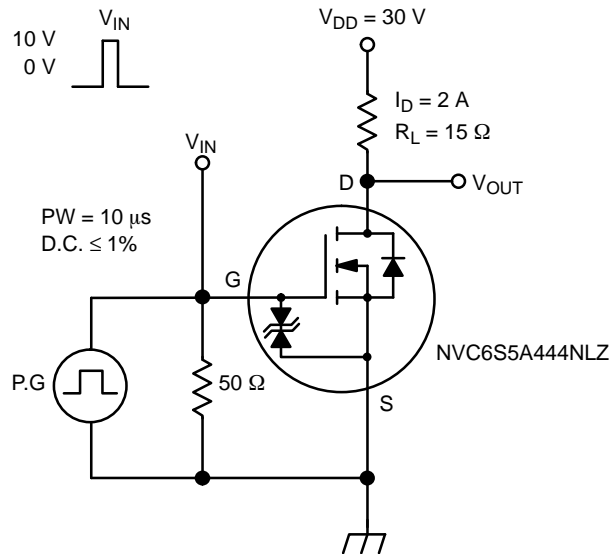

Figure 1. Switching Time Test Circuit

NVC6S5A444NLZ

TYPICAL CHARACTERISTICS

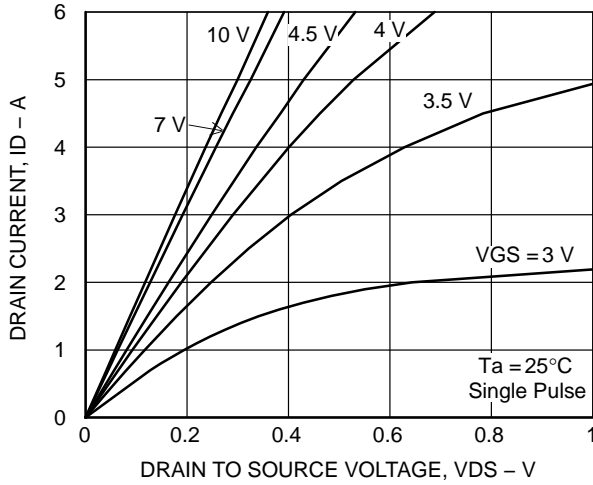

Figure 2. $I_D - V_{DS}$

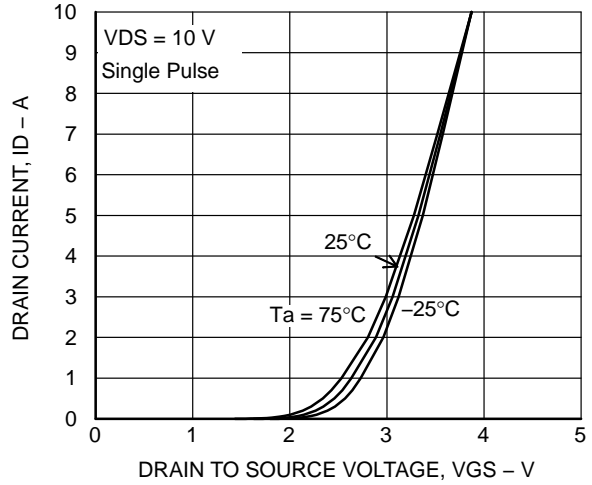

Figure 3. $I_D - V_{GS}$

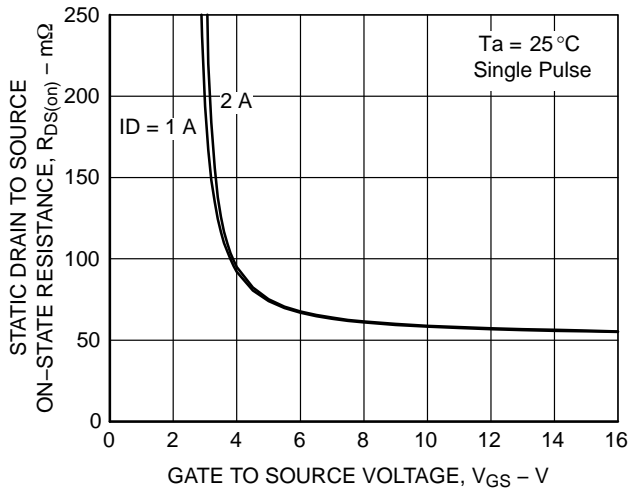

Figure 4. $R_{DS(on)} - V_{GS}$

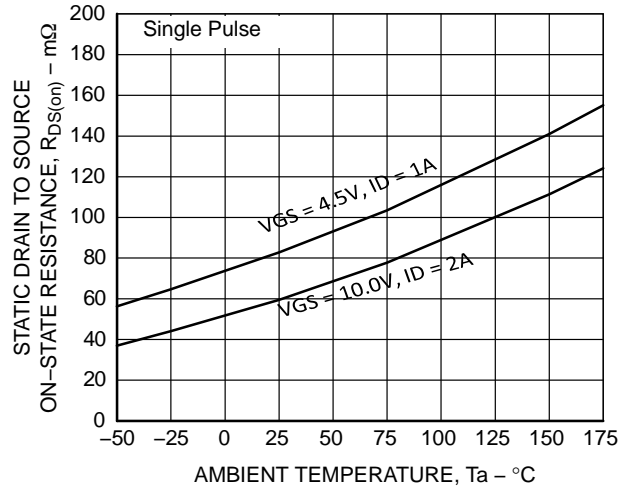

Figure 5. $R_{DS(on)} - T_a$

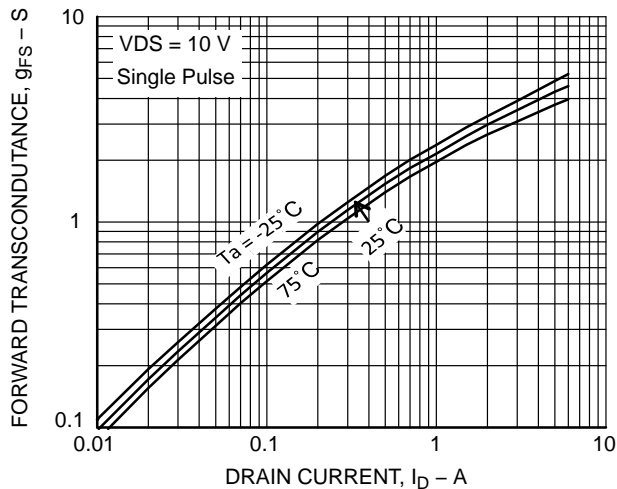

Figure 6. $g_{FS} - I_D$

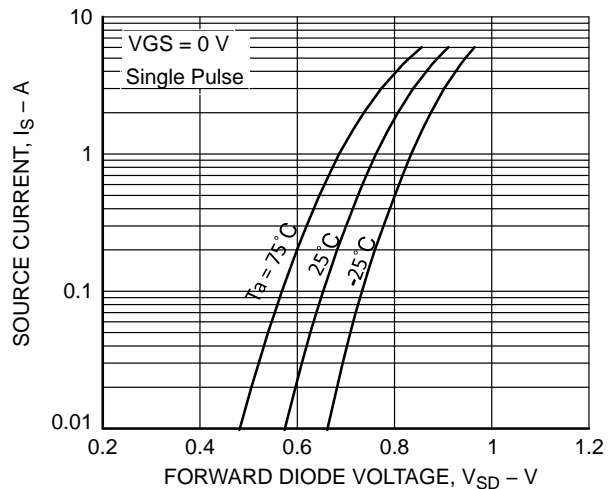

Figure 7. $I_S - V_{SD}$

NVC6S5A444NLZ

TYPICAL CHARACTERISTICS

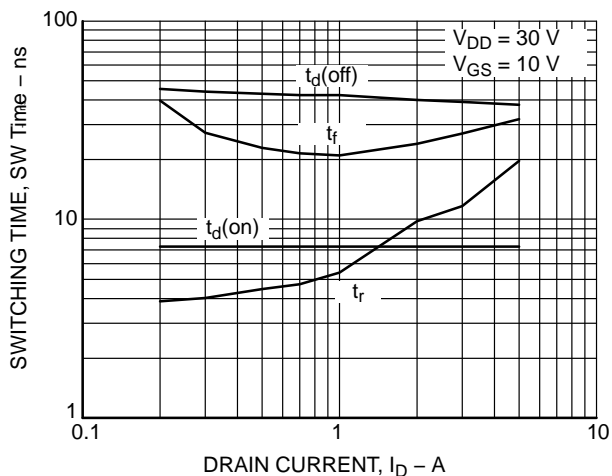

Figure 8. SW TIME - I_D

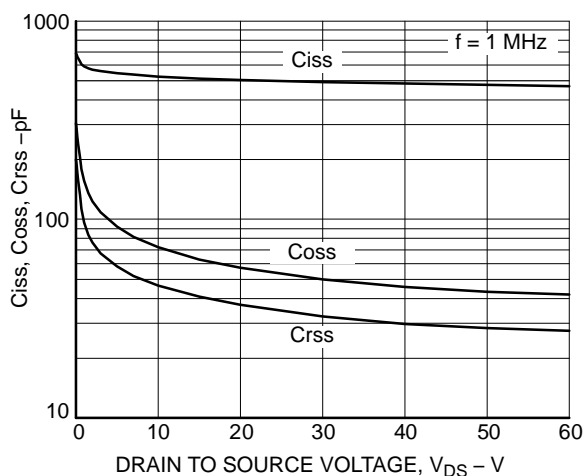

Figure 9. C_{iss} , C_{oss} , C_{rss} - V_{DS}

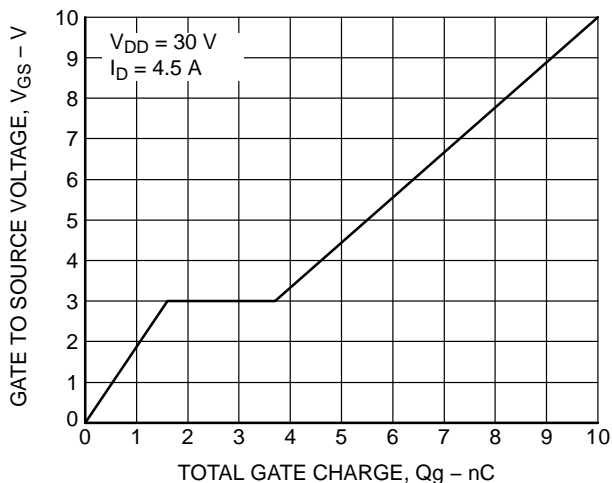

Figure 10. V_{GS} - Q_g

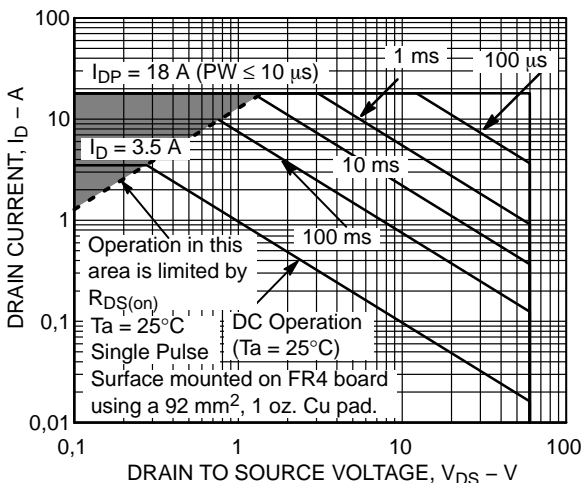

Figure 11. SOA

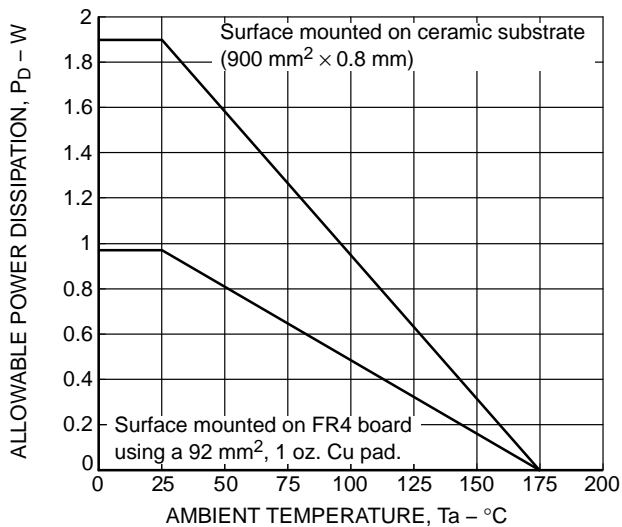

Figure 12. P_D - T_a

NVC6S5A444NLZ

TYPICAL CHARACTERISTICS

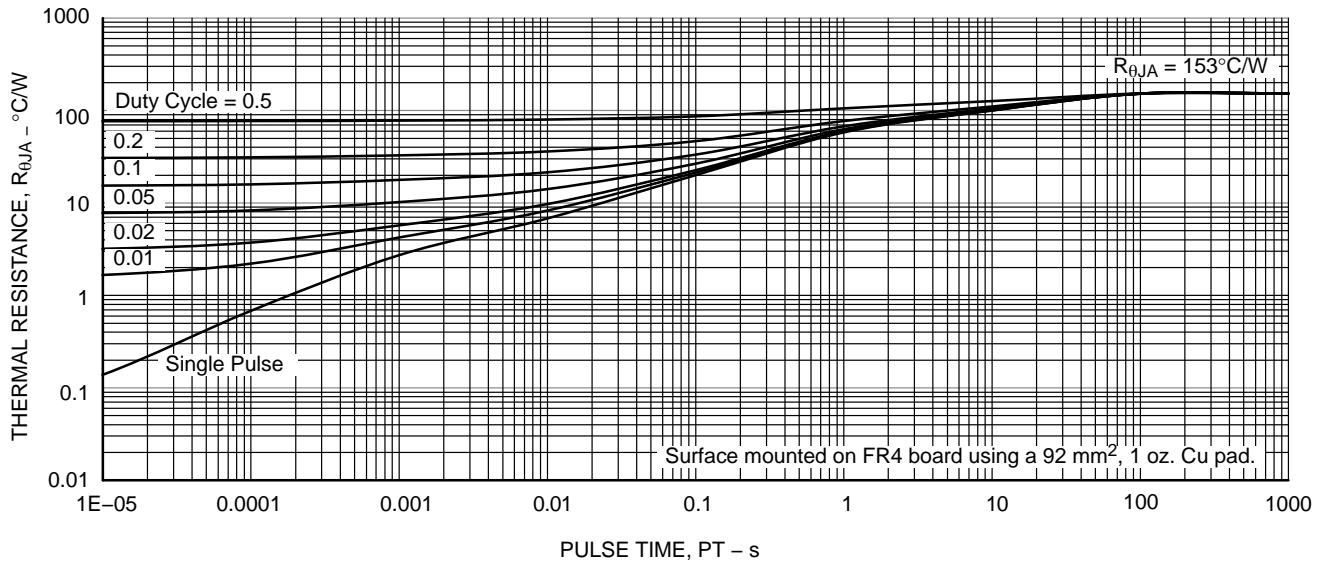

Figure 13. $R_{\theta JA}$ – PULSE TIME

DEVICE ORDERING INFORMATION

Device	Marking	Package	Shipping†
NVC6S5A444NLZT1G	ZW	CPH6 (Pb-Free / Halogen Free)	3,000 / Tape & Reel
NVC6S5A444NLZT2G			

†For information on tape and reel specifications, including part orientation and tape sizes, please refer to our Tape and Reel Packaging Specifications Brochure, BRD8011/D.

Since the NVC6S5A444NLZ is a MOSFET product, please avoid using this device in the vicinity of highly charged objects.

MECHANICAL CASE OUTLINE
PACKAGE DIMENSIONS

CPH6
CASE 318BD
ISSUE O

DATE 30 NOV 2011

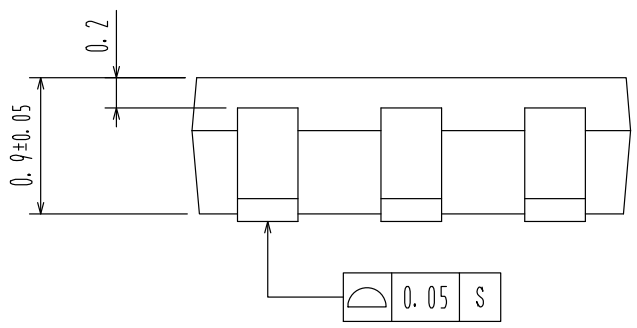
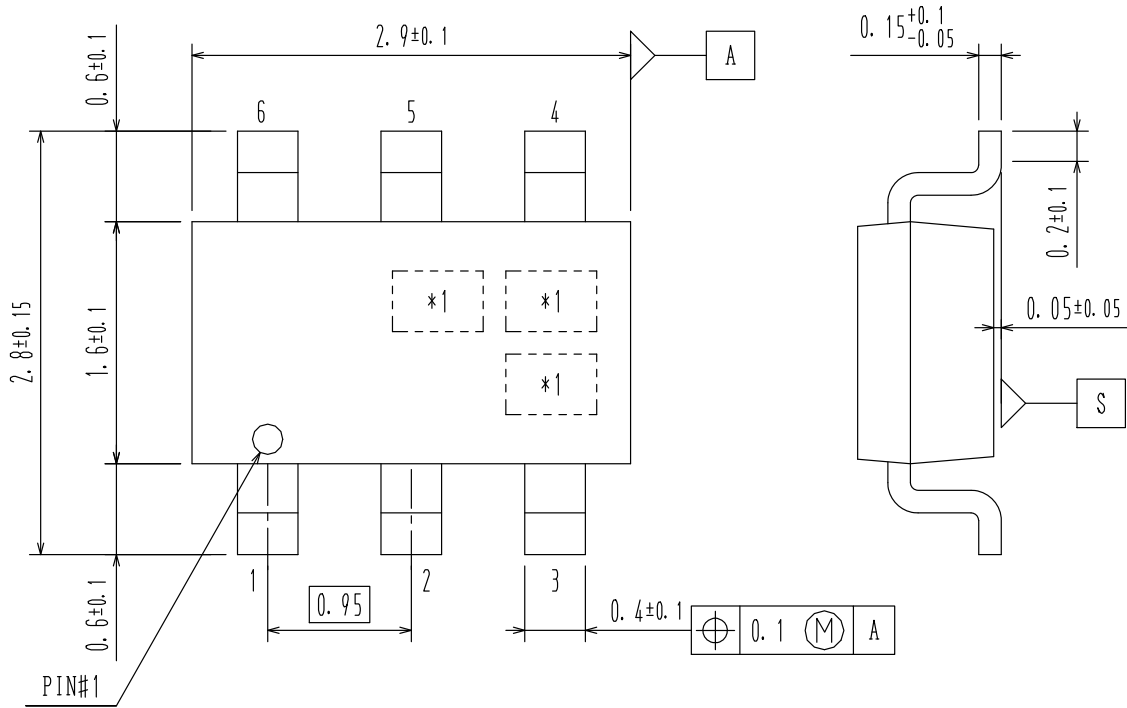

DOCUMENT NUMBER:	98AON65440E	Electronic versions are uncontrolled except when accessed directly from the Document Repository. Printed versions are uncontrolled except when stamped "CONTROLLED COPY" in red.
DESCRIPTION:	CPH6	PAGE 1 OF 1

ON Semiconductor and **ON** are trademarks of Semiconductor Components Industries, LLC dba ON Semiconductor or its subsidiaries in the United States and/or other countries. ON Semiconductor reserves the right to make changes without further notice to any products herein. ON Semiconductor makes no warranty, representation or guarantee regarding the suitability of its products for any particular purpose, nor does ON Semiconductor assume any liability arising out of the application or use of any product or circuit, and specifically disclaims any and all liability, including without limitation special, consequential or incidental damages. ON Semiconductor does not convey any license under its patent rights nor the rights of others.

onsemi, **Onsemi**, and other names, marks, and brands are registered and/or common law trademarks of Semiconductor Components Industries, LLC dba "**onsemi**" or its affiliates and/or subsidiaries in the United States and/or other countries. **onsemi** owns the rights to a number of patents, trademarks, copyrights, trade secrets, and other intellectual property. A listing of **onsemi**'s product/patent coverage may be accessed at www.onsemi.com/site/pdf/Patent-Marking.pdf. **onsemi** reserves the right to make changes at any time to any products or information herein, without notice. The information herein is provided "as-is" and **onsemi** makes no warranty, representation or guarantee regarding the accuracy of the information, product features, availability, functionality, or suitability of its products for any particular purpose, nor does **onsemi** assume any liability arising out of the application or use of any product or circuit, and specifically disclaims any and all liability, including without limitation special, consequential or incidental damages. Buyer is responsible for its products and applications using **onsemi** products, including compliance with all laws, regulations and safety requirements or standards, regardless of any support or applications information provided by **onsemi**. "Typical" parameters which may be provided in **onsemi** data sheets and/or specifications can and do vary in different applications and actual performance may vary over time. All operating parameters, including "Typicals" must be validated for each customer application by customer's technical experts. **onsemi** does not convey any license under any of its intellectual property rights nor the rights of others. **onsemi** products are not designed, intended, or authorized for use as a critical component in life support systems or any FDA Class 3 medical devices or medical devices with a same or similar classification in a foreign jurisdiction or any devices intended for implantation in the human body. Should Buyer purchase or use **onsemi** products for any such unintended or unauthorized application, Buyer shall indemnify and hold **onsemi** and its officers, employees, subsidiaries, affiliates, and distributors harmless against all claims, costs, damages, and expenses, and reasonable attorney fees arising out of, directly or indirectly, any claim of personal injury or death associated with such unintended or unauthorized use, even if such claim alleges that **onsemi** was negligent regarding the design or manufacture of the part. **onsemi** is an Equal Opportunity/Affirmative Action Employer. This literature is subject to all applicable copyright laws and is not for resale in any manner.

ADDITIONAL INFORMATION

TECHNICAL PUBLICATIONS:

Technical Library: www.onsemi.com/design/resources/technical-documentation
onsemi Website: www.onsemi.com

ONLINE SUPPORT: www.onsemi.com/support

For additional information, please contact your local Sales Representative at www.onsemi.com/support/sales