



**Specific Lighting
Product Data Sheet**
LTW-5630SP660

Spec No. :DS23-2016-0139
Effective Date: 02/16/2017
Revision: A

LITE-ON DCC

RELEASE

BNS-OD-FC001/A4

Specific Lighting LTW-5630SP660

1. Description

The LiteON 5630 Product series is a wide beam angle standard-dimension package, combining the lifetime and reliability advantages of Light Emitting Diodes with the brightness of conventional lighting. It gives you total design freedom and unmatched brightness, creating a new opportunities for solid state lighting to displace conventional lighting technologies.

1.1 Features

- Package in 8mm tape on 7" diameter reels.
- Compatible with automatic placement equipment.
- Compatible with infrared and vapor phase reflow solder process.
- EIA STD package.
- I.C. compatible.
- Meet green product and Pb-free(According to RoHS)

Specific Lighting
LTW-5630SP660

2. Outline Dimensions

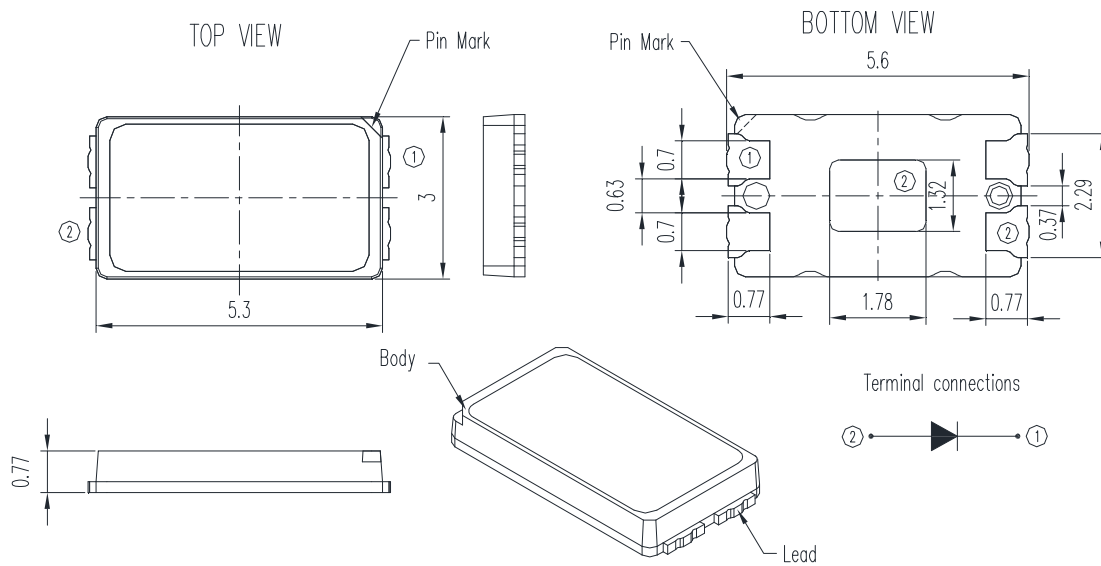

Part No.	Lens Color	Source Color
LTW-5630SP660	Clean	AllnGaP RED

Notes:

1. All dimensions are in millimeters.
2. Tolerance is ± 0.2 mm (.008") unless otherwise noted.

**Specific Lighting
LTW-5630SP660**

3. Absolute Maximum Ratings at $T_a=25^{\circ}\text{C}$

Parameter	Symbol	Rating	Unit
DC Forward Current	I_F	200	mA
Pulsed Forward Current (*1)	I_{FP}	300	mA
Power Dissipation	P_D	470	mW
Operating Temperature	T_{opr}	-40~+85	$^{\circ}\text{C}$
Storage Temperature	T_{stg}	-40~+100	$^{\circ}\text{C}$
Dice Temperature	T_j	110	$^{\circ}\text{C}$

Notes :

1. 1/10 duty cycle, Pulse width 10msec.

Specific Lighting LTW-5630SP660

4. Electro-Optical Characteristics

4.1 Typical Performance

Parameter	Symbol	Values		Unit	Test Condition
Radiant Flux	Φ_e	Min	110	mW	$I_F = 150\text{mA}$
		Typ.	127		
		Max.	177		
Luminous Flux	Φ_v	Typ.	8.17	lm	
Photon Flux	PPF	Typ.	0.695	$\mu\text{ mol/s}$	
Peak Wavelength	W_P	Min	650	nm	
		Typ.	660		
		Max.	670		
Dominant Wavelength	W_d	Typ.	642	nm	
Spectral Line Half-width	$\Delta\lambda$	Typ.	20	nm	
Viewing angle	$2\theta_{1/2}$	Typ.	120	deg	
Forward Voltage	V_F	Min	2.0	V	
		Typ.	2.2		
		Max.	2.8		
Reverse Current	I_R	Max.	5	μA	$V_R = -10\text{V}$

Notes

1. Radiant flux and Peak Wavelength are the total flux output as measured with an integrating sphere.
2. Radiant flux, Peak Wavelength and Forward Voltage classification code are marked on each packing bag.
3. CAS-140B is the test standard for Radiant flux, Peak Wavelength and Forward Voltage.

**Specific Lighting
LTW-5630SP660**

4.2 Typical Electrical / Optical Characteristics Curves

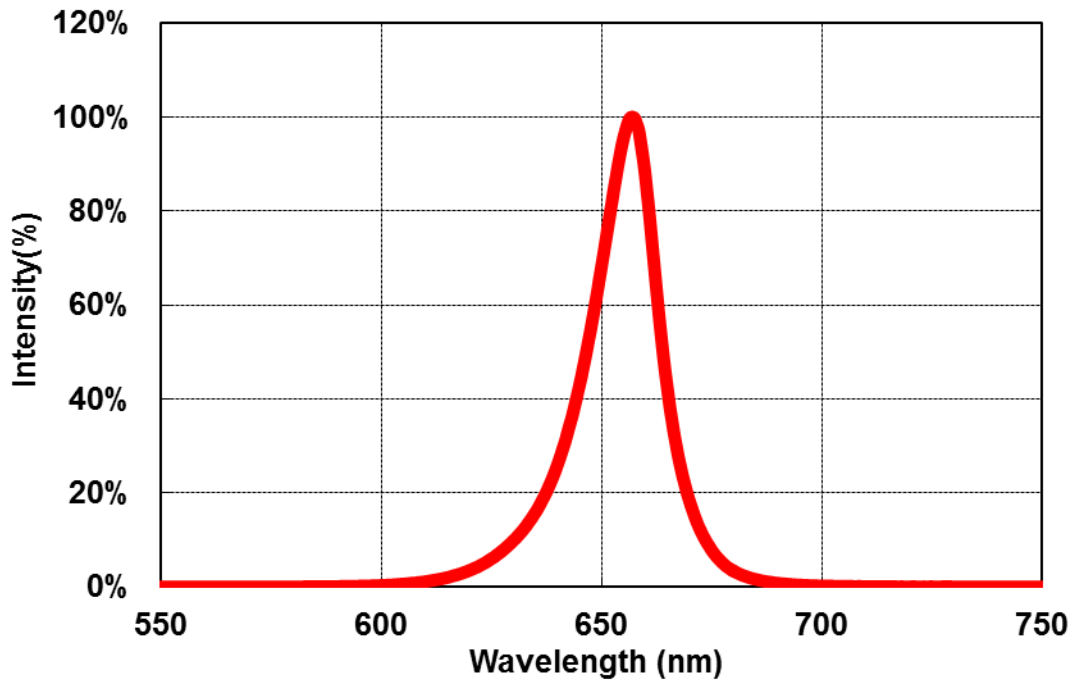

Fig1. Relative Spectrum of Emission

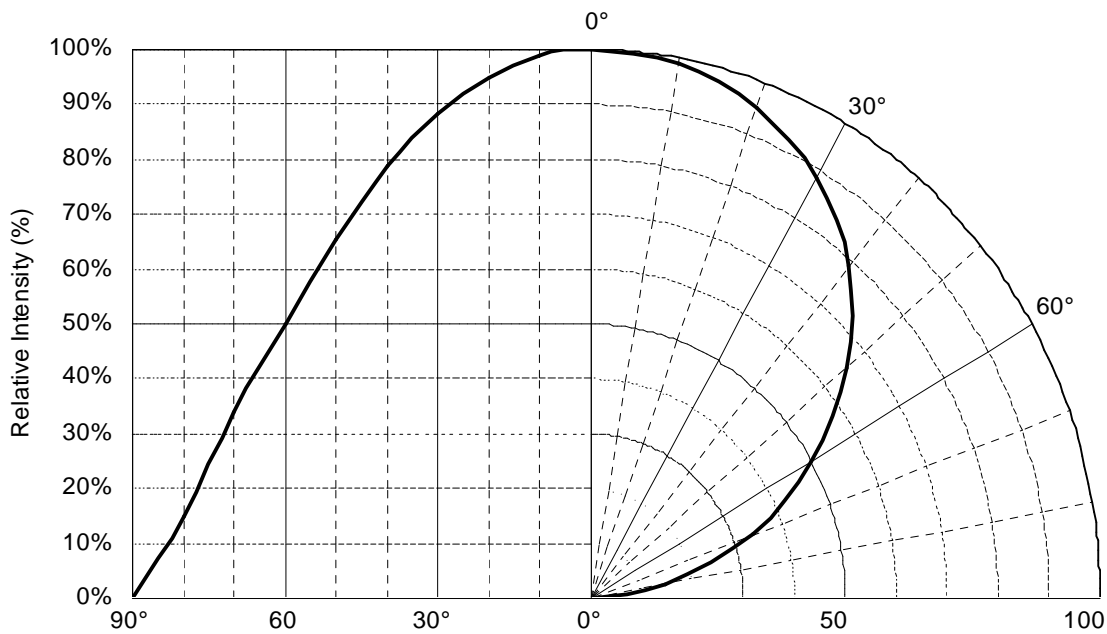

Fig2. Radiation Characteristics

**Specific Lighting
LTW-5630SP660**

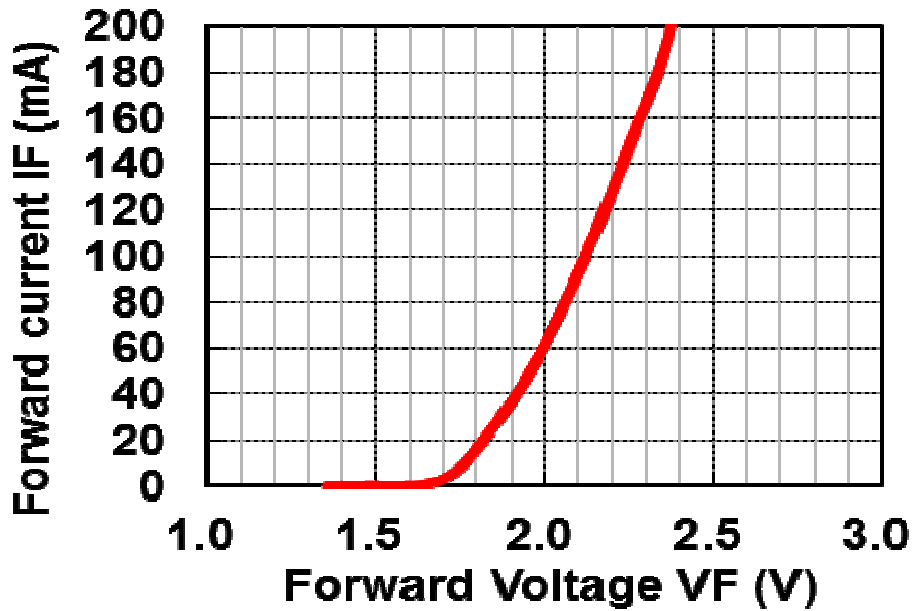

Fig3. Voltage vs. Forward Current

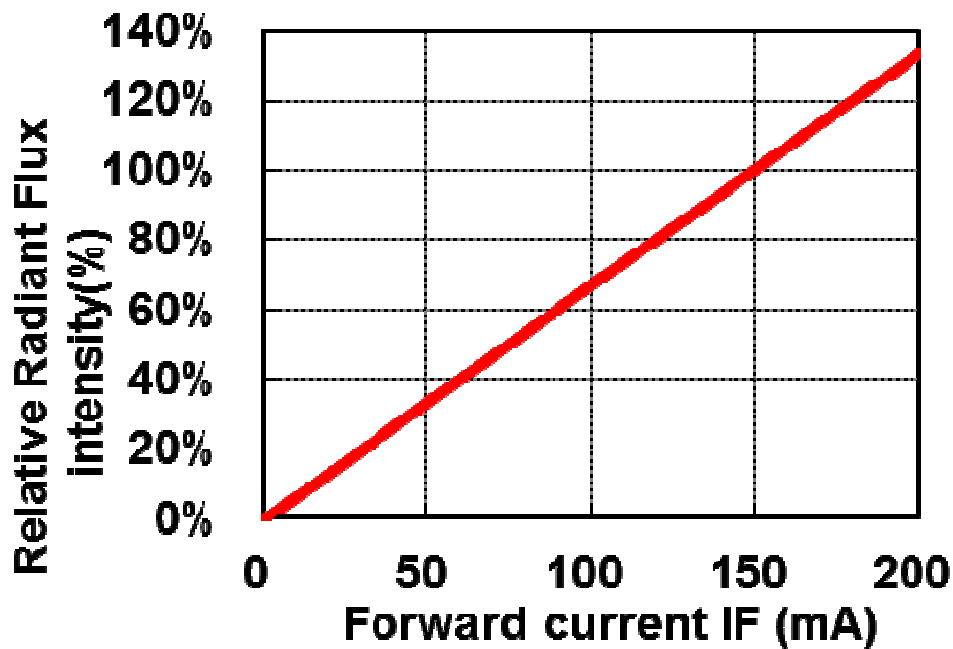

Fig.4. Forward Current vs. Relative Radiant Flux

Specific Lighting
LTW-5630SP660

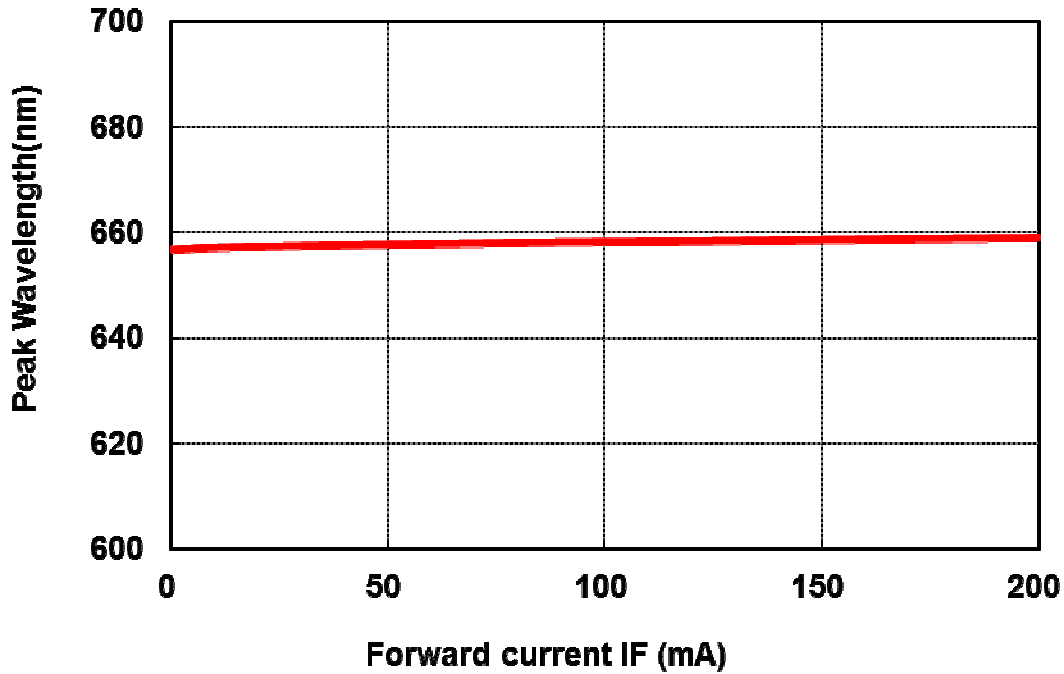

Fig.5. Forward Current vs. Peak Wavelength

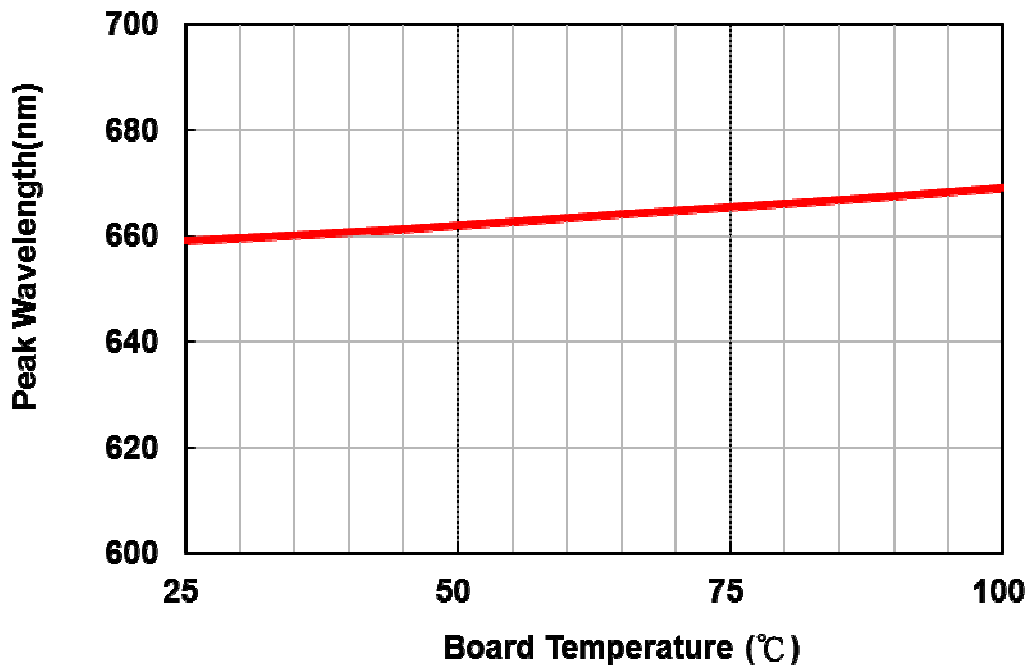

Fig.6. Board Temperature vs. Peak Wavelength

Specific Lighting
LTW-5630SP660

5. Bin Code List

Forward Voltage Spec. Table		
V _F Bin	IF =150mA, Ta=25°C	
	Min	Max
3	2.0	2.2
4	2.2	2.4
5	2.4	2.6
6	2.6	2.8

Radiant flux (mW) Table		
mW Bin	IF =150mA, Ta=25°C	
	Min	Max
R5	110	121
R6	121	133
R7	133	146
R8	146	161
R9	161	177

Peak Wavelength Spec. Table		
W _P Bin	IF =150mA, Ta=25°C	
	Min	Max
P7	650	655
P8	655	660
P9	660	665
P10	665	670

Notes

1. The flux is operated performance with forward current 150mA per die.
2. Flux is the total luminous flux output as initial measured with an integrated sphere.
3. Forward Voltage (V_F) measurement allowance is ±0.1V.
4. Flux measurement allowance is ±10%.
5. Wavelength allowance is ±5nm

**Specific Lighting
LTW-5630SP660**

※ **Notes: Full Rank on Label**

Example: 4/R6/P7

Forward Voltage Rank	Radiant flux Rank	Peak Wavelength Rank
4	R6	P7

Specific Lighting
LTW-5630SP660

6. Reflow Soldering Characteristics

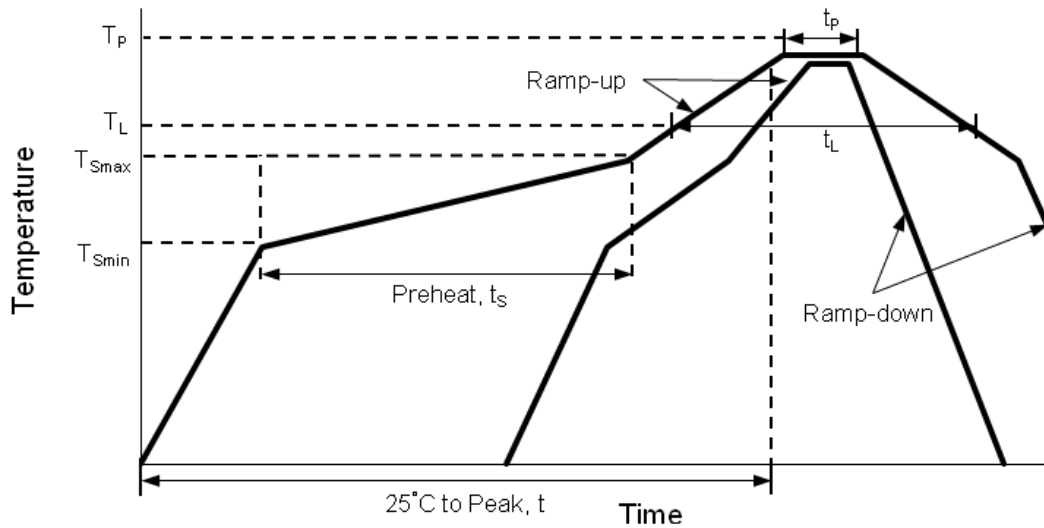

Profile Feature	Lead Free Assembly
Average Ramp-Up Rate (T_{Smax} to T_P)	3°C / second max
Preheat Temperature Min (T_{Smin})	150°C
Preheat Temperature Max (T_{Smax})	200°C
Preheat Time (t_{smin} to t_{smax})	60 – 180 seconds
Time Maintained Above Temperature (T_L)	217°C
Time Maintained Above Time (t_L)	60 – 150 seconds
Peak / Classification Temperature (T_P)	260°C
Time Within 5°C of Actual Peak Temperature (t_p)	5 seconds
Ramp – Down Rate	6°C / second max
Time 25°C to Peak Temperature	8 minutes max

Specific Lighting LTW-5630SP660

Notes:

1. The LEDs can be soldered using the reflow soldering or hand soldering method. The recommended hand soldering condition is 350 °C max. and 2 secs max. for one time only, and the recommended reflow soldering condition is 260 °C max. and 5 secs max. for three times max.
2. All temperatures refer to topside of the package, measured on the package body surface.
3. The soldering condition referring to J-STD-020B. The storage ambient for the LEDs should not exceed 30 °C temperature or 70% relative humidity. It is recommended that LEDs out of their original packaging are soldered within one week. For extended storage out of their original packaging, it is recommended that the LEDs were stored in a sealed container with appropriate desiccant, or desiccators with nitrogen ambient. If the LEDs were unpacked more than 168hrs, baking the LEDs at 60 °C for 24hrs before soldering process.
4. The soldering profile could be further referred to different soldering grease material characteristic. The grease vendor will provide this information.
5. A rapid-rate process is not recommended for the LEDs cooling down from the peak temperature.
6. Although the recommended reflow conditions are specified above, the reflow or hand soldering condition at the lowest possible temperature is desirable for the LEDs.
7. LiteOn cannot make a guarantee on the LEDs which have been already assembled using the dip soldering method.

Specific Lighting LTW-5630SP660

7. Reliability Test

No	Test item	Test Condition	Duration	Number of Damaged
1	Operating Test	Ta=25°C, IF=150mA	1,000hrs	0/20
2	High Temp. Operating Test	Ta=85°C, IF=150mA	1,000hrs	0/20
3	High Humidity Operating Test	Ta=85°C, RH=85%, IF=150mA	1,000hrs	0/20
4	Low Temp. Operating Test	Ta=-40°C, IF=150mA	1,000hrs	0/20
5	High Temp. Storage Test	Ta=100°C	1,000hrs	0/20
6	Low Temp. Storage Test	Ta=-40°C	1,000hrs	0/20
7	High Humidity .Storage Test	Ta=60°C, RH=90%	1,000hrs	0/20
8	Temperature Cycle Test	Ta= -40°C, 30min . ~25°C, 5min . ~100°C, 30min .	100 cycle	0/20
9	Resistance to Soldering Heat (Reflow Soldering)	Tsld=260°C , 10sec	2 times	0/20

■ Criteria for Judging the Damage

Item	Symbol	Test Condition	Criteria for Judgment	
			Min.	Max.
Forward Voltage	V _F	I _F =150 mA	-	Initial Value x1.1
Radiant flux	Φ _e	I _F =150 mA	Initial Value x0.7	—
Reverse Current	I _R	V _R =-10V	-	5μA

Specific Lighting LTW-5630SP660

8. User Guide

■ Cleaning

Do not use unspecified chemical liquid to clean LED they could harm the package. If cleaning is necessary, immerse the LED in ethyl alcohol or isopropyl alcohol at normal temperature for less than one minute.

■ Recommend Printed Circuit Board Attachment Pad

Infrared / vapor phase

Reflow Soldering

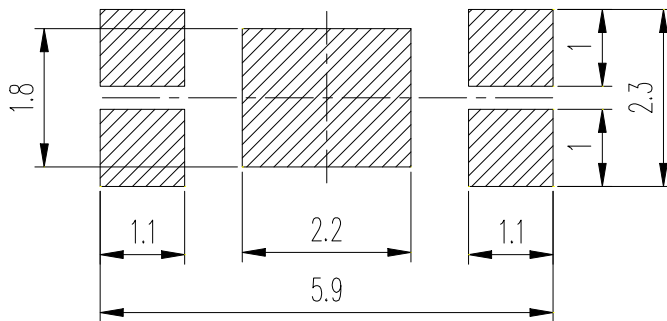

■ Package Dimensions of Tape

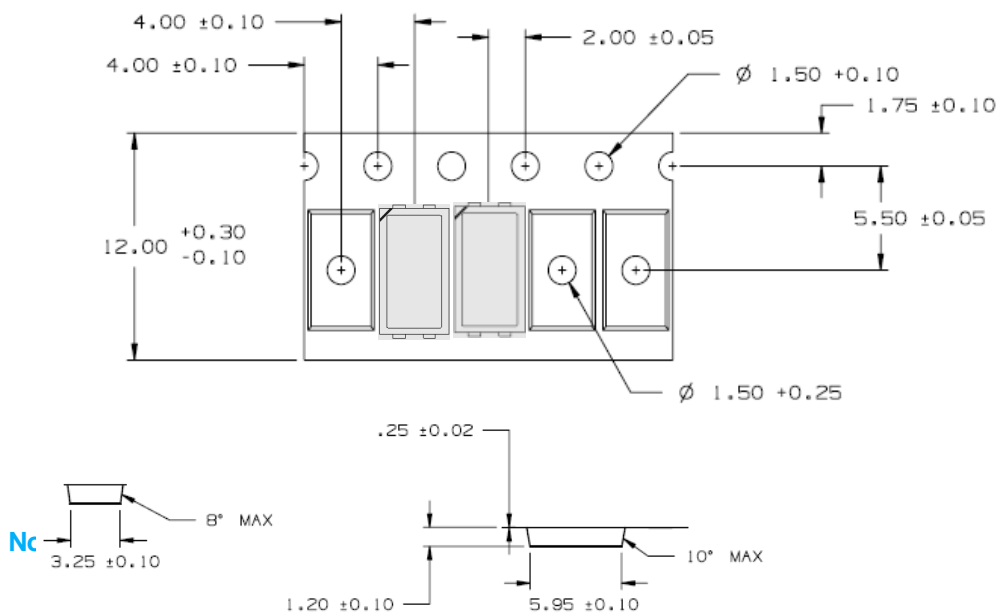



**Specific Lighting
LTW-5630SP660**

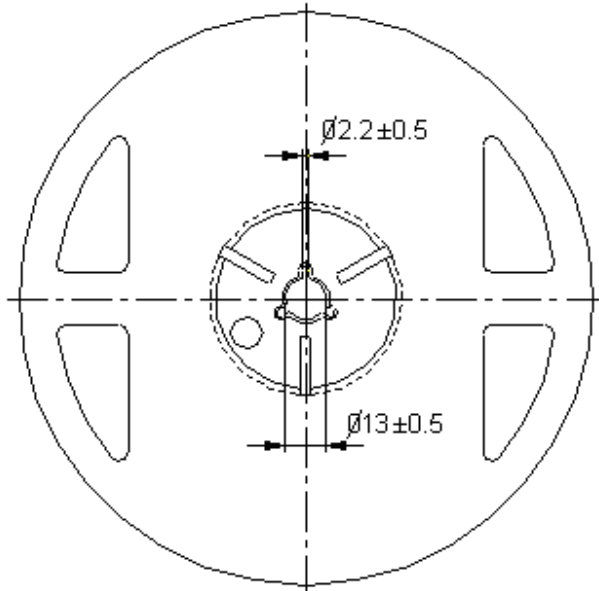

Note: 01. The tolerance unless mentioned is ± 0.1 mm
02. The measured unit is "mm"

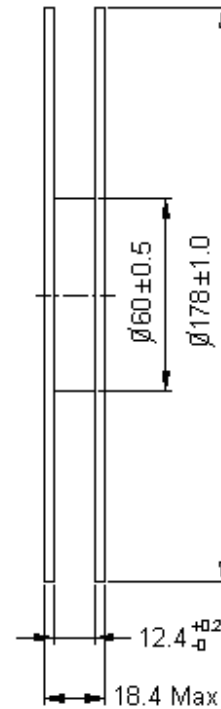

Notes:

1. Empty component pockets sealed with top cover tape.
2. 7 inch reel-3000 pieces per reel.
3. Minimum packing quantity is 500 pieces for remainders.
4. The maximum number of consecutive missing lamps is two.
5. In accordance with EIA-481-1-B specifications.

Specific Lighting LTW-5630SP660

9. Cautions

9.1 Application

The LEDs described here are intended to be used for ordinary electronic equipment (such as office equipment, communication equipment and household applications). Consult Liteon's Sales in advance for information on applications in which exceptional reliability is required, particularly when the failure or malfunction of the LEDs may directly jeopardize life or health (such as in aviation, transportation, traffic control equipment, medical and life support systems and safety devices).

9.2 Storage

This product is qualified as Moisture sensitive Level 3 per JEDEC J-STD-020 Precaution when handling this moisture sensitive product is important to ensure the reliability of the product.

The package is sealed:

The LEDs should be stored at 30°C or less and 90%RH or less. And the LEDs are limited to use within one year, while the LEDs is packed in moisture-proof package with the desiccants inside.

The package is opened:

The LEDs should be stored at 30°C or less and 60%RH or less. Moreover, the LEDs are limited to solder process within 168hrs. If exceeding the storage limiting time since opened, that we recommended to baking LEDs at 60°C at least 24hrs. To seal the remainder LEDs return to package, it's recommended to be with workable desiccants in original package.

9.3 Cleaning

Use alcohol-based cleaning solvents such as isopropyl alcohol to clean the LED if necessary.

9.4 Drive Mode

An LED is a current-operated device. In order to ensure intensity uniformity on multiple LEDs connected in parallel in an application, it is recommended that a current limiting resistor be incorporated in the drive circuit, in series with each LED as shown in Circuit A below

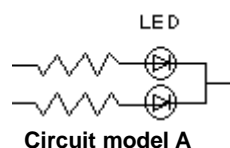

(A) Recommended circuit.

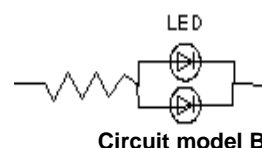

(B) The brightness of each LED might appear different due to the differences in the I-V characteristics of those LEDs.

Specific Lighting LTW-5630SP660

9.5 ESD (Electrostatic Discharge)

Static Electricity or power surge will damage the LED. Suggestions to prevent ESD damage:

- Use of a conductive wrist band or anti-electrostatic glove when handling these LEDs.
- All devices, equipment, and machinery must be properly grounded.
- Work tables, storage racks, etc. should be properly grounded.
- Use ion blower to neutralize the static charge which might have built up on surface of the LED's plastic lens as a result of friction between LEDs during storage and handling.

ESD-damaged LEDs will exhibit abnormal characteristics such as high reverse leakage current, low forward voltage, or “no lightup” at low currents. To verify for ESD damage, check for “light up” and V_F of the suspect LEDs at low currents. The V_F of “good” LEDs should be $>2.0V@0.1mA$ for InGaN product and $>1.4V@0.1mA$ for AlInGaP product.

9.6 Suggested Checking List:

- Training and Certification
 1. Everyone working in a static-safe area is ESD-certified?
 2. Training records kept and re-certification dates monitored?
- Static-Safe Workstation & Work Areas
 1. Static-safe workstation or work-areas have ESD signs?
 2. All surfaces and objects at all static-safe workstation and within 1 ft measure less than 100V?
 3. All ionizer activated, positioned towards the units?
 4. Each work surface mats grounding is good?
- Personnel Grounding
 1. Every person (including visitors) handling ESD sensitive (ESDS) items wear wrist strap, heel strap or conductive shoes with conductive flooring?
 2. If conductive footwear used, conductive flooring also present where operator stand or walk?
 3. Garments, hairs or anything closer than 1 ft to ESD items measure less than 100V*?
 4. Every wrist strap or heel strap/conductive shoes checked daily and result recorded for all DLs?
 5. All wrist strap or heel strap checkers calibration up to date?

Specific Lighting LTW-5630SP660

Note: *50V for Blue LED.

- Device Handling
 1. Every ESDS items identified by EIA-471 labels on item or packaging?
 2. All ESDS items completely inside properly closed static-shielding containers when not at static-safe workstation?
 3. No static charge generators (e.g. plastics) inside shielding containers with ESDS items?
 4. All flexible conductive and dissipative package materials inspected before reuse or recycle?

- Others
 1. Audit result reported to entity ESD control coordinator?
 2. Corrective action from previous audits completed?
 3. Are audit records complete and on file?

9.7 Others:

- Do not put any pressure on the light emitting surface either by finger or any hand tool and do not stack the products. Stress or pressure may cause damage to the wires of the LED array.
- This product is not designed for the use under any of the following conditions, please confirm the performance and reliability are well enough if you use it under any of the following conditions
- Do not use sulfur-containing materials in commercial products including the materials such as seals and adhesives that may contain sulfur.
- Do not put this product in a place with a lot of moisture (over 85% relative humidity), dew condensation, briny air, and corrosive gas (Cl, H₂S, NH₃, SO₂, NO_x, etc.), exposure to a corrosive environment may affect silver plating.
- The appearance and specifications of the product may be modified for improvement without prior notice

**Specific Lighting
LTW-5630SP660**

Revision History:

Revision Date:

Last Version:

Version	Page	Content of Change	Date Record
1.0	All		12/14/2016
1.1	Page 8.	Wave length shift related to current & Wave length shift related to temperature	01/13/2017
1.2	Page 5.9	New mW bin	01/18/2017
1.3	Pag.9	New bin table	01/25/2017