

## APF3236SEKJ3ZGKQBKC

3.2 mm x 3.6 mm Full-Color Surface Mount LED Lamp

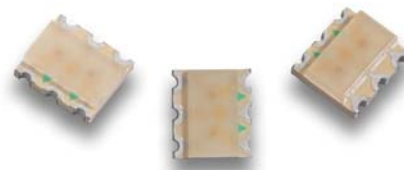

### DESCRIPTIONS

- The Hyper Red device is based on light emitting diode chip made from AlGaInP
- The Green source color devices are made with InGaN on Sapphire Light Emitting Diode
- The Blue source color devices are made with InGaN Light Emitting Diode
- Electrostatic discharge and power surge could damage the LEDs
- It is recommended to use a wrist band or anti-electrostatic glove when handling the LEDs
- All devices, equipments and machineries must be electrically grounded

### FEATURES

- 3.2 mm x 3.6 mm SMD LED, 1.1 mm thickness
- Low power consumption
- One red, one green and one blue chips in one package
- Package: 1000 pcs / reel
- Moisture sensitivity level: 3
- RoHS compliant

### APPLICATIONS

- Backlight
- Status indicator
- Home and smart appliances
- Wearable and portable devices
- Healthcare applications

### ATTENTION

Observe precautions for handling electrostatic discharge sensitive devices



### PACKAGE DIMENSIONS

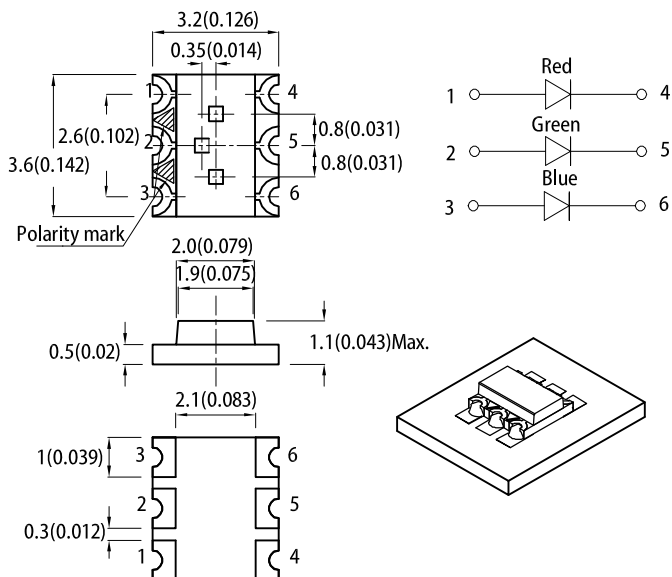

### RECOMMENDED SOLDERING PATTERN

(units : mm; tolerance : ± 0.1)

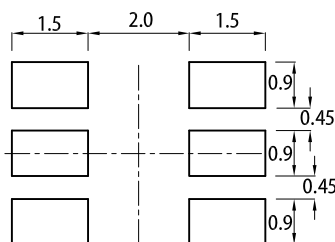

#### Notes:

1. All dimensions are in millimeters (inches).
2. Tolerance is ±0.2(0.008") unless otherwise noted.
3. The specifications, characteristics and technical data described in the datasheet are subject to change without prior notice.
4. The device has a single mounting surface. The device must be mounted according to the specifications.

### SELECTION GUIDE

Part Number	Emitting Color (Material)	Lens Type	Iv (mcd) @ 20mA <sup>[2]</sup>		Viewing Angle <sup>[1]</sup>
			Min.	Typ.	2θ1/2
APF3236SEKJ3ZGKQBKC	■ Hyper Red (AlGaInP)	Water Clear	200	350	150°
	■ Green (InGaN)		200	320	
	■ Blue (InGaN)		40	70	

#### Notes:

1. θ1/2 is the angle from optical centerline where the luminous intensity is 1/2 of the optical peak value.
2. Luminous intensity / luminous flux: +/-15%.
3. Luminous intensity value is traceable to CIE127-2007 standards.

**ELECTRICAL / OPTICAL CHARACTERISTICS at T<sub>A</sub>=25°C**

Parameter	Symbol	Emitting Color	Value		Unit
			Typ.	Max.	
Wavelength at Peak Emission I <sub>F</sub> = 20mA	λ <sub>peak</sub>	Hyper Red Green Blue	640 515 460	-	nm
Dominant Wavelength I <sub>F</sub> = 20mA	λ <sub>dom</sub> <sup>[1]</sup>	Hyper Red Green Blue	625 525 465	-	nm
Spectral Bandwidth at 50% Φ REL MAX I <sub>F</sub> = 20mA	Δλ	Hyper Red Green Blue	20 35 25	-	nm
Capacitance	C	Hyper Red Green Blue	27 45 100	-	pF
Forward Voltage I <sub>F</sub> = 20mA	V <sub>F</sub> <sup>[2]</sup>	Hyper Red Green Blue	2.2 3.3 3.3	2.8 4.1 4.0	V
Reverse Current (V <sub>R</sub> = 5V)	I <sub>R</sub>	Hyper Red Green Blue	-	10 50 50	μA
Temperature Coefficient of λ <sub>peak</sub> I <sub>F</sub> = 20mA, -10°C ≤ T ≤ 85°C	TC <sub>λpeak</sub>	Hyper Red Green Blue	0.13 0.05 0.04	-	nm/°C
Temperature Coefficient of λ <sub>dom</sub> I <sub>F</sub> = 20mA, -10°C ≤ T ≤ 85°C	TC <sub>λdom</sub>	Hyper Red Green Blue	0.06 0.03 0.03	-	nm/°C
Temperature Coefficient of V <sub>F</sub> I <sub>F</sub> = 20mA, -10°C ≤ T ≤ 85°C	TC <sub>V</sub>	Hyper Red Green Blue	-2 -3 -3	-	mV/°C

## Notes:

1. The dominant wavelength (λ<sub>d</sub>) above is the setup value of the sorting machine. (Tolerance λ<sub>d</sub>: ±1nm.)
2. Forward voltage: ±0.1V.
3. Wavelength value is traceable to CIE127-2007 standards.
4. Excess driving current and / or operating temperature higher than recommended conditions may result in severe light degradation or premature failure.

**ABSOLUTE MAXIMUM RATINGS at T<sub>A</sub>=25°C**

Parameter	Symbol	Value			Unit
		Hyper Red	Green	Blue	
Power Dissipation	P <sub>D</sub>	84	102.5	120	mW
Reverse Voltage	V <sub>R</sub>	5	5	5	V
Junction Temperature	T <sub>j</sub>	115	115	115	°C
Operating Temperature	T <sub>op</sub>	-40 to +85			°C
Storage Temperature	T <sub>stg</sub>	-40 to +85			°C
DC Forward Current	I <sub>F</sub>	30	25	30	mA
Peak Forward Current	I <sub>FM</sub> <sup>[1]</sup>	150	150	150	mA
Electrostatic Discharge Threshold (HBM)	-	3000	450	250	V
Thermal Resistance (Junction / Ambient)	R <sub>th JA</sub> <sup>[2]</sup>	420	630	550	°C/W
Thermal Resistance (Junction / Solder point)	R <sub>th JS</sub> <sup>[2]</sup>	310	540	450	°C/W

## Notes:

1. 1/10 Duty Cycle, 0.1ms Pulse Width.
2. R<sub>th JA</sub>, R<sub>th JS</sub> Results from mounting on PC board FR4 (pad size ≥ 16 mm<sup>2</sup> per pad).
3. Relative humidity levels maintained between 40% and 60% in production area are recommended to avoid the build-up of static electricity – Ref JEDEC/JESD625-A and JEDEC/J-STD-033.

## TECHNICAL DATA

### RELATIVE INTENSITY vs. WAVELENGTH

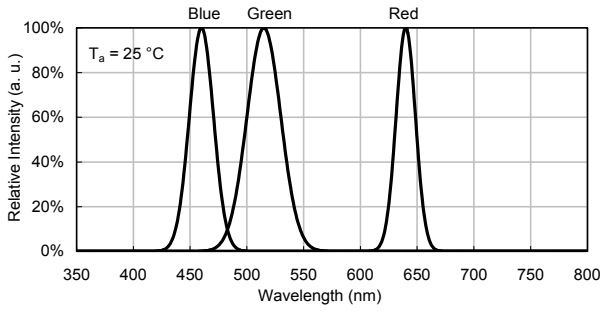

### SPATIAL DISTRIBUTION

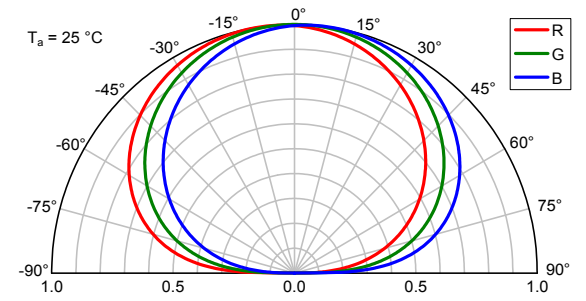

## HYPER RED

Forward Current vs. Forward Voltage

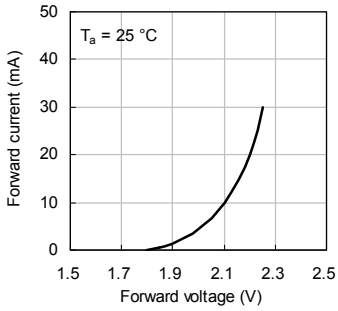

Luminous Intensity vs. Forward Current

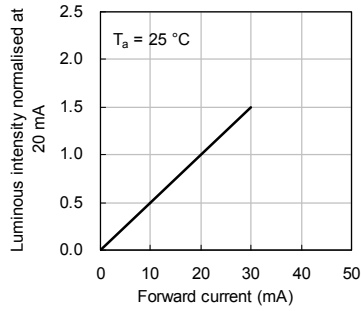

Forward Current Derating Curve

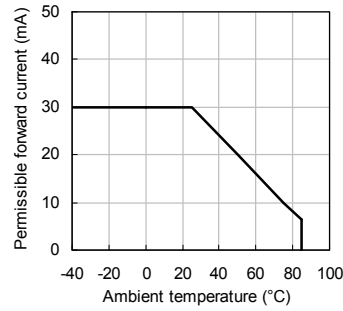

Luminous Intensity vs. Ambient Temperature

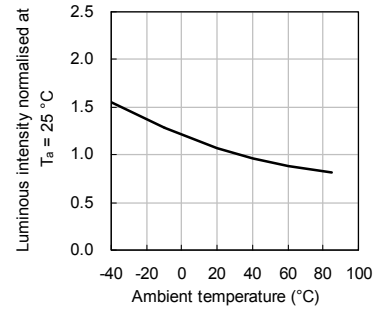

## GREEN

Forward Current vs. Forward Voltage

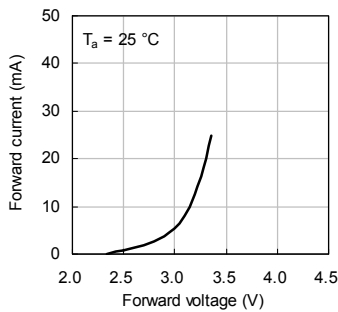

Luminous Intensity vs. Forward Current

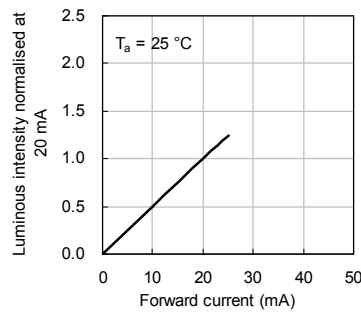

Forward Current Derating Curve

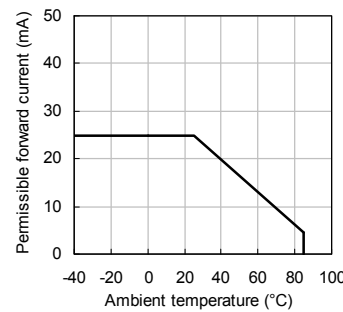

Luminous Intensity vs. Ambient Temperature

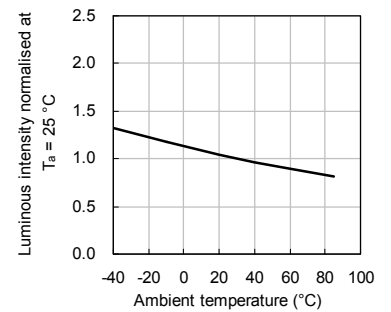

## BLUE

Forward Current vs. Forward Voltage

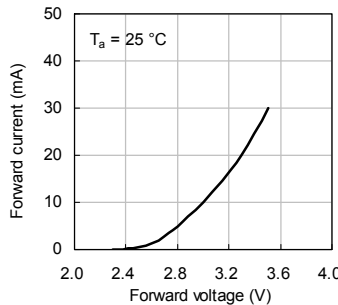

Luminous Intensity vs. Forward Current

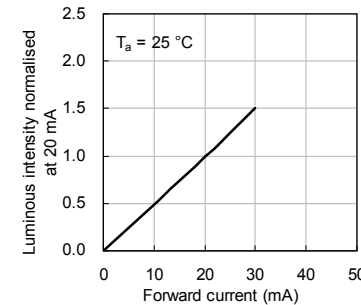

Forward Current Derating Curve

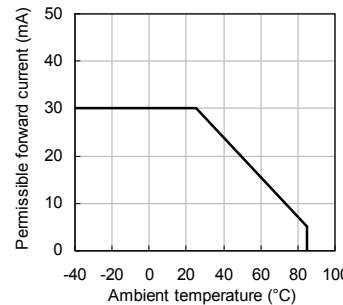

Luminous Intensity vs. Ambient Temperature

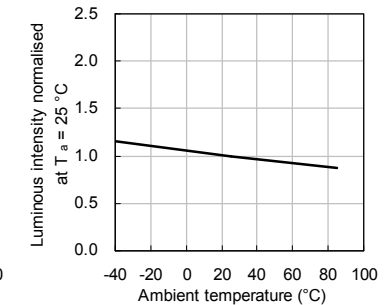

### REFLOW SOLDERING PROFILE for LEAD-FREE SMD PROCESS

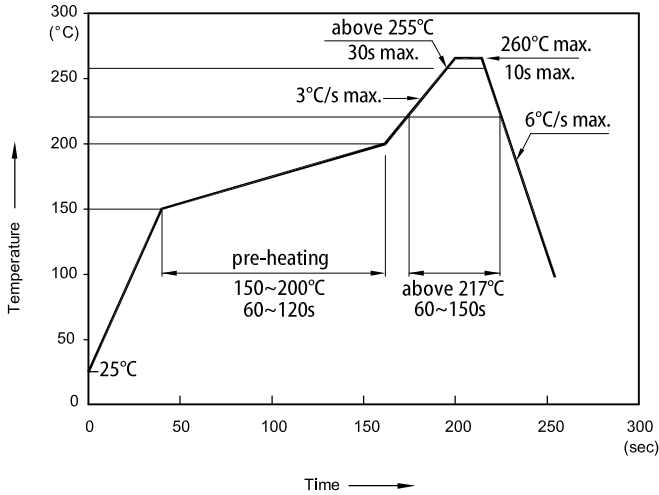

- Notes:
1. Don't cause stress to the LEDs while it is exposed to high temperature.
  2. The maximum number of reflow soldering passes is 2 times.
  3. Reflow soldering is recommended. Other soldering methods are not recommended as they might cause damage to the product.

### TAPE SPECIFICATIONS (units : mm)

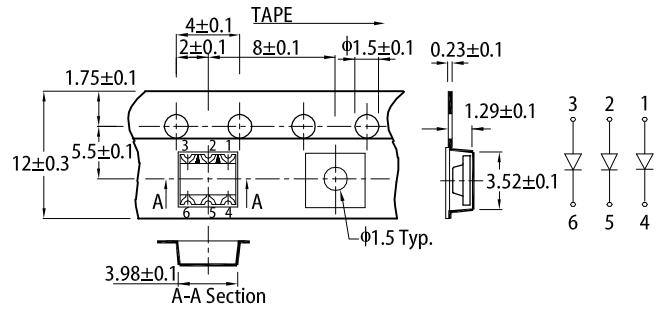

### REEL DIMENSION (units : mm)

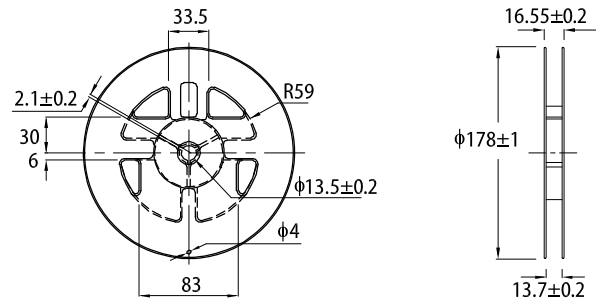

### PACKING & LABEL SPECIFICATIONS

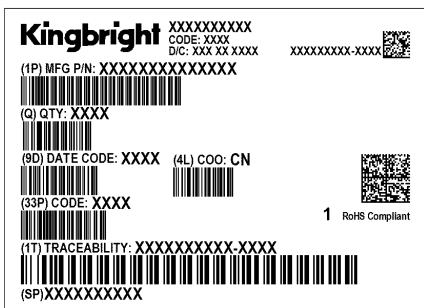
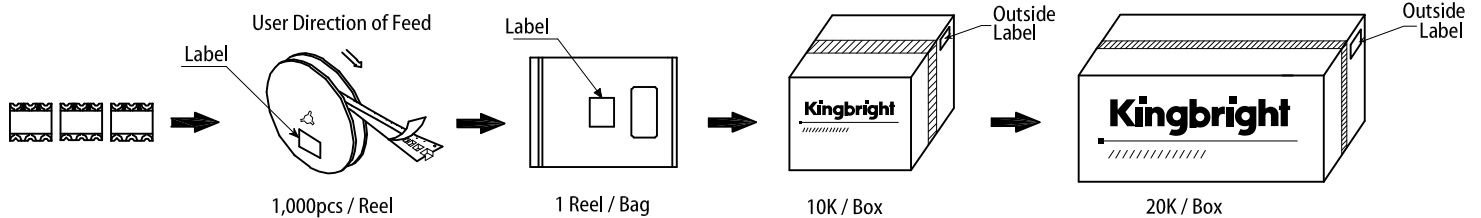

### PRECAUTIONARY NOTES

1. The information included in this document reflects representative usage scenarios and is intended for technical reference only.
2. The part number, type, and specifications mentioned in this document are subject to future change and improvement without notice. Before production usage customer should refer to the latest datasheet for the updated specifications.
3. When using the products referenced in this document, please make sure the product is being operated within the environmental and electrical limits specified in the datasheet. If customer usage exceeds the specified limits, Kingbright will not be responsible for any subsequent issues.
4. The information in this document applies to typical usage in consumer electronics applications. If customer's application has special reliability requirements or have life-threatening liabilities, such as automotive or medical usage, please consult with Kingbright representative for further assistance.
5. The contents and information of this document may not be reproduced or re-transmitted without permission by Kingbright.
6. All design applications should refer to Kingbright application notes available at <https://www.KingbrightUSA.com/ApplicationNotes>