

MIRELLA-50-S

~15° spot beam

SPECIFICATION:

Dimensions	Ø 49.9 mm
Height	24 mm
Fastening	glue
ROHS compliant	yes ⓘ

MATERIALS:

Component	Type	Material	Colour	Finish	Coating
MIRELLA-50-S	Reflector	PC	metal		lacquer







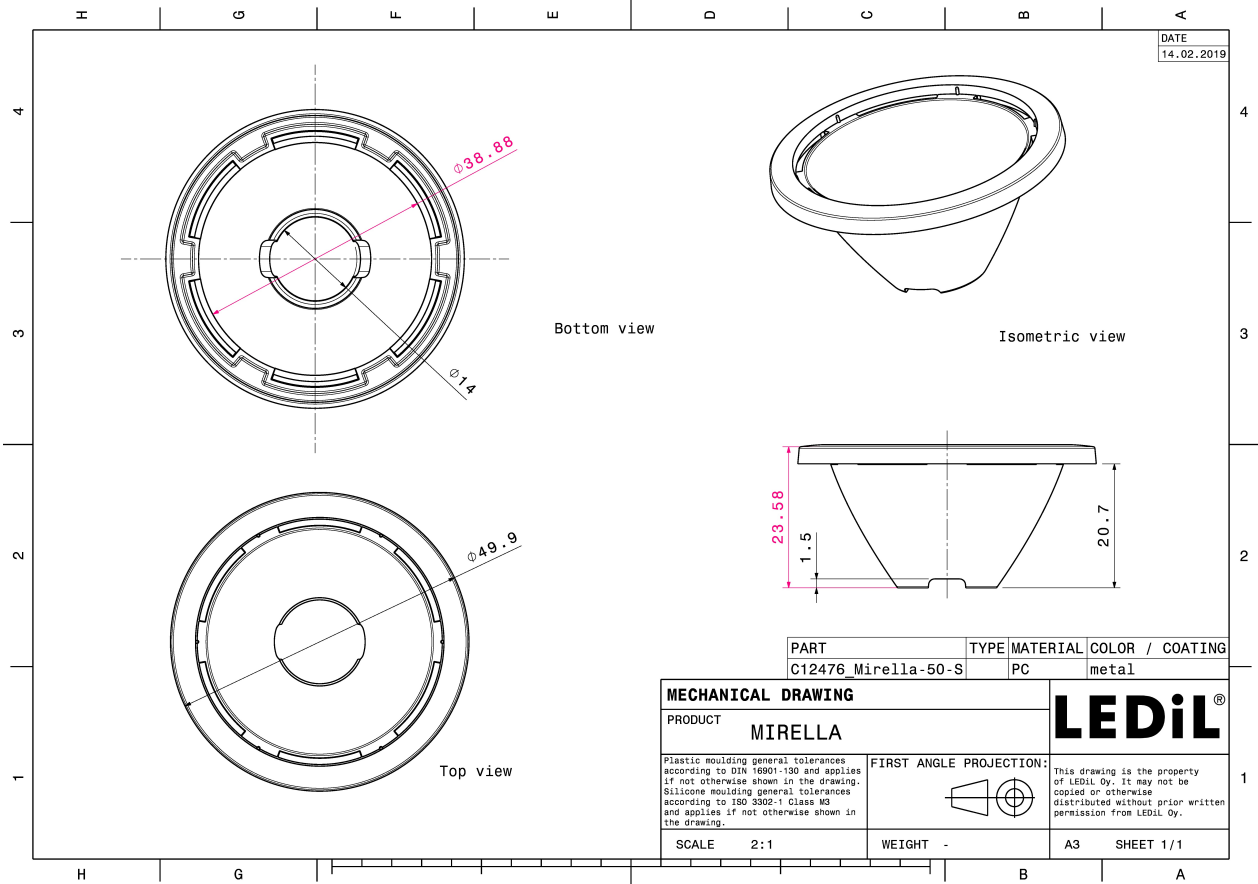

ORDERING INFORMATION:

Component	Qty in box	MOQ	MPQ	Box weight (kg)
C12476_MIRELLA-50-S » Box size: 480 x 280 x 300 mm	336	112	28	3.0

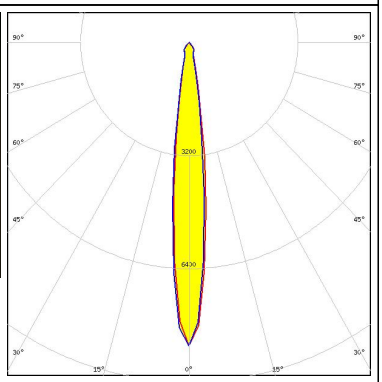

See also our general installation guide: www.ledil.com/installation_guide

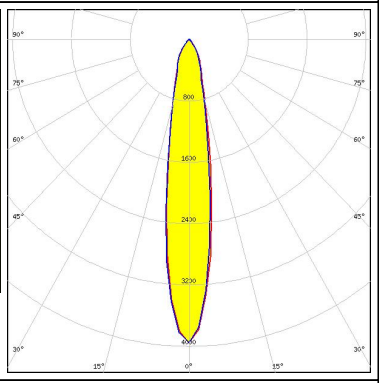
OPTICAL RESULTS (MEASURED):

<p>bridgelux.</p> <p>LED BXRA LS</p> <p>FWHM / FWTM 14.0° / 28.0°</p> <p>Efficiency 84 %</p> <p>Peak intensity 6.7 cd/lm</p> <p>LEDs/each optic 1</p> <p>Light colour White</p> <p>Required components: C13333_MIRELLA-CL</p>		
<p>bridgelux.</p> <p>LED BXRA LS</p> <p>FWHM / FWTM 13.0° / 27.0°</p> <p>Efficiency 89 %</p> <p>Peak intensity 8.6 cd/lm</p> <p>LEDs/each optic 1</p> <p>Light colour White</p> <p>Required components:</p>		
<p>bridgelux.</p> <p>LED BXRA LS</p> <p>FWHM / FWTM 18.0° / 48.0°</p> <p>Efficiency 83 %</p> <p>Peak intensity 4 cd/lm</p> <p>LEDs/each optic 1</p> <p>Light colour White</p> <p>Required components: C12479_MIRELLA-DL</p>		
<h3>CITIZEN</h3> <p>LED CLL01x</p> <p>FWHM / FWTM 20.0° / 56.0°</p> <p>Efficiency %</p> <p>LEDs/each optic 1</p> <p>Light colour White</p> <p>Required components: C12479_MIRELLA-DL</p>		

OPTICAL RESULTS (MEASURED):

CITIZEN

LED CLL01x
 FWHM / FWTM 17.0° / 32.0°
 Efficiency 84 %
 Peak intensity 5.5 cd/lm
 LEDs/each optic 1
 Light colour White
 Required components:
 C13333_MIRELLA-CL



CITIZEN

LED CLL02x/CLU02x (LES10)
 FWHM / FWTM 19.0° / 50.0°
 Efficiency 84 %
 Peak intensity 3.6 cd/lm
 LEDs/each optic 1
 Light colour White
 Required components:
 C13333_MIRELLA-CL



CITIZEN

LED CLL02x/CLU02x (LES10)
 FWHM / FWTM 28.0° / 67.0°
 Efficiency 82 %
 Peak intensity 2.1 cd/lm
 LEDs/each optic 1
 Light colour White
 Required components:
 C12479_MIRELLA-DL

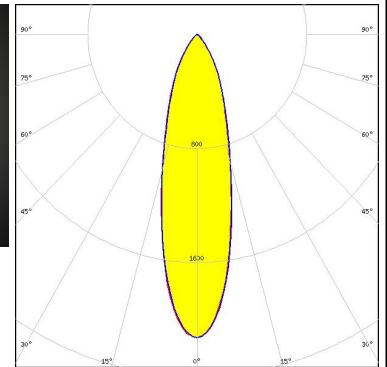
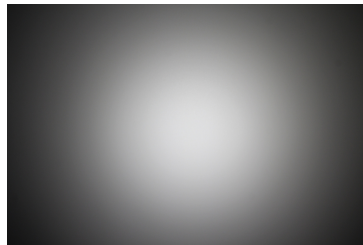

CITIZEN

LED CLL02x/CLU02x (LES10)
 FWHM / FWTM 20.0° / 48.0°
 Efficiency 93 %
 LEDs/each optic 1
 Light colour White
 Required components:



OPTICAL RESULTS (MEASURED):

CITIZEN

LED CLL02x/CLU02x (LES10)
 FWHM / FWTM 32.0° / 70.0°
 Efficiency 81 %
 Peak intensity 1.8 cd/lm
 LEDs/each optic 1
 Light colour White
 Required components:
 C13723_MIRELLA-RZL

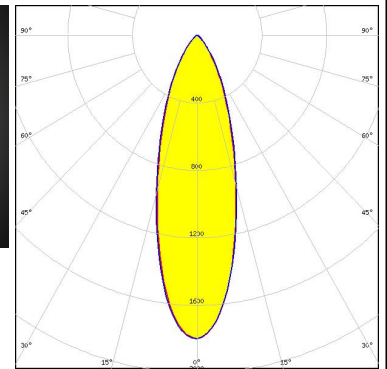
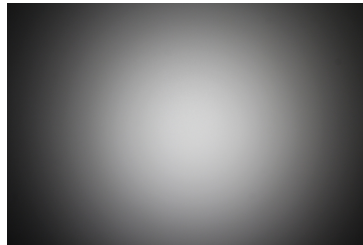

CITIZEN

LED CLU700/701/702/703
 FWHM / FWTM 21.0° / 59.0°
 Efficiency 84 %
 Peak intensity 3.1 cd/lm
 LEDs/each optic 1
 Light colour White
 Required components:
 C12479_MIRELLA-DL

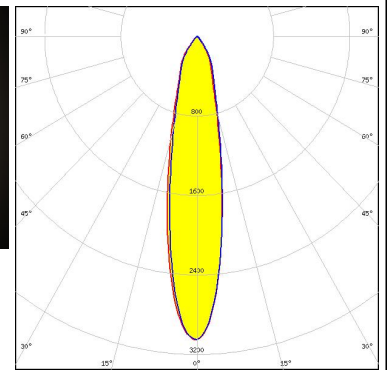
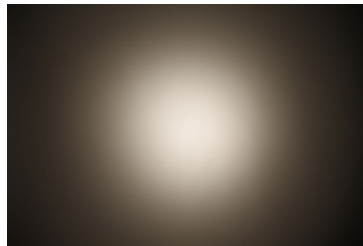

CITIZEN

LED CLU700/701/702/703
 FWHM / FWTM 15.0° / 32.0°
 Efficiency 90 %
 Peak intensity 6.2 cd/lm
 LEDs/each optic 1
 Light colour White
 Required components:

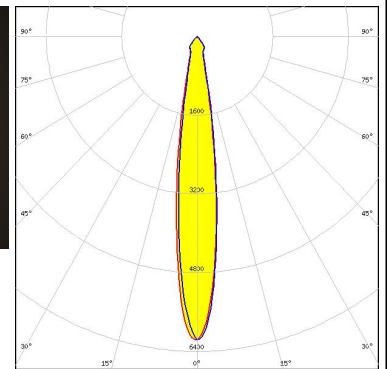

CITIZEN

LED CLU700/701/702/703
 FWHM / FWTM 15.0° / 32.0°
 Efficiency 85 %
 Peak intensity 5.9 cd/lm
 LEDs/each optic 1
 Light colour White
 Required components:
 C13333_MIRELLA-CL

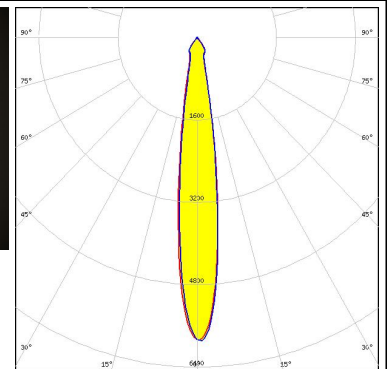

OPTICAL RESULTS (MEASURED):

CITIZEN

LED CLU700/701/702/703
 FWHM / FWTM 26.0° / 64.0°
 Efficiency 83 %
 Peak intensity 2.3 cd/m
 LEDs/each optic 1
 Light colour White
 Required components:
 C13723_MIRELLA-RZL

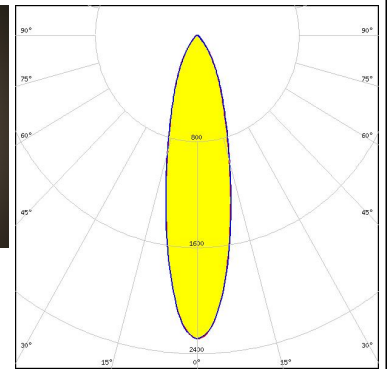
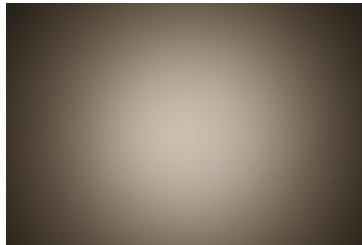

CITIZEN

LED CLU710/711
 FWHM / FWTM 20.0° / 49.0°
 Efficiency 90 %
 Peak intensity 3.7 cd/m
 LEDs/each optic 1
 Light colour White
 Required components:

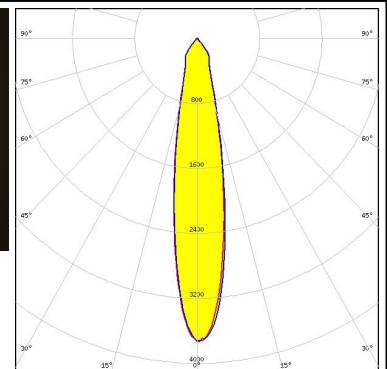
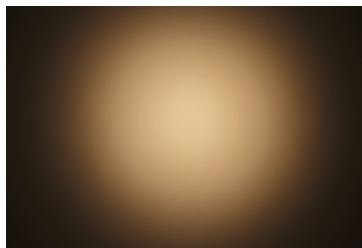

CITIZEN

LED CLU710/711
 FWHM / FWTM 20.0° / 54.0°
 Efficiency 85 %
 Peak intensity 3.4 cd/m
 LEDs/each optic 1
 Light colour White
 Required components:
 C13333_MIRELLA-CL

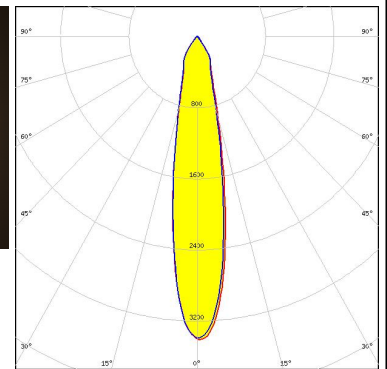
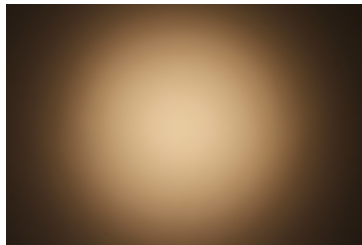

CITIZEN

LED CLU710/711
 FWHM / FWTM 29.0° / 69.0°
 Efficiency 83 %
 Peak intensity 1.9 cd/m
 LEDs/each optic 1
 Light colour White
 Required components:
 C13723_MIRELLA-RZL

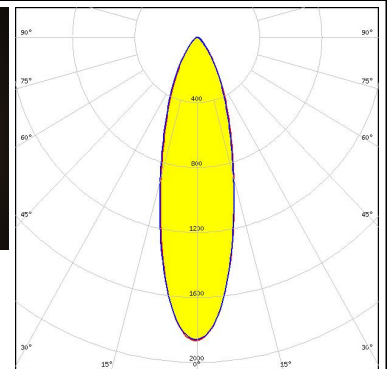
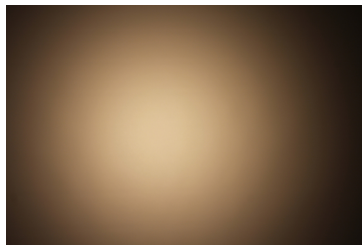

OPTICAL RESULTS (MEASURED):

CITIZEN

LED CLU710/711
 FWHM / FWTM 26.0° / 67.0°
 Efficiency 83 %
 Peak intensity 2.1 cd/m
 LEDs/each optic 1
 Light colour White
 Required components:
 C12479_MIRELLA-DL

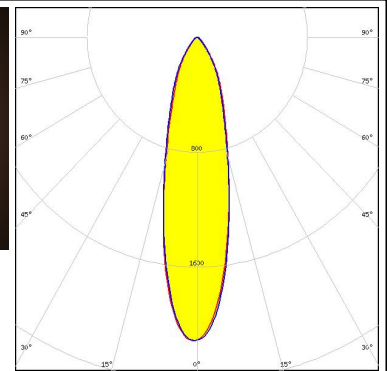
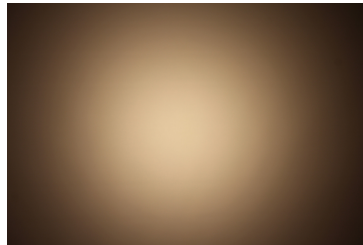

CITIZEN

LED CLU720/721/723
 FWHM / FWTM 25.0° / 66.0°
 Efficiency 85 %
 Peak intensity 2.5 cd/m
 LEDs/each optic 1
 Light colour White
 Required components:
 C13333_MIRELLA-CL

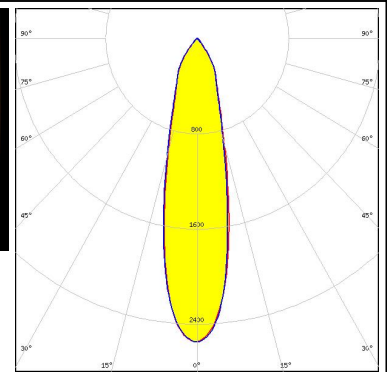
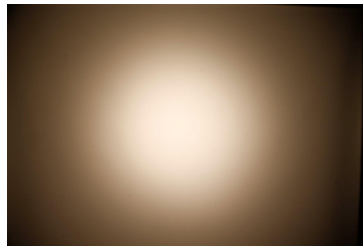

CITIZEN

LED CLU720/721/723
 FWHM / FWTM 32.0° / 73.0°
 Efficiency 83 %
 Peak intensity 1.7 cd/m
 LEDs/each optic 1
 Light colour White
 Required components:
 C13723_MIRELLA-RZL

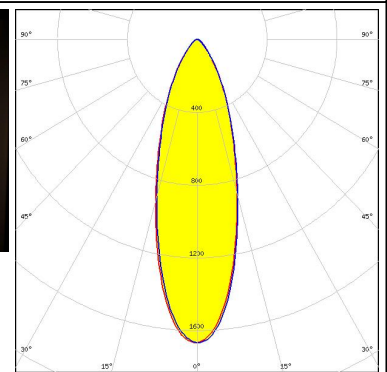
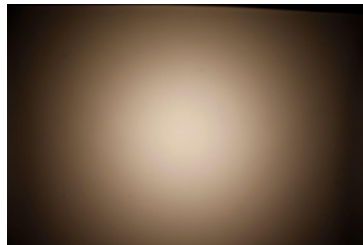

CITIZEN

LED CLU720/721/723
 FWHM / FWTM 24.0° / 68.0°
 Efficiency 90 %
 Peak intensity 2.4 cd/m
 LEDs/each optic 1
 Light colour White
 Required components:

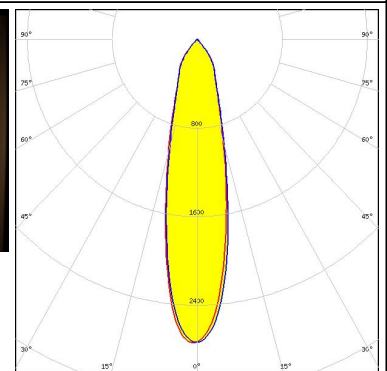
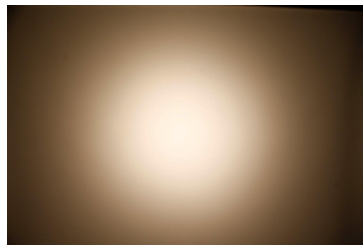

OPTICAL RESULTS (MEASURED):

CITIZEN

LED CLU720/721/723
 FWHM / FWTM 30.0° / 71.0°
 Efficiency 82 %
 Peak intensity 1.8 cd/lm
 LEDs/each optic 1
 Light colour White
 Required components:
 C12479_MIRELLA-DL

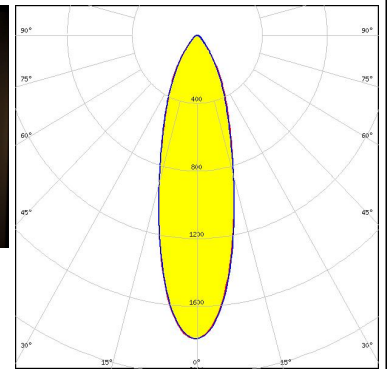
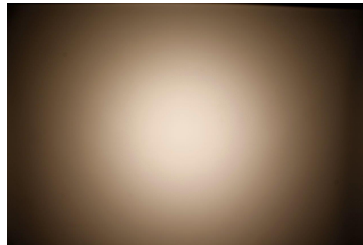

CREE → LED

LED CXA/B 13xx
 FWHM / FWTM 12.0° / 25.0°
 Efficiency 82 %
 Peak intensity 8.5 cd/lm
 LEDs/each optic 1
 Light colour White
 Required components:
 C13333_MIRELLA-CL



CREE → LED

LED CXA/B 13xx
 FWHM / FWTM 15.0° / 36.0°
 Efficiency 81 %
 Peak intensity 5.4 cd/lm
 LEDs/each optic 1
 Light colour White
 Required components:
 C12479_MIRELLA-DL



CREE → LED

LED CXA/B 13xx
 FWHM / FWTM 12.0° / 25.0°
 Efficiency 87 %
 Peak intensity 9.5 cd/lm
 LEDs/each optic 1
 Light colour White
 Required components:



OPTICAL RESULTS (MEASURED):

CREE LED

LED CXA/B 15xx
 FWHM / FWTM 19.0° / 47.0°
 Efficiency 84 %
 Peak intensity 4.3 cd/lm
 LEDs/each optic 1
 Light colour White
 Required components:
 C13333_MIRELLA-CL



CREE LED

LED CXA/B 15xx
 FWHM / FWTM 16.0° / 38.0°
 Efficiency 93 %
 Peak intensity 5.1 cd/lm
 LEDs/each optic 1
 Light colour White
 Required components:

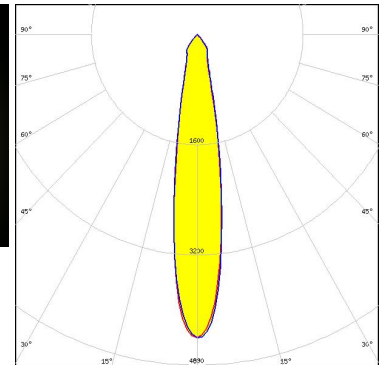

CREE LED

LED CXA/B 15xx
 FWHM / FWTM 20.0° / 60.0°
 Efficiency 90 %
 Peak intensity 3.1 cd/lm
 LEDs/each optic 1
 Light colour White
 Required components:
 C12479_MIRELLA-DL

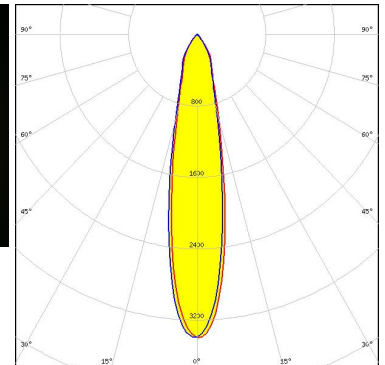

CREE LED

LED CXA/B 1816 & CXA/B 1820 & CXA 1850
 FWHM / FWTM 23.0° / 68.0°
 Efficiency 89 %
 Peak intensity 3.2 cd/lm
 LEDs/each optic 1
 Light colour White
 Required components:

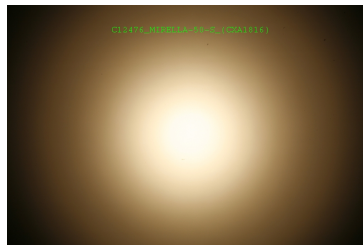

OPTICAL RESULTS (MEASURED):



LED CXA/B 1816 & CXA/B 1820 & CXA 1850
 FWHM / FWTM 25.0° / 68.0°
 Efficiency 83 %
 Peak intensity 2.9 cd/lm
 LEDs/each optic 1
 Light colour White
 Required components:
 C13333_MIRELLA-CL

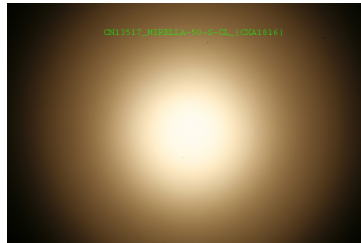

LED CXA/B 1816 & CXA/B 1820 & CXA 1850
 FWHM / FWTM 26.0° / 68.0°
 Efficiency 83 %
 Peak intensity 2.6 cd/lm
 LEDs/each optic 1
 Light colour White
 Required components:
 C12479_MIRELLA-DL

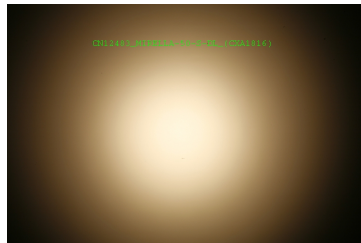

LED MHD-E/G
 FWHM / FWTM 20.0° / 57.0°
 Efficiency 88 %
 Peak intensity 3.3 cd/lm
 LEDs/each optic 1
 Light colour White
 Required components:
 C12479_MIRELLA-DL

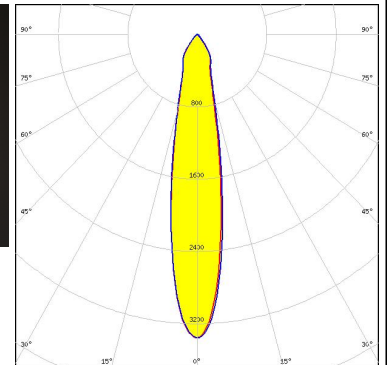
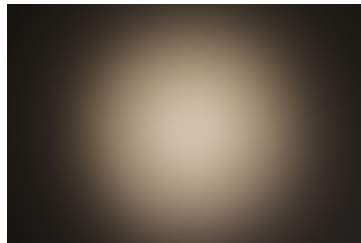

LED MHD-E/G
 FWHM / FWTM 16.0° / 35.0°
 Efficiency 94 %
 Peak intensity 5 cd/lm
 LEDs/each optic 1
 Light colour White
 Required components:

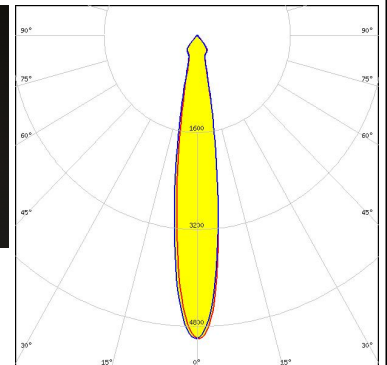
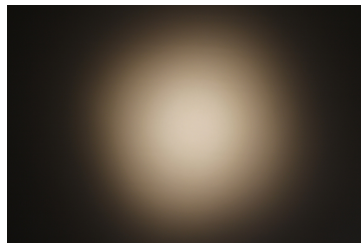

OPTICAL RESULTS (MEASURED):

CREE LED

LED MHD-E/G
 FWHM / FWTM 18.0° / 40.0°
 Efficiency 89 %
 Peak intensity 4.2 cd/lm
 LEDs/each optic 1
 Light colour White
 Required components:
 C13333_MIRELLA-CL

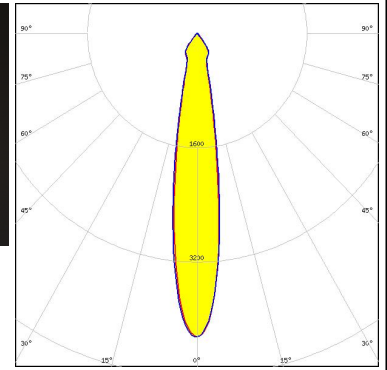
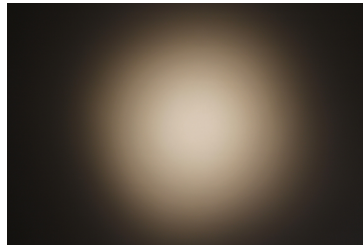

CREE LED

LED MT-G2
 FWHM / FWTM 17.0° / 35.0°
 Efficiency 92 %
 Peak intensity 5.5 cd/lm
 LEDs/each optic 1
 Light colour White
 Required components:

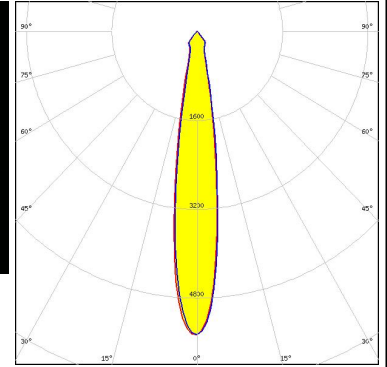

CREE LED

LED MT-G2
 FWHM / FWTM 20.0° / 50.0°
 Efficiency 85 %
 Peak intensity 3.7 cd/lm
 LEDs/each optic 1
 Light colour White
 Required components:
 C12479_MIRELLA-DL

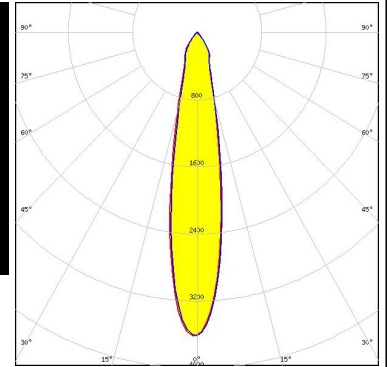







CREE LED

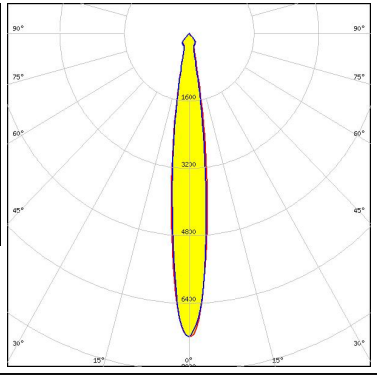

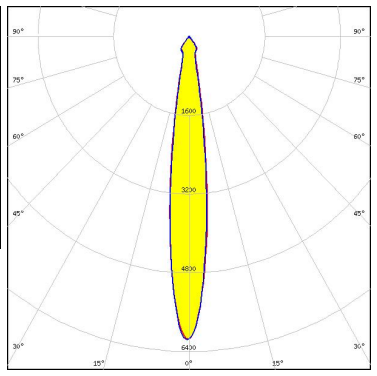

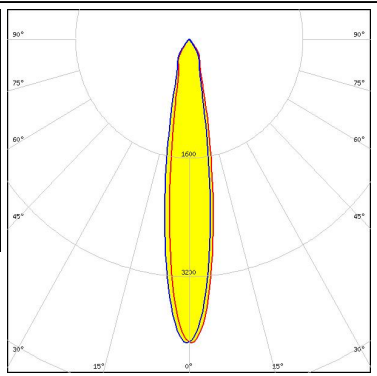

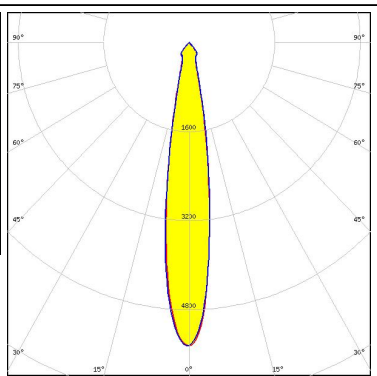
LED MT-G2
 FWHM / FWTM 18.0° / 37.0°
 Efficiency 85 %
 Peak intensity 4.7 cd/lm
 LEDs/each optic 1
 Light colour White
 Required components:
 C13333_MIRELLA-CL



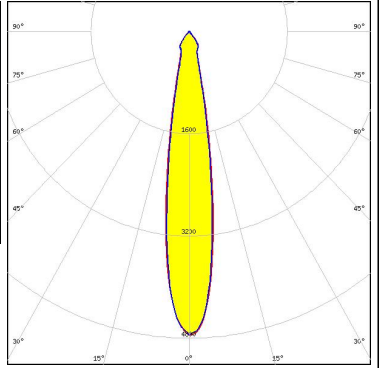

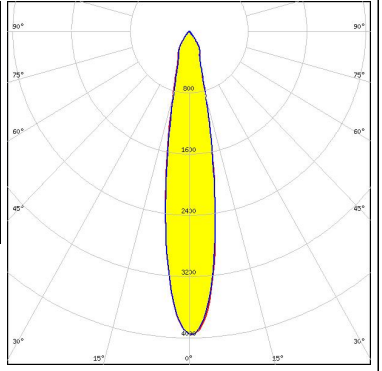
OPTICAL RESULTS (MEASURED):

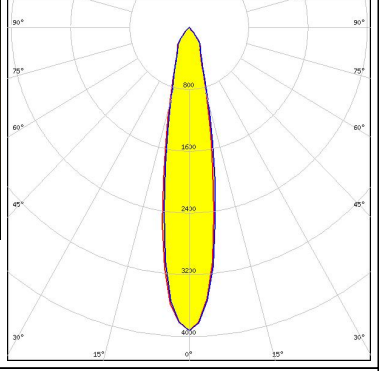
<p>CREE ⇄ LED</p> <p>LED XHP50 FWHM / FWTM 14.0° / 28.0° Efficiency 92 % Peak intensity 7.2 cd/m LEDs/each optic 1 Light colour White Required components:</p>		
<p>CREE ⇄ LED</p> <p>LED XHP50 FWHM / FWTM 14.0° / 30.0° Efficiency 86 % Peak intensity 6.2 cd/m LEDs/each optic 1 Light colour White Required components: C13333_MIRELLA-CL</p>		
<p>CREE ⇄ LED</p> <p>LED XHP50 FWHM / FWTM 17.0° / 44.0° Efficiency 85 % Peak intensity 4.1 cd/m LEDs/each optic 1 Light colour White Required components: C12479_MIRELLA-DL</p>		
<p>CREE ⇄ LED</p> <p>LED XHP70 FWHM / FWTM 17.0° / 34.0° Efficiency 90 % Peak intensity 5.5 cd/m LEDs/each optic 1 Light colour White Required components:</p>		

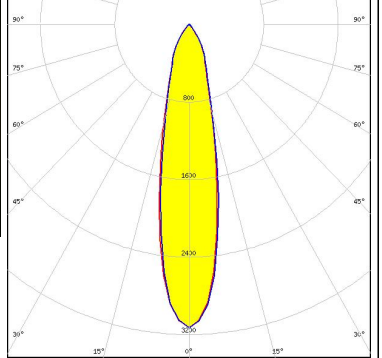

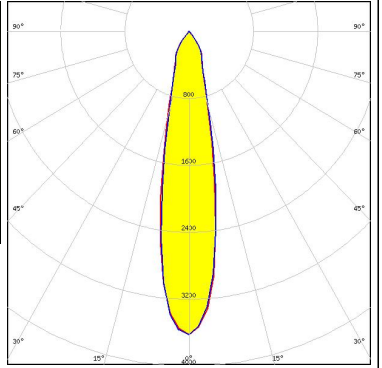
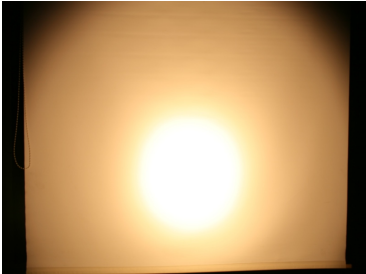

OPTICAL RESULTS (MEASURED):

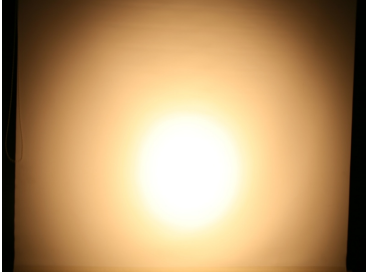
<p>CREE LED</p> <p>LED XHP70 FWHM / FWTM 18.0° / 36.0° Efficiency 86 % Peak intensity 4.8 cd/lm LEDs/each optic 1 Light colour White Required components: C13333_MIRELLA-CL</p>		
<p>CREE LED</p> <p>LED XHP70 FWHM / FWTM 19.0° / 44.0° Efficiency 86 % Peak intensity 4 cd/lm LEDs/each optic 1 Light colour White Required components: C12479_MIRELLA-DL</p>		
<p>LUMILEDS</p> <p>LED LUXEON CoB 1202/1203 FWHM / FWTM 20.0° / 49.0° Efficiency 89 % Peak intensity 3.9 cd/lm LEDs/each optic 1 Light colour White Required components:</p>		
<p>LUMILEDS</p> <p>LED LUXEON CoB 1202/1203 FWHM / FWTM 23.0° / 60.0° Efficiency 85 % Peak intensity 3.1 cd/lm LEDs/each optic 1 Light colour White Required components: C12479_MIRELLA-DL</p>		

OPTICAL RESULTS (MEASURED):

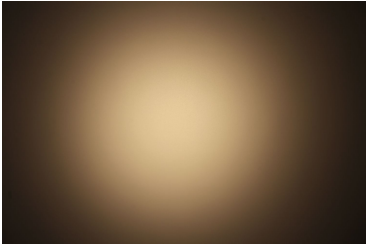
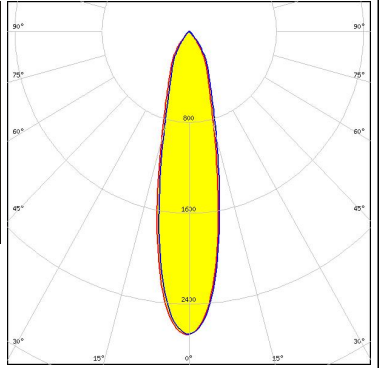
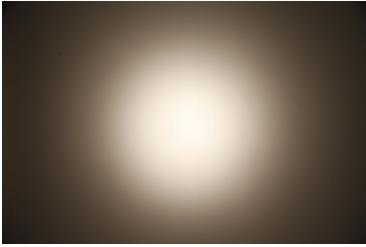
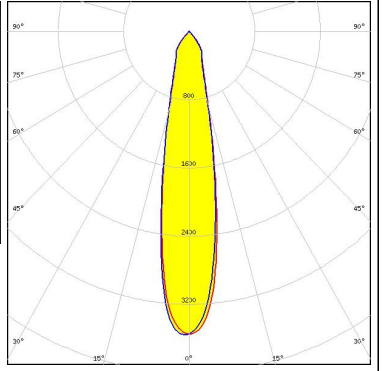
<p>LUMILEDS</p> <p>LED LUXEON CoB 1202/1203</p> <p>FWHM / FWTM 21.0° / 52.0°</p> <p>Efficiency 86 %</p> <p>Peak intensity 3.6 cd/lm</p> <p>LEDs/each optic 1</p> <p>Light colour White</p> <p>Required components: C13333_MIRELLA-CL</p>		
<p>LUMILEDS</p> <p>LED LUXEON S1000</p> <p>FWHM / FWTM 17.0° / 38.0°</p> <p>Efficiency %</p> <p>LEDs/each optic 1</p> <p>Light colour White</p> <p>Required components:</p>		
<p>LUMILEDS</p> <p>LED LUXEON S1000</p> <p>FWHM / FWTM 14.0° / 37.0°</p> <p>Efficiency 84 %</p> <p>Peak intensity 5.5 cd/lm</p> <p>LEDs/each optic 1</p> <p>Light colour White</p> <p>Required components: C13333_MIRELLA-CL</p>		
<p>LUMILEDS</p> <p>LED LUXEON S1000</p> <p>FWHM / FWTM 21.0° / 60.0°</p> <p>Efficiency %</p> <p>LEDs/each optic 1</p> <p>Light colour White</p> <p>Required components: C12479_MIRELLA-DL</p>		

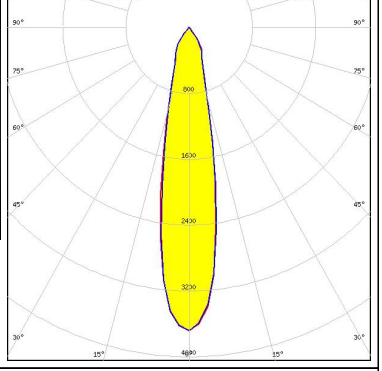
OPTICAL RESULTS (MEASURED):

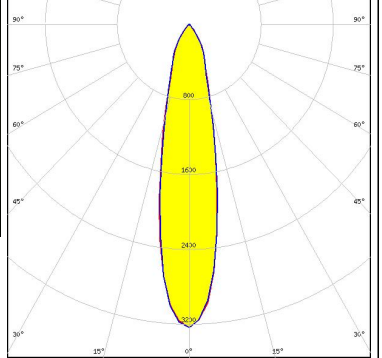
<p>LUMINUS</p> <p>LED CxM-9 (13.5x13.5) FWHM / FWTM 24.0° / 63.0° Efficiency 84 % Peak intensity 2.7 cd/m LEDs/each optic 1 Light colour White Required components: C12479_MIRELLA-DL</p>		
<p>LUMINUS</p> <p>LED CxM-9 (13.5x13.5) FWHM / FWTM 21.0° / 53.0° Efficiency 90 % Peak intensity 3.6 cd/m LEDs/each optic 1 Light colour White Required components:</p>		
<p>NICHIA</p> <p>LED COB L-Type (LES 9) FWHM / FWTM 22.0° / 53.0° Efficiency 87 % Peak intensity 3.7 cd/m LEDs/each optic 1 Light colour White Required components: C13333_MIRELLA-CL</p>		
<p>NICHIA</p> <p>LED COB L-Type (LES 9) FWHM / FWTM 23.0° / 59.0° Efficiency 86 % Peak intensity 3.2 cd/m LEDs/each optic 1 Light colour White Required components: C12479_MIRELLA-DL</p>		

OPTICAL RESULTS (MEASURED):



LED COB L-Type (LES 9)
 FWHM / FWTM 20.0° / 48.0°
 Efficiency 90 %
 Peak intensity 4 cd/lm
 LEDs/each optic 1
 Light colour White
 Required components:

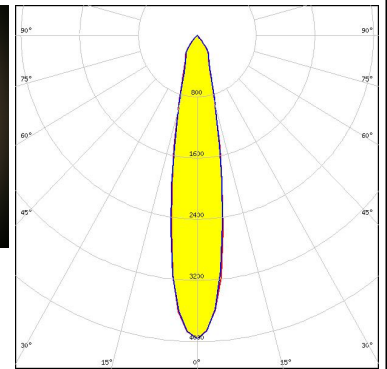

LED NFMW48xA
 FWHM / FWTM 9.5° / 20.0°
 Efficiency 88 %
 Peak intensity 13.6 cd/lm
 LEDs/each optic 1
 Light colour White
 Required components:

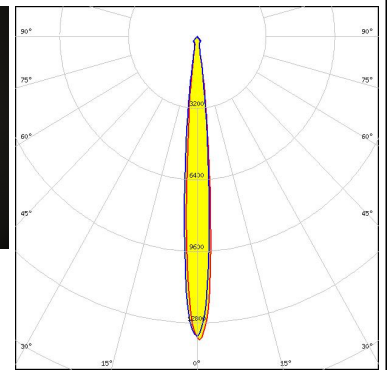



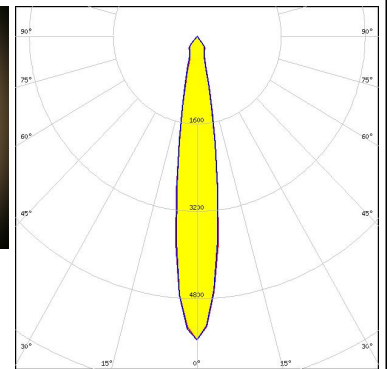

LED NSCxL036A
 FWHM / FWTM 17.0° / 35.0°
 Efficiency 88 %
 Peak intensity 5.6 cd/lm
 LEDs/each optic 1
 Light colour White
 Required components:

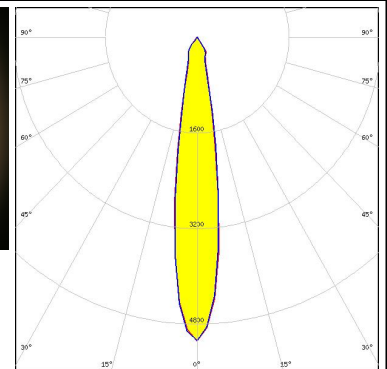



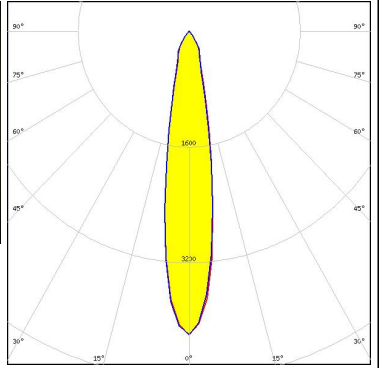

LED NSCxL036A
 FWHM / FWTM 17.0° / 37.0°
 Efficiency 84 %
 Peak intensity 5 cd/lm
 LEDs/each optic 1
 Light colour White
 Required components:
 C13333_MIRELLA-CL



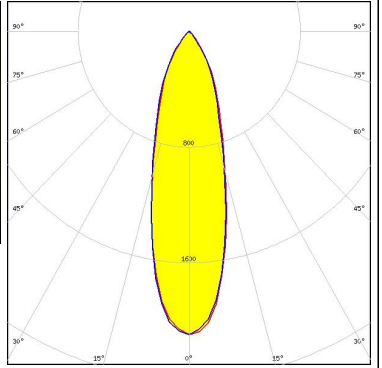

OPTICAL RESULTS (MEASURED):

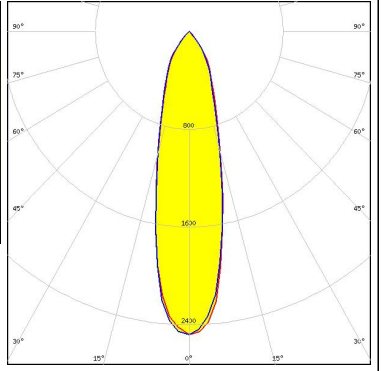
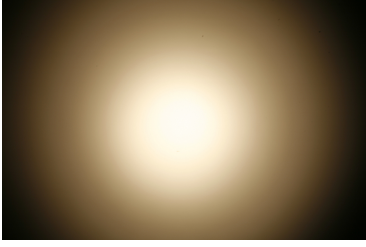
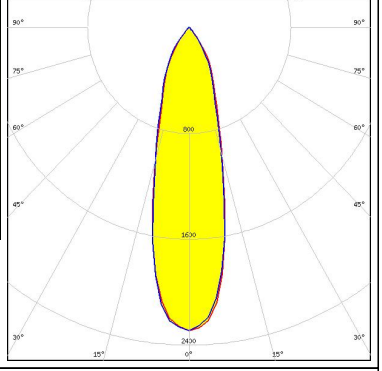
<p>NICHIA</p> <p>LED NSCxL036A FWHM / FWTM 19.0° / 46.0° Efficiency 84 % Peak intensity 4.2 cd/lm LEDs/each optic 1 Light colour White Required components: C12479_MIRELLA-DL</p>		
<p>OSRAM Opto Semiconductors</p> <p>LED Duris S10 FWHM / FWTM 20.0° / 57.0° Efficiency 81 % Peak intensity 3.4 cd/lm LEDs/each optic 1 Light colour White Required components: C12479_MIRELLA-DL</p>		
<p>OSRAM Opto Semiconductors</p> <p>LED Duris S10 FWHM / FWTM 15.0° / 33.0° Efficiency 89 % Peak intensity 6.5 cd/lm LEDs/each optic 1 Light colour White Required components:</p>		
<p>OSRAM Opto Semiconductors</p> <p>LED Duris S10 FWHM / FWTM 15.0° / 33.0° Efficiency 83 % Peak intensity 6.7 cd/lm LEDs/each optic 1 Light colour White Required components: C13333_MIRELLA-CL</p>		

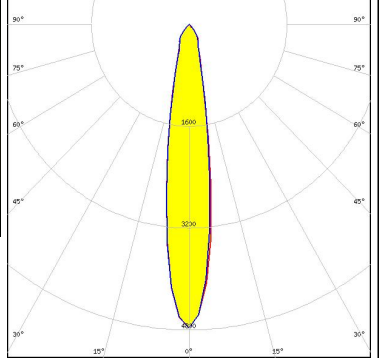
OPTICAL RESULTS (MEASURED):

<p>OSRAM Opto Semiconductors</p> <p>LED Soleriq S13</p> <p>FWHM / FWTM 30.0° / 70.0°</p> <p>Efficiency 83 %</p> <p>Peak intensity 2.1 cd/lm</p> <p>LEDs/each optic 1</p> <p>Light colour White</p> <p>Required components: C12479_MIRELLA-DL</p>		
<p>OSRAM Opto Semiconductors</p> <p>LED Soleriq S13</p> <p>FWHM / FWTM 27.0° / 70.0°</p> <p>Efficiency 87 %</p> <p>Peak intensity 2.5 cd/lm</p> <p>LEDs/each optic 1</p> <p>Light colour White</p> <p>Required components:</p>		
<p>OSRAM Opto Semiconductors</p> <p>LED Soleriq S13</p> <p>FWHM / FWTM 28.0° / 69.0°</p> <p>Efficiency 82 %</p> <p>Peak intensity 2.3 cd/lm</p> <p>LEDs/each optic 1</p> <p>Light colour White</p> <p>Required components: C13333_MIRELLA-CL</p>		
<p>SEOUL SEMICONDUCTOR</p> <p>LED ZC4/6</p> <p>FWHM / FWTM 18.0° / 42.0°</p> <p>Efficiency 88 %</p> <p>Peak intensity 4.8 cd/lm</p> <p>LEDs/each optic 1</p> <p>Light colour White</p> <p>Required components:</p>		

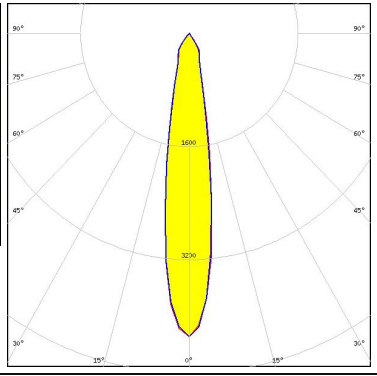
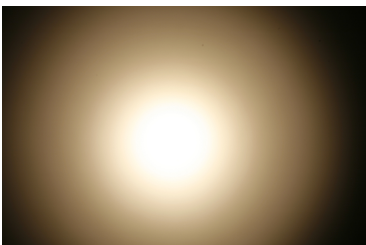
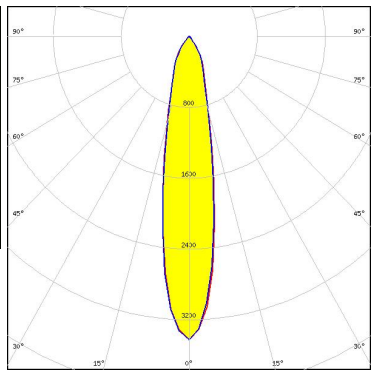
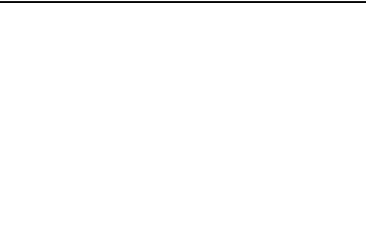
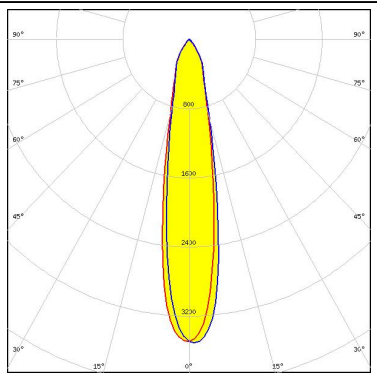
OPTICAL RESULTS (MEASURED):

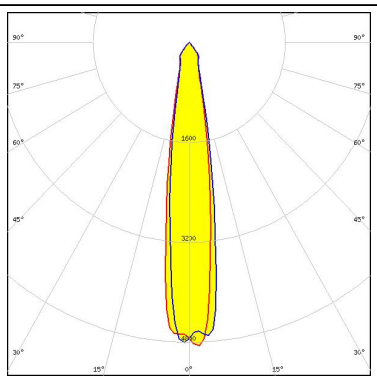
<p>SEOUL SEMICONDUCTOR</p> <p>LED ZC4/6 FWHM / FWTM 19.0° / 44.0° Efficiency 82 % Peak intensity 4.3 cd/m LEDs/each optic 1 Light colour White Required components: C13333_MIRELLA-CL</p>		
<p>SEOUL SEMICONDUCTOR</p> <p>LED ZC4/6 FWHM / FWTM 21.0° / 56.0° Efficiency 83 % Peak intensity 3.4 cd/m LEDs/each optic 1 Light colour White Required components: C12479_MIRELLA-DL</p>		
<p>SHARP</p> <p>LED Mini Zenigata (GW5BM) FWHM / FWTM 20.0° / 54.0° Efficiency 86 % Peak intensity 3.5 cd/m LEDs/each optic 1 Light colour White Required components: C12479_MIRELLA-DL</p>		
<p>SHARP</p> <p>LED Mini Zenigata (GW5BM) FWHM / FWTM 17.0° / 39.0° Efficiency 92 % Peak intensity 4.8 cd/m LEDs/each optic 1 Light colour White Required components:</p>		

OPTICAL RESULTS (MEASURED):

SHARP

LED Mini Zenigata (GW6BM)
 FWHM / FWTM 20.0° / 56.0°
 Efficiency 84 %
 Peak intensity 3.2 cd/lm
 LEDs/each optic 1
 Light colour White
 Required components:
 C12479_MIRELLA-DL

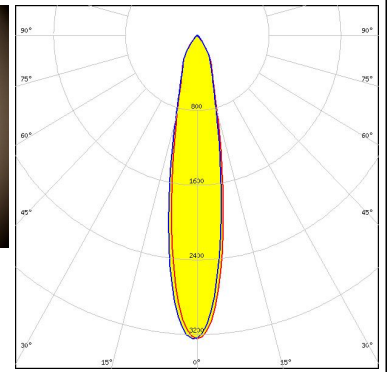
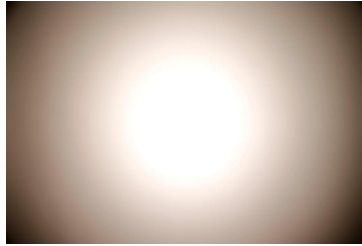

SHARP

LED Mini Zenigata (GW6BM)
 FWHM / FWTM 17.0° / 41.0°
 Efficiency 91 %
 Peak intensity 4.8 cd/lm
 LEDs/each optic 1
 Light colour White
 Required components:

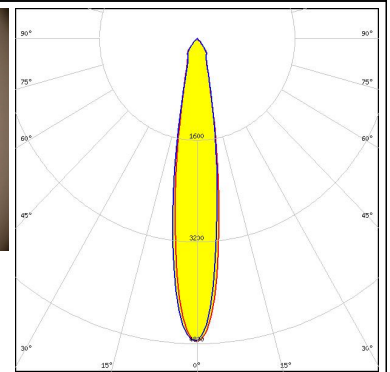
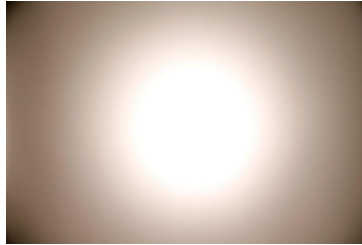

OPTICAL RESULTS (SIMULATED):

<p>LUMILEDS</p> <p>LED LUXEON 7070</p> <p>FWHM / FWTM 14.0° / 27.0°</p> <p>Efficiency 96 %</p> <p>Peak intensity 8.6 cd/lm</p> <p>LEDs/each optic 1</p> <p>Light colour White</p> <p>Required components:</p>	
<p>LUMILEDS</p> <p>LED LUXEON V</p> <p>FWHM / FWTM 7.7° / 17.0°</p> <p>Efficiency 89 %</p> <p>Peak intensity 18.7 cd/lm</p> <p>LEDs/each optic 1</p> <p>Light colour White</p> <p>Required components:</p>	
<p>NICHIA</p> <p>LED NV4x144A</p> <p>FWHM / FWTM 12.0° / 22.0°</p> <p>Efficiency 90 %</p> <p>Peak intensity 11.1 cd/lm</p> <p>LEDs/each optic 1</p> <p>Light colour White</p> <p>Required components:</p>	
<p>OSRAM Opto Semiconductors</p> <p>LED OSCONIQ P 7070</p> <p>FWHM / FWTM 11.0° / 21.0°</p> <p>Efficiency 91 %</p> <p>Peak intensity 12.2 cd/lm</p> <p>LEDs/each optic 1</p> <p>Light colour White</p> <p>Required components:</p>	

OPTICAL RESULTS (SIMULATED):

<p>OSRAM Opto Semiconductors</p> <p>LED: Soleriq S9</p> <p>FWHM / FWTM: 19.0° / 44.0°</p> <p>Efficiency: 91 %</p> <p>Peak intensity: 4.4 cd/lm</p> <p>LEDs/each optic: 1</p> <p>Light colour: White</p> <p>Required components:</p>	
<p>OSRAM Opto Semiconductors</p> <p>LED: Soleriq S9</p> <p>FWHM / FWTM: 21.0° / 55.0°</p> <p>Efficiency: 86 %</p> <p>Peak intensity: 3.4 cd/lm</p> <p>LEDs/each optic: 1</p> <p>Light colour: White</p> <p>Required components: C12479_MIRELLA-DL</p>	
<p>OSRAM Opto Semiconductors</p> <p>LED: Soleriq S9</p> <p>FWHM / FWTM: 20.0° / 48.0°</p> <p>Efficiency: 87 %</p> <p>Peak intensity: 3.9 cd/lm</p> <p>LEDs/each optic: 1</p> <p>Light colour: White</p> <p>Required components: C13333_MIRELLA-CL</p>	

GENERAL INFORMATION:

NOTE: The typical beam angle will be changed by different color, chip size and chip position tolerance. The typical total beam angle is the full angle measured where the luminous intensity is half of the peak value.

Due to use of high power COB's with this product, special attention to proper thermal design is highly recommended. LEDiL has no liability for direct, indirect or consecutive damages arising from the LEDiL products being used outside of the recommended temperature range.

MATERIALS:

As part of our continuous research and improvement processes, and to ensure the best possible quality and availability of our products, LEDiL reserves the right to change material grades without notice.

PRODUCT DATA USER AGREEMENT AND DISCLAIMER:

The measured data in the provided downloadable LEDiL Product Datasheets and Mechanical 2D-Drawings is rounded and provided as reference for planning. LEDiL Oy's optical specifications have been verified by conducting performance testing of the products in accordance with the company's quality system. The reported data are averaged results of multiple measurements with typical variation. LEDiL Oy reserves the right to without prior notification make changes and improvements to its products.

LEDiL Oy assumes neither warranty, nor guarantee nor any other liability of any kind for the contents and correctness of the provided data. The provided data has been generated with highest diligence but the provided data may in reality not represent the complete possible variation range of all intrinsic parameters. Therefore, in certain cases a deviation from the provided data could occur.

LEDiL Oy reserves the right to undertake technical changes of its products without further notification which could lead to changes in the provided data. LEDiL Oy assumes no liability of any kind for the possible deviation from any provided data or any other damage resulting from the usage of the provided data.

The user agrees to this disclaimer and user agreement with the download or usage of the provided files.

LEDiL Oy

Joensuunkatu 13
FI-24240 SALO
Finland

LEDiL Inc.

228 West Page Street
Suite D
Sycamore IL 60178
USA

Ledil Optics Technology (Shenzhen) Co., Ltd.

405 , Block B
Casic Motor Building
Shenzhen 518057
P.R.CHINA

Local sales and technical support

[www.ledil.com/
where_to_buy](http://www.ledil.com/where_to_buy)

Shipping locations

Salo, Finland
Hong Kong, China

Distribution Partners

[www.ledil.com/
where_to_buy](http://www.ledil.com/where_to_buy)