

QPD installation system

Distribute power quickly and easily

Quick installation with fixed or pluggable connections

The QPD installation allows you to connect cables up to 5 x 6.0 mm² quickly and without any hassle or the need for special tools. Thanks to the convenient IDC QUICKON fast connection, you save up to 80% on cabling time – whether you are carrying out a simple cable connection, power distribution or device connection.

You can choose between fixed and pluggable connections with up to four outputs, depending on the application. With QPD, you can pre-assemble male connectors easily and connect them on-site without opening the device.

The installation system consists of plug connectors and cable connectors, H- and T-distributors and panel feed-throughs.



Connectors

for flexible installation and fast device connection



Cable connectors

for easy and safe cable repair



H-distributors

enable a star distributor

Your advantages

- ✓ Time savings of up to 80% for on-site connection
- ✓ Quick and easy assembly without special tools
- ✓ Flexible power distribution, thanks to fixed and pluggable connections
- ✓ Continuously protected electronics because devices can remain closed during connection work on-site
- ✓ Highly reliable with robust housing, IP66/IP68/IP69K degree of protection and IK07 shock resistance



T-distributors

for branching of trunk lines

Panel feed-throughs

eliminate the need to open devices when connecting a cable

Installations in industrial systems and infrastructure facilities

Widely branched industrial systems and infrastructure facilities place stringent requirements on the components in use. QPD offers tough, flexible solutions for continuous power distribution.

Device manufacturers can install QPD panel feed-throughs directly in the device. This enables fast and secure connection of the supply line in the field.



Fast installation

QPD connectors allow equipment such as wind turbines to be started quickly. Use pre-assembled solutions to reduce installation time.



Simple power distribution

In tunnels, the lights and emergency control system must operate reliably. The easy-to-use, robust T- and H-distributors enable you to distribute power over long distances effortlessly.

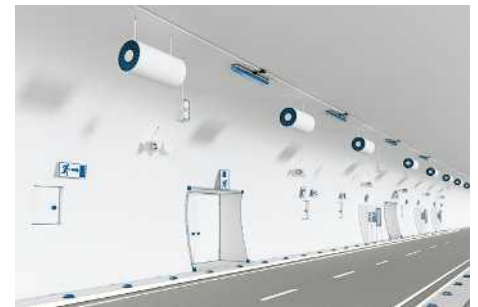

Convenient maintenance

Maintenance work must be carried out quickly and easily in infrastructure facilities. The shock and vibration resistance of the QUICKON connection also eliminates time-consuming service intervals.



High degrees of protection

The IP66/IP68/IP69K degrees of protection and robust design make the QPD ideal for use outside and in wet areas.



Fast light connection

You can connect lights with integrated QPD panel feed-throughs quickly in the field. The housing remains closed, the electronics are fully protected and the device maintains its degree of protection.



Robust motor connection

QPD panel feed-throughs are robust and temperature-resistant. A motor can be connected conveniently on-site without opening the device. This means that the sensitive electronics stay protected from environmental influences.

QUICKON – time savings of up to 80% for on-site connection

The QUICKON fast connection is based on IDC technology and is designed for applications in which cables are connected efficiently on-site. When tightening, the fast connection technology automatically provides contact and strain relief. The fast and easy handling of the QUICKON fast connection reduces connection time significantly. The connection can be disconnected. The components can be used multiple times.

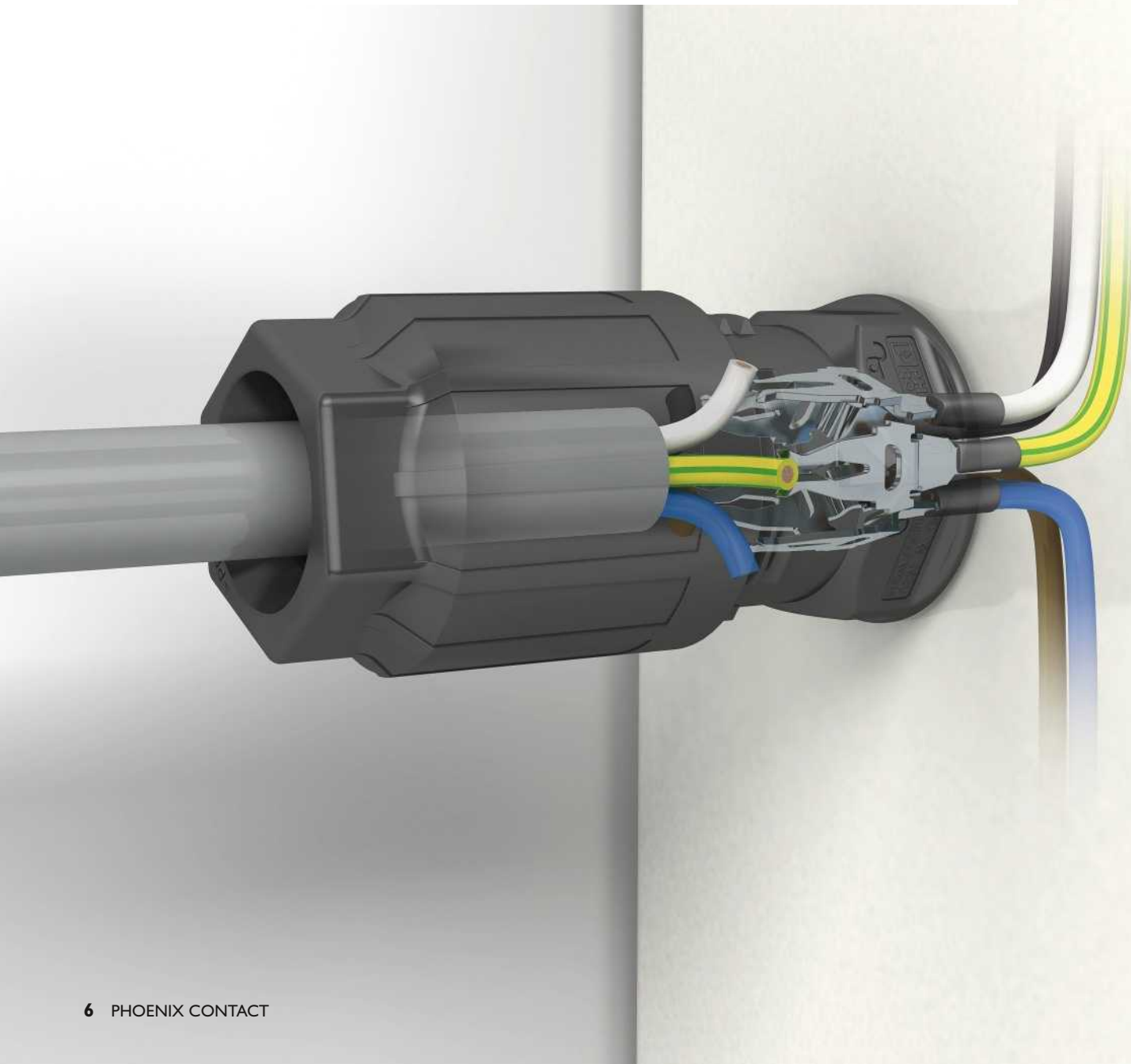

Secure connection in just a few steps

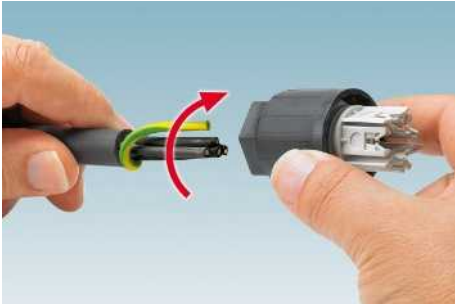

1. Strip the cable and prepare the PE conductor.



2. Guide the wires into the nut and push them into the marked (1, 2, 3, etc.) wire guides until they engage.



3. Cut off the stranded wire ends so they are flush.



4. Place the union nut on the contact carrier and tighten it until it stops or use the specified torque for tightening.



5. You will feel the wires engage when they have reached the optimum screw-on width. The QUICKON nut is now screwed on so tight that it cannot be unscrewed again by hand.



6. The cable can be connected quickly and easily without using any special tools.

Insulation displacement connection (IDC)

For insulation displacement technology, the cable is connected without stripping. The wire guides center the conductors

automatically. When the union nut is tightened, the insulation displacement termination pierces the cable insulation and

establishes a gas-tight electrical contact.

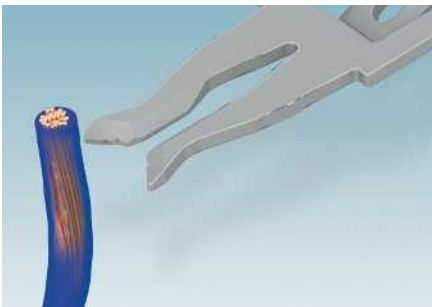

1. Prepare the conductor

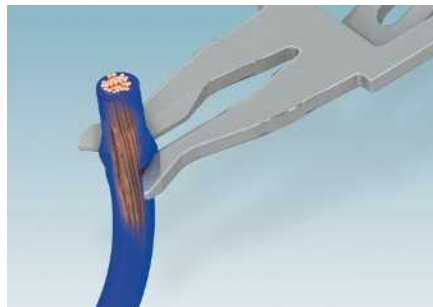

2. The conductor is centered

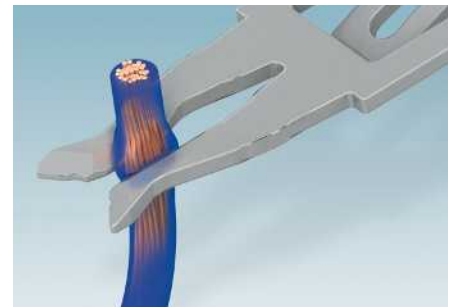

3. Connection to the conductor is gas-tight

QPD product range overview

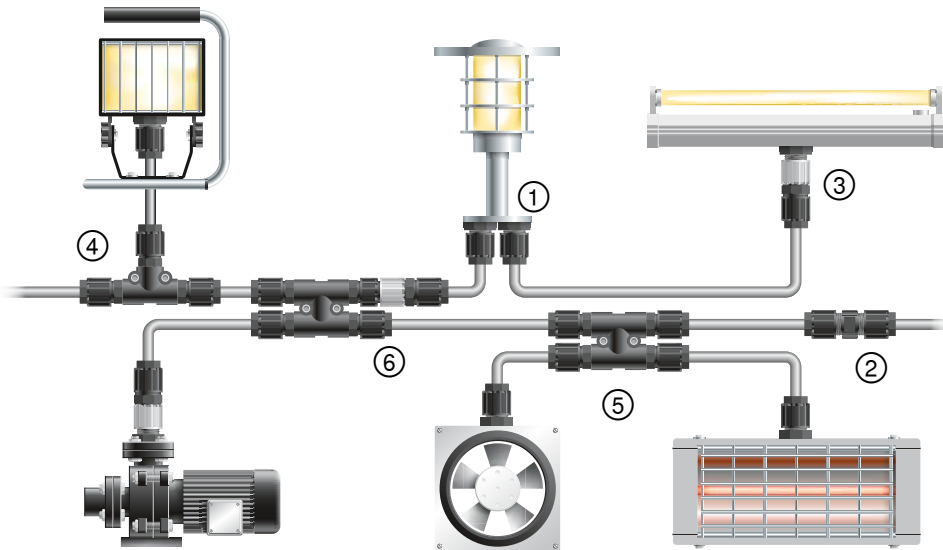

More information on the QPD installation system: simply type the web code into the search field on our website.

i Web code: #0541

Panel feed-throughs

①



M20

M25

Connection data (rigid and flexible)	Number of positions	Cable diameter	M20			M25			
			0.5 m litz wire	1.0 m litz wire	Spade connection	0.5 m litz wire	1.0 m litz wire	Spade connection	Push-in connection
0.5 - 1.5 mm ² : 690 V/ 17.5 A	3	4 - 9 mm	1414684	1414685	1414686				
		8 - 13 mm	1414687	1414688	1414689				
		without nut	1414690	1414691	1414692				
	4	4 - 9 mm	1414675	1414676	1414677				
		8 - 13 mm	1414678	1414679	1414680				
		without nut	1414681	1414682	1414683				
	5	5 - 10 mm				1414730	1414731	1414732	
		9 - 14 mm				1414733	1414734	1414735	
		without nut				1414736	1414737	1414738	
1.0 - 2.5 mm ² : 690 V/ 20 A	4	6 - 10 mm				1423975	1423974	1423976	1423977
		9 - 14 mm				1423980	1423979	1423981	1423982
		without nut				1423983	1423984	1423986	1423985
	5	6 - 11 mm	1403725	1403727	1403729	1582557	1582558	1582559	1411432
		9 - 16 mm	1403731	1403733	1403735	1582561	1582562	1582563	1411433
		without nut	1403737	1403739	1403741	1582565	1582566	1582567	
2.5 - 6.0 mm ² : 690 V/ 40 A	5	9 - 14 mm				1410392	1410393		
		12 - 20 mm				1410394	1410395		
		without nut				1410396	1410397		

① Panel feed-throughs

The panel feed-throughs are cable glands that can be connected from the outside. It is no longer necessary to open devices to connect a cable. This ensures that the specific protection class of the manufacturer is maintained.

② Cable connectors

The cable connector can be used to lengthen or repair cables. When combined with a connector, it can be used as a flexible coupling connection.

③ Connectors

The connector with leading PE contact is ideal for quick device replacement, service situations, and installations with pre-assembled cables. It is coded to prevent incorrect connections.

④ T-distributors

Installation of a branch line for consumers is easy with the compact T-distributor. The cable branches off from the continuous trunk line at a right angle.

⑤ H-distributors

The H-distributor is a compact, robust terminal box that can be connected quickly. The four connections are connected parallel to one another, which allows them to be used as a star distributor.

Cable connectors		Connectors		T-distributors		H-distributors		Nuts	
									
With 1 nut	With 2 nuts			With 2 nuts	With 3 nuts				
1414699	1414700	1414705	1414711	1414712	1414719	1415099			
1414701	1414702	1414706	1414713	1414714	1414720	1415100			
					1414721				
1414694	1414696	1414703	1414707	1414708	1414715	1415097			
1414697	1414698	1414704	1414709	1414710	1414716	1415098			
					1414717				
1414739	1414740	1414749	1414751	1414753	1414755	1415101			
1414741	1414742	1414750	1414752	1414754	1414756	1415104			
					1414757				
1423991	1423989	1423987	1424047	1424045	1423971	1423993			
1423992	1423990	1423988	1424048	1424046	1423972	1423994			
					1423973				
1403834	1403838	1403784	1405403	1405401	1406368	1459663			
1403831	1403836	1403782	1405404	1405402	1406369	1459647			
					1406370				
1410415	1410410	1410386	1411416	1411414	1411422	1410409			
1410416	1410412	1410387	1411417	1411415	1411425	1410406			
					1411426				

Accessories



	Description	Order number	
①	Marker labels for H- and T-distributors for plotting and engraving printable	0806932	
		0819453	
②	IP68 sealing plug Diameter: 7 mm	1400255	
		Diameter: 14 mm	1400284
③	Protective cap for panel feed-throughs, captive, IP68	for 1.5 mm ² , 3/4-pos., black	1414722
		for 1.5 mm ² , 5-pos., black	1414728
		for 2.5 mm ² , 4-pos., black	1414728
		for 2.5 mm ² , 5-pos., gray	1404526
		for 2.5 mm ² , 5-pos., black	1404525
		for 6 mm ² , 5-pos., gray	1411401
		for 6 mm ² , 5-pos., black	1411400
④	Locking nut	M16, green	1640692
		M20, black	1586099
		M25, black	1640715
		Pg21, black	1582655
⑤	Seal for AS-interface cables	for an AS-i cable 2.5 mm ² , 4-pos.	1582462
		for two AS-i cables 2.5 mm ² , 4-pos.	1582464
⑥	Insulating sleeve for spade connector	1670497	

	Description	Order number	
⑦	Protective cap for QUICKON connection, IP50	for 1.5 mm ² , 3/4-pos.	1414723
		for 1.5 mm ² , 5-pos.	1414758
		for 2.5 mm ² , 4-pos.	1414758
		for 2.5 mm ² , 5-pos.	1404528
		for 6 mm ² , 5-pos.	1411403
⑧	Protective cap for connectors, IP50	for 1.5 mm ² , 3/4-pos.	1414724
		for 1.5 mm ² , 5-pos.	1414759
		for 2.5 mm ² , 4-pos.	1414759
		for 2.5 mm ² , 5-pos.	1404529
⑨	Socket wrench for QUICKON nuts	for 6 mm ² , 5-pos.	1411404
		for 1.5 mm ² , 5-pos./2.5 mm ² , 4-pos., wrench size 22	1670206
		for 2.5 mm ² , 5-pos., wrench size 27	1670646
⑩	Coding profile	for 1.5 mm ² , 3/4-pos.	1414729
		for 1.5 mm ² , 5-pos.	1414760
		for 2.5 mm ² , 4-pos.	1425950
		for 2.5 mm ² , 5-pos.	1404530
⑪	Aluminum shielding tape for shielded version	for 6 mm ² , 5-pos.	1411402
			1404531

Technical data

Rated voltage	690 V
Rated current	Up to 40 A
Number of positions	3/4/5
Rated surge voltage	6 kV
Degree of protection	IP66/IP68 (2 m, 24 h)/IP69K
Shock resistance	IK07
Ambient temperature (operating)	-40 °C to +100 °C
IDC-capable wire insulation	PVC/PE/TPE/rubber (more available on request)
Litz wire structure/smallest wire diameter	VDE 0295 Class 1-6/at least 0.15 mm
Frequency of connections QUICKON	10
Connector insertion/withdrawal cycles	> 50
Conductor cross section (solid and stranded)	Up to 6 mm ² /up to 10 (AWG)

Individual plug-and-play solutions

Your special applications also require special solutions. Benefit from our wide selection of cable types and connectors.

We assemble a wide variety of cables with QPD connectors or attach the right ferrules and cable lugs for your device connection to QPD panel feed-throughs. Our service center turns your needs into a custom-made product. To take advantage of this option, please get in touch with your local contact person.

Your advantages

- Maximum flexibility
- Reduced storage costs due to small number of item versions
- Shortened assembly times
- A wide variety of cable quality levels
- Support in planning from our sales experts
- Worldwide support



Our services for you: pre-assembled solutions

In dialog with customers and partners worldwide

Phoenix Contact is a globally present, Germany-based market leader. Our group is synonym for future-oriented components, systems, and solutions in the fields of electrical engineering, electronics, and automation. A global network across more than 100 countries, and 15,000 employees ensure a close proximity to our customers, which we believe is particularly important.

The wide variety of our innovative products makes it easy for our customers to find future-oriented solutions for different applications and industries. We especially focus on the fields of energy, infrastructure, process and factory automation.



You will find our complete product range at:
phoenixcontact.com

PHOENIX CONTACT GmbH & Co. KG
Flachmarktstraße 8
32825 Blomberg, Germany
Phone: +49 52 35 3-00
Fax: +49 52 35 3-4 12 00
E-mail: info@phoenixcontact.com
phoenixcontact.com