

NMB IP69K Fans Protect Your Industrial Welding Equipment



Integrating NMB's robust IP69K fans into your industrial welding equipment can support longer equipment life, reduce power draw and ensure reliable, continuous operation.

Welding is a process that permanently bonds two metal objects together by using high temperature melting which forms a single piece once cooled. There are various welding methods and equipment to achieve this process, however, the most common method is arc welding. Arc welding can be further defined into 4 types: stick, MIG (+flux-cored), TIG and sub arc.

Industrial welding is typically performed in harsh environments with unpredictable conditions. Not only does welding require extreme temperatures in order to melt metal, the process also generates significant fumes, dust and water particles. These factors must be taken into consideration during welding equipment design and component selection.

A reliable power supply unit (PSU) is critical for arc welding. The PSU must deliver very high current, greater than 80 amperes, and typically contains sophisticated circuitry that requires dependable cooling to ensure uninterrupted operation. IP69K-rated cooling fans are the ideal solution for PSU cooling in this harsh environment.





















IP69K Fans for Harsh Environments

To achieve this ingress-protection designation, the fan motor is fully encapsulated by epoxy "potting" which provides complete protection from dust and steam-jet cleaning. The potting process involves molding and coating the circuit board, stator and coils with epoxy resin. This process is performed in-house, and was developed by injection molding technology experts. IP69K - the highest ingress protection rating awarded to a cooling fan manufacturer - ensures protection from the smallest particles as well as high-pressure, high temperature water jets.

IP RATING CHART

1st Digit - SOLIDS		2nd Digit - LIQUID	
	Protection against a solid object greater than 50mm, such as hand. 1		Protection against water drops. 1
	Protection against a solid object greater than 12mm, such as finger. 2		Protection against water drops at a 15 degree angle. 2
	Protection against a solid object greater than 2.5mm, such as wire. 3		Protection against water spray at 60 degree angle. 3
	Protection against a solid object greater than 1.0mm, such as a thin strap. 4		Protection against water splashing from any angle. 4
	Dust protected. Prevent ingress of dust sufficient to cause harm. 5		Protection against water jets from any angle. 5
	Dust tight. No ingress of dust. 6		Protection against powerful water jets and heavy seas. 6
EXAMPLE IP69K 			Protection against the effects of temporary submersion in water. (30 min. at 3 ft.) 7
			Protection against the effects of permanent submersion in water. (Up to 13 ft.) 8
			Protection from close-range, powerful, high temperature water jets. 9K

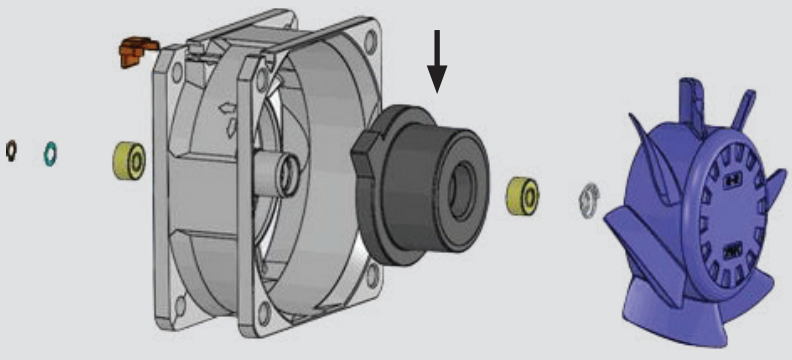

In addition to protection from external contaminants, NMB's IP69K fan are available with pulse-width modulation (PWM) speed control. Our customers can expect longer fan life with PWM speed control - the fan will spin faster only when required, thus reducing bearing load and wear. Power consumption will also be reduced because the fan will demand less power draw according to the duty cycle required.

By incorporating NMB's IP69K into welding PSUs, design engineers can ensure their equipment is resistant to metal dust and other contaminants that can disrupt operation in harsh environments.