

### F16-400

#### Description:

The F16-400 is a single primary and dual secondary, split bobbin design which operates with an input of 115V. The output voltage will be either 16.0V with a center-tap under a 0.4A load with the secondaries wired in series, or 8.0V under a 0.8A load with the secondaries wired in parallel. The split bobbin design eliminates the need for costly electrostatic shielding.

#### Electrical Specifications (@25C)

1. Maximum Power: 6.0VA
2. Primary: 115V, 50/60 Hz
3. Secondary: Series: 16.0V CT@ 0.4A  
Parallel: 8.0V @ 0.8A
4. Voltage Regulation: 25% TYP @ full load to no load
5. Temperature Rise: 25C TYP
6. Hipot tested 100% at 2500 VRMS

#### Construction:

Three flange bobbin construction with primaries and secondaries wound side by side for low capacitive coupling.

#### Agency File:

UL: File E53148, UL 5085-2 (506), Class B General Purpose Transformer,  
cUL: File E53148, UL 5085-2 (506), Class B General Purpose Transformer,  
Canadian Use (CSA 22.2, No.66.2-06)

This model is also available in Class 2, UL 5085-3 (1585) version as [F16-400-C2](#)



#### Dimensions:

Units in inches.

H	W	L	A	B	C	D	E	F
1.312	1.312	1.625	0.250	0.350	1.280	0.041	0.020	0.234

Weight: 0.44 lbs

#### Schematic:

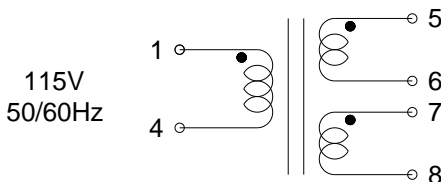

**RoHS Compliance:** As of manufacturing date February 2016, all standard products meet the requirements of 2015/863/EU, known as the RoHS 3 initiative.

As of April 7, 2008, UL standards 506 and 1585 will be migrated to UL 5085-2 and 5085-3, respectively.

\*Upon printing, this document is considered "uncontrolled". Please contact Triad Magnetics website for the most current version. For soldering and washing information please see <http://www.triadmagnetics.com/faq.html>

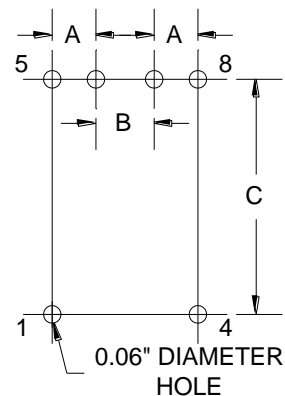
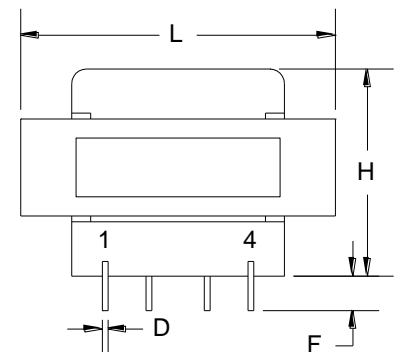
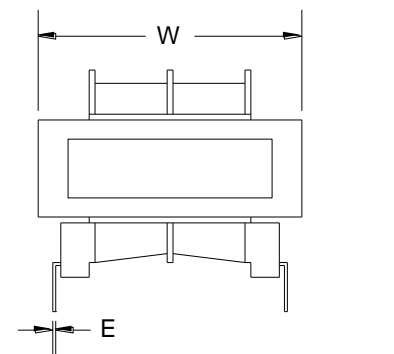

#### Board Layout