

ALS80A303NS200

Aliases (A381TV303M200A)

ALS80, Aluminum Electrolytic, 30,000 uF, 20%, 200 VDC, -40/+105°C

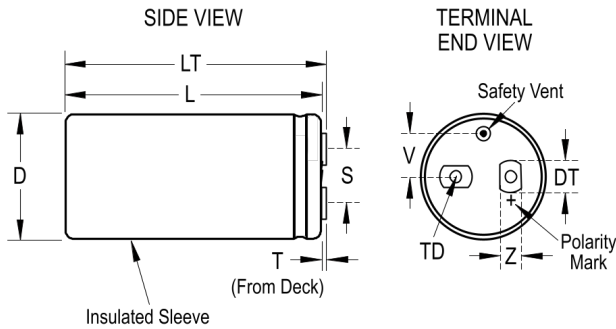

Click [here](#) for the 3D model.

Dimensions

D	77mm +/-1mm
L	194mm +/-2mm
T	5.5mm +/-0.5mm
S	31.8mm +/-0.5mm
DT	13mm +/-0.5mm
LT	198mm +/-1mm
TD	10mm MIN
V	19mm NOM
Z	10mm NOM

Packaging Specifications

Sleeving	Yes
Packaging	Tray

General Information

Series	ALS80
Dielectric	Aluminum Electrolytic
Description	Screw Terminal, Aluminum Electrolytic
RoHS	Yes
AEC-Q200	No
Halogen Free	Yes
Component Weight	1400 g
Notes	Dimensions D And L Include Sleeving. MS (MxH) = M12x16. Mounting Clamp (Sold Separately): V11
Shelf Life	156 Weeks

Specifications

Capacitance	30,000 uF
Capacitance Tolerance	20%
Voltage DC	200 VDC, 230 VDC (Surge)
Temperature Range	-40/+105°C
Rated Temperature	105°C
Life	9000 Hrs (Rated Voltage And Ripple Current At 105C), 15000 Hrs (Rated Voltage At 105C)
Resistance	15 mOhms (100Hz 20C), 12 mOhms (10kHz 20C)
Ripple Current	21.4 Amps (100Hz 105C), 25.7 Amps (10 kHz 105C)
Leakage Current	6000 uA