

High Power LED Series  
3535 Ceramic

LH351H  
630 nm Red

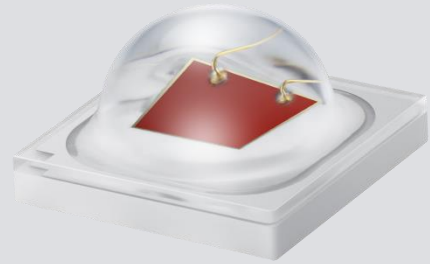

#### Features & Benefits

- Package : 2pad design package with Al<sub>2</sub>O<sub>3</sub>
- Dimension : 3.5 mm X 3.5 mm
- Technology : AlGaInP
- Operates at a maximum current of up to 1.0 A

## Table of Contents

1.	Characteristics	-----	3
2.	Product Code Information	-----	4
3.	Typical Characteristics Graphs	-----	6
4.	Outline Drawing & Dimension	-----	8
5.	Reliability Test Items & Conditions	-----	9
6.	Soldering Conditions	-----	10
7.	Tape & Reel	-----	11
8.	Label Structure	-----	13
9.	Packing Structure	-----	14
10.	Precautions in Handling & Use	-----	16

## 1. Characteristics

### a) Absolute Maximum Rating

Item	Symbol	Rating	Unit	Condition
Ambient / Operating Temperature	$T_a$	-40 ~ +105	°C	Note 1)*
Storage Temperature	$T_{stg}$	-40 ~ +125	°C	-
LED Junction Temperature	$T_j$	125	°C	-
Forward Current ( $T_j$ : 25 °C)	$I_F$	1000	mA	Note 2,3)*-
Reverse Voltage (@ 10 mA)	$V_r$	0.8~1.1	V	-
Minimum Operation Current		5	mA	
Assembly Process Temperature		280 <10	°C s	-
ESD (HBM)	-	±8	kV	-

#### Notes:

- 1) Refer to the derating curve, '3. Typical Characteristics Graph', for proper driving current that maintained below maximum junction temperature.
- 2) Unpredictable performance may be resulted by driving the product at above Max.  $I_F$ . But there will be no damage to the product.
- 3) The measurement condition means that temperature is excluded by applying pulse current for under 30ms.

### b) Electro-optical Characteristics ( $T_j = 25\text{ °C}$ )

Item	Unit	Condition		Value (Typ.)		
		$I_F$ (mA)	$T_j$ (°C)	350mA	550mA	700mA
Radiant Power ( $\Phi_E$ )	mW	350	25	350	545	675
Luminous Flux (lm)	lm	350	25	70 (Min.)		
Forward Voltage ( $V_F$ )	V	350	25	2.15	2.31	2.42
Thermal Resistance (junction to solder point)	°C/W	350	25	4.0	-	-
Beam Angle	°	350	25	120		
Dominant wavelength ( $\lambda_D$ )	nm	350	25	625		

#### Notes:

- 1) Samsung maintains measurement tolerance of: Radiant Power = ±7 %, forward voltage = ±0.1 V, Dominant Wavelength = ±2 nm
- 2) Characteristics @ 25 °C are for reference only

## 2. Product Code Information

1	2	3	4	5	6	7	8	9	10	11	12	13	14	15	16	17	18
S	P	H	R	D	1	L	3	D	H	0	2	C	8	S	4	H	A

Digit	PKG Information	Code	Specification
1 2 3	Samsung Package High Power	<b>SPH</b>	
4 5	Color	<b>RD</b>	Red
6	Product Version	<b>1</b>	
7 8	Product	<b>L3</b>	LH351 Series
9	Lens Type	<b>D</b>	Dome lens
10	Internal Code	<b>H</b>	
11	Not Defined	<b>0</b>	Default
12	Red Version	<b>2</b>	625nm
13 14	Forward Voltage (V)	<b>C8</b>	1.8 ~ 2.6
15 16	Dominant Wavelength (nm)	<b>S4</b>	615 ~ 635
17 18	Luminous Flux (lm)	<b>HA</b>	70~110

**a) Voltage Bins ( $I_F = 350 \text{ mA}$ ,  $T_J = 25 \text{ }^\circ\text{C}$ )**

Product Code	Voltage Rank	Voltage Bin	Voltage Range (V)
SPHRD1L3DH02C8S4HA	C8	C8	1.8 ~ 2.6

**b) Dominant Wavelength Bins ( $I_F = 350 \text{ mA}$ ,  $T_J = 25 \text{ }^\circ\text{C}$ )**

Product Code	Wavelength Rank	Wavelength Bin	Wavelength Range (nm)
SPHRD1L3DH02C8S4HA	S4	S4	615 ~ 635

**c) Radiant Power Bins ( $I_F = 350 \text{ mA}$ ,  $T_J = 25 \text{ }^\circ\text{C}$ )**

Product Code	Power Rank	Power Bin	Flux Range (lm)
SPHRD1L3DH02C8S4HA	HA	HA	70 ~ 110

### 3. Typical Characteristics Graphs

#### a) Spectrum Distribution ( $I_f = 350 \text{ mA}$ , $T_j = 25 \text{ }^\circ\text{C}$ )

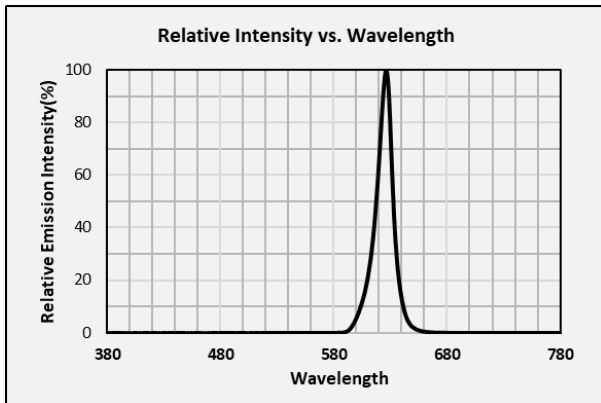

#### b) Forward Current Characteristics ( $T_j = 25 \text{ }^\circ\text{C}$ )

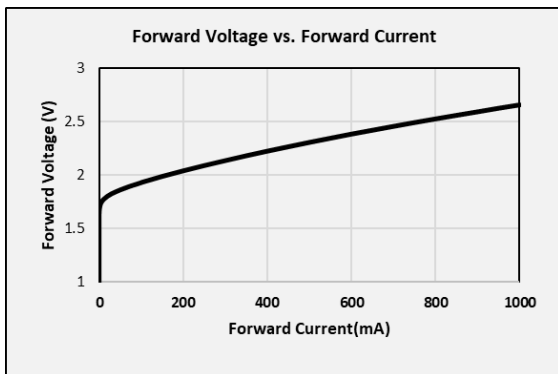
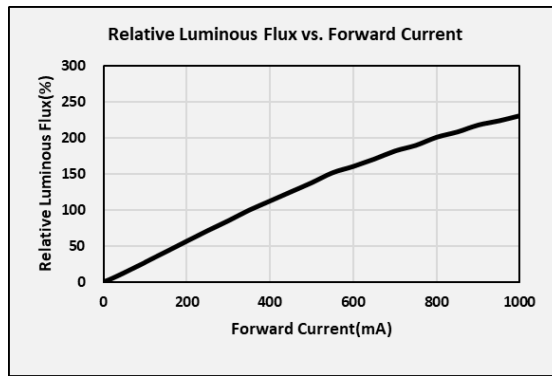
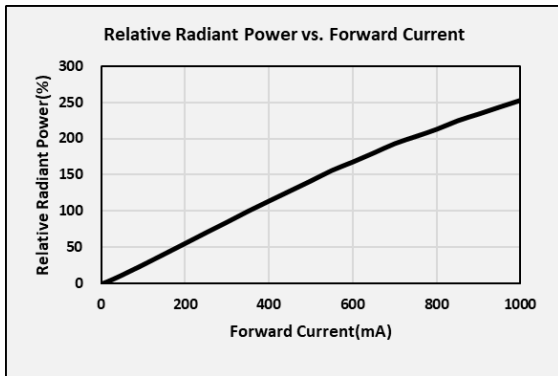

c) Temperature Characteristics ( $I_F = 350\text{mA}$ )

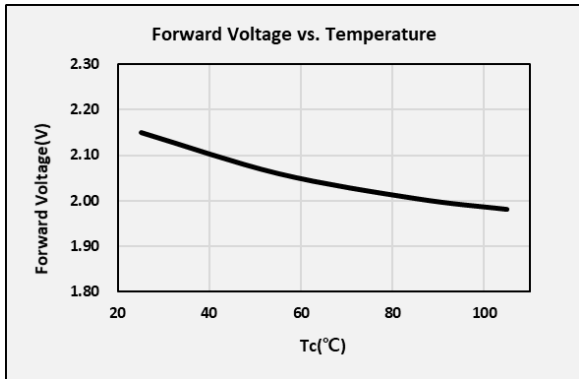
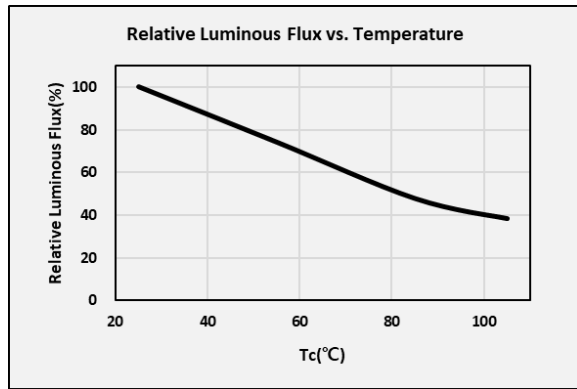
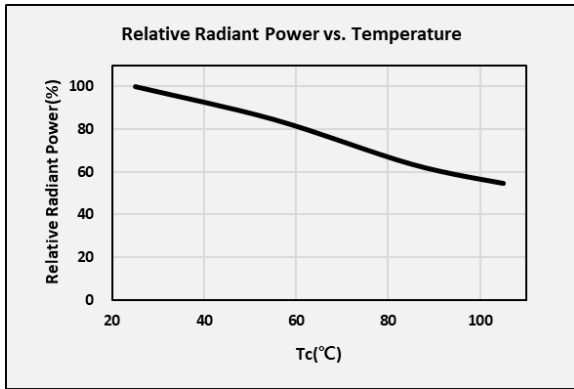

d) Dominant wavelength shift Characteristics ( $I_F = 350\text{ mA}$ ,  $T_j = 25\text{ }^\circ\text{C}$ )

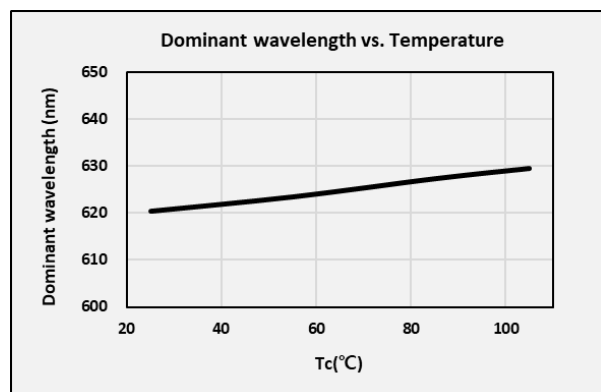
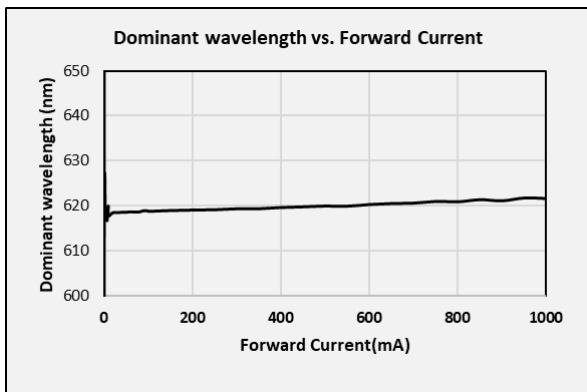

e) Derating Curve and Beam Angle Characteristics ( $I_F = 350 \text{ mA}$ ,  $T_j = 25 \text{ }^\circ\text{C}$ )

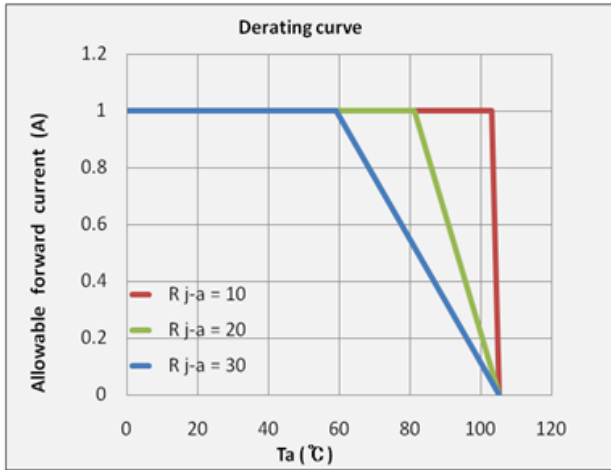

f) Beam Angle Characteristics ( $I_F = 350 \text{ mA}$ ,  $T_j = 25 \text{ }^\circ\text{C}$ )

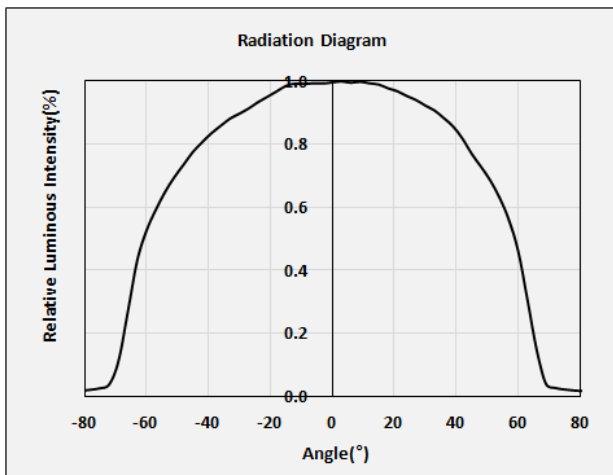



#### 4. Outline Drawing & Dimension

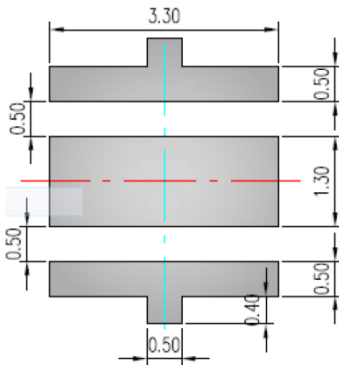
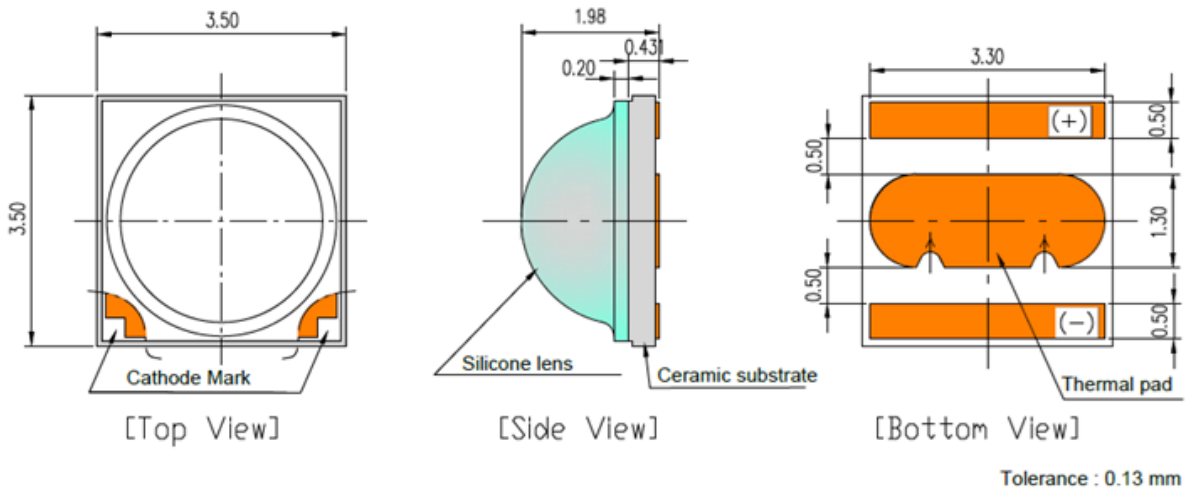

#### Recommended Soldering Pattern

#### Notes:

- 1) This LED has built-in ESD protection device(s) connected in parallel to LED chip(s).
- 2) The thermal pad is electrically isolated from the anode and cathode contact pads.
- 3)  $T_s$  point and measurement method:
  - ① Measure the nearest point to thermal pad as shown above. If necessary, remove PSR of PCB to reach  $T_s$  point.
  - ② All pads must be soldered to the PCB to dissipate heat properly, otherwise the LED can be damaged.

#### Precautions:

- 1) Pressure on the LEDs will influence to the reliability of the LEDs. Precautions should be taken to avoid strong pressure on the LEDs. Do not put stress on the LEDs during heating.
- 2) Re-soldering should not be done after the LEDs have been soldered. If re-soldering is unavoidable, LED's characteristics should be carefully checked before and after such repair.
- 3) Do not stack assembled PCBs together. Since materials of LEDs is soft, abrasion between two PCB assembled with LED might cause catastrophic failure of the LEDs.

## 5. Reliability Test Items & Conditions

### a) Test Items

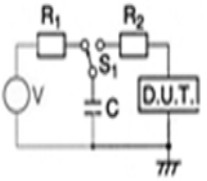
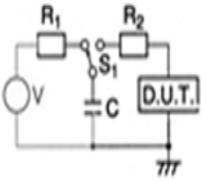
Test Item	Test Condition	Test Hour / Cycle	Sample Size
High Temperature Life Test	85 °C, DC Derating $I_F$	1000 h	22
High Temperature Humidity Life Test	85 °C, 85 % RH, DC Derating $I_F$	1000 h	22
Low Temperature Life Test	-40 °C, DC Derating $I_F$	1000 h	22
Powered Temperature Cycle	-40 °C / 85 °C each 20 min, 100 min transfer power on/off each 5 min, DC Derating $I_F$	100 cycles	11
Temperature Cycling	-45 °C / 15 min ↔ 125 °C / 15 min temperature change within 5 min	500 cycles	100
High Temperature Storage	125 °C	1000 h	11
Low Temperature Storage	-40 °C	1000 h	11
ESD (HBM)	 <p> <math>R_1</math>: 10 M<math>\Omega</math>  <math>R_2</math>: 1.5 k<math>\Omega</math>  <math>C</math>: 100 pF  <math>V</math>: <math>\pm 8</math> kV         </p>	5 times	30
ESD (MM)	 <p> <math>R_1</math>: 10 M<math>\Omega</math>  <math>R_2</math>: 0  <math>C</math>: 200 pF  <math>V</math>: <math>\pm 0.5</math> kV         </p>	5 times	30
Vibration Test	20~2000~20 Hz, 200 m/s <sup>2</sup> , sweep 4 min X, Y, Z 3 direction, each 1 cycle	4 cycles	11
Mechanical Shock Test	1500 g, 0.5 ms 3 shocks each X-Y-Z axis	5 cycles	11

### b) Criteria for Judging the Damage

Item	Symbol	Test Condition ( $T_J = 25$ °C)	Limit	
			Min.	Max.
Forward Voltage	$V_F$	$I_F = 350$ mA	Init. Value * 0.9	Init. Value * 1.1
Luminous Flux	$\Phi_v$	$I_F = 350$ mA	Init. Value * 0.7	Init. Value * 1.1

## 6. Soldering Conditions

### a) Reflow Conditions (Pb free)

Reflow frequency: 2 times max.

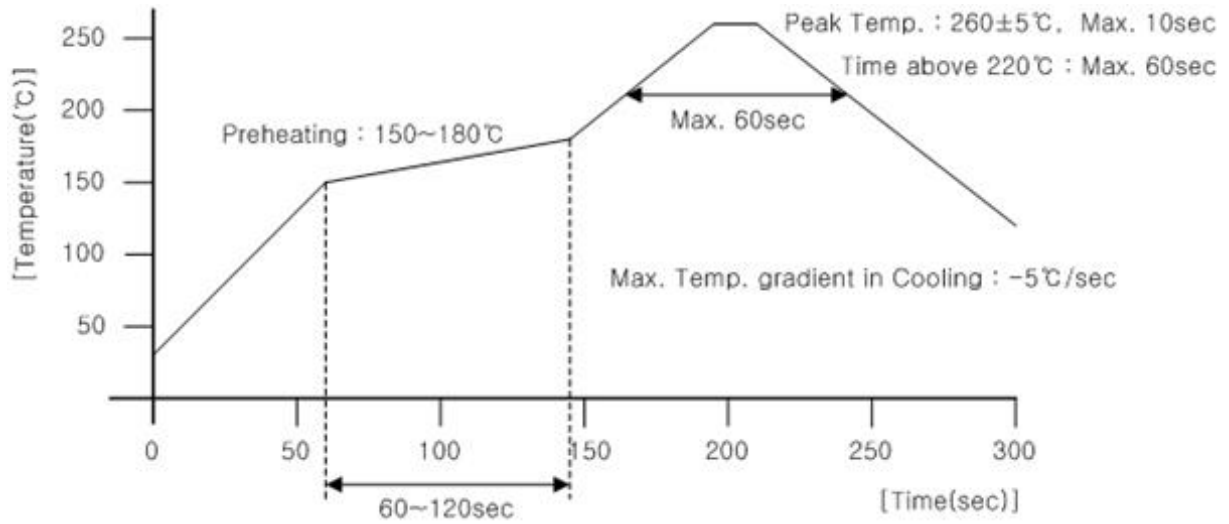

### b) Manual Soldering Conditions

Not more than 5 seconds @ max. 300 °C, under soldering iron.

## 7. Tape & Reel

### a) Taping Dimension

(unit: mm)

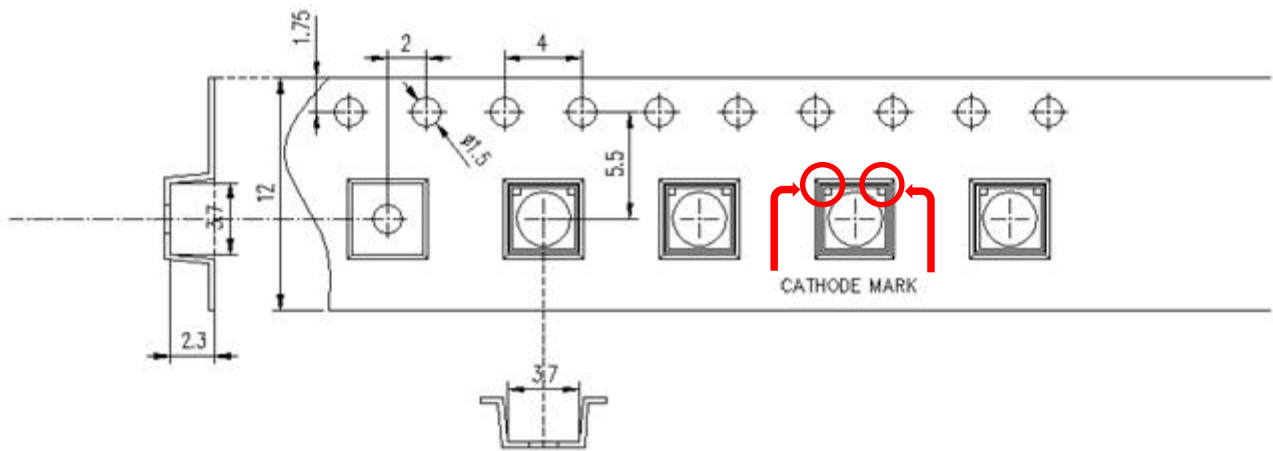

Taping Direction



End

Start

More than 40 mm  
Unloaded tape

Mounted with  
LED package

More than 100~200 mm  
Unloaded tape

Leading part more than  
200~400 mm

## b) Reel Dimension

(unit: mm)

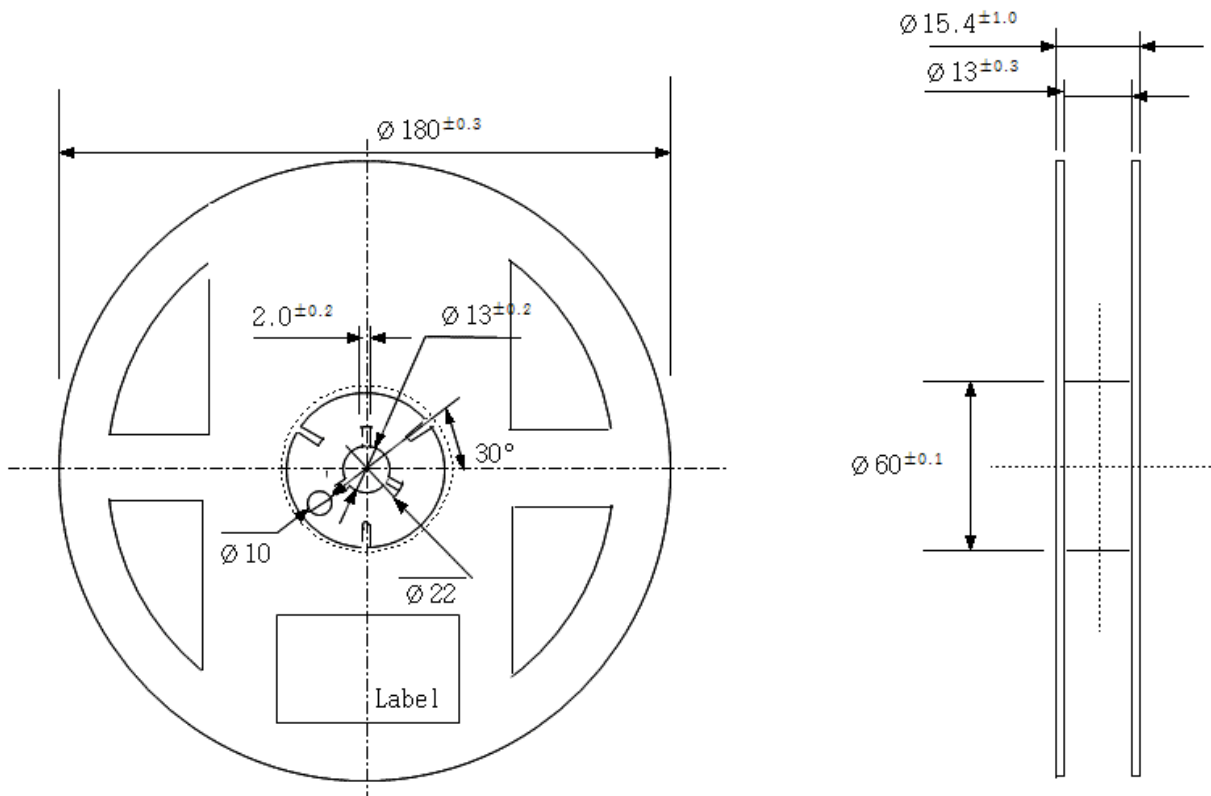

### Notes:

- 1) Quantity: The quantity/reel is 1,000 pcs
- 2) Cumulative tolerance: Cumulative tolerance / 10 pitches is  $\pm 0.2$  mm
- 3) Adhesion strength of cover tape: Adhesion strength is 0.1-0.7 N when the cover tape is turned off from the carrier tape at  $10^{\circ}$  angle to the carrier tape
- 4) Packaging: P/N, Manufacturing data code no. and quantity are indicated on the aluminum packing bag

## 8. Label Structure

### a) Label Structure

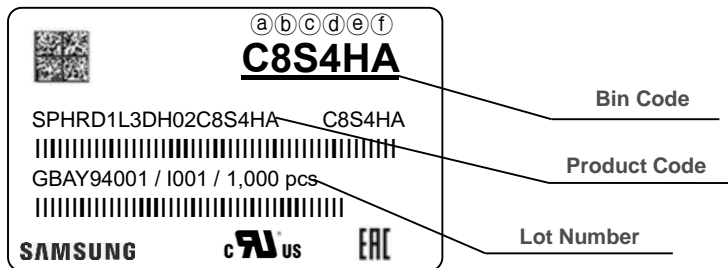

Note: Denoted bin code and product code above is only an example (see description on page 4)

Bin Code:

- ⒶⒷ: Forward Voltage bin (refer to page 5)
- ⒸⒹ: Wavelength bin (refer to page 5)
- ⒺⒻ: Radiant Power bin (refer to page 5)

### b) Lot Number

The lot number is composed of the following characters:

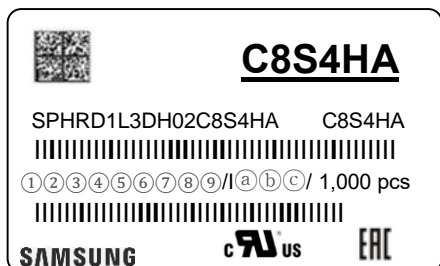

①②③④⑤⑥⑦⑧⑨ / IⒶⒷⒸ / 1,000 pcs

- ①, ② : Production site (GB : Nanchang, China)
- ③ : Product state (A: Normal, B: Bulk, C: First Production, R: Reproduction, S: Sample)
- ④ : Year (C: 2018, D: 2019, E: 2020, ...)
- ⑤ : Month (1~9, A, B, C)
- ⑥ : Day (1~9, A, B~V)
- ⑦⑧⑨ : Product serial number (001 ~ 999)
- ⒶⒷⒸ : Reel number (001 ~ 999)

# 9. Packing Structure

## a) Packing Process

Reel

**C8S4HA**  
 SPHRD1L3DH02C8S4HA C8S4HA  
 GBA94001 / I001 / 1,000 pcs  
**SAMSUNG** **cFL us** **ERC**

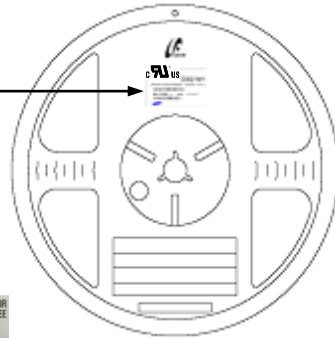

Aluminum Vinyl Packing Bag

**C8S4HA**  
 SPHRD1L3DH02C8S4HA C8S4HA  
 GBA94001 / I001 / 1,000 pcs  
**SAMSUNG** **cFL us** **ERC**



Outer Box

Material: Paper SW(B)

Type	Size (mm)			Note
	(a)	(b)	(c)	
7 inch (L)	245 ± 5	220 ± 5	182 ± 5	Up to 8 reels
7 inch (S)	245 ± 5	220 ± 5	86 ± 5	Up to 4 reels

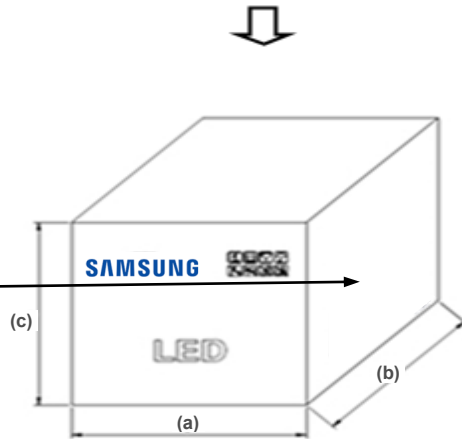

**C8S4HA**  
 SPHRD1L3DH02C8S4HA C8S4HA  
 GBA94001 / I001 / 8,000 pcs  
**SAMSUNG** **cFL us** **ERC**

(1P) Supplier Part Number : SPHRD1L3DH02C8S4HA  
 (33P) Bin Code / C8S4HA  
 (1T) Lot Number / GBA94001  
 (Q) Quantity : 8,000  
 (100) Data Code : 1735  
 (4L) Country of Origin : KR

b) Aluminum Vinyl Packing Bag



**CAUTION**

This bag contains  
**MOISTURE SENSITIVE DEVICES**

**LEVEL**  
**2a**

1. Shelf life in sealed bag: 12 months at <math>< 40^{\circ}\text{C}</math> and <math>< 90\%</math> relative humidity (RH)
2. Peak package body temperature: 240 °C
3. After this bag is opened, devices that will be subjected to reflow solder or other high temperature processes must be:
  - a. Mounted within 672 hours at factory conditions of equal to or less than 30°C /60% RH, or
  - b. Stored at <math>< 10\%</math> RH
4. Devices require bake, before mounting, if:
  - a. Humidity Indicator Card is > 65% when read at 23±5°C, or
  - b. 2a is not met.
5. If baking is required, devices must be baked for 1 hours at 60±5°C

Note: If device containers cannot be subjected to high temperature or shorter bake times are desired, reference IPC/JEDEC J-STD-033 for bake procedure.

Bag seal due date: \_\_\_\_\_  
(if blank, see code label)

Note: Level and body temperature by IPC/JEDEC J-STD-020



**C8S4HA**

SPHRD1L3DH02C8S4HA C8S4HA  
 GBAY94001 / I001 / 1,000 pcs

**SAMSUNG** **c7u** **us** **ERC**





**주의 사항**

이 알루미늄 지퍼 백은 습기 및 정전기로부터 제품을 보호하기 위하여 제작되었습니다. 개봉 후에는 즉시 솔더 작업을 실시하는 것을 권장합니다.

습기 및 정전기로부터 제품을 보호 하기 위해서 개봉 후 사용하지 않는 자재는 본 팩에 넣어 보관 하시기 바랍니다. 사용하지 않는 자재를 본 팩에 넣을 때는 반드시 동봉된 드라이 팩과 함께 넣고 지퍼부분을 완전하게 밀봉하여 주시기 바랍니다.

**Important**

This Al Zipper bag is designed to protect the enclosed products from moisture and ESD. Once opened, the products should be soldered onto the printed circuit board immediately. When not in use, please do not leave the products unprotected by the Al Zipper Bag. To repack unused products., please ensure the zip-lock is completely sealed with the dry pack left inside.

c) Silica Gel & Humidity Indicator Card inside Aluminum Vinyl Bag



DESICCANT  
**SILICA**  
DO NOT  
OPEN  
GEL  
SIL

**HUMISAFE™** **HUMIDITY INDICATOR COBALT-FREE**

10%

20%

30%

40%

50%

60%



READ AT TOP OF GREEN COLOR  
CHANGE BETWEEN YELLOW AND GREEN



Warning if Green  
Change Desiccant









GP&E Co., Ltd.  
6CF-60NS



## 10. Precautions in Handling & Use

- 1) For over-current protection, users are recommended to apply resistors connected in series with the LEDs to mitigate sudden change of the forward current caused by shift of forward voltage.
- 2) This device should not be used in any type of fluid such as water, oil, organic solvent, etc. When cleaning is required, IPA is recommended as the cleaning agent. Some solvent-based cleaning agent may damage the silicone resins used in the device.
- 3) When the device is in operation, the forward current should be carefully determined considering the maximum ambient temperature and corresponding junction temperature.
- 4) LEDs must be stored in a clean environment. If the LEDs are to be stored for three months or more after being shipped from Samsung, they should be packed with a nitrogen-filled container (shelf life of sealed bags is 12 months at temperature 0~40 °C, 0~90 % RH).
- 5) After storage bag is opened, device subjected to soldering, solder reflow, or other high temperature processes must be:
  - a. Mounted within 672 hours (28 days) at an assembly line with a condition of no more than 30 °C / 60 % RH, or
  - b. Stored at <10 % RH
- 6) Repack unused devices with anti-moisture packing, fold to close any opening and then store in a dry place.
- 7) Devices require baking before mounting, if humidity card reading is >60 % at 23 ± 5 °C.
- 8) Devices must be baked for 1 hour at 60 ± 5 °C, if baking is required.
- 9) The LEDs are sensitive to the static electricity and surge current. It is recommended to use a wrist band or anti-electrostatic glove when handling the LEDs. If voltage exceeding the absolute maximum rating is applied to LEDs, it may cause damage or even destruction to LED devices. Damaged LEDs may show some unusual characteristics such as increase in leakage current, lowered turn-on voltage, or abnormal lighting of LEDs at low current.
- 10) VOCs (Volatile Organic Compounds) can be generated from adhesives, flux, hardener or organic additives used in luminaires (fixtures). Transparent LED silicone encapsulant is permeable to those chemicals and they may lead to a discoloration of encapsulant when they exposed to heat or light. This phenomenon can cause a significant loss of light emitted (output) from the luminaires. In order to prevent these problems, we recommend users to know the physical properties of materials used in luminaires and they must be carefully selected.

# Legal and additional information.

## [About Samsung Electronics Co., Ltd.](#)

Samsung Electronics Co., Ltd. inspires the world and shapes the future with transformative ideas and technologies, redefining the worlds of TVs, smartphones, wearable devices, tablets, cameras, digital appliances, printers, medical equipment, network systems and semiconductors.

We are also leading in the Internet of Things space through, among others, our Digital Health and Smart Home initiatives. We employ 307,000 people across 84 countries. To discover more, please visit our official website at [www.samsung.com](http://www.samsung.com) and our official blog at [global.samsungtomorrow.com](http://global.samsungtomorrow.com).

Copyright © 2016 Samsung Electronics Co., Ltd. All rights reserved.  
Samsung is a registered trademark of Samsung Electronics Co., Ltd.  
Specifications and designs are subject to change without notice. Non-metric weights and measurements are approximate. All data were deemed correct at time of creation. Samsung is not liable for errors or omissions. All brand, product, service names and logos are trademarks and/or registered trademarks of their respective owners and are hereby recognized and acknowledged.

Samsung Electronics Co., Ltd.  
1, Samsung ro  
Giheung-gu  
Yongin-si, Gyeonggi-do, 17113  
KOREA

[www.samsungled.com](http://www.samsungled.com)

**SAMSUNG**