

EtherCAT



## ECAT-2016N

EtherCAT Slave I/O Module with 1-channel Strain Gauge

### Features

- On the fly processing: EtherCAT
- Powerful MCU handles efficient network traffic
- 2 x RJ-45 bus interface
- Distance between stations up to 100 m (100 BASE-TX)
- Support daisy chain connection
- EtherCAT conformance test tool verified
- Removable terminal block connector
- LED indicators
- 1 channel loadcell transducer Input
- RoHS compliant
- ESD Protection 4 KV Contact for each channel



### Introduction

The ECAT-2000 is equipped with the EtherCAT protocol and installed by daisy chain connection which permits the flexibility in devices installation and reduces infrastructure and operation costs. All the modules can be deployed in the network topologies such as star, line or ring. The isolation input and output design protects the ECAT-2000 against the harmful interference and environment.

The ECAT-2016N is 1-channels analog input terminal permits direct connection of a resistor bridge. Users can obtain the input status via the process data. It has passed and verified by the conformance test tool, therefore eligible EtherCAT Master or configuration can manipulate it simply and implement your various applications easily.

\* EtherCAT® is registered trademark and patented technology, licensed by Beckhoff Automation GmbH, Germany.

### Hardware Specifications

Strain Gauge Input	
Channels	1
Sensor	Full-Bridge
Resolution	16-bit
Accuracy	±0.1% of FSR
Input Range	±1.25 V, ±600 mV, ±300 mV, ±125 mV, ±80 mV, ±60 mV, ±40 mV, ±30 mV, ±20 mV, ±15 mV, ±10 mV
Sampling Rate	1k Hz per channel
Input Impedance	20 MΩ
Excitation Voltage	
Channel	1
Output Voltage	10 V
Max. Load Current	40 mA
EMS Protection	
ESD (IEC 61000-4-2)	±4 kV Contact for Each Terminal
EFT (IEC 61000-4-4)	Signal: 1 KV Class A; Power: 1 KV Class A
Surge (IEC 61000-4-5)	1 KV Class A
Power	
Input Voltage Range	+10 ~ +30 Vdc
Power Consumption	4 W Max.
Mechanical	
Dimensions (W x L x H)	33 mm x 127 mm x 108 mm
Installation	DIN-Rail Mounting
Casing	Plastic
Environment	
Operating Temperature	-25 ~ +75°C
Storage Temperature	-30 ~ +80°C
Relative Humidity	10 ~ 90% RH, Non-condensing

## Pin Assignments

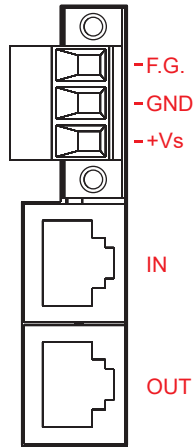
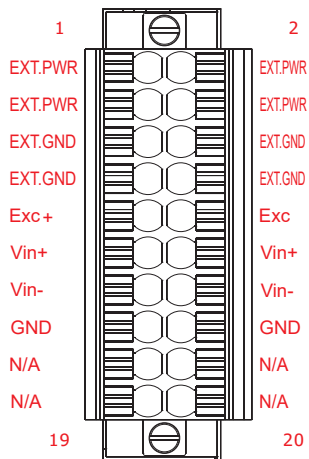

## Wire Connections

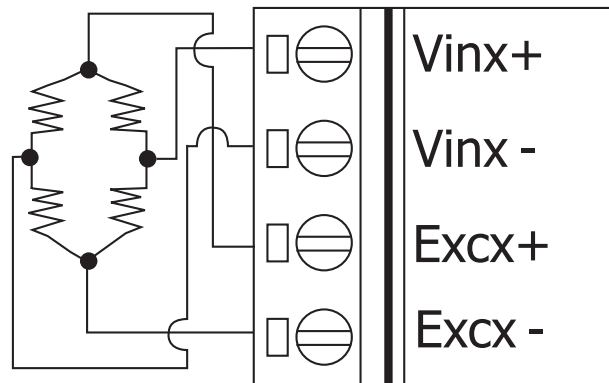

## Dimensions (Units: mm)

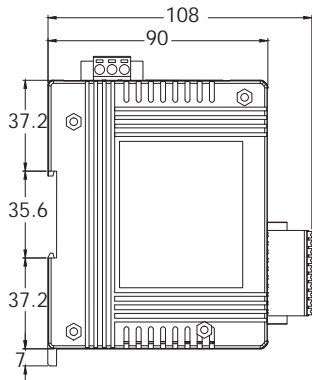

Left Side View

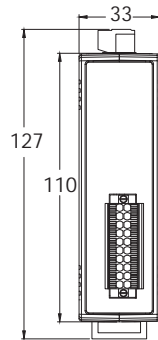

Front View

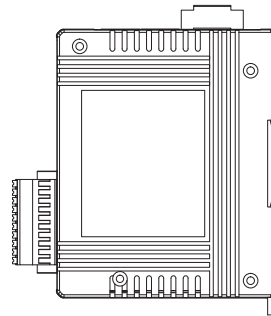

Right Side View

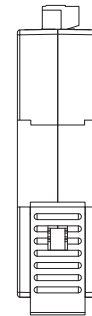

Rear View

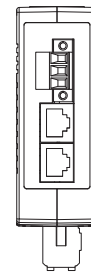

Top View

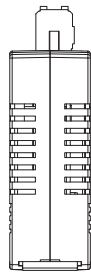

Bottom View

## Ordering Information

**ECAT-2016N CR**

EtherCAT Slave I/O Module with 1-channel Strain Gauge (RoHS)