



LMS78_1.0R Series

Wide Input Non-Isolated & Regulated, Single Positive/Negative Output

Switching Regulator

- ⊕ Efficiency up to 96%
- ⊕ Operating temperature: -40°C ~ +85°C
- ⊕ Pin-out compatible with LM78xx linear regulator
- ⊕ Short circuit protection (SCP)
- ⊕ No-load input current as low as 0.1mA
- ⊕ Low ripple and noise
- ⊕ Subminiature SIP package
- ⊕ Meeting UL60950, EN60950 standards
- ⊕ No heatsink required
- ⊕ Industry standard pinout
- ⊕ MTBF>2,000,000 hours
- ⊕ Supporting negative output perfectly

The LMS78_1.0R series are high efficiency switching regulators and ideal substitutes of LM78XX series three-terminal linear regulators.

The product is featured with high efficiency, low loss, low radiation and no heat sink requirement. They are widely used in industrial control, instrumentation, and electric power applications.



Common specifications	
Short circuit protection:	Continuous, automatic recovery
No-load power consumption:	0.1mA TYP, 1mA MAX
Reverse Polarity Input:	Forbidden
Input Filter:	Capacitor Filter
Temperature rise at full load:	25°C MAX, 15°C TYP
Cooling:	Free air convection
Operation temperature range:	-40°C~+85°C Power derating above 71°C
Storage temperature range:	-55°C ~+125°C
Pin welding resistance temperature:	260°C MAX, 1.5mm from case for 10 sec
Operating case temperature:	100°C
Storage humidity range:	< 95%RH
Package material:	Plastic [UL94-V0]
MTBF:	>2,000,000 hours +25°C MIL-HDBK-217F
Weight:	3.8g

Output specifications						
Item	Test conditions	Min	Typ	Max	Units	
Output voltage accuracy	100% load		±2	±4	%	
	• LMS78_03-1.0R • others		±2	±3	%	
Line regulation	Input Voltage Range		±0.2	±0.4	%	
Load regulation	10% to 100% load		±0.4	±0.6	%	
Ripple + Noise*	20MHz Bandwidth		20	75	mVp-p	
Switching frequency	• 3.3V/5V output	420	520	620	KHz	
	• others	580	680	780	KHz	
Transient response deviation	Nominal input, 25% load step change		50	300	mV	
Transient recovery time	Nominal input, 25% load step change		0.1	1	ms	
Temperature coefficient	-40 °C to +85 °C ambient			±0.03	%/°C	

* Test ripple and noise by "parallel cable" method. With the load lower than 10%, maximum ripple and noise will be 150mVp-p.

Note:

- The max. capacitive load should be tested within the input voltage range and under full load conditions;
- Without any special statement, all indexes are only specific to positive output application;
- Unless otherwise specified, data in this datasheet should be tested under the conditions of Ta = 25°C, humidity <75% when inputting nominal voltage and outputting rated load;
- All index testing methods in this datasheet are based on our Company's corporate standards;
- The performance indexes of the product models listed in this manual are as above, but some indexes of non-standard model products will exceed the above-mentioned requirements, and please directly contact with our technician for specific information;
- Specifications subject to change without prior notice.

Example:

LMS78_05-1.0RL

LM = Series; S = SIP Case; 05 = 5Vout; 1.0 = 1.0A; R = Revised; L = Banded Pins

EMC specifications

EMI	CE	CISPR22/EN55022	CLASS B	(External circuit refer to EMC recommended circuit,②)
EMI	RE	CISPR22/EN55022	CLASS B	(External circuit refer to EMC recommended circuit,②)
EMS	ESD	IEC/EN61000-4-2	Contact ±4KV	perf. Criteria B
EMS	RS	IEC/EN61000-4-3	10V/m	perf. Criteria A
EMS	EFT	IEC/EN61000-4-4	±1KV	perf. Criteria B (External circuit refer to EMC recommended circuit,①)
EMS	Surge	IEC/EN61000-4-5	±1KV	perf. Criteria B (External circuit refer to EMC recommended circuit,①)
EMS	CS	IEC/EN61000-4-6	3 Vr.m.s	perf. Criteria A

LMS78_1.0R Series

Wide Input Non-Isolated & Regulated, Single Positive/Negative Output

Part Number	Input Voltage [VDC] Nominal (Range)	Output Voltage [VDC]	Output Current [mA]	Efficiency [%, min/max]	Max. capacitive load [μF]
LMS78_03-1.0R	24 (6-36)	3.3	1000	90/81	680
LMS78_05-1.0R	24 (8-36) 12 (8-27)	5.0 -5.0	1000 -500	93/86 86/82	680 330
LMS78_09-1.0R	24 (13-36)	9.0	1000	95/90	680
LMS78_12-1.0R	24 (16-36) 12 (8-20)	12 -12	1000 -300	96/93 89/88	680 330
LMS78_15-1.0R	24 (20-36) 12 (8-18)	15 -15	1000 -300	96/94 89/89	680 330

Add suffix "L" for 90° bend pins, for example: LMS78_05-1.0RL.

Typical characteristics

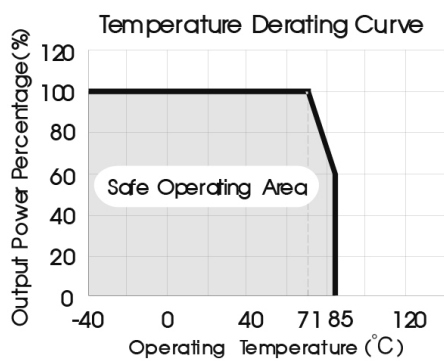

Typical application circuit

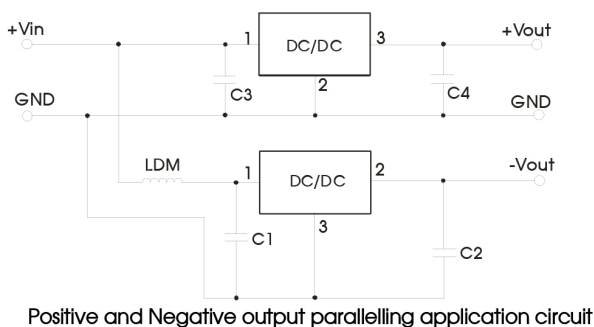
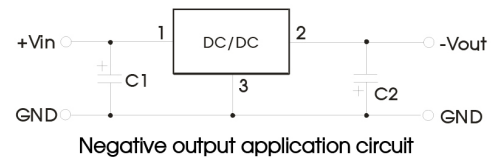
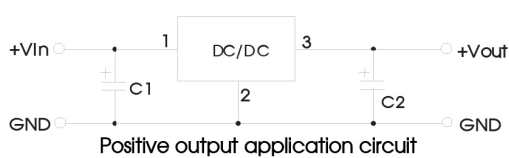

Part Number	C1,C3 (Ceramic Capacitor)	C2,C4 (Ceramic Capacitor)
LMS78_03-1.0R	10μF/50V	22μF/10V
LMS78_05-1.0R	10μF/50V	22μF/10V
LMS78_09-1.0R	10μF/50V	10μF/16V
LMS78_12-1.0R	10μF/50V	10μF/25V
LMS78_15-1.0R	10μF/50V	10μF/25V

Note:

1. C1 and C2 (C3 and C4) are required and should be connected close to the pin terminal of the module.
2. The capacitance of C1 and C2 (C3 and C4) refer to Sheet 1.
3. To reduce the output ripple furtherly, C2 and C4 can be increased properly if required, and tantalum or low ESR electrolytic capacitors may also suffice.
4. When the products used as positive and negative output paralleling application circuit, an inductor named as LDM up to 10μH is recommended in the circuit to reduce the mutual interference.
5. Cannot be used in parallel for output and hot swap.

LMS78_1.0R Series

Wide Input Non-Isolated & Regulated, Single Positive/Negative Output

Standard application circuit

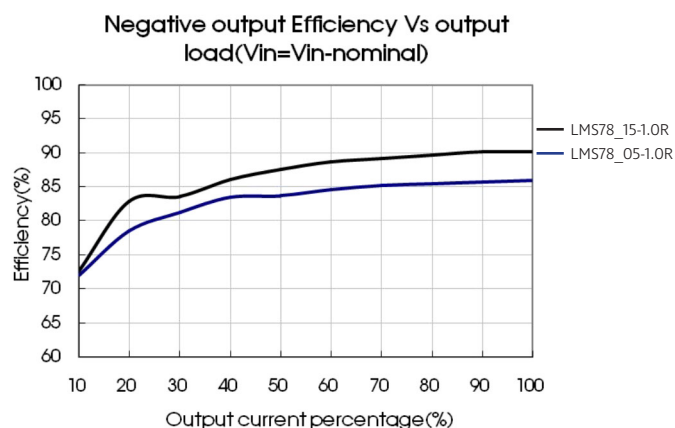
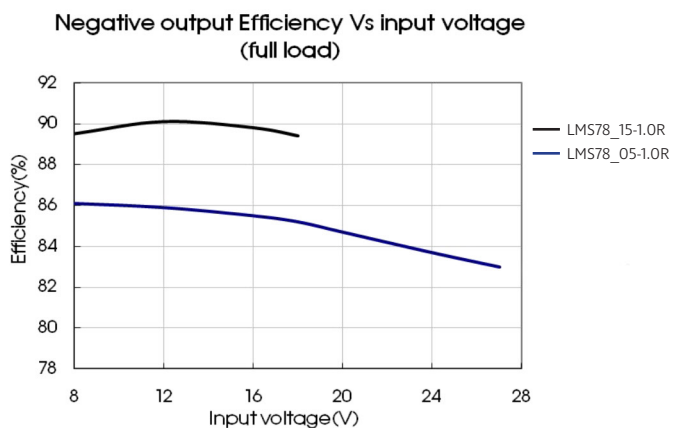
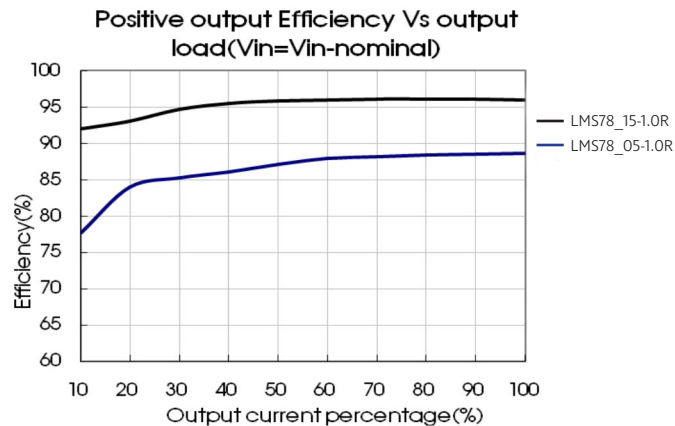
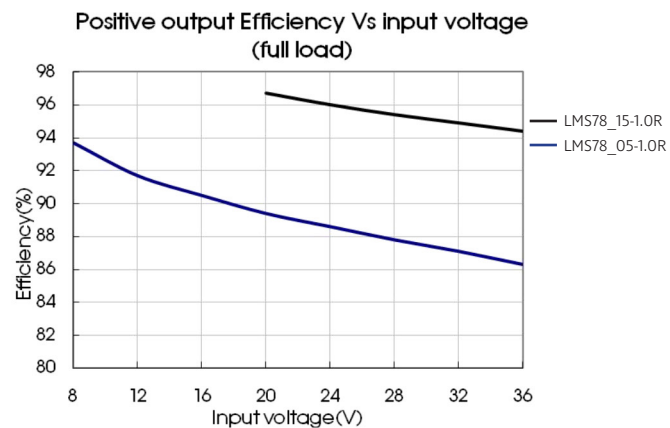

EMC solution-recommended circuit

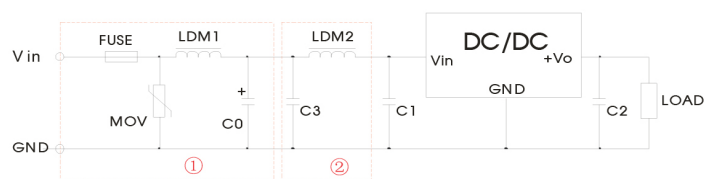

Part ① is for EMS test, part ② is for EMI filtering; parts ① and ② can be added based on actual requirement.

FUSE	MOV	LDM1	C0	C1/C2	C3	LDM2
Selected based on the actual input current from the customer	S20K30	82μH	680μF /50V	Refer to positive output application circuit	4.7μF /50V	12μH

LMS78_1.0R Series

Wide Input Non-Isolated & Regulated, Single Positive/Negative Output

Mechanical dimension and footprint

LMS78_xx-1.0R

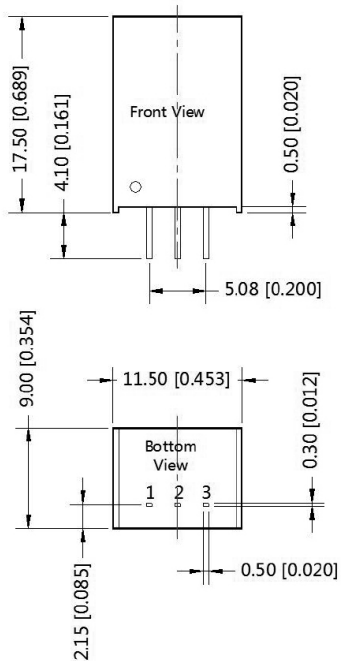

LMS78_xx-1.0RL

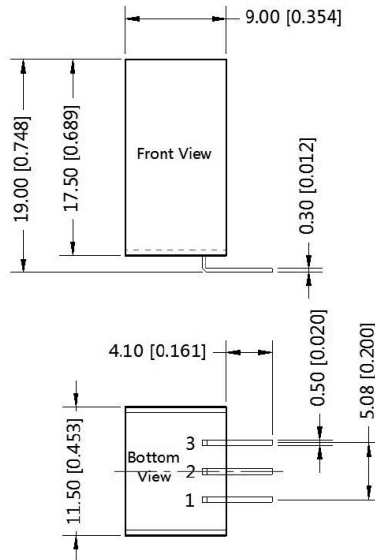

LMS78_xx-1.0R

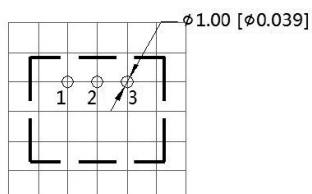

LMS78_xx-1.0R

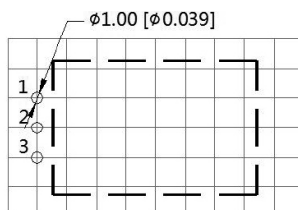

Note : Grid 2.54*2.54mm

Pin-Out		
Pin	+Output	-Output
1	Vin	Vin
2	GND	-Vo
3	+Vo	GND

Note:
Unit :mm[inch]
Pin diameter tolerances : ± 0.10 [± 0.004]
General tolerances: ± 0.25 [± 0.010]