

ROSE-MRK-S

~30° spot beam. Assembly with white holder.

SPECIFICATION:

Dimensions	21.6 x 21.6 mm
Height	13 mm
Fastening	tape, pin
ROHS compliant	yes ⓘ

MATERIALS:

Component	Type	Material	Colour	Finish
ROSE-MRK-S	Single lens	PC	clear	
ROSE-MRK-LT-HLD	Holder	PC	white	
ROSE-TAPE	Tape	Acrylic foam	black	







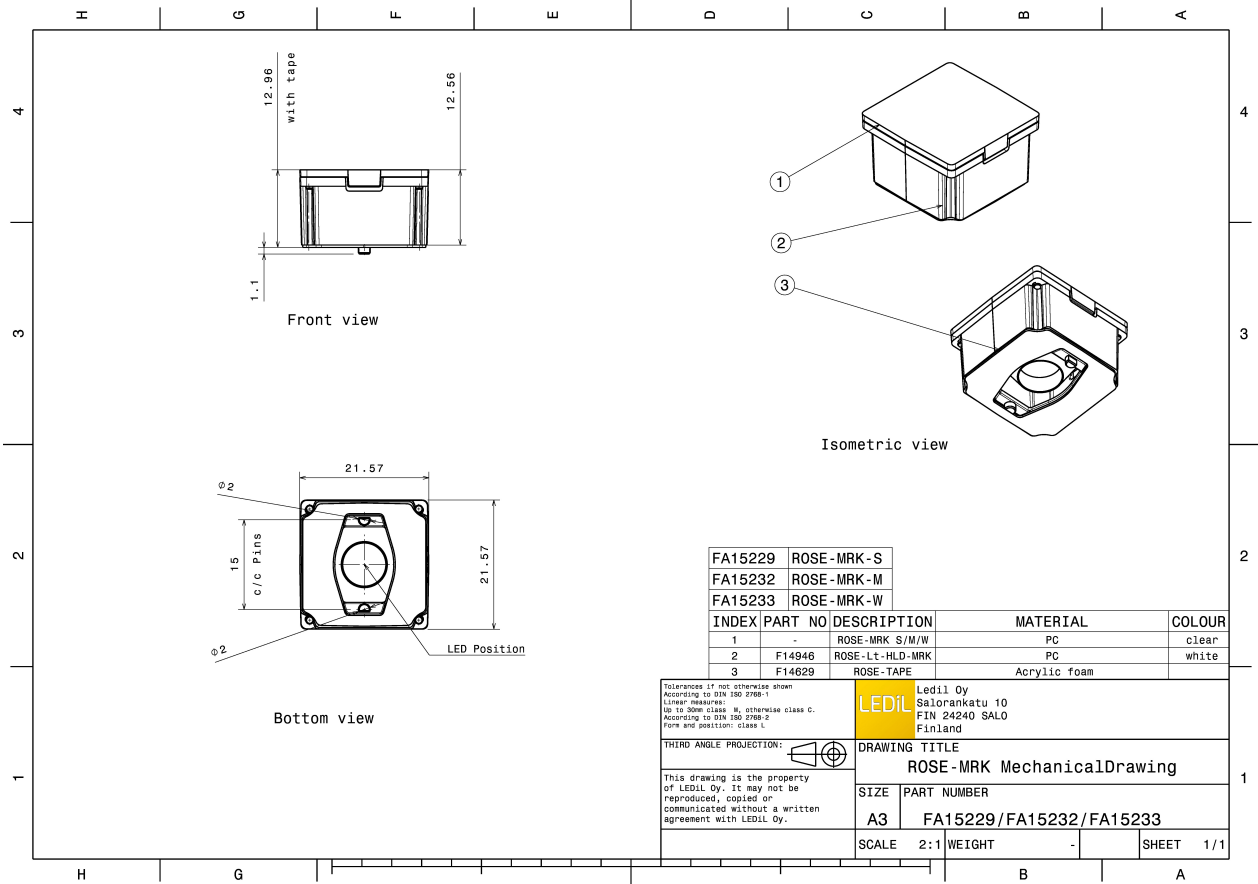

ORDERING INFORMATION:

Component	Type	Qty in box	MOQ	MPQ	Box weight (kg)
FA15229_ROSE-MRK-S	Single lens	2304	288	144	9.5
» Box size: 457 x 260 x 260 mm					

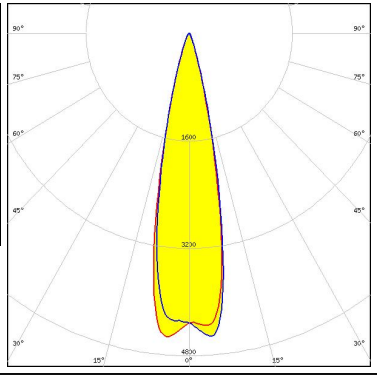

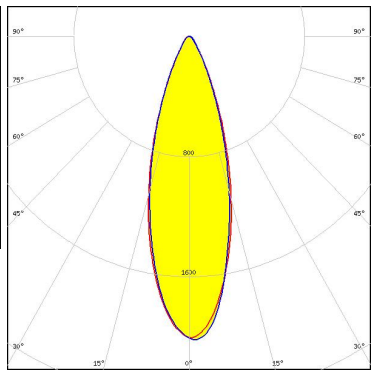
See also our general installation guide: www.ledil.com/installation_guide

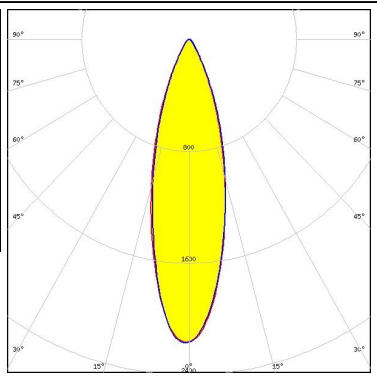
OPTICAL RESULTS (MEASURED):

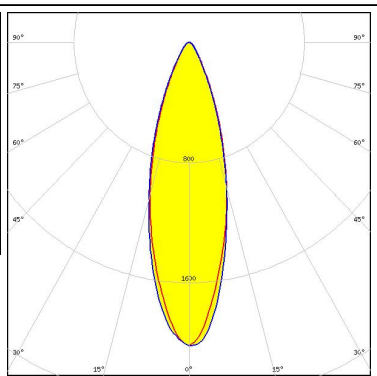
<p>CREE LED</p> <p>LED XP-E2 FWHM / FWTM 23.0° / 38.0° Efficiency 86 % Peak intensity 4.6 cd/lm LEDs/each optic 1 Light colour White Required components:</p>		
<p>LUMILEDS</p> <p>LED LUXEON 5050 Round LES FWHM / FWTM 33.0° / 61.0° Efficiency 86 % Peak intensity 2 cd/lm LEDs/each optic 1 Light colour White Required components:</p>		
<p>LUMILEDS</p> <p>LED LUXEON M/MX FWHM / FWTM 29.0° / 61.0° Efficiency 86 % Peak intensity 2.2 cd/lm LEDs/each optic 1 Light colour White Required components:</p>		
<p>OSRAM <small>Opto Semiconductors</small></p> <p>LED Duris S8 FWHM / FWTM 31.0° / 62.0° Efficiency 86 % Peak intensity 2 cd/lm LEDs/each optic 1 Light colour White Required components:</p>		

OPTICAL RESULTS (MEASURED):

OSRAM
Opto Semiconductors

LED OSLON SSL 150
FWHM / FWTM 23.0° / 39.0°
Efficiency 85 %
Peak intensity 4.4 cd/lm
LEDs/each optic 1
Light colour White
Required components:

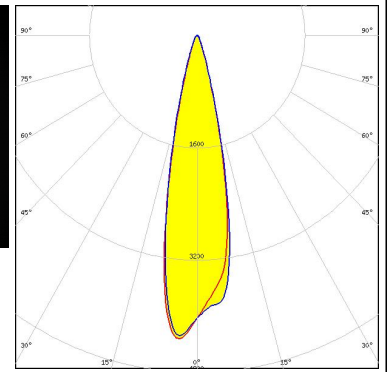

OPTICAL RESULTS (SIMULATED):

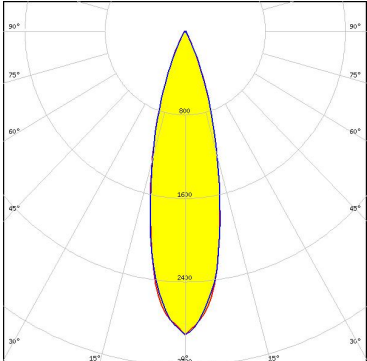
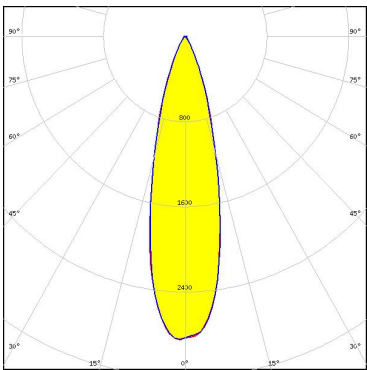
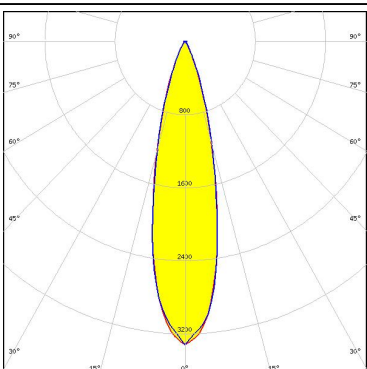
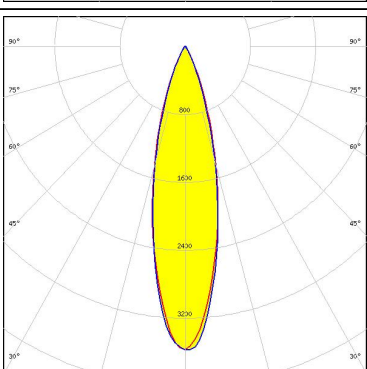
<p>CREE → LED</p> <p>LED: XHP50 FWHM / FWTM: 27.0° / 50.0° Efficiency: 87 % Peak intensity: 2.9 cd/lm LEDs/each optic: 1 Light colour: White Required components:</p>	
<p>CREE → LED</p> <p>LED: XHP50.2 FWHM / FWTM: 26.0° / 52.0° Efficiency: 85 % Peak intensity: 2.9 cd/lm LEDs/each optic: 1 Light colour: White Required components:</p>	
<p>CREE → LED</p> <p>LED: XHP50.3 HD FWHM / FWTM: 24.0° / 48.0° Efficiency: 85 % Peak intensity: 3.3 cd/lm LEDs/each optic: 1 Light colour: White Required components:</p>	
<p>LUMILEDS</p> <p>LED: LUXEON 5050 Square LES FWHM / FWTM: 26.0° / 50.0° Efficiency: 95 % Peak intensity: 3.6 cd/lm LEDs/each optic: 1 Light colour: White Required components:</p>	

OPTICAL RESULTS (SIMULATED):



LED SST-20
FWHM / FWTM 18.0° / 32.0°
Efficiency 87 %
Peak intensity 7.3 cd/lm
LEDs/each optic 1
Light colour White
Required components:

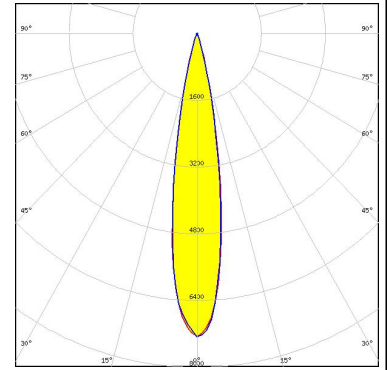

LED NFMW48xA
FWHM / FWTM 23.0° / 49.0°
Efficiency 88 %
Peak intensity 3.7 cd/lm
LEDs/each optic 1
Light colour White
Required components:

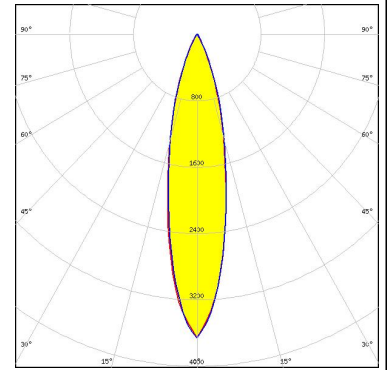

LED NV4x144A
FWHM / FWTM 26.0° / 50.0°
Efficiency 85 %
Peak intensity 3 cd/lm
LEDs/each optic 1
Light colour White
Required components:

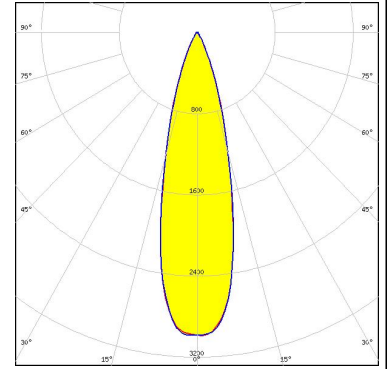

GENERAL INFORMATION:

NOTE: The typical beam angle will be changed by different color, chip size and chip position tolerance. The typical total beam angle is the full angle measured where the luminous intensity is half of the peak value.

MATERIALS:

As part of our continuous research and improvement processes, and to ensure the best possible quality and availability of our products, LEDiL reserves the right to change material grades without notice.

PRODUCT DATA USER AGREEMENT AND DISCLAIMER:

The measured data in the provided downloadable LEDiL Product Datasheets and Mechanical 2D-Drawings is rounded and provided as reference for planning. LEDiL Oy's optical specifications have been verified by conducting performance testing of the products in accordance with the company's quality system. The reported data are averaged results of multiple measurements with typical variation. LEDiL Oy reserves the right to without prior notification make changes and improvements to its products.

LEDiL Oy assumes neither warranty, nor guarantee nor any other liability of any kind for the contents and correctness of the provided data. The provided data has been generated with highest diligence but the provided data may in reality not represent the complete possible variation range of all intrinsic parameters. Therefore, in certain cases a deviation from the provided data could occur.

LEDiL Oy reserves the right to undertake technical changes of its products without further notification which could lead to changes in the provided data. LEDiL Oy assumes no liability of any kind for the possible deviation from any provided data or any other damage resulting from the usage of the provided data.

The user agrees to this disclaimer and user agreement with the download or usage of the provided files.

LEDiL Oy

Joensuunkatu 13
FI-24240 SALO
Finland

LEDiL Inc.

228 West Page Street
Suite D
Sycamore IL 60178
USA

Ledil Optics Technology (Shenzhen) Co., Ltd.

405 , Block B
Casic Motor Building
Shenzhen 518057
P.R.CHINA

Local sales and technical support

[www.ledil.com/
where_to_buy](http://www.ledil.com/where_to_buy)

Shipping locations

Salo, Finland
Hong Kong, China

Distribution Partners

[www.ledil.com/
where_to_buy](http://www.ledil.com/where_to_buy)