

## ANT-915-CPA

### 915 MHz Directional Embedded Ceramic Patch Antenna

The 915-CPA compact ceramic patch antenna offers directional signaling at 915 MHz with a footprint of only 25 mm x 25 mm on a recommended ground plane size of 40 mm x 40 mm.

The 915-CPA antenna is ideal for RFID and hand-held applications and other 915 MHz ISM band applications where directional signaling is desired.

The 915-CPA antenna mounts to the printed circuit board (PCB) using re-peelable 5000NS adhesive backing which allows for repositioning or reorientation of the antenna. The pin-type connection feeds through the PCB where it is soldered to the feed line.



#### Features

- Directional radiation pattern orthogonal to antenna surface
- Compact size, 25 mm x 25 mm x 4 mm
- Peak gain: 1.5 dBi when used with a 40 mm x 40 mm ground plane. Larger ground planes provide increased gain performance
- Pin-mount solder connection for direct PCB attachment
- Right-hand circularly polarized (RHCP)
- Durable re-peelable self-adhesive backing

#### Applications

- Smart Home networking
  - Security systems
  - Home weather stations
- Remote sensing, monitoring and control
  - Security systems
  - Industrial machinery
  - Keyless entry systems
  - UHF RFID devices
- Hand-held devices
- Low-power, wide-area (LPWA) applications
  - LoRaWAN®
  - Sigfox®

#### Ordering Information

Part Number	Description
ANT-915-CPA	915 MHz ceramic patch antenna

Available from Linx Technologies and select distributors and representatives.

Electrical Specifications

Frequency Range	915 MHz
VSWR (max.)	1.2
Return Loss (max.)	-21.1
Peak Gain (dBi)	1.5
Average Gain (dBi)	-9.7
Efficiency (%)	23
Polarization	RHCP
Radiation	Directional
Max Power	8 W
Wavelength	1/4-wave
Electrical Type	Radiating patch
Impedance	50 Ω
Connection	Pin type
Weight	13.2 g (0.46 oz)
Dimensions	25.0 mm x 25.0 mm x 4.0 mm (1.00 in x 1.00 in x 0.16 in)
Operating Temperature Range	-40 °C to +85 °C
ESD Sensitivity	NOT ESD sensitive. As a best practice, Linx may use ESD packaging.

Electrical specifications and plots measured with a 40 mm x 40 mm (1.6 in x 1.6 in) ground plane

Product Dimensions

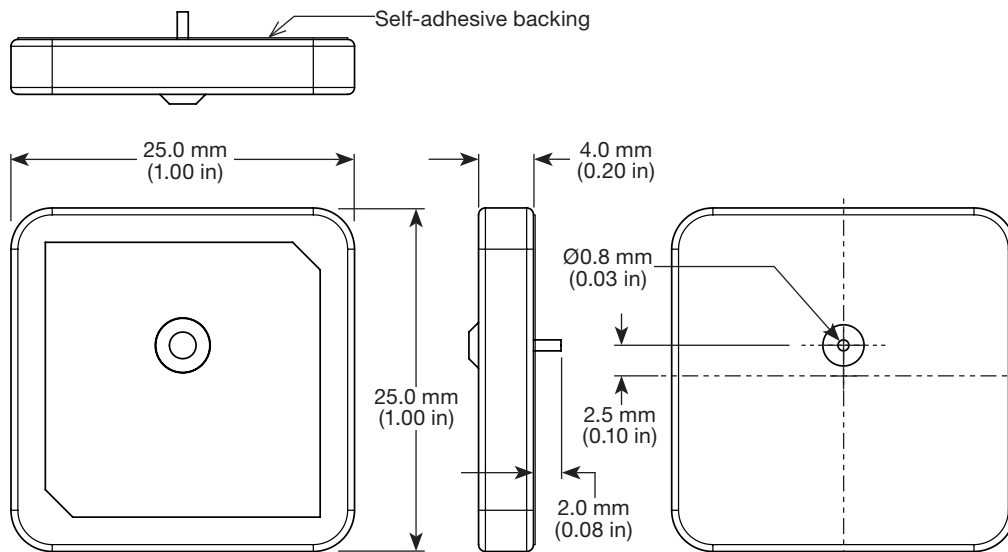

Figure 1. 915-CPA Antenna Dimensions

Ground Plane

Ceramic patch antennas are directional in signal transmission and reception orthogonal to the surface plane of the antenna, and require a ground plane for proper operation. The larger the ground plane, the narrower the antenna signal beam, and generally, the better the VSWR performance of the antenna. Relatively smaller ground planes produce wider signal beams. Linx recommends the ground plane size shown in the Electrical Specifications table to achieve performance similar to that shown in this datasheet.

### VSWR

Figure 2 provides the voltage standing wave ratio (VSWR) across the antenna bandwidth. VSWR describes the power reflected from the antenna back to the radio. A lower VSWR value indicates better antenna performance at a given frequency. Reflected power is also shown on the right-side vertical axis as a gauge of the percentage of transmitter power reflected back from the antenna.

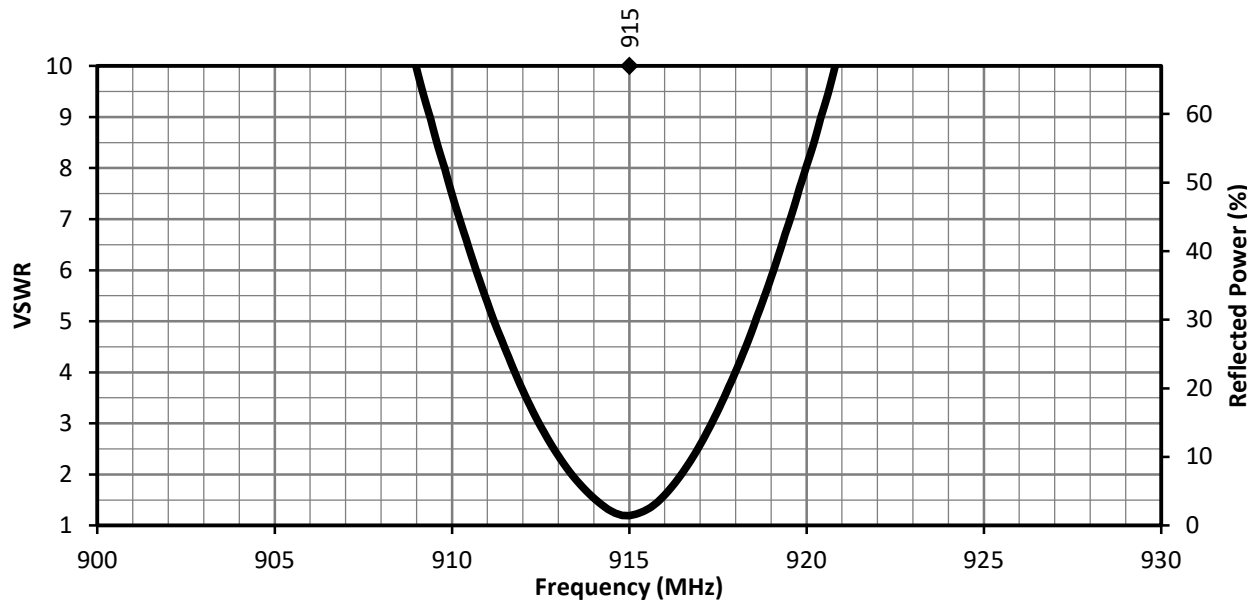

Figure 2. 915-CPA VSWR

### Return Loss

Return loss (Figure 3), represents the loss in power at the antenna due to reflected signals. Like VSWR, a lower return loss value indicates better antenna performance at a given frequency.

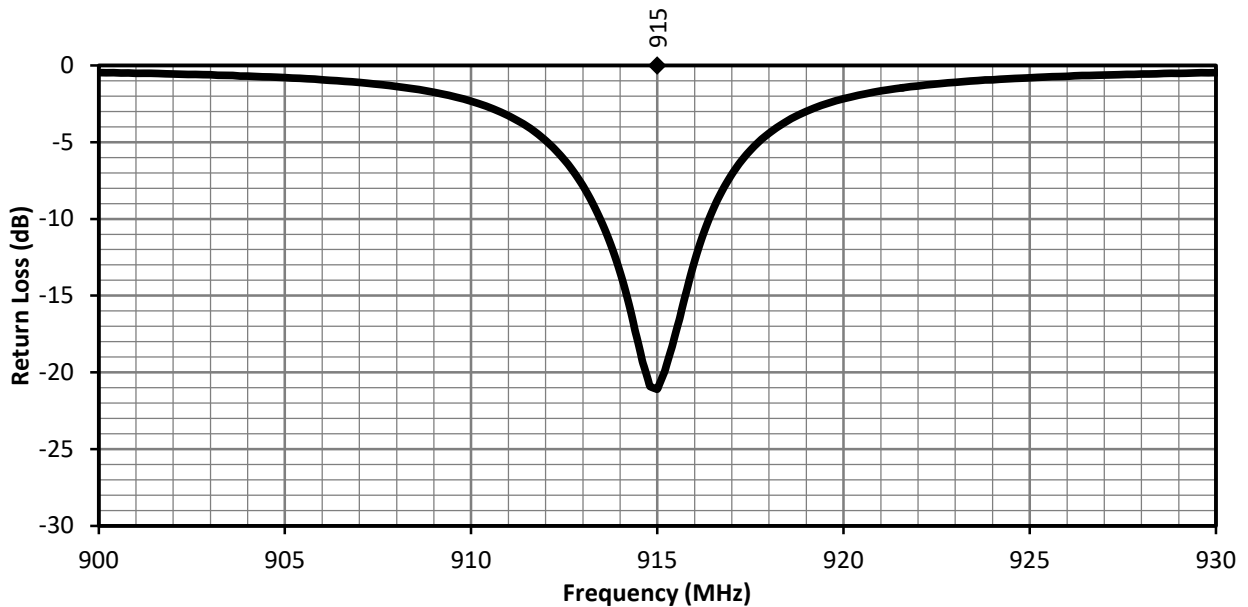

Figure 3. 915-CPA Return Loss

### Peak Gain

The peak gain across the antenna bandwidth is shown in Figure 4. Peak gain represents the maximum antenna input power concentration across 3-dimensional space, and therefore peak performance at a given frequency, but does not consider any directionality in the gain pattern.

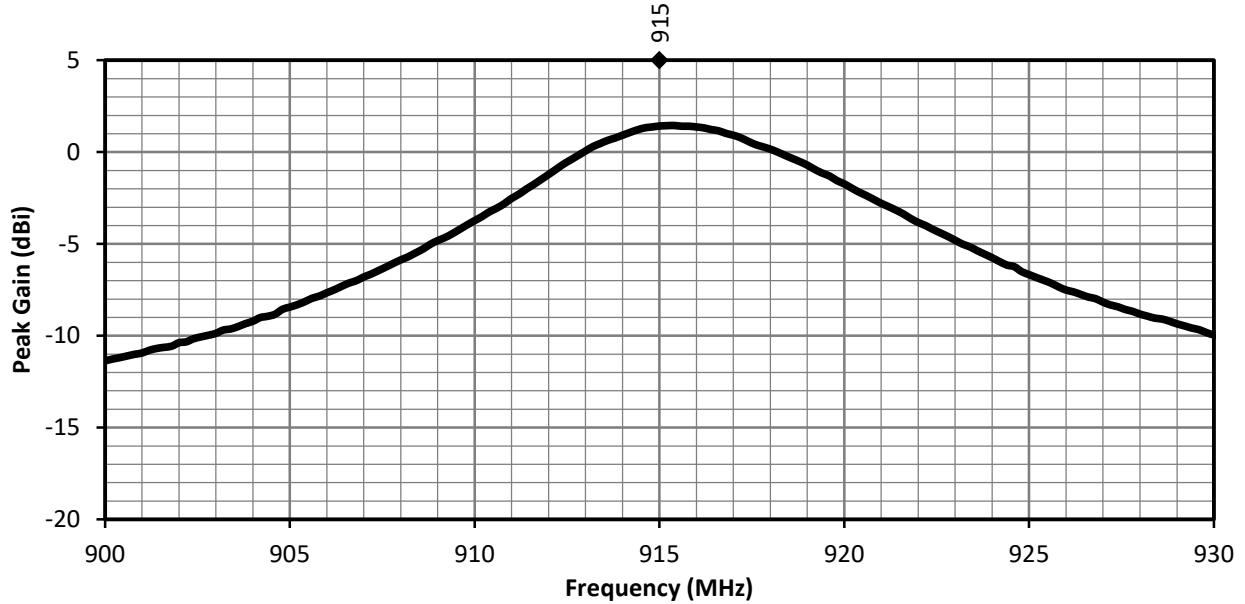

Figure 4. 915-CPA Peak Gain

### Radiation Efficiency

Radiation efficiency (Figure 5), shows the ratio of power delivered to the antenna relative to the power radiated at the antenna, expressed as a percentage, where a higher percentage indicates better performance at a given frequency.

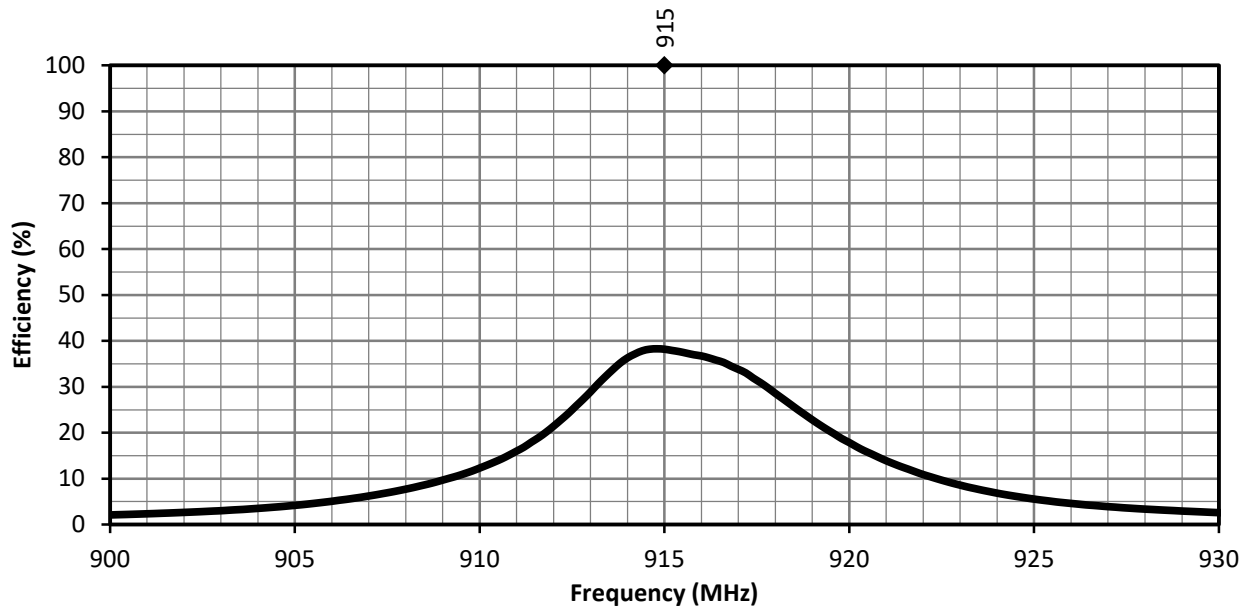
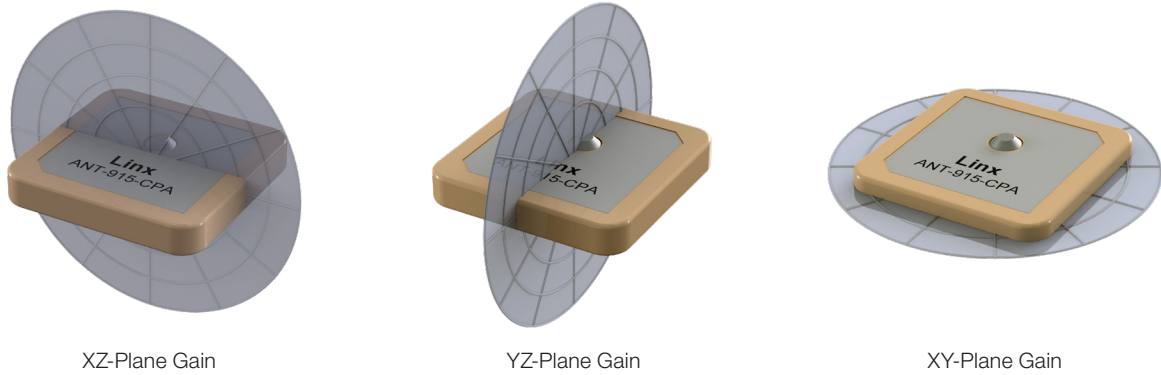

Figure 5. 915-CPA Antenna Radiation Efficiency

### Radiation Patterns

Radiation patterns provide information about the directionality and 3-dimensional gain performance of the antenna by plotting gain at specific frequencies in three orthogonal planes. Antenna radiation patterns are shown in Figure 6 using polar plots covering 360 degrees. The antenna graphic at the top of the page provides reference to the plane of the column of plots below it. Note: when viewed with typical PDF viewing software, zooming into radiation patterns is possible to reveal fine detail.



### 902 MHz to 928 MHz (915 MHz)

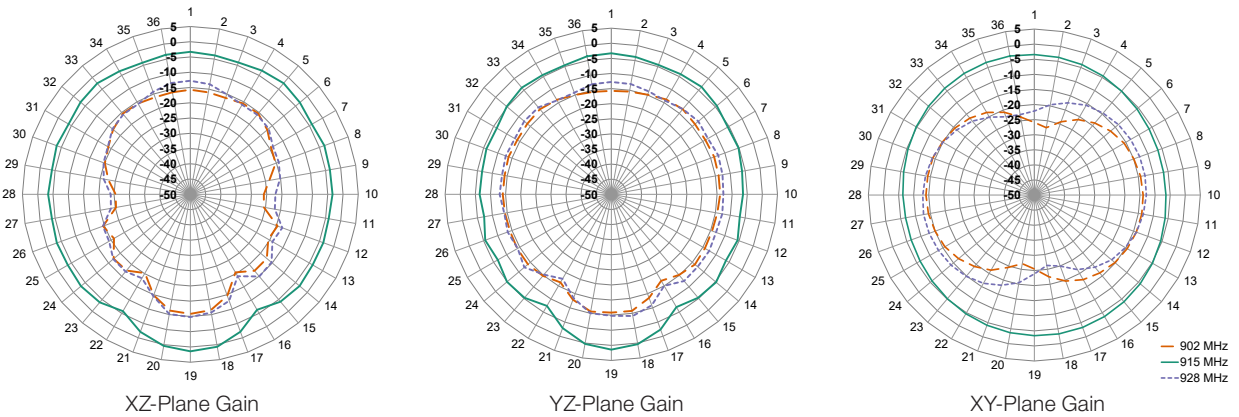

Figure 6. Radiation Patterns for 915-CPA Antenna

---

**Website:** <http://linxtechnologies.com>  
**Linx Offices:** 159 Ort Lane, Merlin, OR, US 97532  
**Phone:** +1 (541) 471-6256  
**E-MAIL:** [info@linxtechnologies.com](mailto:info@linxtechnologies.com)

---

Linx Technologies reserves the right to make changes to the product(s) or information contained herein without notice. No liability is assumed as a result of their use or application. No rights under any patent accompany the sale of any such product(s) or information.

Wireless Made Simple is a registered trademark of Linx Acquisitions LLC. LoRaWAN is a registered trademark of Semtech Corporation. Sigfox is a registered trademark of SIGFOX. Other product and brand names may be trademarks or registered trademarks of their respective owners.

Copyright © 2019 Linx Technologies

All Rights Reserved

Doc # DS19326-26ANT

