

ALC80C681EF400

Aliases (A547HH681M400C)

ALC80, Aluminum Electrolytic, 680 uF, 20%, 400 VDC, -40/+105°C

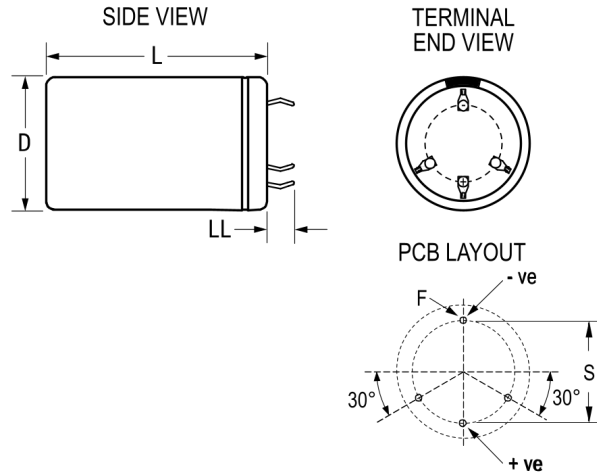

Click [here](#) for the 3D model.

Dimensions

D	40mm +1mm
L	50mm +/-2mm
S	22.5mm +/-0.1mm
LL	6.3mm +/-1mm
F	2mm +/-0.1mm

Packaging Specifications

Sleeving	Yes
Packaging	Bulk, Bag

General Information

Series	ALC80
Dielectric	Aluminum Electrolytic
Description	Snap-In, Aluminum Electrolytic
RoHS	Yes
Lead	4 Pin
AEC-Q200	No
Halogen Free	Yes
Component Weight	105 g
Notes	Dimensions D And L Include Sleeving.
Shelf Life	156 Weeks

Specifications

Capacitance	680 uF
Capacitance Tolerance	20%
Voltage DC	400 VDC, 440 VDC (Surge)
Temperature Range	-40/+105°C
Rated Temperature	105°C
Life	9000 Hrs (Rated Voltage and Ripple Current at 105C), 14000 Hrs (Rated Voltage at 105C)
Resistance	187.3 mOhms (100Hz 20C), 97.93 mOhms (10kHz 20C)
Ripple Current	3.356 Amps (100Hz 105C), 8.215 Amps (10kHz 105C)
Leakage Current	816 uA (5min 20°C)