

# EZLSA-TE Series Tubular Enclosure



## Datasheet

Tubular enclosures for EZ-SCREEN LS models mounted in washdown environments.

- FDA-grade polycarbonate tubing and acetal end caps
- Stainless steel mounting components
- Brackets and fasteners included
- Ideal for high-pressure washdown applications
- IEC IP67, IP69K
- Twenty-three models are available to accommodate EZ-SCREEN® LS models

The EZLSA-TE Series Tubular Enclosure is designed specifically for use with Banner EZ-SCREEN LS emitters and receivers. The enclosures are constructed of FDA-approved rugged polycarbonate tubing with FDA-approved acetal end caps. The enclosures are mounted with stainless steel mounting brackets and fasteners.

Using the enclosure affects the sensing range of the sensor used. When used in pairs, the range can be reduced by 30%.

When using the enclosure, you must use an RDLS cordset, which is sold separately. Refer to the EZ-SCREEN LS Instruction Manual (p/n [179480](#)) for a complete list of available cordsets.

Sensor Model	Tubular Enclosure Model	Sensor Model	Tubular Enclosure Model
SLL..-280..	EZLSA-TE-280	SLL..-1050..	EZLSA-TE-1050
SLL..-350..	EZLSA-TE-350	SLL..-1120..	EZLSA-TE-1120
SLL..-420..	EZLSA-TE-420	SLL..-1190..	EZLSA-TE-1190
SLL..-490..	EZLSA-TE-490	SLL..-1260..	EZLSA-TE-1260
SLL..-560..	EZLSA-TE-560	SLL..-1330..	EZLSA-TE-1330
SLL..-630..	EZLSA-TE-630	SLL..-1400..	EZLSA-TE-1400
SLL..-700..	EZLSA-TE-700	SLL..-1470..	EZLSA-TE-1470
SLL..-770..	EZLSA-TE-770	SLL..-1540..	EZLSA-TE-1540
SLL..-840..	EZLSA-TE-840	SLL..-1610..	EZLSA-TE-1610
SLL..-910..	EZLSA-TE-910	SLL..-1680..	EZLSA-TE-1680
SLL..-980..	EZLSA-TE-980	SLL..-1750..	EZLSA-TE-1750
		SLL..-1820..	EZLSA-TE-1820





**CAUTION:** Reduced Sensing Range—Sensing range is reduced 30% because of tubular construction.



**WARNING:** Maintain Required Separation Distance— The light screen produced by the optical safety system sensors must be placed at a minimum safe distance from the dangerous motion of the machine being guarded. This necessary minimum distance is called the separation distance, and is discussed in the instruction manual. Failure to calculate this distance correctly and to maintain minimum separation distance can result in serious injury.

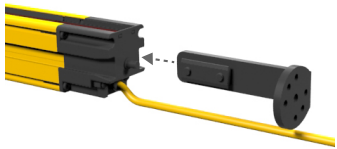
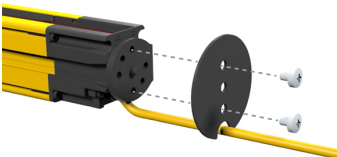
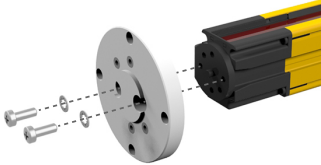
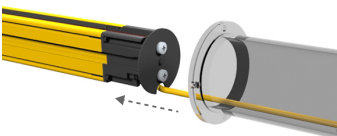

## Assembling the Tubular Enclosure

Step	Description	Illustration
1	<p>Install the long halves of the EZLSA-MBK-11 brackets onto both ends of the light curtain using the supplied hardware and t-nuts. The short halves of the EZLSA-MBK-11 brackets are not used in this application. The brackets should slide onto the light curtain until they mate with the end cap.</p> <p>Tighten the screws, but do not exceed a maximum torque of 36 in-lbs.</p>	
2	<p>With the cordset and the EZLSA-MBK-11 end brackets installed, fasten the spacer disk onto the bracket at the cabled end of the sensor using the two M5 × 6 mm stainless steel screws.</p> <p>Tighten the screws to a torque of 10 to 15 in-lbs.</p>	
3	<p>Verify the white gasket is pressed into the top cap and the through holes in the gasket are aligned with the through holes in the top cap.</p> <p>Reposition the gasket if necessary.</p> <p>Place an O-ring in the groove near the outside edge of the top cap.</p> <p>Screw the top cap onto the bracket at the non-cabled end of the sensor housing using the two M5 × 14 mm stainless steel screws and the internal tooth lock washers.</p> <p>Tighten the screws to a minimum torque of 20 in-lbs.</p>	
4	<p>Being careful not to scratch the tubular housing, slide the tube around the sensor beginning with the cabled end of the sensor and the non-labeled end of the tubular housing.</p> <p>Push the sensor through the housing until the cordset comes out the opening at the labeled end of the tube.</p>	

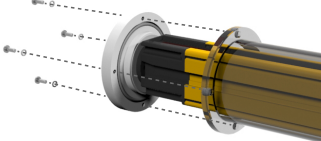
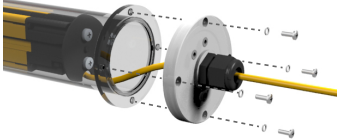
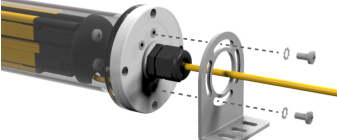
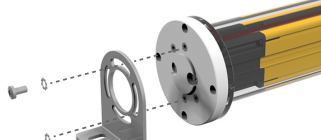
Step	Description	Illustration
5	<p>Screw the top cap to the flange on the clear tube using four #6-32 screws and split ring lock washers.</p> <p>Torque the screws between 10 and 15 in-lbs.</p>	
6	<p>Place the O-ring in the groove near the outside edge of the bottom cap, and slide the bottom end cap over the unterminated end of the cordset.</p> <p>Screw the bottom cap to the flange on the clear tube using the remaining four #6-32 screws and split ring lock washers.</p> <p>Torque the screws between 10 and 15 in-lbs. Tighten the strain relief nut around the cordset until the cable jacket is compressed.</p>	
7	<p>Place the mounting bracket on the bottom cap so the cordset passes through the center of it.</p> <p>Secure the bracket to the bottom cap using two #10-32 screws and external tooth lock washers.</p> <p>Tighten the screws, but do not exceed a maximum torque of 50 in-lbs.</p>	
8	<p>Place the second mounting bracket on the top cap and secure it with two #10-32 screws and external tooth lock washers.</p> <p>Tighten the screws, but do not exceed a maximum torque of 50 in-lbs.</p>	

## Adjacent Reflective Surfaces



### WARNING: Avoid Installation Near Reflective Surfaces

Avoid locating the defined area near a reflective surface; it could reflect sensing beam(s) around an object or person within the defined area, and prevent its detection by the EZ-SCREEN LS. Perform the trip test, as described in the manual, to detect such reflection(s) and the resultant optical short circuit. Failure to prevent reflection problems will result in incomplete guarding and could result in serious injury or death.

A reflective surface located adjacent to the defined area may deflect one or more beams around an object in the defined area. In the worst case, an optical short circuit may occur, allowing an object to pass undetected through the defined area.

This reflective surface may result from shiny surfaces or glossy paint on the machine, the workpiece, the work surface, the floor, or the walls. Beams deflected by reflective surfaces are discovered by performing the trip test and the periodic checkout procedures. To eliminate problem reflections:

- If possible, relocate the sensors to move the beams away from the reflective surface(s), being careful to maintain adequate separation distance
- Otherwise, if possible, paint, mask, or roughen the shiny surface to reduce its reflectivity
- Where these are not possible (as with a shiny workpiece or machine frame), determine the worst-case resolution resulting from the optical short circuit and use the corresponding depth penetration factor (Dpf or C) in the Safety Distance (Minimum Distance) formula; or mount the sensors in such a way that the receiver's field of view and/or the emitter's spread of light are restricted from the reflective surface
- Repeat the trip test to verify that these changes have eliminated the problem reflection(s). If the workpiece is especially reflective and comes close to the defined area, perform the trip test with the workpiece in place

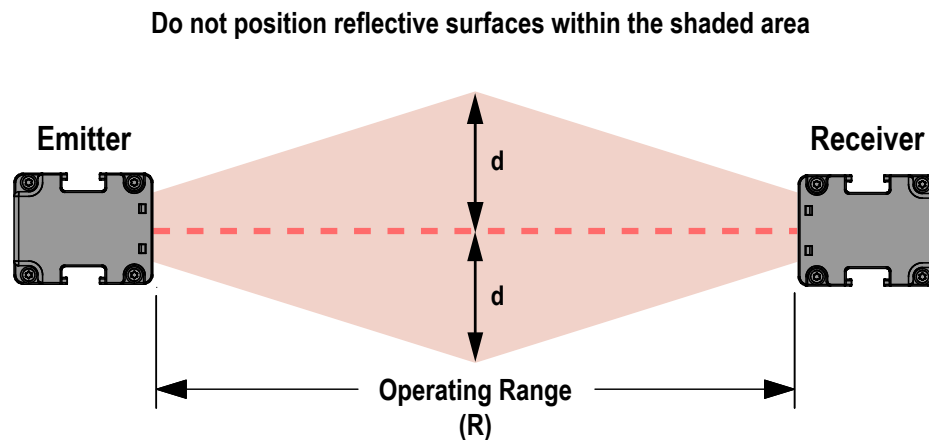

For 0.1 to 3 m (4 in to 10 ft) Operating range:  $d = 0.13 \text{ m (5 in)}$

For Operating range  $> 3 \text{ m (> 10 ft)}$ :  $d = 0.0437 \times R \text{ (m or ft)}$

Figure 1. Adjacent Reflective Surfaces

## Dimensions

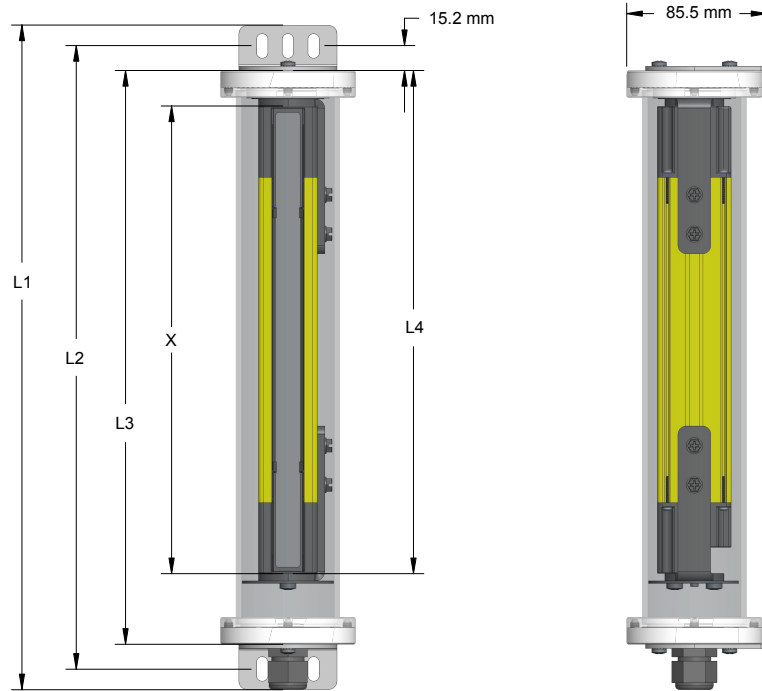

Included with each EZLSA-TE Series Tubular Enclosure	Quantity
Spacer	1
Top end cap	1
Bottom end cap	1
Polycarbonate tube	1
O-ring (#142)	2
Mounting bracket	2
M5 × 6 mm screw	2
M5 × 14 mm screw	2
M5 internal tooth lockwasher	2
#6-32 screw	8
#6 Split-ring lockwasher	8
#10-32 screw	4
#10 External tooth lockwasher	4

All measurements are listed in millimeters (inches), unless noted otherwise.

Enclosure Model	L1	L2	L3	L4	X
EZLSA-TE-280	398 mm (15.7 in)	373 mm (14.7 in)	343 mm (13.5 in)	307 mm (12.1 in)	285 mm (11.2 in)
EZLSA-TE-350	475 mm (18.7 in)	450 mm (17.7 in)	419 mm (16.5 in)	377 mm (14.8 in)	355 mm (14.0 in)
EZLSA-TE-420	538 mm (21.2 in)	513 mm (20.2 in)	483 mm (19.0 in)	446 mm (17.6 in)	425 mm (16.7 in)
EZLSA-TE-490	614 mm (24.2 in)	589 mm (23.2 in)	559 mm (22.0 in)	516 mm (20.3 in)	495 mm (19.5 in)
EZLSA-TE-560	678 mm (26.7 in)	653 mm (25.7 in)	622 mm (24.5 in)	586 mm (23.1 in)	564 mm (22.2 in)
EZLSA-TE-630	754 mm (29.7 in)	729 mm (28.7 in)	699 mm (27.5 in)	656 mm (25.8 in)	634 mm (25.0 in)
EZLSA-TE-700	817 mm (32.2 in)	792 mm (31.2 in)	762 mm (30.0 in)	726 mm (28.6 in)	704 mm (27.7 in)
EZLSA-TE-770	894 mm (35.2 in)	869 mm (34.2 in)	838 mm (33.0 in)	796 mm (31.3 in)	774 mm (30.5 in)
EZLSA-TE-840	957 mm (37.7 in)	932 mm (36.7 in)	902 mm (35.5 in)	865 mm (34.1 in)	844 mm (33.2 in)
EZLSA-TE-910	1033 mm (40.7 in)	1008 mm (39.7 in)	978 mm (38.5 in)	935 mm (36.8 in)	914 mm (36.0 in)
EZLSA-TE-980	1097 mm (43.2 in)	1072 mm (42.2 in)	1041 mm (41.0 in)	1005 mm (39.6 in)	983 mm (38.7 in)
EZLSA-TE-1050	1173 mm (46.2 in)	1148 mm (45.2 in)	1118 mm (44.0 in)	1075 mm (42.3 in)	1053 mm (41.5 in)
EZLSA-TE-1120	1237 mm (48.7 in)	1212 mm (47.7 in)	1181 mm (46.5 in)	1145 mm (45.1 in)	1123 mm (44.2 in)
EZLSA-TE-1190	1313 mm (51.7 in)	1288 mm (50.7 in)	1257 mm (49.5 in)	1215 mm (47.8 in)	1193 mm (47.0 in)
EZLSA-TE-1260	1376 mm (54.2 in)	1351 mm (53.2 in)	1321 mm (52.0 in)	1284 mm (50.6 in)	1263 mm (49.7 in)
EZLSA-TE-1330	1452 mm (57.2 in)	1427 mm (56.2 in)	1397 mm (55.0 in)	1354 mm (53.3 in)	1333 mm (52.5 in)
EZLSA-TE-1400	1516 mm (59.7 in)	1491 mm (58.7 in)	1461 mm (57.5 in)	1424 mm (56.0 in)	1402 mm (55.2 in)
EZLSA-TE-1470	1592 mm (62.7 in)	1567 mm (61.7 in)	1537 mm (60.5 in)	1494 mm (58.8 in)	1472 mm (58.0 in)
EZLSA-TE-1540	1656 mm (65.2 in)	1631 mm (64.2 in)	1600 mm (63.0 in)	1564 mm (61.6 in)	1542 mm (60.7 in)
EZLSA-TE-1610	1732 mm (68.2 in)	1707 mm (67.2 in)	1676 mm (66.0 in)	1634 mm (64.3 in)	1612 mm (63.5 in)
EZLSA-TE-1680	1795 mm (70.7 in)	1770 mm (69.7 in)	1740 mm (68.5 in)	1703 mm (67.1 in)	1682 mm (66.2 in)
EZLSA-TE-1750	1872 mm (73.7 in)	1847 mm (72.7 in)	1816 mm (71.5 in)	1773 mm (69.8 in)	1752 mm (69.0 in)
EZLSA-TE-1820	1935 mm (76.2 in)	1910 mm (75.2 in)	1880 mm (74.0 in)	1843 mm (72.5 in)	1821 mm (71.7 in)

## Banner Engineering Corp. Limited Warranty

---

Banner Engineering Corp. warrants its products to be free from defects in material and workmanship for one year following the date of shipment. Banner Engineering Corp. will repair or replace, free of charge, any product of its manufacture which, at the time it is returned to the factory, is found to have been defective during the warranty period. This warranty does not cover damage or liability for misuse, abuse, or the improper application or installation of the Banner product.

THIS LIMITED WARRANTY IS EXCLUSIVE AND IN LIEU OF ALL OTHER WARRANTIES WHETHER EXPRESS OR IMPLIED (INCLUDING, WITHOUT LIMITATION, ANY WARRANTY OF MERCHANTABILITY OR FITNESS FOR A PARTICULAR PURPOSE), AND WHETHER ARISING UNDER COURSE OF PERFORMANCE, COURSE OF DEALING OR TRADE USAGE.

This Warranty is exclusive and limited to repair or, at the discretion of Banner Engineering Corp., replacement. IN NO EVENT SHALL BANNER ENGINEERING CORP. BE LIABLE TO BUYER OR ANY OTHER PERSON OR ENTITY FOR ANY EXTRA COSTS, EXPENSES, LOSSES, LOSS OF PROFITS, OR ANY INCIDENTAL, CONSEQUENTIAL OR SPECIAL DAMAGES RESULTING FROM ANY PRODUCT DEFECT OR FROM THE USE OR INABILITY TO USE THE PRODUCT, WHETHER ARISING IN CONTRACT OR WARRANTY, STATUTE, TORT, STRICT LIABILITY, NEGLIGENCE, OR OTHERWISE.

Banner Engineering Corp. reserves the right to change, modify or improve the design of the product without assuming any obligations or liabilities relating to any product previously manufactured by Banner Engineering Corp.