

## Data sheet | Item number: 280-916

2-conductor carrier terminal block; for DIN-rail 35 x 15 and 35 x 7.5; 2.5 mm<sup>2</sup>; CAGE CLAMP®; 2,50 mm<sup>2</sup>; gray

[www.wago.com/280-916](http://www.wago.com/280-916)

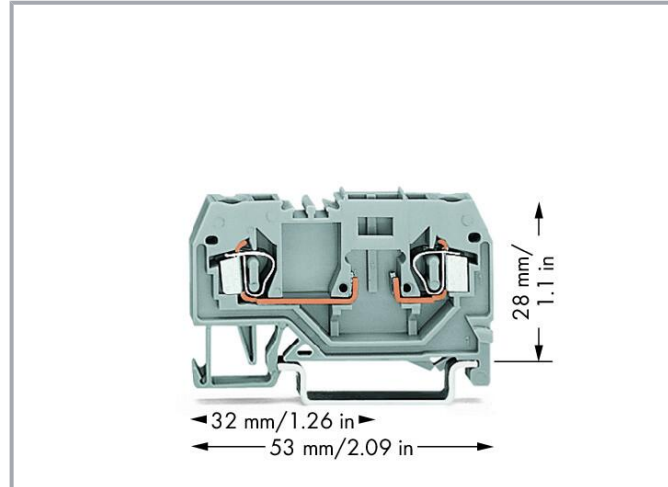
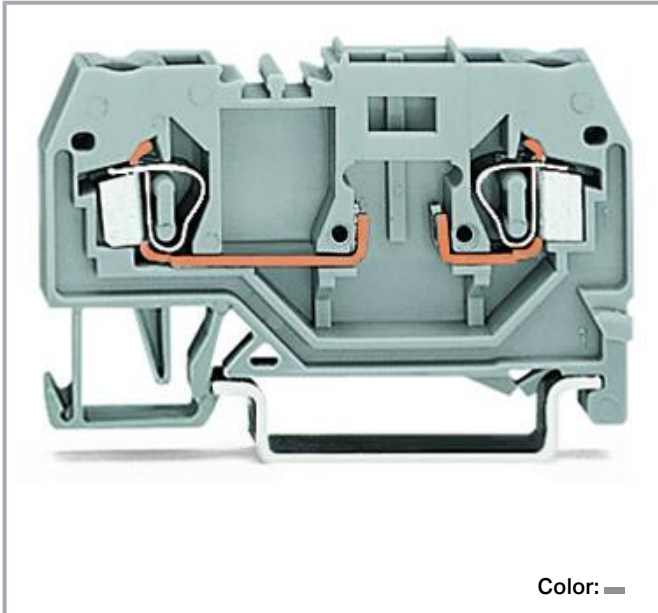

## Data

### Electrical data

### Ratings per IEC/EN

Ratings per	IEC/EN 60947-7-1
Nominal voltage (III/3)	400 V
Rated impulse voltage (III/3)	6 kV
Rated current	10 A
Legend (ratings)	(III / 3) ≙ Overvoltage category III / Pollution degree 3

### Power loss

Power loss, per pole (potential)	0.133 W
Rated current $I_N$ for specified power loss	10 A
Resistance value for specified, current-dependent power loss	0.001 $\Omega$

Subject to changes. Please also observe the further product documentation!

WAGO GmbH & Co. KG  
Hansastr. 27  
32423 Minden  
Phone: +49571 887-0 | Fax: +49571 887-169  
Email: [info.de@wago.com](mailto:info.de@wago.com) | Web: [www.wago.com](http://www.wago.com)

Do you have any questions about our products?  
We are always happy to take your call at +49 (571) 887-44222.



## Connection data

Connection points	2
Total number of potentials	2
Number of levels	1

## Connection 1

Connection technology	CAGE CLAMP®
Actuation type	Operating tool
Connectable conductor materials	Copper Aluminum

Connectable conductor materials (note)	<p><b>Terminating Aluminum Conductors</b> WAGO spring clamp terminal blocks are suitable for solid aluminum conductors up to 4 mm<sup>2</sup>/12 AWG if WAGO "Alu-Plus" Contact Paste 249-130 is used for termination.</p>
--	--

"Alu-Plus" Contact Paste Advantages:

- Automatically destroys the oxide film during clamping.
- Prevents fresh oxidation at the clamping point.
- Prevents electrolytic corrosion between aluminum and copper conductors (in the same terminal block).
- Provides long-term protection against corrosion.

Using terminal blocks with CAGE CLAMP® Spring Pressure Connection Technology, **aluminum conductors must first be cleaned with a blade** and then immediately be inserted into the clamping units filled with "Alu-Plus" Contact Paste.

It is also possible to apply WAGO "Alu-Plus" **additionally** on the whole surface of the aluminum conductor before termination.

Please note that the nominal currents must be adapted to the reduced conductivity of the aluminum conductors::

2.5 mm<sup>2</sup> = 16 A

4 mm<sup>2</sup> = 22 A

Solid conductor	0.08 ... 2.5 mm <sup>2</sup> / 28 ... 12 AWG
Fine-stranded conductor	0.08 ... 2.5 mm <sup>2</sup> / 28 ... 12 AWG
Note (conductor cross-section)	12 AWG: THHN, THWN
Strip length	8 ... 9 mm / 0.31 ... 0.35 inches

Subject to changes. Please also observe the further product documentation!

WAGO GmbH & Co. KG  
Hansastr. 27  
32423 Minden  
Phone: +49571 887-0 | Fax: +49571 887-169  
Email: [info.de@wago.com](mailto:info.de@wago.com) | Web: [www.wago.com](http://www.wago.com)

Do you have any questions about our products?  
We are always happy to take your call at +49 (571) 887-44222.



Wiring direction

Front-entry wiring

## Physical data

Width	5 mm / 0.197 inches
Height	53 mm / 2.087 inches
Depth from upper-edge of DIN-rail	28 mm / 1.102 inches

## Mechanical Data

Design	horizontal type
Mounting type	DIN-35 rail
Marking level	Center marking

## Material Data

Note (material data)

Information on material specifications can be found here

Color	gray
Material group	I
Insulation material	Polyamide (PA66)
Flammability class per UL94	V0
Fire load	0.22 MJ
Weight	5.6 g

## Environmental requirements

Processing temperature	-35 ... +85 °C
Continuous operating temperature	-60 ... +105 °C

## Commercial data

Product Group	1 (Rail Mounted Terminal Blocks)
eCl@ss 10.0	27-14-11-20
eCl@ss 9.0	27-14-11-20
ETIM 8.0	EC000897
ETIM 7.0	EC000897
PU (SPU)	100 pcs
Packaging type	box
Country of origin	DE
GTIN	4044918635981

Subject to changes. Please also observe the further product documentation!

WAGO GmbH &amp; Co. KG

Hansastr. 27

32423 Minden

Phone: +49571 887-0 | Fax: +49571 887-169

Email: [info.de@wago.com](mailto:info.de@wago.com) | Web: [www.wago.com](http://www.wago.com)

Do you have any questions about our products?

We are always happy to take your call at +49 (571) 887-44222.



Customs tariff number	85369010000
-----------------------	-------------

## Environmental Product Compliance



RoHS Compliance Status	Compliant, No Exemption
------------------------	-------------------------

## Approvals / Certificates

### General approvals

Logo	Approval	Additional Approval Text	Certificate name
	CCA DEKRA Certification B.V.	EN 60947	2157201.01
	CSA DEKRA Certification B.V.	C22.2	1536071
	UL Underwriters Laboratories Inc.	UL 1059	E45172

### Declarations of conformity and manufacturer's declarations

Logo	Approval	Additional Approval Text	Certificate name
	EU-Declaration of Conformity WAGO GmbH & Co. KG	-	-
	UK-Declaration of Conformity WAGO GmbH & Co. KG	-	-

### Approvals for marine applications

Logo	Approval	Additional Approval Text	Certificate name
	ABS American Bureau of Shipping	EN 60947	20- HG1941090- PDA
	BV	EN 60947	07436/F0 BV

Subject to changes. Please also observe the further product documentation!

WAGO GmbH & Co. KG  
 Hansastr. 27  
 32423 Minden  
 Phone: +49571 887-0 | Fax: +49571 887-169  
 Email: [info.de@wago.com](mailto:info.de@wago.com) | Web: [www.wago.com](http://www.wago.com)

Do you have any questions about our products?  
 We are always happy to take your call at +49 (571) 887-44222.



Bureau Veritas S.A.



**DNV GL**

Det Norske Veritas, Germanischer Lloyd

-

TAE00001V2



**LR**

Lloyds Register

EN 60947

91/20112  
(E9)

## Required accessories

### End plate

End plate



**Item no.: 280-308**

End and intermediate plate; 2.5 mm thick; gray

[www.wago.com/280-308](http://www.wago.com/280-308)



**Item no.: 280-309**

End and intermediate plate; 2.5 mm thick; orange

[www.wago.com/280-309](http://www.wago.com/280-309)

## Optional accessories

### Carrier rail

Mounting accessories



**Item no.: 210-197**

Steel carrier rail; 35 x 15 mm; 1.5 mm thick; 2 m long; slotted; similar to EN 60715; silver-colored

[www.wago.com/210-197](http://www.wago.com/210-197)



**Item no.: 210-198**

Copper carrier rail; 35 x 15 mm; 2.3 mm thick; 2 m long; unslotted; according to EN 60715; copper-colored

[www.wago.com/210-198](http://www.wago.com/210-198)



**Item no.: 210-504**

Steel carrier rail; 35 x 7.5 mm; 1 mm thick; 2 m long; slotted; galvanized; according to EN 60715; silver-colored

[www.wago.com/210-504](http://www.wago.com/210-504)



**Item no.: 210-505**

Steel carrier rail; 35 x 7.5 mm; 1 mm thick; 2 m long; unslotted; galvanized; according to EN 60715; silver-colored

[www.wago.com/210-505](http://www.wago.com/210-505)



**Item no.: 210-506**

Steel carrier rail; 35 x 15 mm; 1.5 mm thick; 2 m long; unslotted; galvanized; similar to EN 60715; silver-colored

[www.wago.com/210-506](http://www.wago.com/210-506)



**Item no.: 210-508**

Steel carrier rail; 35 x 15 mm; 1.5 mm thick; 2 m long; slotted; galvanized; similar to EN 60715; silver-colored

[www.wago.com/210-508](http://www.wago.com/210-508)

Subject to changes. Please also observe the further product documentation!

WAGO GmbH & Co. KG

Hansastr. 27

32423 Minden

Phone: +49571 887-0 | Fax: +49571 887-169

Email: [info.de@wago.com](mailto:info.de@wago.com) | Web: [www.wago.com](http://www.wago.com)

Do you have any questions about our products?

We are always happy to take your call at +49 (571) 887-44222.



**Item no.: 210-113**

Steel carrier rail; 35 x 7.5 mm; 1 mm thick; 2 m long; unslotted; according to EN 60715; silver-colored

[www.wago.com/210-113](http://www.wago.com/210-113)



**Item no.: 210-118**

Steel carrier rail; 35 x 15 mm; 2.3 mm thick; 2 m long; unslotted; according to EN 60715; silver-colored

[www.wago.com/210-118](http://www.wago.com/210-118)



**Item no.: 210-112**

Steel carrier rail; 35 x 7.5 mm; 1 mm thick; 2 m long; slotted; according to EN 60715; "Hole width 25 mm; silver-colored

[www.wago.com/210-112](http://www.wago.com/210-112)



**Item no.: 210-114**

Steel carrier rail; 35 x 15 mm; 1.5 mm thick; 2 m long; unslotted; similar to EN 60715; silver-colored

[www.wago.com/210-114](http://www.wago.com/210-114)



**Item no.: 210-115**

Steel carrier rail; 35 x 7.5 mm; 1 mm thick; 2 m long; slotted; according to EN 60715; "Hole width 18 mm; silver-colored

[www.wago.com/210-115](http://www.wago.com/210-115)

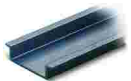

**Item no.: 210-196**

Aluminum carrier rail; 35 x 8.2 mm; 1.6 mm thick; 2 m long; unslotted; similar to EN 60715; silver-colored

[www.wago.com/210-196](http://www.wago.com/210-196)

#### Marking accessories

##### Marker



**Item no.: 2009-115/000-002**

WMB-Inline; for Smart Printer; 1500 pieces on roll; stretchable 5 - 5.2 mm; plain; snap-on type; yellow

[www.wago.com/2009-115/000-002](http://www.wago.com/2009-115/000-002)



**Item no.: 2009-115/000-007**

WMB-Inline; for Smart Printer; 1500 pieces on roll; stretchable 5 - 5.2 mm; plain; snap-on type; gray

[www.wago.com/2009-115/000-007](http://www.wago.com/2009-115/000-007)



**Item no.: 2009-115/000-017**

WMB-Inline; for Smart Printer; 1500 pieces on roll; stretchable 5 - 5.2 mm; plain; snap-on type; light green

[www.wago.com/2009-115/000-017](http://www.wago.com/2009-115/000-017)



**Item no.: 2009-115/000-023**

WMB-Inline; for Smart Printer; 1500 pieces on roll; stretchable 5 - 5.2 mm; plain; snap-on type; green

[www.wago.com/2009-115/000-023](http://www.wago.com/2009-115/000-023)



**Item no.: 2009-115/000-024**

WMB-Inline; for Smart Printer; 1500 pieces on roll; stretchable 5 - 5.2 mm; plain; snap-on type; violet

[www.wago.com/2009-115/000-024](http://www.wago.com/2009-115/000-024)



**Item no.: 2009-115**

WMB-Inline; for Smart Printer; 1500 pieces on roll; stretchable 5 - 5.2 mm; plain; snap-on type; white

[www.wago.com/2009-115](http://www.wago.com/2009-115)



**Item no.: 793-5501/000-007**

WMB marking card; as card; for terminal block width 5 - 17.5 mm; stretchable 5 - 5.2 mm; plain; snap-on type; gray

[www.wago.com/793-5501/000-007](http://www.wago.com/793-5501/000-007)

Subject to changes. Please also observe the further product documentation!

WAGO GmbH & Co. KG

Hansastr. 27

32423 Minden

Phone: +49571 887-0 | Fax: +49571 887-169

Email: [info.de@wago.com](mailto:info.de@wago.com) | Web: [www.wago.com](http://www.wago.com)

Do you have any questions about our products?

We are always happy to take your call at +49 (571) 887-44222.



**Item no.:** 793-5501/000-012

WMB marking card; as card; for terminal block width 5 - 17.5 mm; stretchable 5 - 5.2 mm; plain; snap-on type; orange

[www.wago.com/793-5501](http://www.wago.com/793-5501)

/000-012



**Item no.:** 793-5501/000-017

WMB marking card; as card; for terminal block width 5 - 17.5 mm; stretchable 5 - 5.2 mm; plain; snap-on type; light green

[www.wago.com/793-5501](http://www.wago.com/793-5501)

/000-017



**Item no.:** 793-5501/000-023

WMB marking card; as card; for terminal block width 5 - 17.5 mm; stretchable 5 - 5.2 mm; plain; snap-on type; green

[www.wago.com/793-5501](http://www.wago.com/793-5501)

/000-023



**Item no.:** 793-5501/000-024

WMB marking card; as card; for terminal block width 5 - 17.5 mm; stretchable 5 - 5.2 mm; plain; snap-on type; violet

[www.wago.com/793-5501](http://www.wago.com/793-5501)

/000-024



**Item no.:** 793-501/000-002

WMB marking card; as card; not stretchable; plain; snap-on type; yellow

[www.wago.com/793-501](http://www.wago.com/793-501)

/000-002



**Item no.:** 793-501/000-007

WMB marking card; as card; not stretchable; plain; snap-on type; gray

[www.wago.com/793-501](http://www.wago.com/793-501)

/000-007



**Item no.:** 793-501/000-017

WMB marking card; as card; not stretchable; plain; snap-on type; light green

[www.wago.com/793-501](http://www.wago.com/793-501)

/000-017



**Item no.:** 793-501/000-012

WMB marking card; as card; not stretchable; plain; snap-on type; orange

[www.wago.com/793-501](http://www.wago.com/793-501)

/000-012

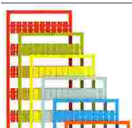

**Item no.:** 793-501/000-023

WMB marking card; as card; not stretchable; plain; snap-on type; green

[www.wago.com/793-501](http://www.wago.com/793-501)

/000-023

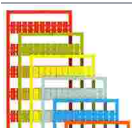

**Item no.:** 793-501/000-006

WMB marking card; as card; not stretchable; plain; snap-on type; blue

[www.wago.com/793-501](http://www.wago.com/793-501)

/000-006

Subject to changes. Please also observe the further product documentation!

WAGO GmbH & Co. KG

Hansastr. 27

32423 Minden

Phone: +49571 887-0 | Fax: +49571 887-169

Email: [info.de@wago.com](mailto:info.de@wago.com) | Web: [www.wago.com](http://www.wago.com)

Do you have any questions about our products?

We are always happy to take your call at +49 (571) 887-44222.



**Item no.: 793-501/000-005**  
WMB marking card; as card; not stretchable; plain; snap-on type; red

[www.wago.com/793-501/000-005](http://www.wago.com/793-501/000-005)



**Item no.: 793-501**  
WMB marking card; as card; not stretchable; plain; snap-on type; white

[www.wago.com/793-501](http://www.wago.com/793-501)



**Item no.: 793-501/000-024**  
WMB marking card; as card; not stretchable; plain; snap-on type; violet

[www.wago.com/793-501/000-024](http://www.wago.com/793-501/000-024)



**Item no.: 793-5501/000-005**  
WMB marking card; as card; for terminal block width 5 - 17.5 mm; stretchable 5 - 5.2 mm; plain; snap-on type; red

[www.wago.com/793-5501/000-005](http://www.wago.com/793-5501/000-005)



**Item no.: 793-5501/000-002**  
WMB marking card; as card; for terminal block width 5 - 17.5 mm; stretchable 5 - 5.2 mm; plain; snap-on type; yellow

[www.wago.com/793-5501/000-002](http://www.wago.com/793-5501/000-002)



**Item no.: 793-5501/000-006**  
WMB marking card; as card; for terminal block width 5 - 17.5 mm; stretchable 5 - 5.2 mm; plain; snap-on type; blue

[www.wago.com/793-5501/000-006](http://www.wago.com/793-5501/000-006)



**Item no.: 793-5501**  
WMB marking card; as card; for terminal block width 5 - 17.5 mm; stretchable 5 - 5.2 mm; plain; snap-on type; white

[www.wago.com/793-5501](http://www.wago.com/793-5501)



**Item no.: 2009-115/000-012**  
WMB-Inline; for Smart Printer; 1500 pieces on roll; stretchable 5 - 5.2 mm; plain; snap-on type; orange

[www.wago.com/2009-115/000-012](http://www.wago.com/2009-115/000-012)



**Item no.: 2009-115/000-006**  
WMB-Inline; for Smart Printer; 1500 pieces on roll; stretchable 5 - 5.2 mm; plain; snap-on type; blue

[www.wago.com/2009-115/000-006](http://www.wago.com/2009-115/000-006)

### Insulation stop

Insulation stop



**Item no.: 280-472**  
Insulation stop; 0.75 - 1 mm<sup>2</sup>; 5 pieces/strip; black

[www.wago.com/280-472](http://www.wago.com/280-472)



**Item no.: 280-470**  
Insulation stop; 0.08 - 0.2 mm<sup>2</sup> "s" (0.14 mm<sup>2</sup> "f-st"); 5 pieces/strip; white

[www.wago.com/280-470](http://www.wago.com/280-470)



**Item no.: 280-471**  
Insulation stop; 0.25 - 0.5 mm<sup>2</sup>; 5 pieces/strip; light gray



[www.wago.com/280-471](http://www.wago.com/280-471)

### Plugs



Subject to changes. Please also observe the further product documentation!









## Component module with a fuse

	<b>Item no.: 286-890</b> Component module with fuse; for (5 x 20) mm microfuse; Nominal voltage: 24 VAC/DC; gray	<a href="http://www.wago.com/286-890">www.wago.com/286-890</a>
	<b>Item no.: 286-891</b> Component module with fuse; for (5 x 20) mm microfuse; Nominal voltage: 230 VAC/DC; gray	<a href="http://www.wago.com/286-891">www.wago.com/286-891</a>



## Neon indicator module

	<b>Item no.: 280-801/281-417</b> Component plug; for carrier terminal blocks; 2-pole; 5 mm wide; gray	<a href="http://www.wago.com/280-801/281-417">www.wago.com/280-801/281-417</a>
	<b>Item no.: 280-801/281-418</b> Component plug; for carrier terminal blocks; 2-pole; 5 mm wide; gray	<a href="http://www.wago.com/280-801/281-418">www.wago.com/280-801/281-418</a>

## Solid-state relay module













	<b>Item no.: 286-721</b> Optocoupler module; Nominal input voltage: 24 VDC; Output voltage range: 15 ... 30 VDC; Limiting continuous current: 5 A; 3-wire connection/low-side switching; Red status indicator; Module width: 15 mm; gray	<a href="http://www.wago.com/286-721">www.wago.com/286-721</a>
	<b>Item no.: 286-723</b> Optocoupler module; Nominal input voltage: 24 VDC; Output voltage range: 15 ... 30 VDC; Limiting continuous current: 4 A; 3-wire connection/high-side switching; Red status indicator; Module width: 15 mm; gray	<a href="http://www.wago.com/286-723">www.wago.com/286-723</a>
	<b>Item no.: 286-752</b> Optocoupler module; Nominal input voltage: 24 VDC; Output voltage range: 20 ... 30 VDC; Limiting continuous current: 0.5 A; 3-wire connection/high-side switching; Frequency: 25 kHz; Red status indicator; Module width: 15 mm; gray	<a href="http://www.wago.com/286-752">www.wago.com/286-752</a>
	<b>Item no.: 286-752/002-000</b> Optocoupler module; Red status indicator; gray	<a href="http://www.wago.com/286-752/002-000">www.wago.com/286-752/002-000</a>
	<b>Item no.: 286-792</b> Optocoupler module; Red status indicator; gray	<a href="http://www.wago.com/286-792">www.wago.com/286-792</a>
	<b>Item no.: 286-794</b> Optocoupler module; Nominal input voltage: 24 VDC; Red status indicator; gray	<a href="http://www.wago.com/286-794">www.wago.com/286-794</a>
	<b>Item no.: 286-791</b> Optocoupler module; Nominal input voltage: 24 VDC; Output voltage range: 20 ... 60 VDC; Limiting continuous current: 0.1 A; 2-wire connection; Frequency: 3 kHz; Red status indicator; Module width: 10 mm; gray	<a href="http://www.wago.com/286-791">www.wago.com/286-791</a>

## Component module with diode

	<b>Item no.: 286-805</b> Component module with diode; with 5 pcs; Diode 1N4007; with common anode; gray	<a href="http://www.wago.com/286-805">www.wago.com/286-805</a>
	<b>Item no.: 286-807</b> Component module with diode; with 7 pcs; Diode 1N4007; with common anode; gray	<a href="http://www.wago.com/286-807">www.wago.com/286-807</a>



Subject to changes. Please also observe the further product documentation!

	<b>Item no.: 286-809</b> Component module with diode; with 9 pcs; Diode 1N4007; with common anode; gray	<a href="http://www.wago.com/286-809">www.wago.com/286-809</a>
Timer relay module		
	<b>Item no.: 286-604/004-000</b> Timer relay module; Nominal input voltage: 24 VDC; Limiting continuous current: 6 A; On-delay: 10 ... 100 s; Red status indicator; Module width: 20 mm; gray	<a href="http://www.wago.com/286-604/004-000">www.wago.com/286-604/004-000</a>
	<b>Item no.: 286-640/004-000</b> Timer relay module; Nominal input voltage: 24 VDC; Limiting continuous current: 5 A; Railway; Multifunction; Red status indicator; Module width: 20 mm; gray	<a href="http://www.wago.com/286-640/004-000">www.wago.com/286-640/004-000</a>
	<b>Item no.: 286-640</b> Timer relay module; Nominal input voltage: 24 VDC; Limiting continuous current: 6 A; Railway; Multifunction/Multitime; Yellow status indicator; Module width: 6 mm; gray	<a href="http://www.wago.com/286-640">www.wago.com/286-640</a>
LED plug		
	<b>Item no.: 280-801/281-413</b> Component plug; for carrier terminal blocks; 2-pole; LED (red); 24 VDC; 5 mm wide; gray	<a href="http://www.wago.com/280-801/281-413">www.wago.com/280-801/281-413</a>
	<b>Item no.: 280-801/281-414</b> Component plug; for carrier terminal blocks; 2-pole; LED (red); 48 VDC; 5 mm wide; gray	<a href="http://www.wago.com/280-801/281-414">www.wago.com/280-801/281-414</a>
	<b>Item no.: 280-801/281-415</b> Component plug; for carrier terminal blocks; 2-pole; LED (red); 5 mm wide; gray	<a href="http://www.wago.com/280-801/281-415">www.wago.com/280-801/281-415</a>
	<b>Item no.: 280-801/281-416</b> Component plug; for carrier terminal blocks; 2-pole; LED (red); 5 mm wide; gray	<a href="http://www.wago.com/280-801/281-416">www.wago.com/280-801/281-416</a>
Bridge rectifier module		
	<b>Item no.: 286-830</b> Bridge rectifier module; Input voltage: 24 VAC; with varistor protective circuit; gray	<a href="http://www.wago.com/286-830">www.wago.com/286-830</a>
Current flow monitoring module		
	<b>Item no.: 286-664</b> Current flow monitoring module; AC currents; Monitoring range: 0.2 A – 3 A; 1 changeover contact; light gray	<a href="http://www.wago.com/286-664">www.wago.com/286-664</a>
	<b>Item no.: 286-665</b> Current flow monitoring module; AC currents; Monitoring range: 1 A – 10 A; 1 changeover contact; light gray	<a href="http://www.wago.com/286-665">www.wago.com/286-665</a>
	<b>Item no.: 286-662</b> Current flow monitoring module; DC currents; Monitoring range: 0.4 A – 3.5 A; 1 make contact; light gray	<a href="http://www.wago.com/286-662">www.wago.com/286-662</a>
	<b>Item no.: 286-661</b> Current flow monitoring module; AC currents; light gray	<a href="http://www.wago.com/286-661">www.wago.com/286-661</a>
Switching module		
	<b>Item no.: 286-896</b>	<a href="http://www.wago.com/286-896">www.wago.com/286-896</a>

Subject to changes. Please also observe the further product documentation!

Switching module; with momentary switch; Switching voltage: 250 VAC; Switching current: 6 A; gray



**Item no.: 286-895**

Switching module; with changeover rocker switch; Switching voltage: 250 VAC; Switching current: 6 A; gray [www.wago.com/286-895](http://www.wago.com/286-895)

#### Fuse plug



**Item no.: 280-854/281-413**

Fuse plug; with soldered miniature fuse; with indicator lamp; LED (red); DC 15 - 30 V; 1 A FF; 5 mm wide; gray [www.wago.com/280-854/281-413](http://www.wago.com/280-854/281-413)



**Item no.: 280-854/281-415**

Fuse plug; with soldered miniature fuse; with indicator lamp; LED (red); AC 15 - 30 V; 1 A FF; 5 mm wide; gray [www.wago.com/280-854/281-415](http://www.wago.com/280-854/281-415)



**Item no.: 280-856/281-415**

Fuse plug; with soldered miniature fuse; with indicator lamp; LED (red); AC 15 - 30 V; 2 A FF; 5 mm wide; gray [www.wago.com/280-856/281-415](http://www.wago.com/280-856/281-415)



**Item no.: 280-856/281-414**

Fuse plug; with soldered miniature fuse; with indicator lamp; LED (red); DC 30 - 65 V; 2 A FF; 5 mm wide; gray [www.wago.com/280-856/281-414](http://www.wago.com/280-856/281-414)



**Item no.: 280-856**

Fuse plug; with soldered miniature fuse; 2 A FF; 5 mm wide; gray [www.wago.com/280-856](http://www.wago.com/280-856)



**Item no.: 280-854/281-414**

Fuse plug; with soldered miniature fuse; with indicator lamp; LED (red); DC 30 - 65 V; 1 A FF; 5 mm wide; gray [www.wago.com/280-854/281-414](http://www.wago.com/280-854/281-414)



**Item no.: 280-856/281-413**

Fuse plug; with soldered miniature fuse; with indicator lamp; LED (red); DC 15 - 30 V; 2 A FF; 5 mm wide; gray [www.wago.com/280-856/281-413](http://www.wago.com/280-856/281-413)



**Item no.: 280-850/281-414**

Fuse plug; with soldered miniature fuse; with indicator lamp; LED (red); DC 30 - 65 V; 250 mA FF; 5 mm wide; gray [www.wago.com/280-850/281-414](http://www.wago.com/280-850/281-414)



**Item no.: 280-850/281-413**

Fuse plug; with soldered miniature fuse; with indicator lamp; LED (red); DC 15 - 30 V; 250 mA FF; 5 mm wide; gray [www.wago.com/280-850/281-413](http://www.wago.com/280-850/281-413)



**Item no.: 280-850/281-415**

Fuse plug; with soldered miniature fuse; with indicator lamp; LED (red); AC 15 - 30 V; 250 mA FF; 5 mm wide; gray [www.wago.com/280-850/281-415](http://www.wago.com/280-850/281-415)



**Item no.: 280-852/281-413**

Fuse plug; with soldered miniature fuse; with indicator lamp; LED (red); DC 15 - 30 V; 500 mA FF; 5 mm wide; gray [www.wago.com/280-852/281-413](http://www.wago.com/280-852/281-413)



**Item no.: 280-852/281-414**

Fuse plug; with soldered miniature fuse; with indicator lamp; LED (red); DC 30 - 65 V; 500 mA FF; 5 mm wide; gray [www.wago.com/280-852/281-414](http://www.wago.com/280-852/281-414)

Subject to changes. Please also observe the further product documentation!

WAGO GmbH & Co. KG

Hansastr. 27















32423 Minden

Phone: +49571 887-0 | Fax: +49571 887-169

Email: [info.de@wago.com](mailto:info.de@wago.com) | Web: [www.wago.com](http://www.wago.com)

Do you have any questions about our products?

We are always happy to take your call at +49 (571) 887-44222.

	<b>Item no.: 280-852/281-415</b> Fuse plug; with soldered miniature fuse; with indicator lamp; LED (red); AC 15 - 30 V; 500 mA FF; 5 mm wide; gray	<a href="http://www.wago.com/280-852/281-415">www.wago.com/280-852/281-415</a>
	<b>Item no.: 280-854</b> Fuse plug; with soldered miniature fuse; 1 A FF; 5 mm wide; gray	<a href="http://www.wago.com/280-854">www.wago.com/280-854</a>
	<b>Item no.: 280-852</b> Fuse plug; with soldered miniature fuse; 500 mA FF; 5 mm wide; gray	<a href="http://www.wago.com/280-852">www.wago.com/280-852</a>
	<b>Item no.: 280-850</b> Fuse plug; with soldered miniature fuse; 250 mA FF; 5 mm wide; gray	<a href="http://www.wago.com/280-850">www.wago.com/280-850</a>
Diode plug		
	<b>Item no.: 280-801/281-411</b> Component plug; for carrier terminal blocks; 2-pole; with diode 1N4007; 5 mm wide; gray	<a href="http://www.wago.com/280-801/281-411">www.wago.com/280-801/281-411</a>
	<b>Item no.: 280-801/281-421</b> Component plug; for carrier terminal blocks; 2-pole; with LED and recovery diode; 5 mm wide; gray	<a href="http://www.wago.com/280-801/281-421">www.wago.com/280-801/281-421</a>
	<b>Item no.: 280-801/281-420</b> Component plug; for carrier terminal blocks; 2-pole; with LED and recovery diode; 5 mm wide; gray	<a href="http://www.wago.com/280-801/281-420">www.wago.com/280-801/281-420</a>
Component module with LED		
	<b>Item no.: 286-822</b> Component module with LED; Red LED; with common cathode	<a href="http://www.wago.com/286-822">www.wago.com/286-822</a>
AND gate module		
	<b>Item no.: 286-826</b> AND gate module with 6 inputs; light gray	<a href="http://www.wago.com/286-826">www.wago.com/286-826</a>
Relay module		
	<b>Item no.: 286-307/004-000</b> Relay module; Nominal input voltage: 110 VDC; 1 changeover contact; Limiting continuous current: 3 A; Railway; Red status indicator; Module width: 15 mm; gray	<a href="http://www.wago.com/286-307/004-000">www.wago.com/286-307/004-000</a>
	<b>Item no.: 286-328/004-000</b> Relay module; Nominal input voltage: 24 VDC; 2 make contact; Limiting continuous current: 6 A; Railway; Red status indicator; Module width: 20 mm; gray	<a href="http://www.wago.com/286-328/004-000">www.wago.com/286-328/004-000</a>
	<b>Item no.: 286-312</b> Relay module; Nominal input voltage: 24 VDC; 2 changeover contacts; Limiting continuous current: 7 A; Red status indicator; Module width: 20 mm; gray	<a href="http://www.wago.com/286-312">www.wago.com/286-312</a>
	<b>Item no.: 286-328</b> Relay module; Nominal input voltage: 24 VDC; 2 make contact; Limiting continuous current: 6 A; Red status indicator; Module width: 20 mm; gray	<a href="http://www.wago.com/286-328">www.wago.com/286-328</a>
	<b>Item no.: 286-312/004-000</b> Relay module; Nominal input voltage: 24 VDC; 2 changeover contacts; Limiting continuous current: 5 A; Railway; Red status indicator; Module width: 20 mm; gray	<a href="http://www.wago.com/286-312/004-000">www.wago.com/286-312/004-000</a>

Subject to changes. Please also observe the further product documentation!

	<b>Item no.: 286-316</b> Relay module; Nominal input voltage: 220 VDC; 2 changeover contacts; Limiting continuous current: 7 A; Red status indicator; Module width: 20 mm; gray	<a href="http://www.wago.com/286-316">www.wago.com/286-316</a>
	<b>Item no.: 286-320</b> Relay module; Nominal input voltage: 24 VDC; 1 break and 1 make contact; Limiting continuous current: 6 A; Red status indicator; Module width: 20 mm; gray	<a href="http://www.wago.com/286-320">www.wago.com/286-320</a>
	<b>Item no.: 286-336/001-000</b> Relay module; Nominal input voltage: 24 VDC; 2 break and 2 make contacts; Red status indicator; Module width: 25 mm; gray	<a href="http://www.wago.com/286-336/001-000">www.wago.com/286-336/001-000</a>
	<b>Item no.: 286-352/004-000</b> Relay module; Nominal input voltage: 24 VDC; 4 make contacts; Limiting continuous current: 5 A; Railway; Red status indicator; Module width: 25 mm; gray	<a href="http://www.wago.com/286-352/004-000">www.wago.com/286-352/004-000</a>
	<b>Item no.: 286-344/004-000</b> Relay module; Nominal input voltage: 24 VDC; 3 break contacts and 1 make contact; Railway; Red status indicator; Module width: 25 mm; gray	<a href="http://www.wago.com/286-344/004-000">www.wago.com/286-344/004-000</a>
	<b>Item no.: 286-364/004-000</b> Relay module; Nominal input voltage: 24 VDC; 1 make contact; Limiting continuous current: 3 A; Railway; Red status indicator; Module width: 10 mm; gray	<a href="http://www.wago.com/286-364/004-000">www.wago.com/286-364/004-000</a>
	<b>Item no.: 286-368/004-000</b> Relay module; Nominal input voltage: 24 VDC; 1 break contact; Limiting continuous current: 3 A; Railway; Red status indicator; Module width: 10 mm; gray	<a href="http://www.wago.com/286-368/004-000">www.wago.com/286-368/004-000</a>
	<b>Item no.: 286-364</b> Relay module; Nominal input voltage: 24 VDC; 1 make contact; Limiting continuous current: 5 A; Red status indicator; Module width: 10 mm; gray	<a href="http://www.wago.com/286-364">www.wago.com/286-364</a>
	<b>Item no.: 286-376</b> Relay module; Nominal input voltage: 24 VDC; 1 make contact; Limiting continuous current: 5 A; for switching higher DC loads; Red status indicator; Module width: 15 mm; gray	<a href="http://www.wago.com/286-376">www.wago.com/286-376</a>
	<b>Item no.: 286-368</b> Relay module; Nominal input voltage: 24 VDC; 1 break contact; Limiting continuous current: 5 A; Red status indicator; Module width: 10 mm; gray	<a href="http://www.wago.com/286-368">www.wago.com/286-368</a>
	<b>Item no.: 286-394/004-000</b> Relay module; Nominal input voltage: 24 VDC; 1 changeover contact; Limiting continuous current: 1 A; with gold contacts; Railway; Red status indicator; Module width: 15 mm; light gray	<a href="http://www.wago.com/286-394/004-000">www.wago.com/286-394/004-000</a>
	<b>Item no.: 286-380</b> Bistable relay module; Nominal input voltage: 24 VDC; 1 changeover contact; Limiting continuous current: 6 A; Red status indicator; Module width: 15 mm; gray	<a href="http://www.wago.com/286-380">www.wago.com/286-380</a>
	<b>Item no.: 286-320/004-000</b> Relay module; Nominal input voltage: 24 VDC; 1 break and 1 make contact; Railway; Red status indicator; Module width: 20 mm; gray	<a href="http://www.wago.com/286-320/004-000">www.wago.com/286-320/004-000</a>
	<b>Item no.: 286-573</b> Latching relay module; Nominal input voltage: 24 VDC; 1 changeover contact; Limiting continuous current: 6 A; Red status indicator; Module width: 15 mm	<a href="http://www.wago.com/286-573">www.wago.com/286-573</a>
	<b>Item no.: 286-304</b>	

Subject to changes. Please also observe the further product documentation!

Relay module; Nominal input voltage: 24 VDC; 1 changeover contact; Limiting continuous current: 7 A; [www.wago.com/286-304](http://www.wago.com/286-304)  
Red status indicator; Module width: 15 mm; gray

**Item no.: 286-304/004-000**

Relay module; Nominal input voltage: 24 VDC; 1 changeover contact; Limiting continuous current: 6 A; [www.wago.com/286-304/004-000](http://www.wago.com/286-304/004-000)  
Railway; Red status indicator; Module width: 15 mm; gray

**Item no.: 286-508**

Relay module; Nominal input voltage: 230 VAC; 1 changeover contact; Limiting continuous current: 7 A; [www.wago.com/286-508](http://www.wago.com/286-508)  
Red status indicator; Module width: 15 mm; gray

**Item no.: 286-507**

Relay module; Nominal input voltage: 115 VAC; 1 changeover contact; Limiting continuous current: 7 A; [www.wago.com/286-507](http://www.wago.com/286-507)  
Red status indicator; Module width: 15 mm; gray

**Item no.: 286-516**

Relay module; Nominal input voltage: 230 VAC; 2 changeover contacts; Limiting continuous current: 7 A; [www.wago.com/286-516](http://www.wago.com/286-516)  
Red status indicator; Module width: 15 mm; gray

## S0 interface power supply unit

**Item no.: 286-742**

S0 interface power supply; Input voltage: 230 VAC; S0 interface [www.wago.com/286-742](http://www.wago.com/286-742)

## Empty component plug housing

**Item no.: 280-801**

Empty component plug housing; gray [www.wago.com/280-801](http://www.wago.com/280-801)

**Item no.: 280-802**

Empty component plug housing; gray [www.wago.com/280-802](http://www.wago.com/280-802)

**Item no.: 280-804**

Empty component plug housing; 10 mm wide; Type 3; 4-pole; gray [www.wago.com/280-804](http://www.wago.com/280-804)

**Item no.: 286-112**

Empty component plug housing; Type 11; 20 mm wide; 8-pole; gray [www.wago.com/286-112](http://www.wago.com/286-112)

**Item no.: 286-113**

Empty component plug housing; Type 12; 25 mm wide; 10-pole; gray [www.wago.com/286-113](http://www.wago.com/286-113)

**Item no.: 286-110**

Empty component plug housing; Type 9; 10 mm wide; 4-pole; gray [www.wago.com/286-110](http://www.wago.com/286-110)

**Item no.: 286-111**

Empty component plug housing; Type 10; 15 mm wide; 6-pole; gray [www.wago.com/286-111](http://www.wago.com/286-111)

## Ferrule

## Ferrule

**Item no.: 216-101**

Ferrule; Sleeve for 0.5 mm<sup>2</sup> / AWG 22; uninsulated; electro-tin plated; silver-colored [www.wago.com/216-101](http://www.wago.com/216-101)

**Item no.: 216-104**

Ferrule; Sleeve for 1.5 mm<sup>2</sup> / AWG 16; uninsulated; electro-tin plated; silver-colored [www.wago.com/216-104](http://www.wago.com/216-104)

**Item no.: 216-102**

Ferrule; Sleeve for 0.75 mm<sup>2</sup> / AWG 20; uninsulated; electro-tin plated; silver-colored [www.wago.com/216-102](http://www.wago.com/216-102)

Subject to changes. Please also observe the further product documentation!

WAGO GmbH & Co. KG

Hansastr. 27

















32423 Minden

Phone: +49571 887-0 | Fax: +49571 887-169

Email: [info.de@wago.com](mailto:info.de@wago.com) | Web: [www.wago.com](http://www.wago.com)

Do you have any questions about our products?

We are always happy to take your call at +49 (571) 887-44222.

	<b>Item no.: 216-103</b> Ferrule; Sleeve for 1 mm <sup>2</sup> / AWG 18; uninsulated; electro-tin plated	<a href="http://www.wago.com/216-103">www.wago.com/216-103</a>
	<b>Item no.: 216-203</b> Ferrule; Sleeve for 1 mm <sup>2</sup> / AWG 18; insulated; electro-tin plated; red	<a href="http://www.wago.com/216-203">www.wago.com/216-203</a>
	<b>Item no.: 216-202</b> Ferrule; Sleeve for 0.75 mm <sup>2</sup> / 18 AWG; insulated; electro-tin plated; gray	<a href="http://www.wago.com/216-202">www.wago.com/216-202</a>
	<b>Item no.: 216-204</b> Ferrule; Sleeve for 1.5 mm <sup>2</sup> / AWG 16; insulated; electro-tin plated; black	<a href="http://www.wago.com/216-204">www.wago.com/216-204</a>
	<b>Item no.: 216-201</b> Ferrule; Sleeve for 0.5 mm <sup>2</sup> / 20 AWG; insulated; electro-tin plated; white	<a href="http://www.wago.com/216-201">www.wago.com/216-201</a>
	<b>Item no.: 216-301</b> Ferrule; Sleeve for 0.25 mm <sup>2</sup> / AWG 24; insulated; electro-tin plated; yellow	<a href="http://www.wago.com/216-301">www.wago.com/216-301</a>
	<b>Item no.: 216-302</b> Ferrule; Sleeve for 0.34 mm <sup>2</sup> / 22 AWG; insulated; electro-tin plated; light turquoise	<a href="http://www.wago.com/216-302">www.wago.com/216-302</a>
<b>Jumpers</b>		
Jumper		
	<b>Item no.: 210-123</b> Wire commoning chain; insulated; blue	<a href="http://www.wago.com/210-123">www.wago.com/210-123</a>
	<b>Item no.: 210-103</b> Wire commoning chain; insulated; black	<a href="http://www.wago.com/210-103">www.wago.com/210-103</a>
	<b>Item no.: 280-492</b> Jumper; 2-way; insulated; gray	<a href="http://www.wago.com/280-492">www.wago.com/280-492</a>
	<b>Item no.: 280-482</b> Jumper; 2-way; insulated; gray	<a href="http://www.wago.com/280-482">www.wago.com/280-482</a>
	<b>Item no.: 280-484</b> Jumper; 4-way; insulated; gray	<a href="http://www.wago.com/280-484">www.wago.com/280-484</a>
	<b>Item no.: 280-490</b> Jumper; 10-way; insulated; gray	<a href="http://www.wago.com/280-490">www.wago.com/280-490</a>
	<b>Item no.: 280-485</b> Jumper; 5-way; insulated; gray	<a href="http://www.wago.com/280-485">www.wago.com/280-485</a>
	<b>Item no.: 280-483</b> Jumper; 3-way; insulated; gray	<a href="http://www.wago.com/280-483">www.wago.com/280-483</a>
	<b>Item no.: 709-110</b> Wire commoning chain; 2.5 mm <sup>2</sup> ; insulated; black	<a href="http://www.wago.com/709-110">www.wago.com/709-110</a>

Subject to changes. Please also observe the further product documentation!



**Item no.: 709-112**  
Wire commoning chain; 2.5 mm²; insulated; black

[www.wago.com/709-112](http://www.wago.com/709-112)



**Item no.: 709-111**  
Wire commoning chain; 2.5 mm²; insulated; black

[www.wago.com/709-111](http://www.wago.com/709-111)

## Tool

### Operating tool



**Item no.: 210-657**  
Operating tool; Blade: 3.5 x 0.5 mm; with a partially insulated shaft; short; multicoloured

[www.wago.com/210-657](http://www.wago.com/210-657)



**Item no.: 210-658**  
Operating tool; Blade: 3.5 x 0.5 mm; with a partially insulated shaft; angled; short; multicoloured

[www.wago.com/210-658](http://www.wago.com/210-658)



**Item no.: 210-720**  
Operating tool; Blade: 3.5 x 0.5 mm; with a partially insulated shaft; multicoloured

[www.wago.com/210-720](http://www.wago.com/210-720)

## Mounting

### Mounting accessories



**Item no.: 209-106**  
Mounting carrier; for isolated mounting on DIN 35 rails; gray

[www.wago.com/209-106](http://www.wago.com/209-106)



**Item no.: 249-116**  
Screwless end stop; 6 mm wide; for DIN-rail 35 x 15 and 35 x 7.5; gray

[www.wago.com/249-116](http://www.wago.com/249-116)

## Protective warning marker

### Cover



**Item no.: 280-415**  
Protective warning marker; for 5 terminal blocks; with high-voltage symbol, black; yellow

[www.wago.com/280-415](http://www.wago.com/280-415)

## Downloads

### Documentation

#### Bid Text

280-916 X81 - Datei	2019 Feb 19	xml 3.3 kB	Download
280-916 doc - Datei	2017 Apr 28	doc 25.1 kB	Download

### Additional Information

Subject to changes. Please also observe the further product documentation!

WAGO GmbH & Co. KG  
Hansastr. 27  
32423 Minden  
Phone: +49571 887-0 | Fax: +49571 887-169  
Email: [info.de@wago.com](mailto:info.de@wago.com) | Web: [www.wago.com](http://www.wago.com)

Do you have any questions about our products?  
We are always happy to take your call at +49 (571) 887-44222.





Technical Section  
Technical explanations

pdf  
2.2 MB      Download

## CAD/CAE-Data

### CAD data

2D/3D Models 280-916      URL      Download

### CAE data

EPLAN Data Portal 280-916      URL      Download

WSCAD Universe 280-916      URL      Download

ZUKEN Portal 280-916      URL      Download

## Environmental Product Compliance

### Compliance Search

Environmental Product Compliance 280-916      URL      Download

2-conductor carrier terminal block; for DIN-rail 35 x 15 and 35 x 7.5; 2.5 mm<sup>2</sup>; CAGE CLAMP®; 2,50 mm<sup>2</sup>; gray

## Installation Notes

Subject to changes. Please also observe the further product documentation!