

**PLEASE CHECK WWW.MOLEX.COM FOR LATEST PART INFORMATION**

**Part Number:** [52892-1595](#)  
**Status:** **Active**  
**Description:** 0.50mm Pitch Easy-On™ Type FFC/FPC Connector, Right Angle, SMT, ZIF, Bottom Contact Style, Cable Retention Guide, 15 Circuits, Lead-Free

**Documents:**

[3D Model](#) [Packaging Specification SPK-52892-001 \(PDF\)](#)  
[Drawing \(PDF\)](#) [RoHS Certificate of Compliance \(PDF\)](#)  
[Product Specification PS-52892-038 \(PDF\)](#)

**General**

Product Family FFC/FPC Connectors  
 Series [52892](#)  
 Comments Hinge, Cable Guide  
 Product Name Easy-On™  
 UPC 822348116454

**Physical**

Circuits (Loaded) 15  
 Color - Resin Natural  
 Contact Position Bottom  
 Durability (mating cycles max) 20  
 Entry Angle 90° Angle  
 Mated Height 2.00mm  
 Material - Metal Phosphor Bronze  
 Material - Plating Mating Tin-Bismuth  
 Material - Plating Termination Tin-Bismuth  
 Material - Resin High Temperature Thermoplastic  
 Net Weight 180.060/mg  
 Number of Rows 1  
 Orientation Right Angle  
 PCB Locator No  
 PCB Retention Yes  
 Packaging Type Embossed Tape on Reel  
 Pitch - Mating Interface 0.50mm  
 Plating min - Mating 1.016µm  
 Plating min - Termination 1.016µm  
 Polarized to PCB No  
 Stackable No  
 Surface Mount Compatible (SMC) N/A  
 Temperature Range - Operating -25°C to +85°C  
 Termination Interface: Style Surface Mount  
 Wire/Cable Type FFC/FPC

**Electrical**

Current - Maximum per Contact 0.5A  
 Voltage - Maximum 50V

**Material Info**

**Reference - Drawing Numbers**

Packaging Specification SPK-52892-001  
 Product Specification PS-52892-038, RPS-52892-036, RPS-52892-039, RPS-52892-045, RPS-52892-049, RPS-52892-052  
 Sales Drawing SD-52892-040, SD-52892-041

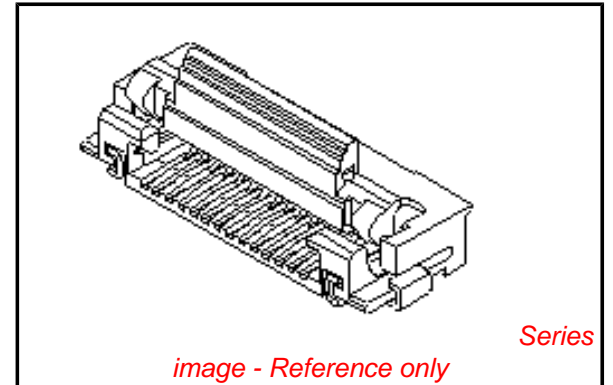

*image - Reference only*

**EU RoHS**

**ELV and RoHS  
 Compliant**  
**REACH SVHC  
 Contains SVHC: No  
 Low-Halogen Status  
 Not Low-Halogen**

**China RoHS**



**Need more information on product  
 environmental compliance?**

Email [productcompliance@molex.com](mailto:productcompliance@molex.com)  
 For a multiple part number RoHS Certificate of Compliance, [click here](#)

Please visit the [Contact Us](#) section for any non-product compliance questions.

**Search Parts in this Series**

[52892Series](#)

This document was generated on 03/08/2013

**PLEASE CHECK [WWW.MOLEX.COM](http://WWW.MOLEX.COM) FOR LATEST PART INFORMATION**