

# SR-1000-SFP-XT DIN Rail Media Converter

---

 [perle.com/products/media-converters/sr-1000-sfp-xt-din-rail-copper-fiber-converter.shtml](http://perle.com/products/media-converters/sr-1000-sfp-xt-din-rail-copper-fiber-converter.shtml)

## Industrial Gigabit Copper to Fiber Converter

---

- 1000Base-T to 1000Base-X Fiber Media Converter
- Link copper to multimode or single mode fiber
- Empty slot for Cisco and other industry standard SFPs
- -40°C to +75°C (-40°F to +167°F) extended operating temperature
- Advanced Features: Link Pass-Through, Far-End Fault, Auto-MDIX
- Triple Power Input: Dual Terminal block power connector & T-Bus



The Perle **SR-1000-SFP-XT DIN Rail Media Converter** transparently connects UTP copper to fiber in industrial grade operating temperatures **-40°F to +167°F (-40°C to +75°C)**. Equipment found in traffic management, oil and gas pipelines, weather **tracking, industrial and outdoor applications** must function in temperatures that cannot be supported by a commercial based media converter. This Gigabit Media Converter is ideal for use with industrial devices subjected to harsh environments and severe temperatures such as security cameras, wireless access points, alarms, traffic controllers, sensors and tracking devices.

- Extend the data transmission distance of IP-based devices by connecting their 1000Base-T Copper interface to fiber.
- Extend the distance of an existing industrial network by linking CAT5/6/7 cabling to multimode or single mode fiber.
- Protect Ethernet data from EMI noise and interference by inter-connecting your copper-Ethernet devices over fiber in industrial plants.

The pluggable fiber optics port allows for flexible network configurations using SFP transceivers supplied by Perle, Cisco or other manufacturers of MSA compliant SFPs.

Network Administrators can "see-everything" with Perle's advanced features such as Auto-Negotiation, Auto-MDIX, Link Pass-Through, Fiber Fault Alert, and Loopback. This allows for more efficient troubleshooting and less on-site maintenance. These cost and time saving features, along with a lifetime warranty and free worldwide technical support, make the **SR-1000-SFP-XT Gigabit Media Converter** the smart choice for IT professionals.

## SR-1000-SFP-XT Fiber Media Converter Features: 1000Base-T to 1000Base-X

---

Fully designed to operate in extreme temperatures

Perle SR-1000-XT Industrial Media Converters only use components that are fully qualified and rated to operate in -40F to +167F.

There are other products on the market that claim to operate at -40°F to +167°F however, they use “commercial-grade” components that have not been qualified by the manufacturer (OEM) to operate at the claimed temperature ranges. When “commercial-grade” parts are exposed to extremely high or low temperatures, product failures are inevitable. For example, integrated circuits on the PCB overheat causing premature failures. Under-rated connectors do not allow for proper contact between the device and the cables. These failures eventually stop all data communications in these high and low temperature environments.

*By choosing Perle you can be confident you will not be subjected to these failures.*

---

DIN Rail Enclosure

Easily mount on a DIN rail or inside distribution boxes using native DIN Rail enclosure with grounding clip. No need for add-on brackets.

---

Auto-Negotiation

The media converter supports auto negotiation. The 1000Base-X fiber interface negotiates according to 802.3 clause 37. The 1000Base-T negotiates according to 802.3 clause 28 and 40. The 1000Base-X will link up with its partner after the highest common denominator (HCD) is reached and the copper has linked up with its partner. The 1000Base-X will continue to cycle through negotiation transmitting a remote fault of offline (provided this is enabled through the switch setting) until the copper is linked up and the HCDs match.

The media converter supports auto-negotiation of full duplex, half duplex, remote fault, full duplex pause, asymmetric pause and Auto MDI-X.

---

Auto-MDIX with Skew Correction

Auto-MDIX (automatic medium-dependant interface crossover) detects the signaling on the 1000Base-T interface to determine the type of cable connected (straight-through or crossover) and automatically configures the connection when enabled. The media converter can also correct for wires swapped within a pair.

The media converter will adjust for up to 64ns of delay skew between the 1000Base-T pairs.

---

Smart Link Pass-Through

When Smart Link Pass-Through mode is enable, the Ethernet copper port will reflect the state of the Ethernet fiber media converter port. This feature can be used whether fiber auto-negotiation is enabled or disabled.

---

Fiber Fault Alert	With Fiber Fault Alert the state of the 1000Base-X receiver is passed to the 1000Base-X transmitter. This provides fault notification to the partner device attached to the 1000Base-X interface of the media converter. If the 1000Base-X transmitter is off, as a result of this fault, it will be turned on periodically to allow the condition to clear should the partner device on the 1000Base-X be using a similar technique. This eliminates the possibility of lockouts that occur with some media converters. Applies only when fiber auto-negotiation is disabled.
Pause (IEEE 802.3x)	Pause signaling is an IEEE feature that temporarily suspends data transmission between two devices in the event that one of the devices becomes overwhelmed. The media converter supports pause negotiation on the 1000Base-T copper connection and 1000Base-X fiber connection.
Duplex	Full and half duplex operation supported.
Jumbo Packets	Transparent to jumbo packets up to 10KB.
VLAN	Transparent to VLAN tagged packets.
Remote LoopBack	Capable of performing a loopback on the 1000Base-X fiber interface.

## Hardware Specifications: SR-1000-SFP-XT Media Converters

### Power

Input Supply Voltage	Triple voltage 12 / 24 / 48 VDC (9.6 – 60 VDC) input supporting: a) 2 x Terminal Block power input and b) 1 x T-Bus power input
Current	0.09 A (@ 24VDC)
Power Consumption	2.16 watts (@ 24VDC)
Power Connector	Dual input Terminal Block and/or T-Bus

### Indicators

Power / TST	This green LED is turned on when power is applied to the media converter. Otherwise it is off. The LED will blink fast/slow when in Loopback test mode or hardware error.
-------------	---

---

Fiber link on / Receive activity (LKF)	On: Fiber link present. Blinking slowly: Fiber link disabled because of copper link loss. Blinking quickly: Fiber link present and receiving data. Off: No fiber link present
--	---

---

Copper link on / Receive activity (LKC)	On: Fiber link present. Blinking slowly: Fiber link disabled because of copper link loss. Blinking quickly: Fiber link present and receiving data. Off: No fiber link present
---	---

---

### Switches - accessible by sliding the chassis open

---



---

Auto-Negotiation	Auto (Default-Up): In this mode of operation the media converter will negotiate Ethernet parameters on both the copper and the fiber connection. This will ensure the most optimal connection parameters will be in effect. If connecting to another Perle Gigabit Media Converter, this parameter should be set to Auto.
------------------	---

Off: The fiber Negotiation should only be turned off, if the fiber link partner does not support fiber link negotiations

---

Smart Link Pass-Through	Standard Mode (Default-Up): In this mode, if Fiber Negotiation is set to OFF, the links on the fiber and copper sides can be brought up and down independently of each other. A loss of link on either the fiber link or copper link can take place without affecting the other connection. However, if the Fiber Negotiation (switch 2) is set to Auto, then a loss of link on the copper side will result in a loss of link on the fiber side but not vice versa.
-------------------------	---

Smart Link Pass-Through (Down): In this mode, the link state on one connection is directly reflected through the media converter to the other connection. If link is lost on one of the connections, then the other link will be brought down by the media converter.

---

Pause	Enabled (Default-Up): In this mode, when Fiber Negotiation has been turned off, the media converter will use this setting for its Ethernet parameter negotiation on the copper connection. With this Pause switch in the Enabled position, the media converter will advertise support for Symmetrical and Asymmetrical Pause.
-------	---

Disabled: The media converter will not advertise support for the Pause feature.

---

---

Loopback	<p>Disabled (Default-Up): The loopback feature is disabled. This is the normal position for regular operation. The switch must be set to this position for data to pass through the media converter.</p> <p>Enabled: This is a test mode. All data received on the receive (RX) fiber connection is looped back to the transmit (TX) fiber connection. The state of the copper is not relevant and no data or link status is passed through to the copper side.</p>
----------	---

---

Fiber Fault Alert (FFA)	<p>Enabled (Default-Up): In this mode, when Fiber negotiation is turned on, if the media converter detects a loss of fiber signal on the fiber receiver it will immediately disable its fiber transmitter signal. This notifies the fiber link partner that an error condition exists on the fiber connection. If the remote media converter is set up for FFA Enabled and the local media converter is set up with Smart Link Pass-Through, a loss of fiber link on either the transmit or receive line will be passed through to the local copper connection to notify the connected device. If the media converter has been set to Smart Link Pass-Through mode, the effect will be the same as FFA since the link loss on the fiber receiver will result in bringing down the copper link, which will in turn cause the transmit fiber link to be brought down.</p> <p>Disabled: In this mode, the media converter will not monitor for fiber fault.</p>
-------------------------	--

---

Duplex Mode	<p>Auto (Default-Up): In this mode, when Fiber Negotiation has been turned off, the media converter will use this Duplex setting for its Ethernet parameter negotiation on the copper connection. In the Auto position, the media converter will advertise support for both Full and Half Duplex mode. The resultant negotiation will provide the most optimum connection.</p> <p>Half: In this mode, the media converter will force the negotiation to Half Duplex mode</p>
-------------	--

---

### Cables and Connectors

---

1000Base-T	RJ45 connector, 4 pair CAT 5 (UTP or STP) or better cable
Small Form Factor Pluggable ( SFP ) slot	<p>SFP slot models: Empty slot for 100Base-X SFP modules supplied by Perle, Cisco or other manufacturers of MSA compliant SFPs.</p> <p>Hot insertion and removable ( hot swappable ).</p>
Magnetic Isolation	1.5kv
Fiber Optic Cable	<p>Multimode: 62.5 / 125, 50/125, 85/125, 100/140 micron</p> <p>Single Mode: 9/125 micron (ITU-T 625)</p>

---

### Filtering

---

---

Filtering	1024 MAC Addresses
-----------	--------------------

---

### **Frame Specifications**

---

Buffer	1000 Kbits frame buffer memory
--------	--------------------------------

---

Size	Maximum frame size of 10,240 bytes
------	------------------------------------

---

### **Packet Transmission Characteristics**

---

Bit Error Rate (BER)	<10 <sup>-12</sup>
----------------------	--------------------

---

### **Environmental Specifications**

---

Operating Temperature	-40 C to 75 C (-40 F to 167 F)
-----------------------	--------------------------------

---

Storage Temperature	-40 C to 85 C (-40 F to 185 F)
---------------------	--------------------------------

---

Operating Humidity	5% to 90% non-condensing
--------------------	--------------------------

---

Storage Humidity	5% to 95% non-condensing
------------------	--------------------------

---

Operating Altitude	Up to 3,048 meters (10,000 feet)
--------------------	----------------------------------

---

Heat Output ( BTU/HR )	7.37
------------------------	------

---

MTBF (Hours)	696,927 (Calculation model based on MIL-HDBK-217-FN2 @ 30 °C)
--------------	---

---

Chassis	Molded plastic DIN Rail case with an IP20 ingress protection rating
---------	---

---

### **Mounting**

---

Din Rail Kit	Native
--------------	--------

---

### **Product Weight and Dimensions**

---

Weight	0.12 kg, 0.26 lbs
--------	-------------------

---

Dimensions	114 x 100 x 22.5mm, 4.5 x 3.9 x 0.88 inches
------------	---

---

### **Packaging**

---

---

Shipping Weight	0.17 kg, 0.37 lbs
-----------------	-------------------

---

Shipping Dimensions	145 x 105 x 30 mm, 5.7 x 4.1 x 1.2 inches
---------------------	---

---

### **Regulatory Approvals**

---

Emissions	FCC 47 Part 15 Class A, EN55032 (CISPR32) Class A EN55011 (CISPR11) ICES-003 EN61000-6-4 (Emissions for industrial environments) CISPR 32:2015/EN 55032:2015 (Class A) CISPR 24:2010/EN 55024:2010 EN61000-3-2
-----------	--

---

Immunity	EN55024 EN 61000-4-2 (ESD) EN 61000-4-3 (RS) EN 61000-4-4 (EFT) EN 61000-4-5 (Surge) EN 61000-4-6 (CS) EN 61000-4-8 (PFMF) EN 61000-4-11 IEC/EN 61000-6-2 (General Immunity for Industrial Environments)
----------	--

---

Electrical Safety	IEC 62368-1(ed 2) EN 62368-1:2014
-------------------	--------------------------------------

---

CE

---

Laser Safety	EN 60825-1:2007
--------------	-----------------

---

Fiber optic transmitters on this device meet Class 1 Laser safety requirements per IEC-60825 FDA/CDRH standards and comply with 21CFR1040.10 and 21CFR1040.11.

---

Environmental	Reach, RoHS and WEEE Compliant
---------------	--------------------------------

---

Other	ECCN: 5A991
-------	-------------

---

HTSUS Number: 8517.62.0020

---

Perle Limited Lifetime Warranty

---

### **Gigabit to IP Cameras**

---

---

## Connect IP Cameras to Gigabit Backbone

Extend the reach to IP cameras using industrial fiber media converters. Security cameras are typically installed in remote locations where extremely high or low temperatures are a concern -- ceilings, rooftops, light poles, along fences, pipelines and transit routes.

Stand-alone Extended Temperature Media Converters are placed at the remote end connecting cameras with copper interfaces to fiber optic cabling. The fiber can extend the distance using single mode or multimode fiber back to a control center. A media converter chassis located in the data closet at the control center accepts the fiber signal, converts it, and connects to the copper equipment at the main site.

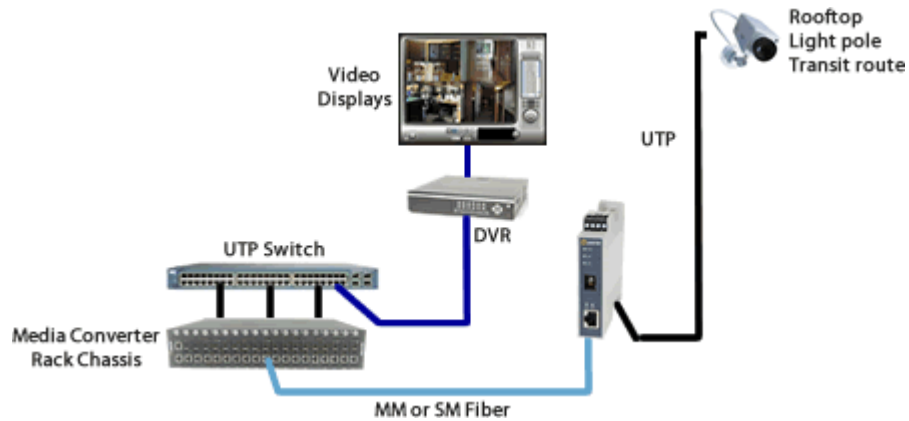

---

## Gigabit Fiber to Wireless Access Points

---



---

### Connect Wireless Access Points to Gigabit Backbone

Extend the reach to wireless access points ( AP ) using fiber media converters. When a company deploys a wireless network in their office or large warehouse, APs need to be set up throughout the facility to ensure complete coverage for reliability. The network manager will likely need to extend further than the 100 meters allowed by copper cable to reach many of the APs.

When APs are used in industrial environments where extremely high or low temperatures are a concern, Stand-alone Extended Temperature Media Converters are placed at the remote end connecting APs with copper interfaces to fiber optic cabling. The fiber can extend the distance using single mode or multimode fiber back to a control center. A media converter chassis located in the data closet at the control center accepts the fiber signal, converts it, and connects to the copper equipment at the main site.

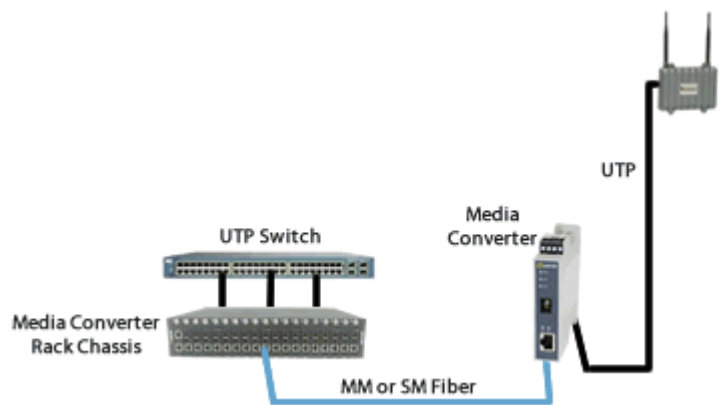

---

### Extend between two UTP Gigabit Switches

#### Extend the network distance between two twisted pair Gigabit Switches

Two Gigabit Ethernet Media Converters can extend the distance between 1000Base-T Switches across a fiber link using industry standard SFPs..

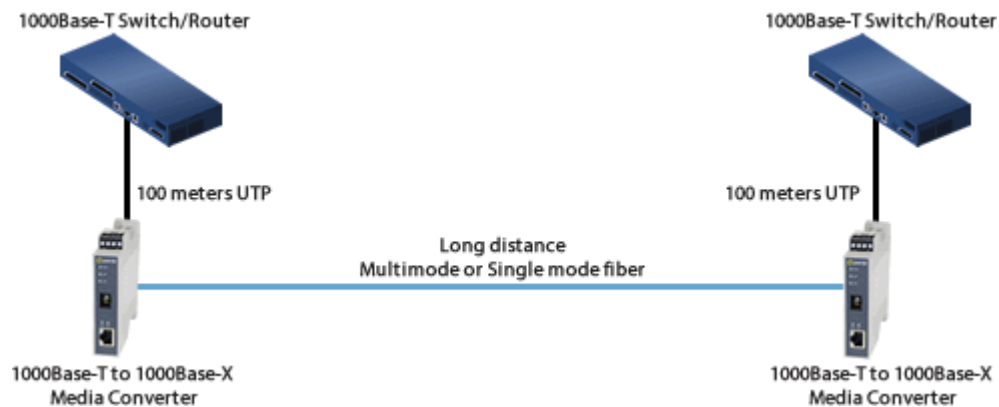

---

### Gigabit UTP Switch to Fiber Switch

---

---

### Interconnect a UTP Switch with a Fiber Switch

A media converter can interconnect a UTP copper based Switch port to a remote switch that has integrated fiber.

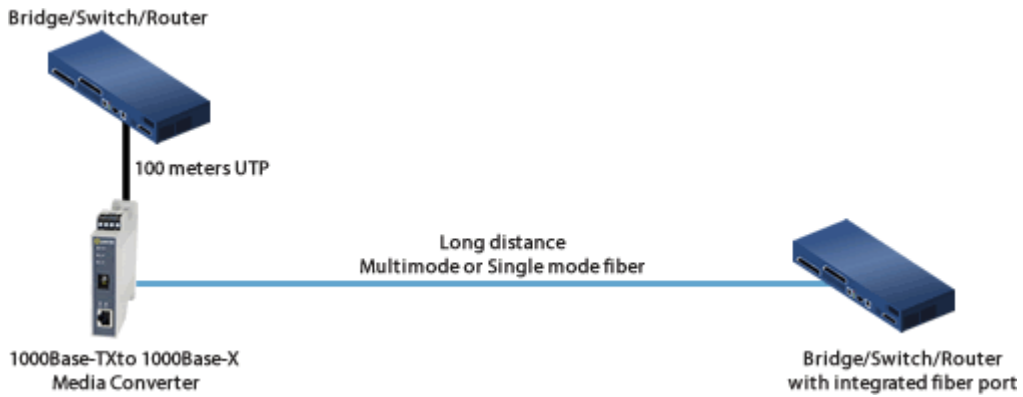

---

### Switch to Gigabit Server

#### Extend the network distance between a Gigabit Switch and a Gigabit File Server

Two Gigabit Ethernet Media Converters can extend the distance between a 1000Base-T Switch and a Gigabit File Server across a fiber link.

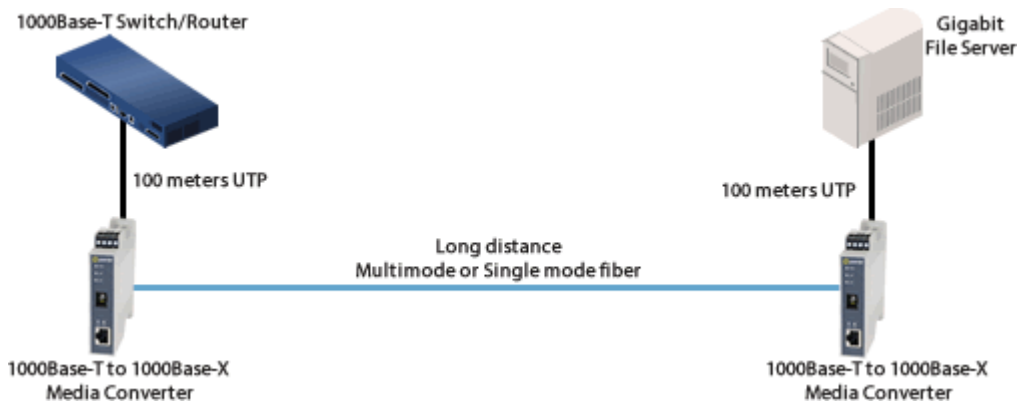

---

### Direct Connect - Long Distance

---

---

### Direct Connection between two remote devices

With a pair of Gigabit Media Converters two devices, such as file servers, can be connected across a fiber link.

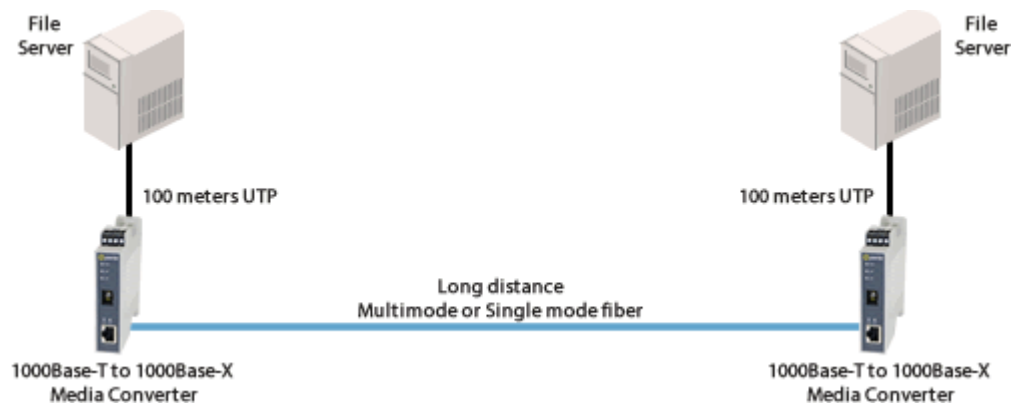

---

### Enterprise Infrastructure

#### Enterprise Infrastructure using Fiber Optics

Create a fiber infrastructure for your enterprise network without any wholesale replacement of existing copper-based equipment.

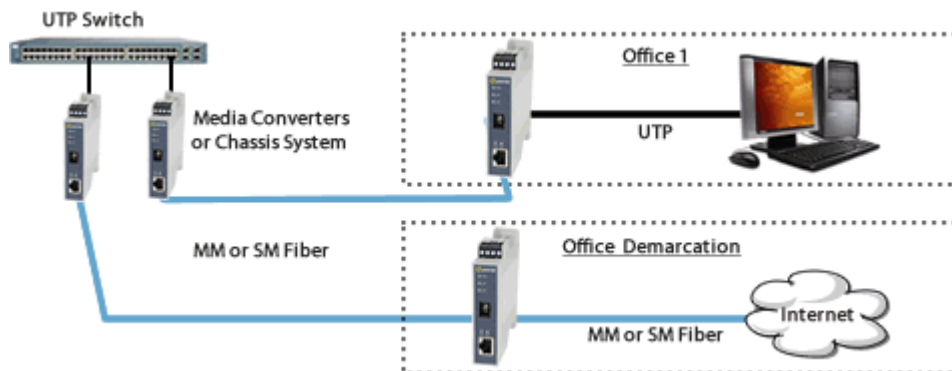

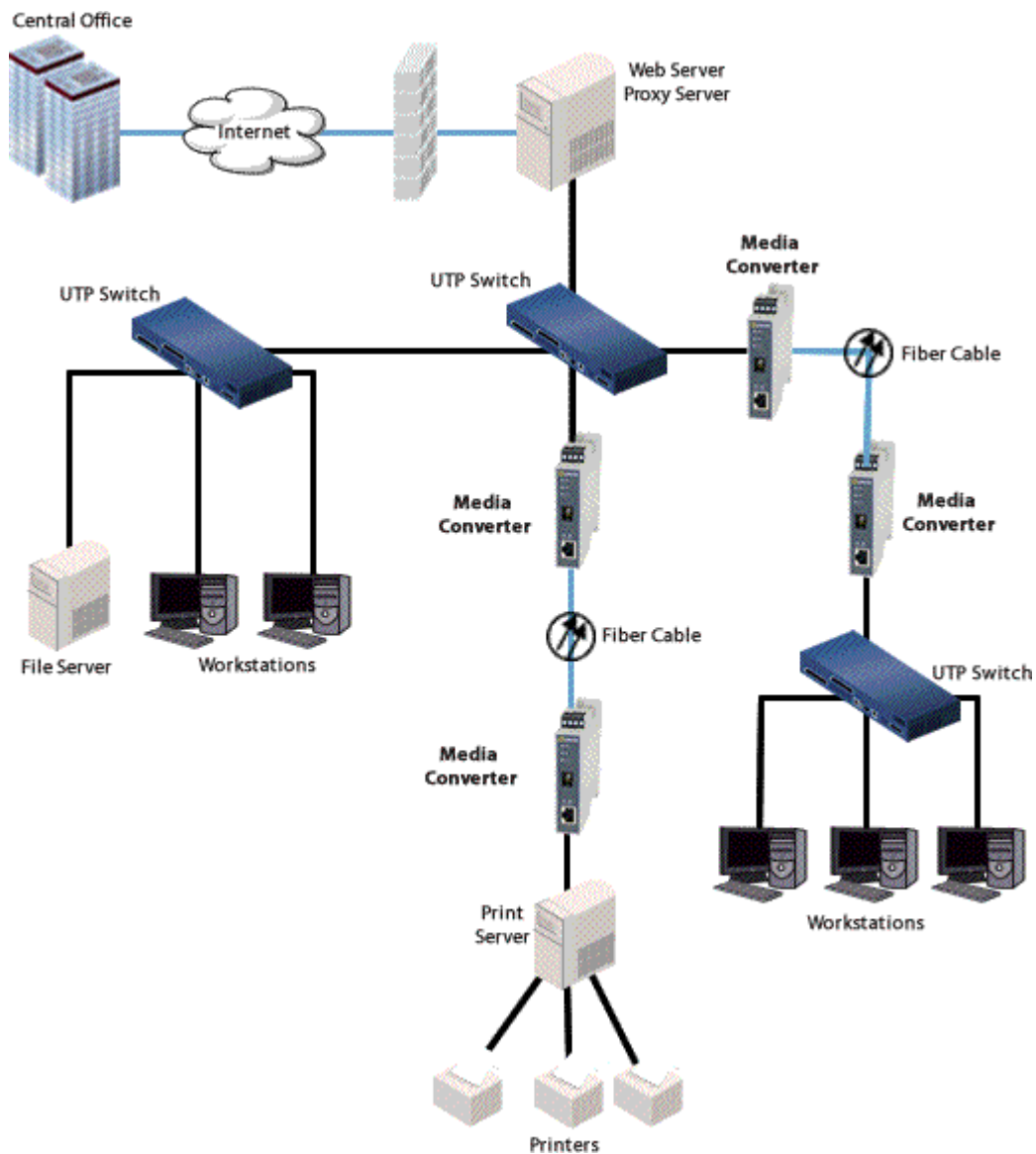

SR-1000-SFP-XT | Gigabit Industrial Media Converter | Perle

Part Number: 05091630

**SR-1000-SFP-XT**- Gigabit Industrial Media Converter: 1000BASE-T (RJ-45) [100 m/328 ft] to 1000BASE-X SFP Slot (empty), -40F to +167F (-40C to +75C) extended operating temperature support. DIN Rail case, terminal block (Combicon) power connector for external power source

Copyright © 1996 - 2022 Perle. All Rights Reserved

