







### Features

- ISM 2.4 GHz Operating Frequency
- Fully Compliant with 2.4 G (IEEE802.15.4/ZigBee Specifications)
- Fully Compliant with ZigBee ZigBee Pro (ZigBee 2007)
- Wireless Transmission Range up to 700 m (Default)
- Adjustable RF Transmission Output Power
- GUI Configuration Software (Windows Version)
- Supports AES-128 Encryption for the Wireless Communication
- DIN-Rail Mountable

## Introduction

The ZT-2510 series module is small-sized wireless ZigBee repeater based on the IEEE802.15.4 standard. It supports network routing and signal relay transmission function in a personal area ZigBee network. The typical transmission of ICP DAS ZT series ZigBee products is 700 meters (LOS, line of sight), with a transmission frequency range of between 2.405 GHz and 2.48 GHz, separated into 5 MHz sectors, providing 16 channels and 16384 PAN IDs. ZT-2000 series is a long distance wireless repeater and you are able to use it to extend the transmission range and improve the quality of wireless signal.

ZT-2000 series products are specification for a suite of high level communication protocols using small, low-power digital radios module, which are fitted the ZigBee 2007 (ZigBee Pro) of ZigBee Alliance. In the ZigBee network, it is only allowed one ZigBee Host and called "ZigBee Coordinator", ZT-2550/ZT-2570 series products, are used to initialize and manager the routing. In addition, One ZigBee network are able to manager 255 ZigBee router and responsible for receiving or bypassing data from parent or child node. In ICP DAS products, the ZT-2551, ZT-2571, ZT-2000 I/O and ZT-2510 are the ZigBee routers.

A Windows compatible GUI configuration utility is available. The utility allows users to set different configurations based on the type of application, together with several of required ZigBee variables such as Pan ID. The friendly user interface is also helping user be familiar with ZT-2000 series.

## Specifications

Models	ZT-2510 (ZigBee Router)
<b>Configuration Interface</b>	
USB	Type B
Cable	CA-USB18 (1.8 M Cable) x 1; USB Type A connector (Type A to Type B cable provided)
Compatibility	USB 1.1 and 2.0 standard
Driver	Windows 98/ME/2000/XP/Vista/7/Linux 2.6.19
<b>LED Indicators</b>	
ZigBee Net	Green
ZigBee Rx/D	Yellow
Power	Red
<b>Power</b>	
Protection	Power Reverse Polarity Protection
EMS Protection	ESD, Surge, EFT
Required Supply Voltage	+10 VDC ~ +30 VDC
Power Consumption	0.5 W
<b>Mechanical</b>	
Casing	Plastic
Flammability	Fire Retardant Materials (UL94-V0 Level)
Dimensions (L x W x H)	87 mm x 33 mm x 110 mm
Installation	DIN-Rail
<b>Environment</b>	
Operating Temperature	-25 ~ +75°C
Storage Temperature	-40 ~ +80°C
Relative Humidity	5 ~ 90% RH, Non-condensing
<b>Wireless</b>	
RF Channel	16
RF Transmit Power	11 dBm
Antenna (2.4GHz)	2.4 GHz - 5 dBi Omni-directional Antenna
Transmit Range (LOS)	700 m (Typical)
Max. Slaves Supported	255
EMI Certification	CE/FCC, FCC ID

**Applications**

**Data Forwarding**

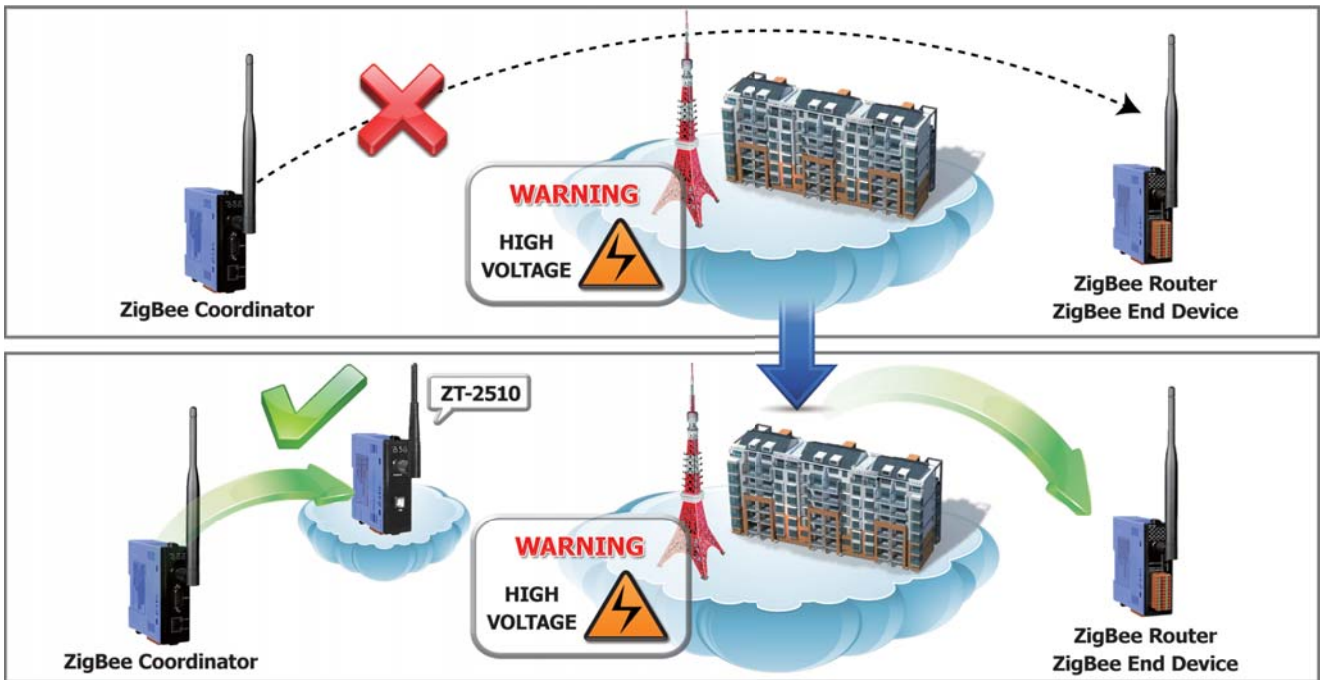

**Communication Range Extension**

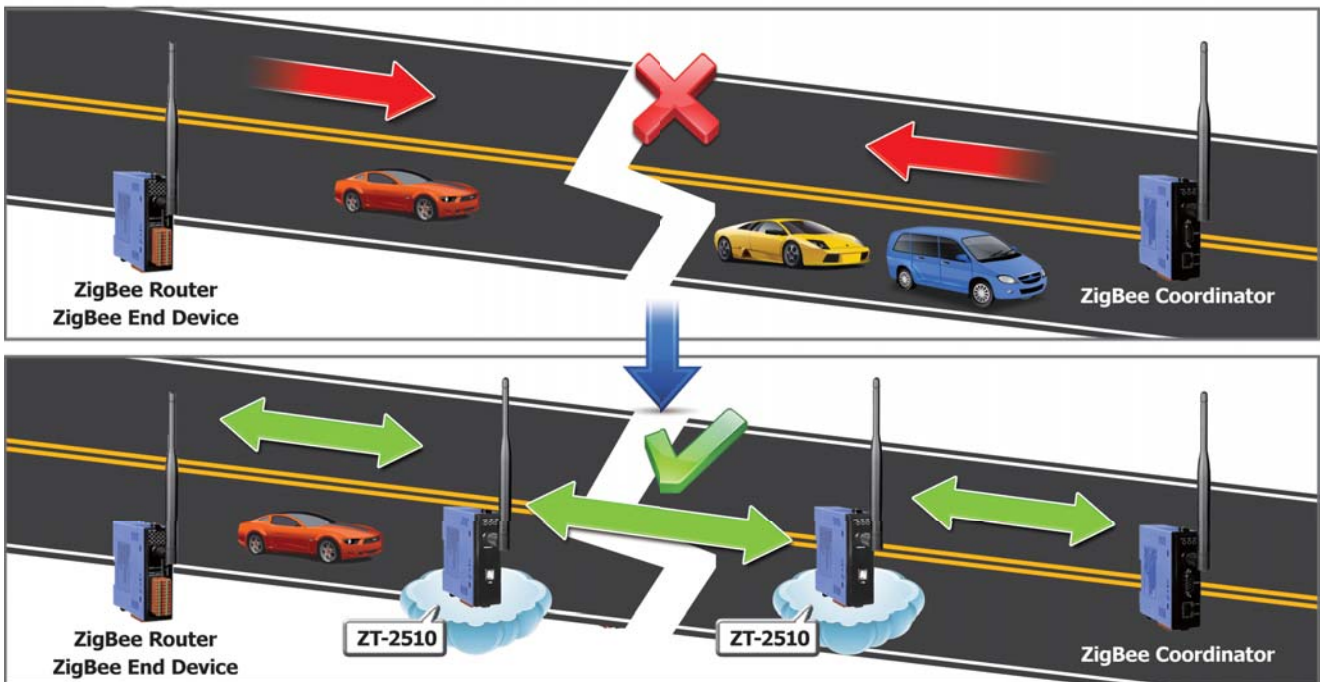

**Redundant Routing**

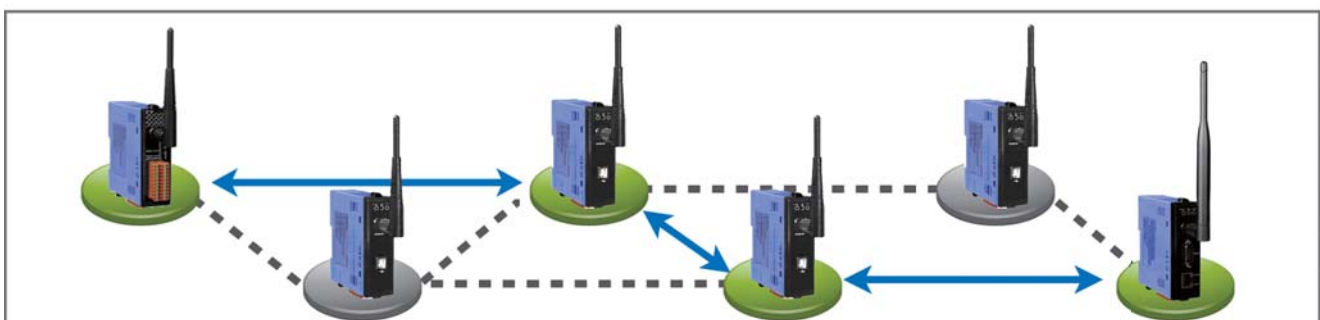

## Appearance

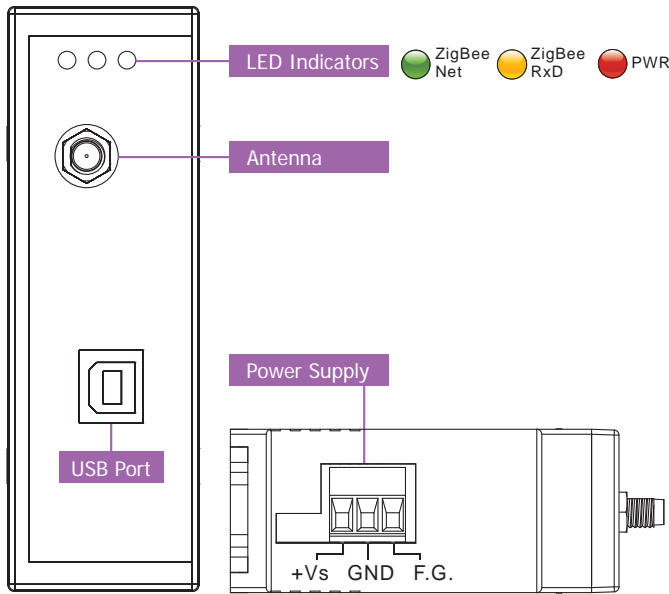

## Dimensions (Units: mm)

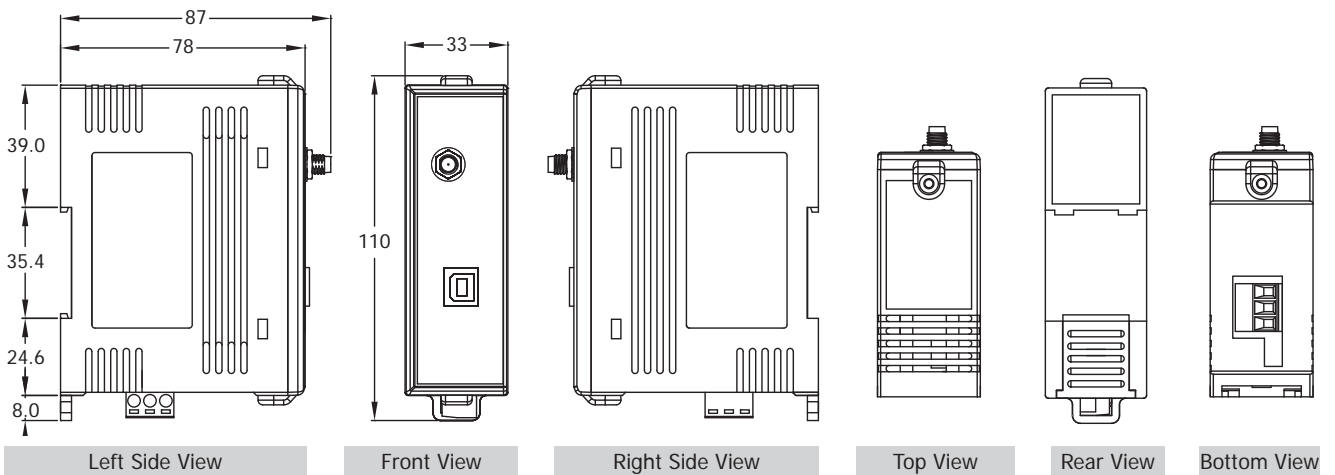

## Ordering Information

ZT-2510 CR	ZigBee Repeater (Slave, ZigBee Router) (RoHS)
------------	---

## Accessories

ZT-2550 CR	RS-485/RS-232 to ZigBee Converter (Host, ZigBee Coordinator) (RoHS)
ZT-2551 CR	RS-485/RS-232 to ZigBee Converter (Slave, ZigBee Router) (RoHS)
ZT-2570 CR	Ethernet/RS-485/RS-232 to ZigBee Converter (Host, ZigBee Coordinator) (RoHS)
ZT-2571 CR	Ethernet/RS-485/RS-232 to ZigBee Converter (Slave, ZigBee Router) (RoHS)
ZT-2000 DIO series	Wireless digital input and digital output ZigBee I/O device
ZT-2000 AIO series	Wireless differential analog input and analog output ZigBee I/O device
Power Supply	12 V/24 V Power Supply
External Antenna	2.4 GHz External Antenna, RP SMA Male (Plug)
Extension Cable	3S00x-1, RG58A/U x Meter Long RP-SMA (male) to RP-SMA (female)