

Data sheet | Item number: 858-307

Relay module; Nominal input voltage: 110 VDC; 4 changeover contacts;
 Limiting continuous current: 5 A; with manual operation; Red status indicator;
 Module width: 31 mm; 1,50 mm²

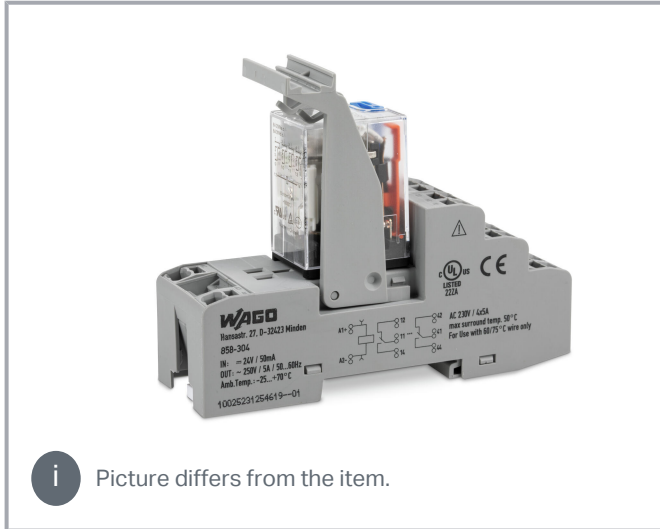

www.wago.com/858-307



i Picture differs from the item.

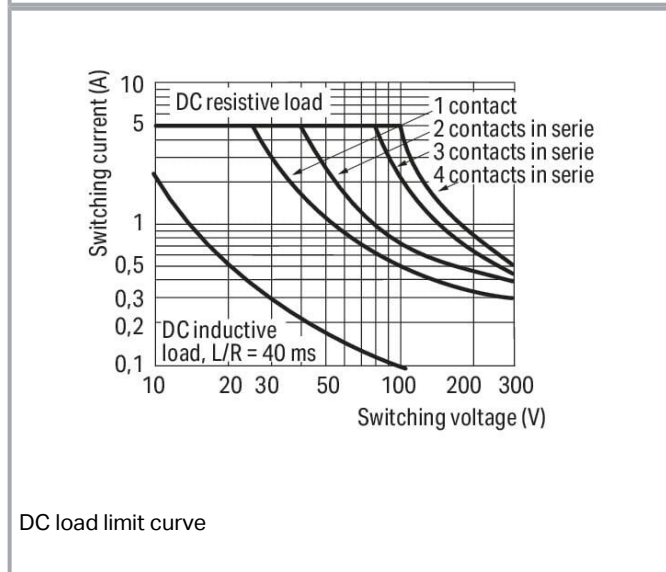
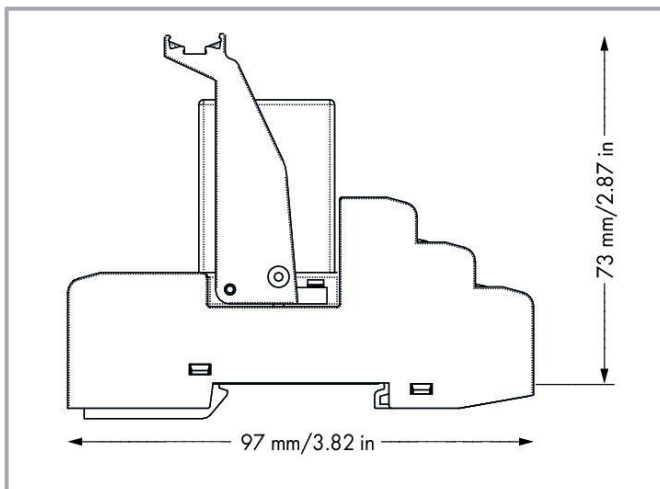
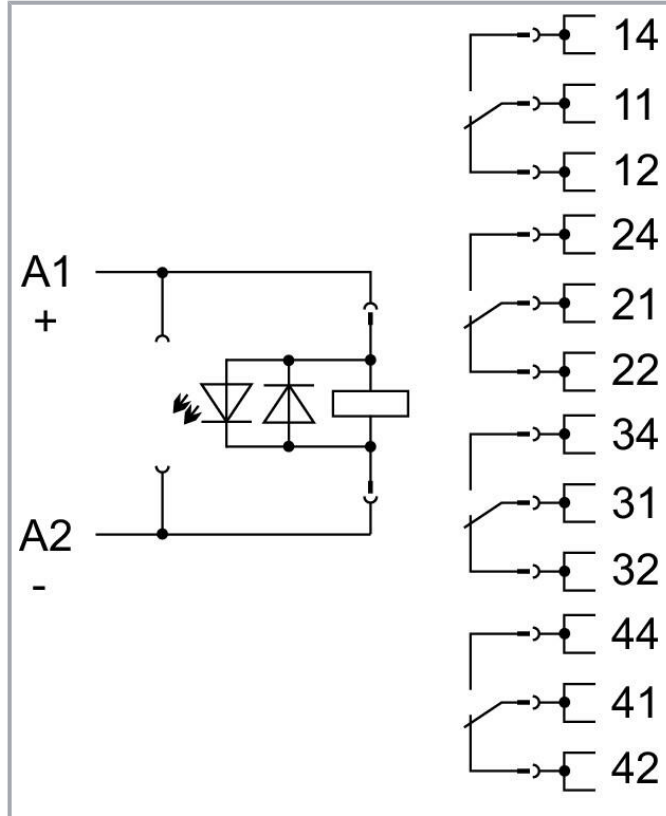

DC load limit curve

Subject to changes. Please also observe the further product documentation!

WAGO GmbH & Co. KG
 Hansastr. 27
 32423 Minden
 Phone: +49571 887-0 | Fax: +49571 887-169
 Email: info.de@wago.com | Web: www.wago.com

Do you have any questions about our products?
 We are always happy to take your call at +49 (571) 887-44222.

Data

Technical data

Control Circuit

Nominal input voltage U_N	DC 110 V
Input voltage range	-20 ... +10 %
Nominal input current at U_N	10 mA

Load circuit

Number of changeover/switchover contacts	4
Contact material (relay)	AgCe
Limiting continuous current	5 A
Inrush current (resistive) max.	(AC) 15 A / 4 s
Switching voltage (max.)	AC 250 V
Switching power (resistive) max.	AC 1250 VA; DC (see load limit curve)
Switching capacity	AC-15: 1 A / AC 240 V; DC-13: 2 A / DC 24 V
Recommended minimum load	12 V / 100 mA
Pull-in time (typ.)	25 ms
Drop-out time (typ.)	25 ms
Bounce time (typ.)	4 ms
Electrical life (NO; resistive load; 23 °C)	100 x 10 ³ switching operations
Mechanical life	20 x 10 ⁶ switching operations

Signaling

Status indicator	Red LED Mechanical
------------------	-----------------------

Safety and protection

Rated voltage	300 V
Rated surge voltage	2.5 kV
Overvoltage category	II
Pollution degree	2
Dielectric strength (control/load circuit) (AC, 1 min)	1.5 kVrms
Dielectric strength (open contact) (AC, 1 min)	1 kVrms
Dielectric strength (load/load circuit) (AC, 1 min)	1.5 kVrms

Subject to changes. Please also observe the further product documentation!



Insulation type (control/load circuit)	Basic insulation
Insulation type (open contact)	Functional insulation
Insulation type (load/load circuit)	Basic insulation
Insulation type (adjacent devices)	Reinforced insulation (safe isolation)
Protection type	IP20

Connection data

Connection technology	Push-in CAGE CLAMP®
Solid conductor	0.34 ... 1.5 mm ² / 22 ... 16 AWG
Fine-stranded conductor	0.34 ... 1.5 mm ² / 22 ... 16 AWG
Strip length	9 ... 10 mm / 0.35 ... 0.39 inches
Note (conductor cross-section)	2 x 0.34 ... 2 x 1.5 mm ² / 1 x 2.5 mm ² / 2 x 22 ... 2 x 16 AWG

Physical data

Width	31 mm / 1.22 inches
Height	97 mm / 3.819 inches
Depth from upper-edge of DIN-rail	73 mm / 2.874 inches

Mechanical data

Mounting type	DIN-35 rail
Mounting position	horizontal (standing/lying); vertical

Material Data

Fire load	1.255 MJ
Weight	95.6 g

Environmental requirements

Ambient temperature (operation at U _N)	-25 ... +70 °C
Ambient temperature UL (operation at U _N)	-25 ... 50 °C
Ambient temperature (storage)	-40 ... +70 °C
Processing temperature	-25 ... +50 °C
Temperature range of connection cable	≥ (T _{ambient} + 25 K)
Relative humidity	5 ... 85 %
Operating altitude (max.)	2000 m

Subject to changes. Please also observe the further product documentation!

Standards and specifications

Standards/specifications	EN 61010-2-201 EN 61810-1 EN 61373 UL 508 (max. 50 °C)
--------------------------	---

Basic relay

WAGO Basic Relay	858-162
------------------	---------

Commercial data

Product Group	6 (INTERFACE ELECTRONIC)
eCl@ss 10.0	27-37-16-01
eCl@ss 9.0	27-37-16-01
ETIM 8.0	EC001437
ETIM 7.0	EC001437
PU (SPU)	5 pcs
Packaging type	box
Country of origin	DE
GTIN	4055143567862
Customs tariff number	85364900990

Environmental Product Compliance

RoHS Compliance Status	Compliant, No Exemption
------------------------	-------------------------

Approvals / Certificates

General approvals

Logo	Approval	Additional Approval Text	Certificate name
	EAC Brjansker Zertifizierungsstelle	TP TC 004/2011	EAC RU C-DE.AM02.B.00122 /19

Declarations of conformity and manufacturer's declarations

Logo	Approval	Additional Approval Text	Certificate name
	EU-Declaration of Conformity WAGO GmbH & Co. KG	-	-

Subject to changes. Please also observe the further product documentation!



UK-Declaration of Conformity
WAGO GmbH & Co. KG

Optional accessories

Jumpers

Jumper



Item no.: 858-402
Jumper; 2-way; insulated; light blue

www.wago.com/858-402

Marking accessories

Marking strip



Item no.: 2009-110
Marking strips; for Smart Printer; on reel; not stretchable; plain; snap-on type; white

www.wago.com/2009-110

Double marker carrier



Item no.: 209-128
Adaptor; gray

www.wago.com/209-128

Marking devices



Item no.: 210-110
Fiber-tip pen

www.wago.com/210-110

Protective marker cover



Item no.: 209-184
Protection cover; transparent

www.wago.com/209-184

Marker



Item no.: 2009-115
WMB-Inline; for Smart Printer; 1500 pieces on roll; stretchable 5 - 5.2 mm; plain; snap-on type; white

www.wago.com/2009-115



Item no.: 209-183
Marker; white















www.wago.com/209-183



Item no.: 793-501
WMB marking card; as card; not stretchable; plain; snap-on type; white

www.wago.com/793-501

Subject to changes. Please also observe the further product documentation!

	Item no.: 793-502 WMB marking card; as card; MARKED; 1 ... 10 (10x); not stretchable; Horizontal marking; snap-on type; white	www.wago.com/793-502
	Item no.: 793-503 WMB marking card; as card; MARKED; 11 ... 20 (10x); not stretchable; Horizontal marking; snap-on type; white	www.wago.com/793-503
	Item no.: 793-504 WMB marking card; as card; MARKED; 21 ... 30 (10x); not stretchable; Horizontal marking; snap-on type; white	www.wago.com/793-504
	Item no.: 793-505 WMB marking card; as card; MARKED; 31 ... 40 (10x); not stretchable; Horizontal marking; snap-on type; white	www.wago.com/793-505
	Item no.: 793-506 WMB marking card; as card; MARKED; 41 ... 50 (10x); not stretchable; Horizontal marking; snap-on type; white	www.wago.com/793-506
	Item no.: 793-566 WMB marking card; as card; MARKED; 1 ... 50 (2x); not stretchable; Horizontal marking; snap-on type; white	www.wago.com/793-566
	Item no.: 793-5501 WMB marking card; as card; for terminal block width 5 - 17.5 mm; stretchable 5 - 5.2 mm; plain; snap-on type; white	www.wago.com/793-5501
Group marker carrier		
	Item no.: 209-145 Group marker carrier; white	www.wago.com/209-145
	Item no.: 249-105 Group marker carrier; gray	www.wago.com/249-105
Mounting		
Socket without relay		
	Item no.: 858-110 Ejector; for basic relays 25 mm x 35 mm	www.wago.com/858-110
Ferrule		
Ferrule		
	Item no.: 216-241 Ferrule; Sleeve for 0.5 mm ² / 20 AWG; insulated; electro-tin plated; electrolytic copper; gastight crimped; acc. to DIN 46228, Part 4/09.90; white	www.wago.com/216-241
	Item no.: 216-242 Ferrule; Sleeve for 0.75 mm ² / 18 AWG; insulated; electro-tin plated; electrolytic copper; gastight crimped; acc. to DIN 46228, Part 4/09.90; gray	www.wago.com/216-242
	Item no.: 216-243 Ferrule; Sleeve for 1 mm ² / AWG 18; insulated; electro-tin plated; electrolytic copper; gastight crimped; acc. to DIN 46228, Part 4/09.90; red	www.wago.com/216-243
	Item no.: 216-244	

Subject to changes. Please also observe the further product documentation!

Ferrule; Sleeve for 1.5 mm² / AWG 16; insulated; electro-tin plated; electrolytic copper; gastight crimped; acc. to DIN 46228, Part 4/09.90; black

www.wago.com/216-244

Tool

Operating tool



Item no.: 210-719

Operating tool; Blade: 2.5 x 0.4 mm; with a partially insulated shaft

www.wago.com/210-719

Downloads

Documentation

Bid Text

858-307 docx - Datei	2019 Feb 20	docx 17.3 kB	Download
858-307 X81 - Datei	2019 Feb 19	xml 4.8 kB	Download

Instruction Leaflet

Stecksocket für Elementarrelais	V 2.0.0 2022 Jan 25	pdf 2.2 MB	Download
---------------------------------	------------------------	---------------	----------

Additional Information

Disposal and Recycling Electrical and electronic equipment, Batteries, Packaging	V 1.1.0 2022 Aug 18	pdf 2.2 MB	Download
---	------------------------	---------------	----------

CAD/CAE-Data

CAD data

2D/3D Models 858-307	URL	Download
----------------------	-----	----------

CAE data

EPLAN Data Portal 858-307	URL	Download
---------------------------	-----	----------

WSCAD Universe 858-307	URL	Download
------------------------	-----	----------

ZUKEN Portal 858-307	URL	Download
----------------------	-----	----------

Subject to changes. Please also observe the further product documentation!

WAGO GmbH & Co. KG
 Hansastr. 27
 32423 Minden
 Phone: +49571 887-0 | Fax: +49571 887-169
 Email: info.de@wago.com | Web: www.wago.com

Do you have any questions about our products?
 We are always happy to take your call at +49 (571) 887-44222.

Environmental Product Compliance

Compliance Search

Environmental Product Compliance 858-307

URL

Download

Relay module; Nominal input voltage: 110 VDC; 4 changeover contacts; Limiting continuous current: 5 A; with manual operation; Red status indicator; Module width: 31 mm; 1,50 mm²

Installation Notes

Commoning

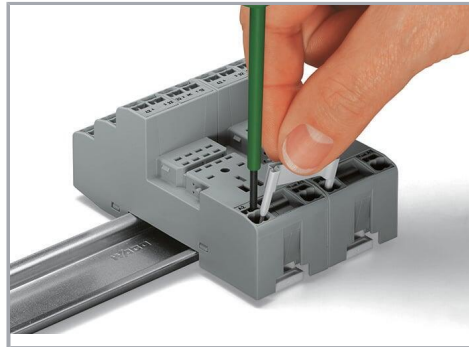
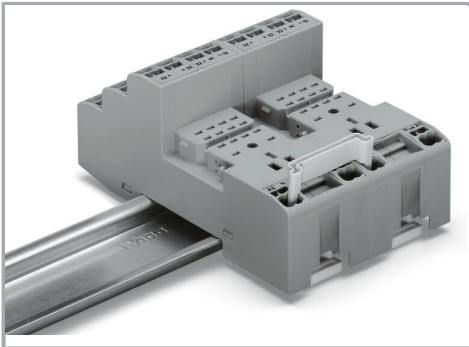

Removing a jumper via screwdriver.

Marking

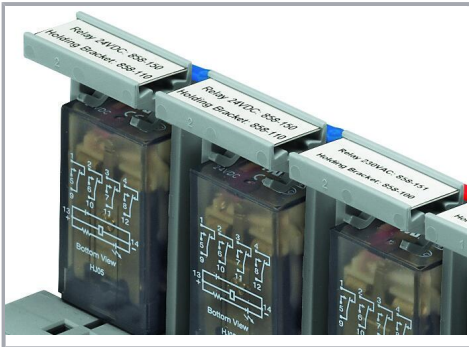

Marking using WMB Multi markers and group marker carriers.

Subject to changes. Please also observe the further product documentation!