

Couplers

0.5-18 GHz

SMA Miniature Stripline Coaxial Couplers

- Smallest, Lightest Units Available from 0.5 to 18 GHz
- Highest Directivity, Lowest VSWR
- Excellent Frequency Flatness
- Operational to 105°C without Degradation (125°C Storage)



Specifications

SMA (F), 0.5 to 18 GHz, 50 W

FREQUENCY RANGE (GHz)	MODEL	COUPLING (dB)	DIRECTIVITY (dB min.)	INSERTION LOSS (dB)		VSWR		FREQUENCY SENSITIVITY* (dB max.)	POWER INPUT (W)	REFLECTED POWER		WEIGHT (max.)	
				EXCLUDING COUPLED POWER	TRUE	PRIMARY LINE (max.)	SECONDARY LINE (max.)			AVG. (W)	PEAK (kW)	oz.	gr.
0.5-1	4011C-10	10 ±1.25	25	0.20	0.80	1.15	1.15	±0.75	50	5	3	1.3	37
	4011C-20	20 ±1.25	25	0.20	0.80	1.15	1.15	±0.75	50	50	3	1.2	34
1-2	4012C-6	6 ±1.00	25	0.20	1.80	1.15	1.15	±0.60	50	2	3	0.9	26
	4012C-10	10 ±1.25	25	0.20	0.90	1.10	1.10	±0.75	50	5	3	0.9	26
	4012C-20	20 ±1.25	27	0.20	0.20	1.10	1.10	±0.75	50	50	3	0.9	26
	4012C-30	30 ±1.25	27	0.20	0.20	1.10	1.10	±0.75	50	50	3	0.9	26
2-4	4013C-6	6 ±1.00	22	0.20	1.80	1.15	1.15	±0.60	50	2	3	0.6	18
	4013C-10	10 ±1.25	22	0.25	0.80	1.15	1.15	±0.75	50	5	3	0.6	18
	4013C-20	20 ±1.25	22	0.20	0.25	1.15	1.15	±0.75	50	50	3	0.6	18
0.5-8	4013C-30	30 ±1.25	22	0.20	0.20	1.15	1.15	±0.75	50	50	3	0.6	18
	4216-10	10 ±1.50	15	—	1.40	1.40	1.40	—	50	5	3	2.1	60
	4216-20	20 ±1.50	14	—	0.80	1.30	1.30	—	50	50	3	2.1	60
4-8	4014C-6	6 ±1.00	18	0.25	2.00	1.25	1.25	±0.60	50	2	3	0.6	18
	4014C-10	10 ±1.25	20	0.25	1.00	1.25	1.25	±0.75	50	5	3	0.6	18
	4014C-20	20 ±1.25	20	0.25	0.30	1.25	1.25	±0.75	50	50	3	0.6	18
	4014C-30	30 ±1.25	20	0.25	0.25	1.25	1.25	±0.75	50	50	3	0.6	18
7-12.4	4015C-6	6 ±1.00	15	0.40	2.00	1.30	1.30	±0.50	50	2	3	0.8	23
	4015C-10	10 ±1.25	17	0.40	1.00	1.30	1.30	±0.50	50	5	3	0.8	23
	4015C-20	20 ±1.00	17	0.30	0.35	1.25	1.25	±0.50	50	50	3	0.8	23
	4015C-30	30 ±1.00	17	0.30	0.30	1.25	1.25	±0.50	50	50	3	0.8	23
7.5-16	4055-6**	6 ±1.10	12	0.60	2.00	1.35	1.40	±0.60	50	2	2	0.8	23
	4055-10**	10 ±1.50	12	0.60	1.00	1.35	1.40	±0.75	50	5	2	0.8	23
	4055-20**	20 ±1.25	15	0.50	0.50	1.35	1.40	±0.75	50	50	2	0.8	23
	4055-30**	30 ±1.25	15	0.50	0.50	1.35	1.40	±0.75	50	50	2	0.8	23
12.4-18	4016D-6	6 ±1.00	15	0.30	2.00	1.35	1.40	±0.50	50	2	1	0.7	20
	4016D-10	10 ±1.00	15	0.55	1.10	1.35	1.40	±0.50	50	5	1	0.7	20
	4016C-20	20 ±1.00	15	0.50	0.55	1.30	1.40	±0.50	50	50	1	0.8	23
	4016C-30**	30 ±1.00	15	0.50	0.55	1.30	1.40	±0.50	50	50	1	0.8	23

* Frequency Sensitivity included in coupling

** Special order devices. Minimum quantity may apply.

Outline Drawings

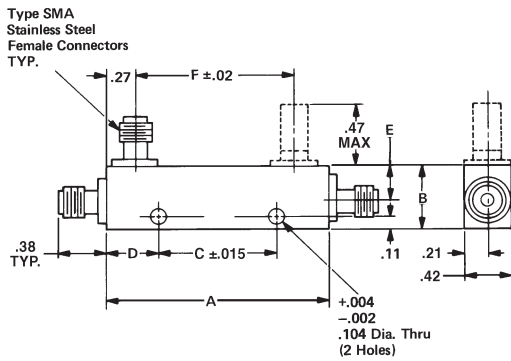

Allow .020 max. sealant build-up per surface.

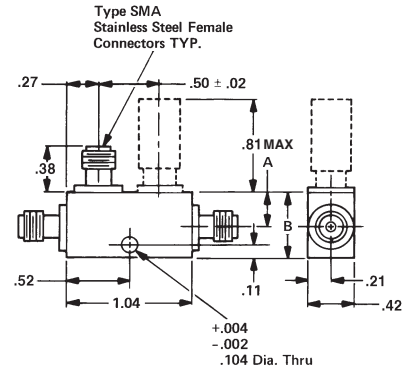

Allow .020 max. sealant build-up per surface.

MODEL	A	B	C	D	E	F
4011C-10	3.06	.58	1.500	.78	.34	2.52
4011C-20	3.04	.55	1.750	.65	.30	2.50
4012C-6	1.82	.55	.938	.44	.30	1.28
4012C-10, -20	1.82	.55	.938	.44	.30	1.28
4012C-30	1.82	.58	.938	.44	.34	1.28
4013C-6	1.20	.55	.344	.43	.30	.66
4013C-10, -20	1.20	.55	.344	.43	.30	.66
4013C-30	1.20	.59	.344	.43	.35	.66

MODEL	Max. Dimensions	
	A	B
4014C-6, -10, -20	.30	.54
4014C-30	.34	.58
4015C-6, -10, -20	.30	.55
4015C-30	.43	.67
4016D-6, -10	.30	.55
4016C-20, -30	.43	.67
4055-6, -10	.30	.55
4055-20, -30	.43	.67

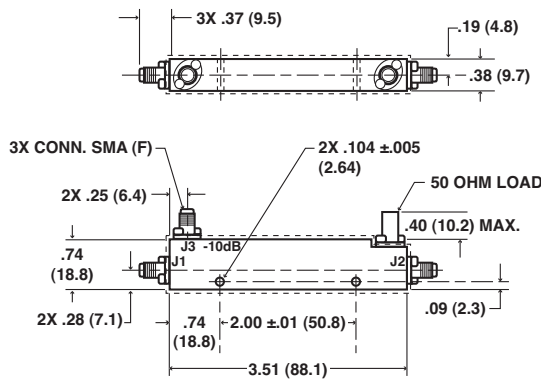

NOTES:

1. Dotted area represents .020 max. build-up of sealant per surface.
2. Connectors mate without interference per MIL-STD-348.

TOL:
XX ±.02 (.51)

MODELS 4216-10, 4216-20

Dimensions in inches (mm in parentheses), unless otherwise specified.

