

CARRIER TAPE SPEC FOR SMT SINGLE VERTICAL HEADER OF NANO-FIT					
CARRIER TAPE NUMBER	DIM A	DIM B	DIM D	DIM E	DIM F
105431-8001	24.00	N/A	11.50	8.63	6.97
105431-8002	24.00	N/A	11.50	11.13	9.47
105431-8003	32.00	28.40	14.20	13.63	11.97
105431-8004	32.00	28.40	14.20	16.13	14.47
105431-8005	44.00	40.40	20.20	18.63	16.97
105431-8006	44.00	40.40	20.20	21.13	19.47
105431-8007	44.00	40.40	20.20	23.63	21.97

NOTES :  
1. REELING DIRECTION IN DELIVERY.

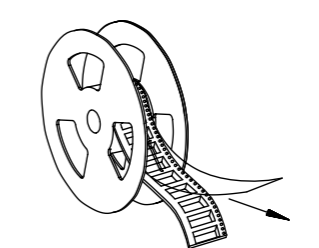

USER FEEDING DIRECTION



SECTION B-B

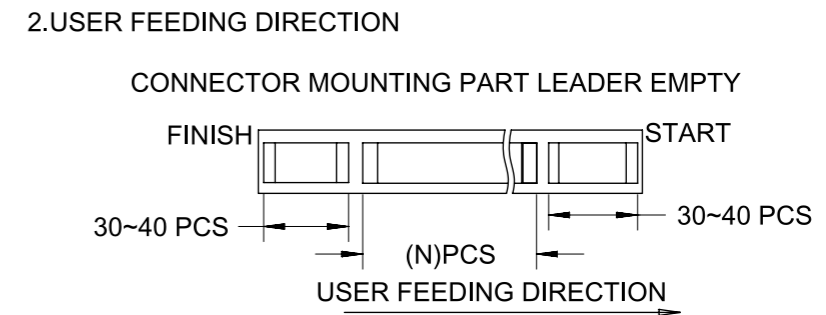

3. COVER TAPE PEELING FORCE

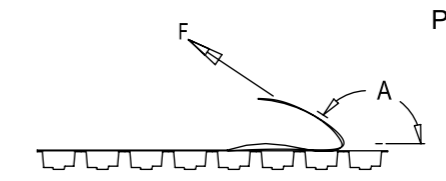

PEELING SPEED 300mm/Min.(REF.)

A	170°~180°
F	0.1N~1.3N

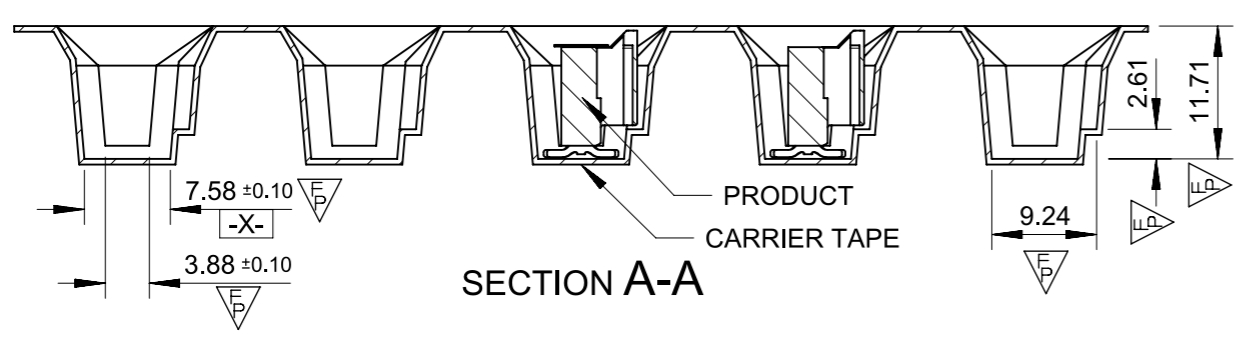

SECTION A-A

USER FEEDING DIRECTION

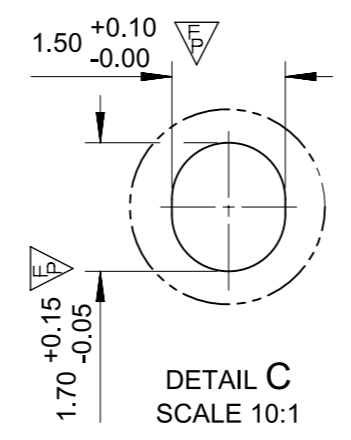

DETAIL C  
SCALE 10:1

NANO-FIT CONNECTOR FULLY LOADED

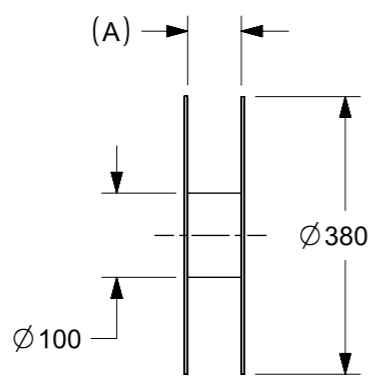
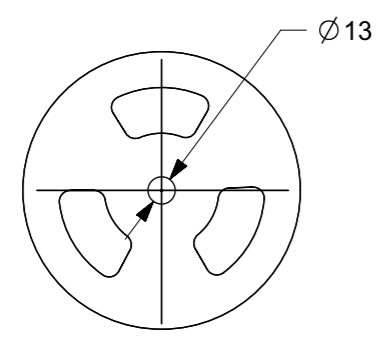
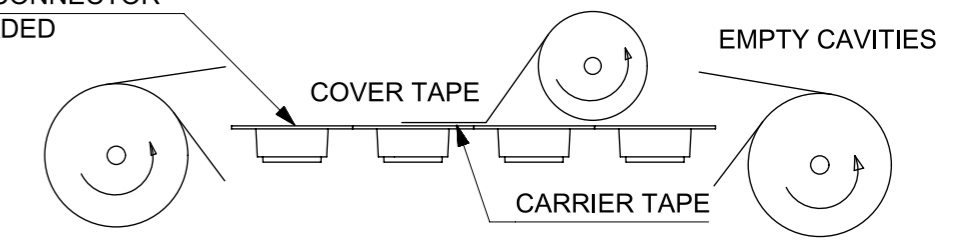

FUNCTIONAL SYMBOLS		THIS DRAWING CONTAINS INFORMATION THAT IS PROPRIETARY TO MOLEX ELECTRONIC TECHNOLOGIES, LLC AND SHOULD NOT BE USED WITHOUT WRITTEN PERMISSION		CURRENT REV DESC:		<b>molex</b>	
▽A = 0	mm	SCALE	1:1				
GENERAL TOLERANCES (UNLESS SPECIFIED)						PACKING DRAWING FOR NANO-FIT	
▽E = 0	ANGULAR TOL		±	°		PRODUCT CUSTOMER DRAWING	
▽F = 0	4 PLACES	±					DOCUMENT NUMBER
DIVISIONAL SYMBOLS		3 PLACES	±			1054311000-PK	
		2 PLACES	±	0.13			DOC TYPE
		1 PLACE	±	0.25			DOC PART
		0 PLACES	±				REVISION
DRAFT WHERE APPLICABLE MUST REMAIN WITHIN DIMENSIONS		THIRD ANGLE PROJECTION		DRAWING	SERIES	MATERIAL NUMBER	CUSTOMER
		A3-SIZE		105431	GENERAL MARKET		SHEET NUMBER
						1 OF 2	



REEL	COVER TAPE	CARRIER TAPE	PRODUCT NUMBER		PARTS PER REEL	REELS PER CARTON	PARTS PER CARTON	
885961399	894990121	105431-8001	WITH MYLAR	105431-1102, 105431-1202, 105431-1302, 105431-1402	300	3	900	
			WITHOUT MYLAR	105431-1502, 105431-1602, 105431-1702, 105431-1802				
			WITHOUT MYLAR	105431-2502, 105431-2602, 105431-2702, 105431-2802				
		105431-8002	WITH MYLAR	105431-1103, 105431-1203, 105431-1303, 105431-1403				
			WITHOUT MYLAR	105431-1503, 105431-1603, 105431-1703, 105431-1803				
			WITHOUT MYLAR	105431-2503, 105431-2603, 105431-2703, 105431-2803				
885961400	894990122	105431-8003	WITH MYLAR	105431-1104, 105431-1204, 105431-1304, 105431-1404	300	3	900	
			WITHOUT MYLAR	105431-1504, 105431-1604, 105431-1704, 105431-1804				
			WITHOUT MYLAR	105431-2504, 105431-2604, 105431-2704, 105431-2804				
		105431-8004	WITH MYLAR	105431-1105, 105431-1205, 105431-1305, 105431-1405				
			WITHOUT MYLAR	105431-1505, 105431-1605, 105431-1705, 105431-1805				
			WITHOUT MYLAR	105431-2505, 105431-2605, 105431-2705, 105431-2805				
885961401	894990123	105431-8005	WITH MYLAR	105431-1106, 105431-1206, 105431-1306, 105431-1406	300	2	600	
			WITHOUT MYLAR	105431-1506, 105431-1606, 105431-1706, 105431-1806				
			WITHOUT MYLAR	105431-2506, 105431-2606, 105431-2706, 105431-2806				
			105431-8006	WITH MYLAR				105431-1107, 105431-1207, 105431-1307, 105431-1407
				WITHOUT MYLAR				105431-1507, 105431-1607, 105431-1707, 105431-1807
				WITHOUT MYLAR				105431-2507, 105431-2607, 105431-2707, 105431-2807
		105431-8007	WITH MYLAR	105431-1108, 105431-1208, 105431-1308, 105431-1408	300	2	600	
			WITHOUT MYLAR	105431-1508, 105431-1608, 105431-1708, 105431-1808				
			WITHOUT MYLAR	105431-2508, 105431-2608, 105431-2708, 105431-2808				

- NOTES :
1. STAPLES SHOULD ONLY BE USED TO SET UP CARTON. ALL CARTONS CLOSURES MUST BE DONE WITH TAPE.
  2. FILL PACKAGING BAGS WITH THE QUANTITIES AS INDICATED IN THE CHART



THIS DRAWING CONTAINS INFORMATION THAT IS PROPRIETARY TO MOLEX ELECTRONIC TECHNOLOGIES, LLC AND SHOULD NOT BE USED WITHOUT WRITTEN PERMISSION									
FUNCTIONAL SYMBOLS	DIMENSION UNITS	SCALE	CURRENT REV DESC:						
$\nabla_A = 0$	mm	1:1	<b>molex</b> PACKING DRAWING FOR NANO-FIT PRODUCT CUSTOMER DRAWING						
$\nabla_E = 0$	GENERAL TOLERANCES (UNLESS SPECIFIED)								
$\nabla_P = 0$	ANGULAR TOL ± °								
DIVISIONAL SYMBOLS	4 PLACES ±								
	3 PLACES ±		EC NO: 670810						
	2 PLACES ± 0.13		DRWN: GLLI 2021/07/21						
	1 PLACE ± 0.25		CHK'D: YXZHENG 2021/07/22						
	0 PLACES ±		APPR: YXZHENG 2021/07/22						
DRAFT WHERE APPLICABLE MUST REMAIN WITHIN DIMENSIONS			THIRD ANGLE PROJECTION		DRAWING	SERIES	MATERIAL NUMBER	CUSTOMER	SHEET NUMBER
					A3-SIZE	105431	1054311000-PK	GENERAL MARKET	2 OF 2

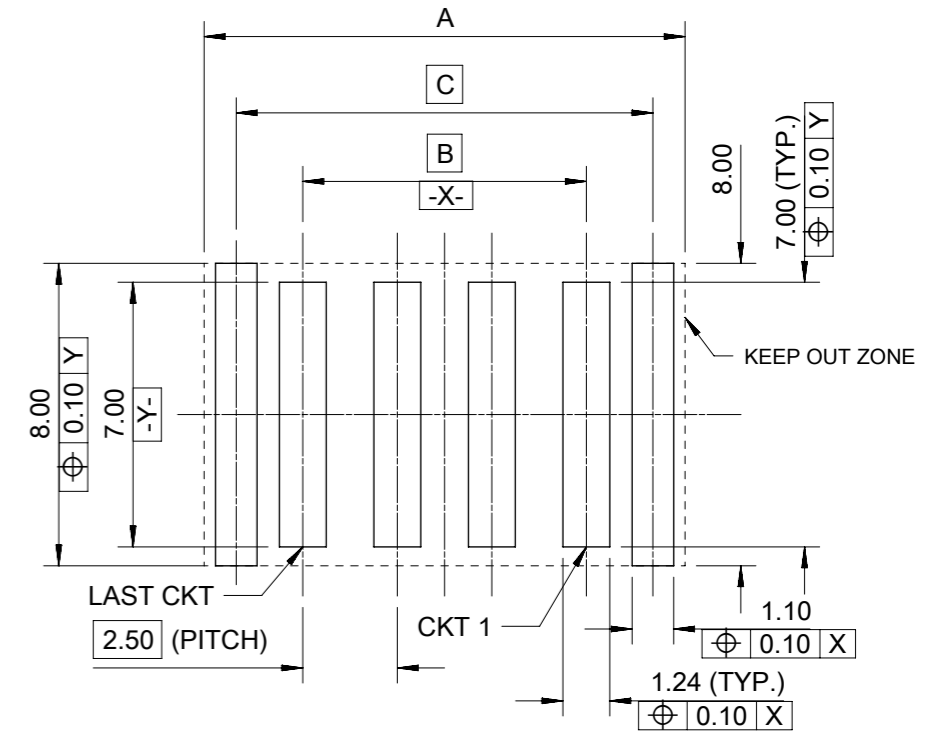
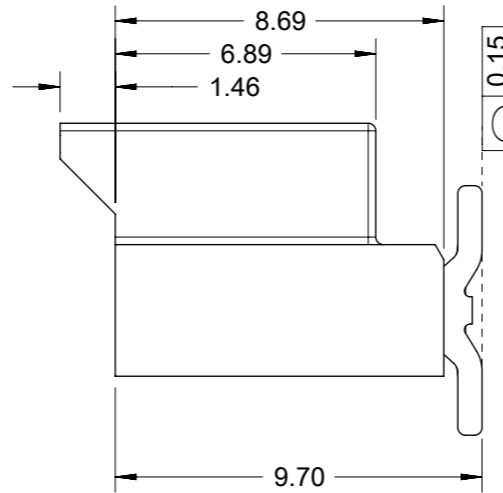

RECOMMENDED PCB LAYOUT(CONNECTOR SIDE VIEW)  
THICKNESS=1.60mm MIN. TOLERANCE:±0.05



WITHOUT MYLAR



WITH MYLAR

THIS DRAWING CONTAINS INFORMATION THAT IS PROPRIETARY TO MOLEX ELECTRONIC TECHNOLOGIES, LLC AND SHOULD NOT BE USED WITHOUT WRITTEN PERMISSION											
<b>QUALITY SYMBOLS</b> ▽A = 0 ▽E = 0 ▽F = 0 ▼ = 0 ▽C = 0 ⊠ = 0 ■ = 0 ▽ = 0	2021/04/27	2021/07/22	2021/07/22	GENERAL TOLERANCES (UNLESS SPECIFIED)		DIMENSION UNITS	SCALE				
	2021/04/27	2021/07/22	2021/07/22	ANGULAR TOL ± 3.0 °		mm	5:1				
	EC NO: 670810 DRWN: GLLI CHK'D: YXZHENG APPR: YXZHENG	4 PLACES	±	DRWN BY		DATE	WJHUO		2014/10/30		
		3 PLACES	±	CHK'D BY		DATE					
		2 PLACES	± 0.2	APPR BY		DATE	AYIN		2015/03/12		
		1 PLACE	± 0.3	DRAWING SIZE		THIRD ANGLE PROJECTION	A3				
		0 PLACES	±	DRAFT WHERE APPLICABLE MUST REMAIN WITHIN DIMENSIONS							
	RELEASE STATUS		P1	RELEASE DATE		2021/07/22	09:31:37	SD DRAWING FOR		NANO-FIT HEADER OF SMT VERTICAL SINGLE CONN.	
	PRODUCT CUSTOMER DRAWING		SERIES	MATERIAL NUMBER		CUSTOMER					
	DOCUMENT NUMBER		SD-105431-001		DOC TYPE	PSD	DOC PART	000	SHEET NUMBER		1 OF 4

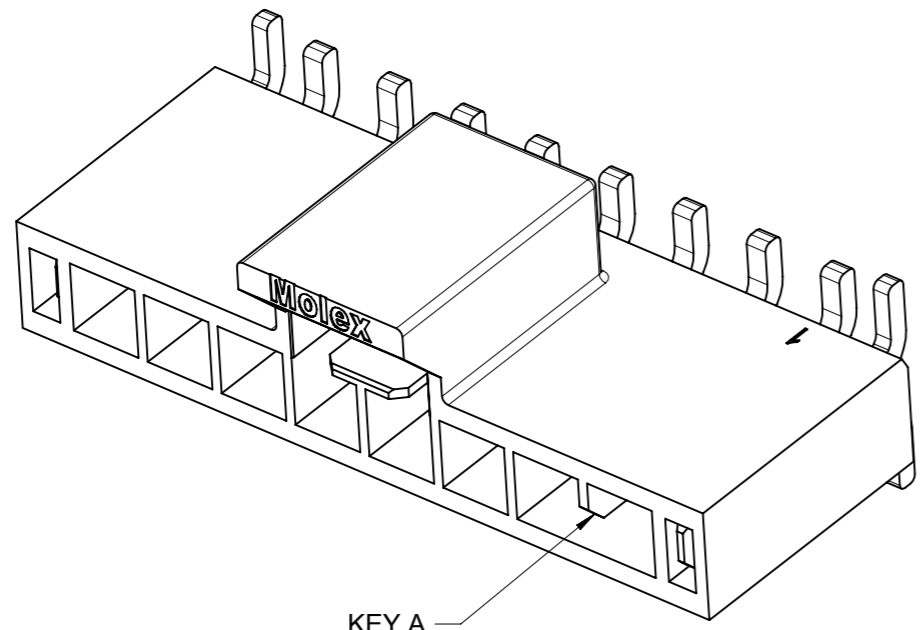

KEY A

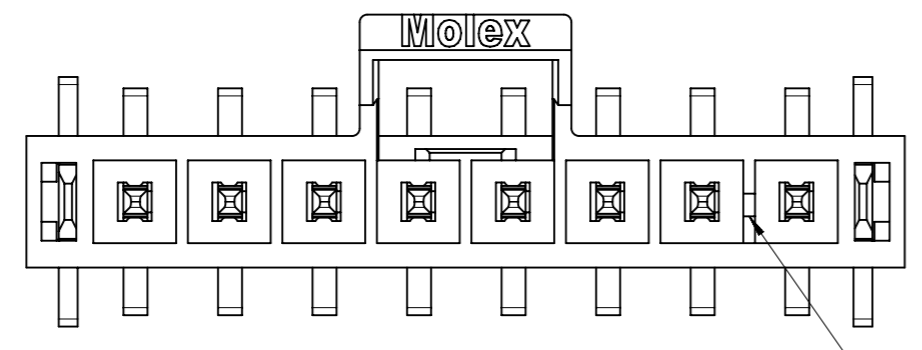

KEY A

BLACK

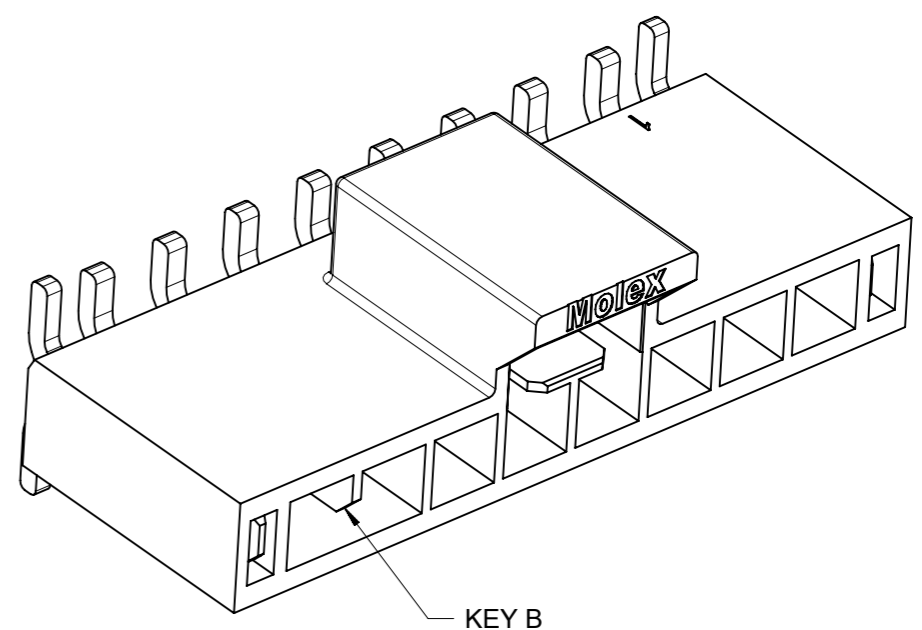

KEY B

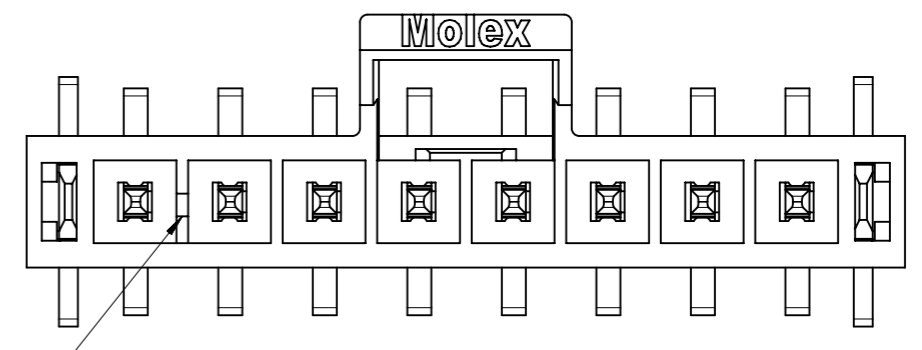

KEY B

NATURAL

COLOR OPTION

<b>SYMBOLS</b> ▽ = 0 ▽ = 0 ▽ = 0 ▽ = 0 ▽ = 0 ▽ = 0 ▽ = 0 ▽ = 0 ▽ = 0 ▽ = 0 ▽ = 0 ▽ = 0	THIS DRAWING CONTAINS INFORMATION THAT IS PROPRIETARY TO MOLEX ELECTRONIC TECHNOLOGIES, LLC AND SHOULD NOT BE USED WITHOUT WRITTEN PERMISSION	CURRENT REV DESC:			
	DIMENSION UNITS	SCALE	EC NO: 670810		
	mm		DRWN: GLLI		2021/04/27
	GENERAL TOLERANCES (UNLESS SPECIFIED)		CHK'D: YXZHENG		2021/07/22
ANGULAR TOL ± 3.0°		APPR: YXZHENG	2021/07/22	PRODUCT CUSTOMER DRAWING	
4 PLACES ±	INITIAL REVISION:		DOCUMENT NUMBER	DOC TYPE	
3 PLACES ±	DRWN: RMV02		SD-105431-001	PSD	
2 PLACES ± 0.2	APPR: AYIN		000	D1	
1 PLACE ± 0.3	THIRD ANGLE PROJECTION		MATERIAL NUMBER	CUSTOMER	
0 PLACES ±	DRAWING		GENERAL MARKET	SHEET NUMBER	
DRAFT WHERE APPLICABLE MUST REMAIN WITHIN DIMENSIONS	A3-SIZE		105431	2 OF 4	

DOCUMENT STATUS	P1	RELEASE DATE	2021/07/22	09:31:37
-----------------	----	--------------	------------	----------

9		8			7		6		5		4		3			2		1	
PART NUMBER (WITH MYLAR)	PART NUMBER (WITHOUT MYLAR)	DIM. A	DIM. B	DIM. C	CKT SIZE	PLATING	LUBE					PART NUMBER (WITH MYLAR)	PART NUMBER (WITHOUT MYLAR)	DIM. A	DIM. B	DIM. C	CKT SIZE	PLATING	LUBE
105431-1102	105431-1502	8.23	2.50	6.11	2	TIN						105431-2102	105431-2502	8.23	2.50	6.11	2	TIN	
105431-1103	105431-1503	10.73	5.00	8.61	3							105431-2103	105431-2503	10.73	5.00	8.61	3		
105431-1104	105431-1504	13.23	7.50	11.11	4							105431-2104	105431-2504	13.23	7.50	11.11	4		
105431-1105	105431-1505	15.73	10.00	13.61	5							105431-2105	105431-2505	15.73	10.00	13.61	5		
105431-1106	105431-1506	18.23	12.50	16.11	6							105431-2106	105431-2506	18.23	12.50	16.11	6		
105431-1107	105431-1507	20.73	15.00	18.61	7							105431-2107	105431-2507	20.73	15.00	18.61	7		
105431-1108	105431-1508	23.23	17.50	21.11	8							105431-2108	105431-2508	23.23	17.50	21.11	8		
105431-1202	105431-1602	8.23	2.50	6.11	2							GOLD 0.38	NO						
105431-1203	105431-1603	10.73	5.00	8.61	3	105431-2203	105431-2603	10.73	5.00	8.61	3								
105431-1204	105431-1604	13.23	7.50	11.11	4	105431-2204	105431-2604	13.23	7.50	11.11	4								
105431-1205	105431-1605	15.73	10.00	13.61	5	105431-2205	105431-2605	15.73	10.00	13.61	5								
105431-1206	105431-1606	18.23	12.50	16.11	6	105431-2206	105431-2606	18.23	12.50	16.11	6								
105431-1207	105431-1607	20.73	15.00	18.61	7	105431-2207	105431-2607	20.73	15.00	18.61	7								
105431-1208	105431-1608	23.23	17.50	21.11	8	105431-2208	105431-2608	23.23	17.50	21.11	8								
105431-1302	105431-1702	8.23	2.50	6.11	2	GOLD 0.76												105431-2302	105431-2702
105431-1303	105431-1703	10.73	5.00	8.61	3							105431-2303	105431-2703	10.73	5.00	8.61	3		
105431-1304	105431-1704	13.23	7.50	11.11	4							105431-2304	105431-2704	13.23	7.50	11.11	4		
105431-1305	105431-1705	15.73	10.00	13.61	5							105431-2305	105431-2705	15.73	10.00	13.61	5		
105431-1306	105431-1706	18.23	12.50	16.11	6							105431-2306	105431-2706	18.23	12.50	16.11	6		
105431-1307	105431-1707	20.73	15.00	18.61	7							105431-2307	105431-2707	20.73	15.00	18.61	7		
105431-1308	105431-1708	23.23	17.50	21.11	8							105431-2308	105431-2708	23.23	17.50	21.11	8		
105431-1402	105431-1802	8.23	2.50	6.11	2							GOLD 0.76	YES					105431-2402	105431-2802
105431-1403	105431-1803	10.73	5.00	8.61	3	105431-2403	105431-2803	10.73	5.00	8.61	3								
105431-1404	105431-1804	13.23	7.50	11.11	4	105431-2404	105431-2804	13.23	7.50	11.11	4								
105431-1405	105431-1805	15.73	10.00	13.61	5	105431-2405	105431-2805	15.73	10.00	13.61	5								
105431-1406	105431-1806	18.23	12.50	16.11	6	105431-2406	105431-2806	18.23	12.50	16.11	6								
105431-1407	105431-1807	20.73	15.00	18.61	7	105431-2407	105431-2807	20.73	15.00	18.61	7								
105431-1408	105431-1808	23.23	17.50	21.11	8	105431-2408	105431-2808	23.23	17.50	21.11	8								

COLOR: BLACK

COLOR: NATURAL

NOTES FOR ALL PARTS









1> MATERIAL:  
HOUSING: LCP, UL 94V-0.  
TERMINAL: BRASS.  
SOLDER CLIP: BRASS.

2> PLATING FINISHED:  
TERMINAL:  
CONTACT AREA:  
a. REFLOWED MATTE TIN 0.76 MICRONS MIN; b. GOLD 0.38 MICRONS MIN; c. GOLD 0.76 MICRONS MIN.  
SOLDER AREA: TIN 0.76 MICRONS MINIMUM.  
UNDER PLATING NICKEL 1.25 MICRONS MINIMUM.  
SOLDER CLIP: TIN 2.5 MICRONS MINIMUM; UNDER PLATING NICKEL 1.25 MICRONS MINIMUM.

3> PRODUCT SPECIFICATION: PS-105405-001.  
4> PACKAGE: TAPE REEL, DETAILS REFER TO DRAWING 1054311000-PK.  
5> ALL COMPONENTS AND PRODUCT COMPLIANT TO RoHS DIRECTIVE 2011/65/EU AND ELV DIRECTIVE 2000/53/EC.  
6> PRODUCT MATE WITH SERIES OF 105307(RECEPTACLE), 105300(CRIMP TERMINAL).  
7> PARTS CONFORM TO CLASS 'B' REQUIREMENTS OF COSMETIC SPECIFICATION PS-45499-002.

<b>QUALITY SYMBOLS</b> 	THIS DRAWING CONTAINS INFORMATION THAT IS PROPRIETARY TO MOLEX ELECTRONIC TECHNOLOGIES, LLC AND SHOULD NOT BE USED WITHOUT WRITTEN PERMISSION										
	EC NO: 670810 DRWN: GLLI CHK'D: YXZHENG APPR: YXZHENG	<b>GENERAL TOLERANCES (UNLESS SPECIFIED)</b> ANGULAR TOL ± 3.0 ° 4 PLACES ± 3 PLACES ± 2 PLACES ± 0.2 1 PLACE ± 0.3 0 PLACES ±		DIMENSION UNITS <b>mm</b>	SCALE <b>5:1</b>	 SD DRAWING FOR NANO-FIT HEADER OF SMT VERTICAL SINGLE CONN.					
		DRWN BY: <b>WJHUO</b> DATE: <b>2014/10/30</b> CHK'D BY: _____      DATE: _____		APPR BY: <b>AYIN</b> DATE: <b>2015/03/12</b>							
		DRAFT WHERE APPLICABLE MUST REMAIN WITHIN DIMENSIONS				SERIES: <b>105431</b> MATERIAL NUMBER: <b>SEE TABLE</b> CUSTOMER: <b>GENERAL MARKET</b>					
RELEASE STATUS: <b>P1</b> RELEASE DATE: <b>2021/07/22 09:31:37</b>				DOCUMENT NUMBER: <b>SD-105431-001</b> DOC TYPE: <b>PSD</b> DOC PART: <b>000</b> SHEET NUMBER: <b>3 OF 4</b>							

	2 CKT	3 CKT	4 CKT	5 CKT
BLACK				
NATURAL				
	6 CKT	7 CKT		8 CKT
BLACK				
NATURAL				

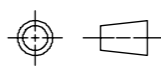
THIS DRAWING CONTAINS INFORMATION THAT IS PROPRIETARY TO MOLEX ELECTRONIC TECHNOLOGIES, LLC AND SHOULD NOT BE USED WITHOUT WRITTEN PERMISSION										
<b>QUALITY SYMBOLS</b>  = 0  = 0  = 0  = 0  = 0  = 0  = 0  = 0	2021/04/27 2021/07/22 2021/07/22	<b>GENERAL TOLERANCES (UNLESS SPECIFIED)</b> ANGULAR TOL ± 3.0 ° 4 PLACES ± 3 PLACES ± 2 PLACES ± 0.2 1 PLACE ± 0.3 0 PLACES ±		DIMENSION UNITS <b>mm</b>	SCALE <b>3:1</b>	  SD DRAWING FOR NANO-FIT HEADER OF SMT VERTICAL SINGLE CONN.				
	EC NO: 670810 DRWN: GLLI CHK'D: YXZHENG APPR: YXZHENG	DRAFT WHERE APPLICABLE MUST REMAIN WITHIN DIMENSIONS	DRWN BY <b>RMV02</b>	DATE <b>2016/01/14</b>	CHK'D BY _____					DATE _____
			4 PLACES ± 3 PLACES ± 2 PLACES ± 0.2 1 PLACE ± 0.3 0 PLACES ±	APPR BY <b>AYIN</b>	DATE <b>2017/05/15</b>	DRAWING SIZE <b>A3</b>	THIRD ANGLE PROJECTION 	SERIES <b>105431</b>	MATERIAL NUMBER _____	CUSTOMER <b>GENERAL MARKET</b>
				DOCUMENT NUMBER <b>SD-105431-001</b>	DOC TYPE <b>PSD</b>	DOC PART <b>000</b>	SHEET NUMBER <b>4 OF 4</b>			