

NOTES:

- MATERIALS:**
HOUSING: 30% GLASS FILLED NYLON 4/6, U.L. 94V-0, COLOR: BLACK.
TERMINAL: ALLOY 151 PLATING: TIN-LEAD OVER NICKEL.
- PRODUCT SPEC.:** PSX-42815-0001
- ALL DIMENSIONS SHOWN FOR REFERENCE ONLY.
- USES STANDARD 42874 MINI-FIT SR. HEADER TERMINALS.
- PART MATES WITH MOLEX RECEPTACLE 43914.
- RETENTION CLIP & LOCATING PIN PCB HOLES ARE NPTH

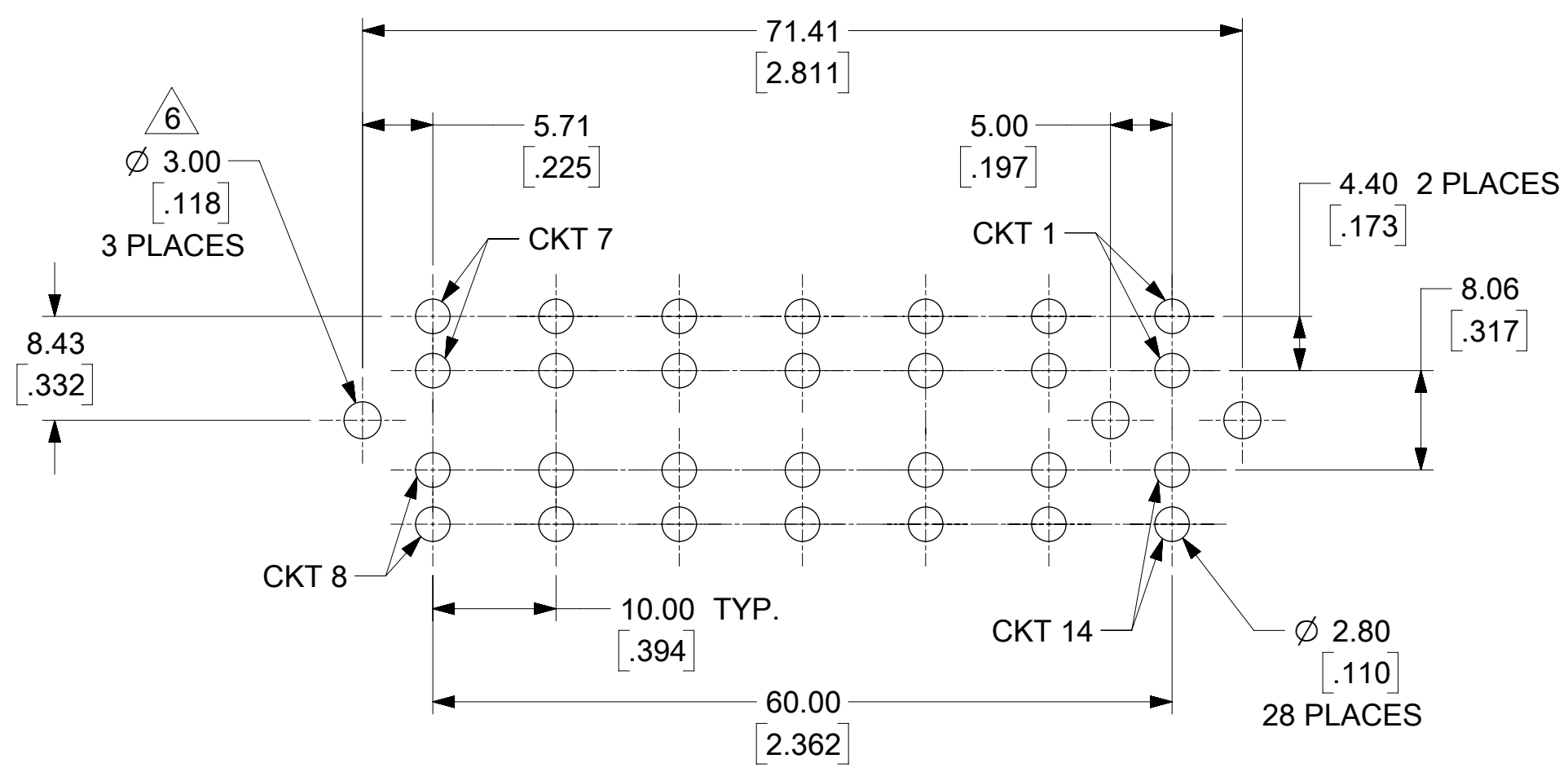

RECOMMENDED P.C. BOARD PLATED-THRU HOLE LAYOUT
(RECOMMENDED PCB THICKNESS : 1.57mm)

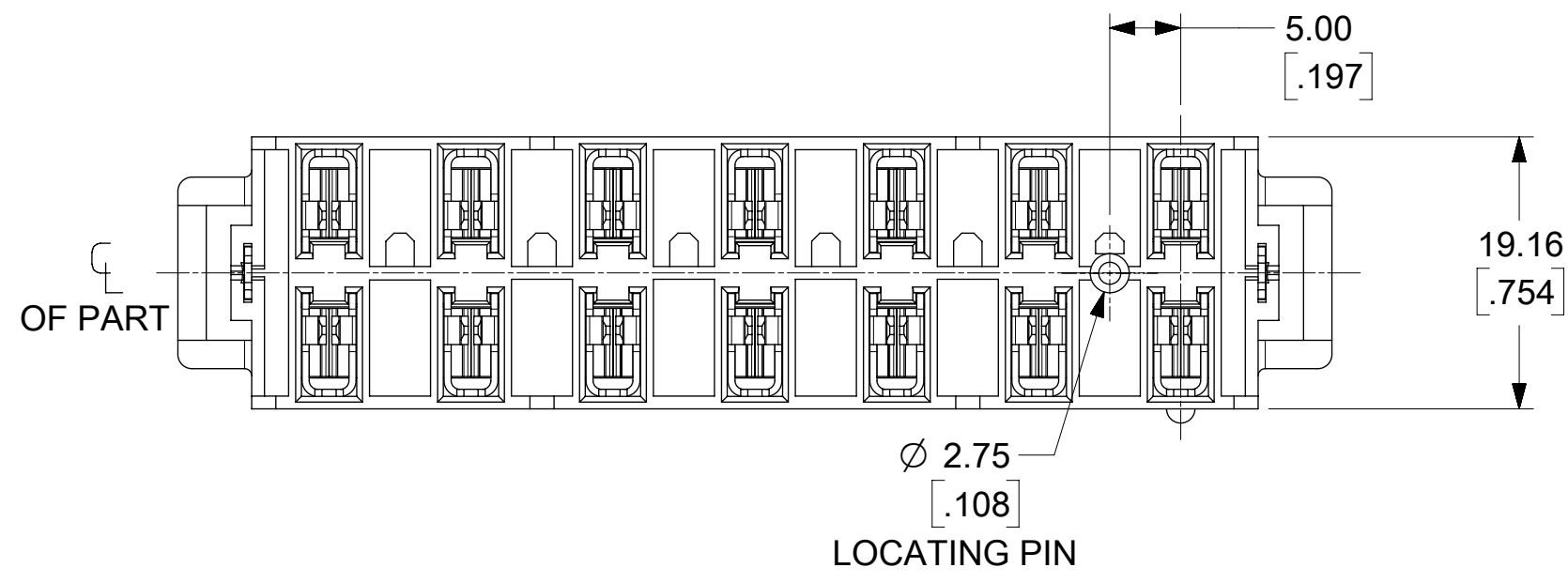
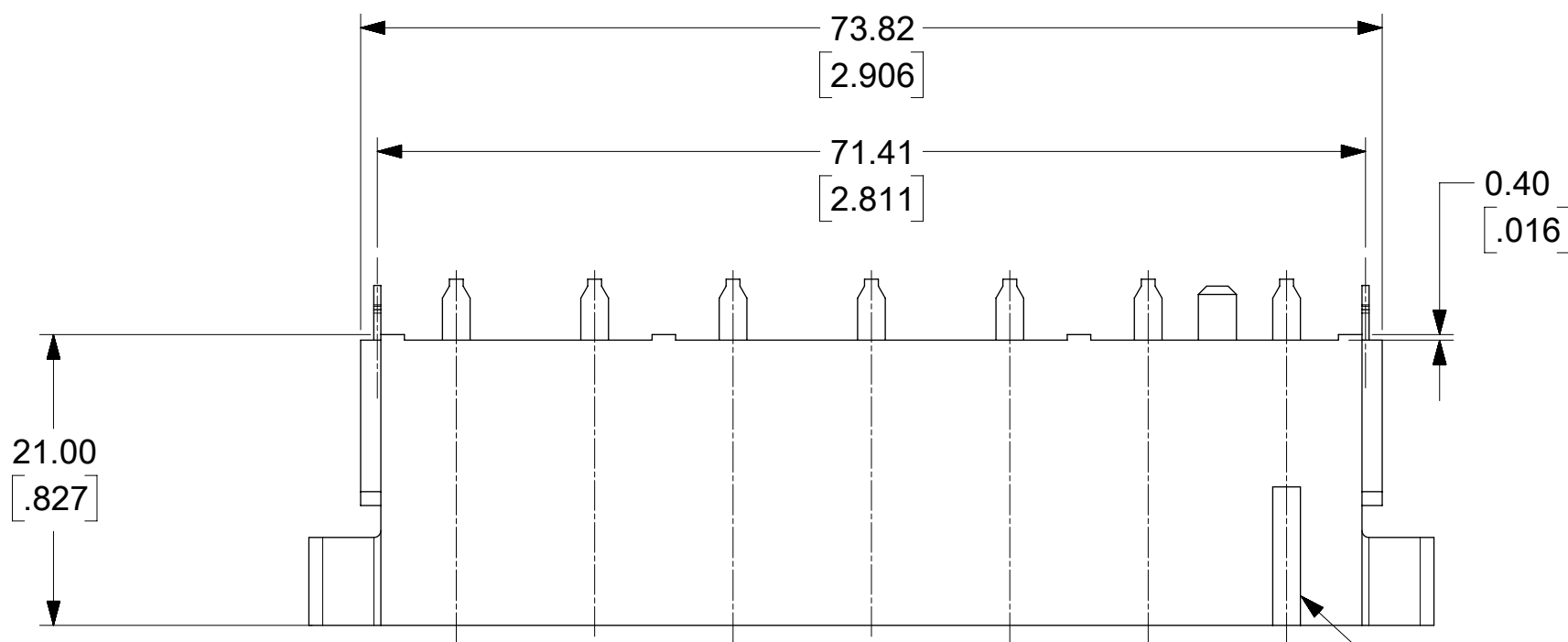

CIRCUIT #1 DESIGNATION

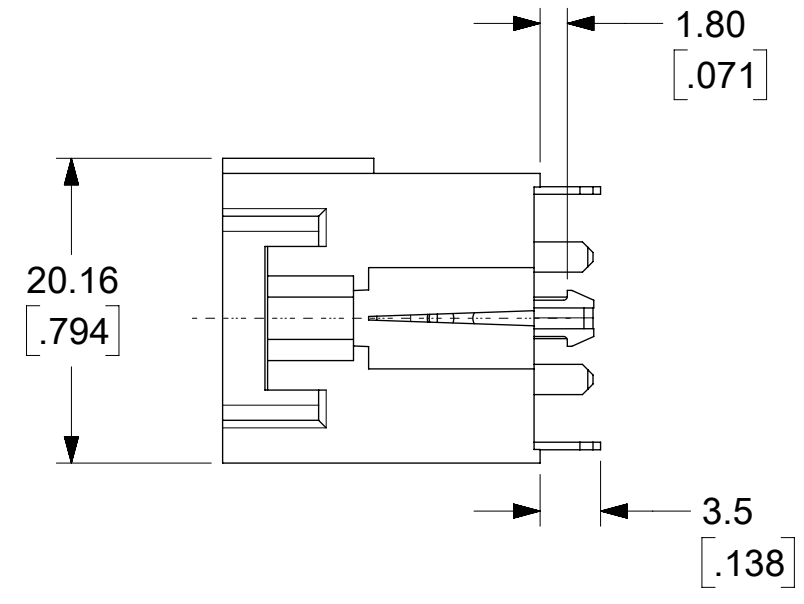
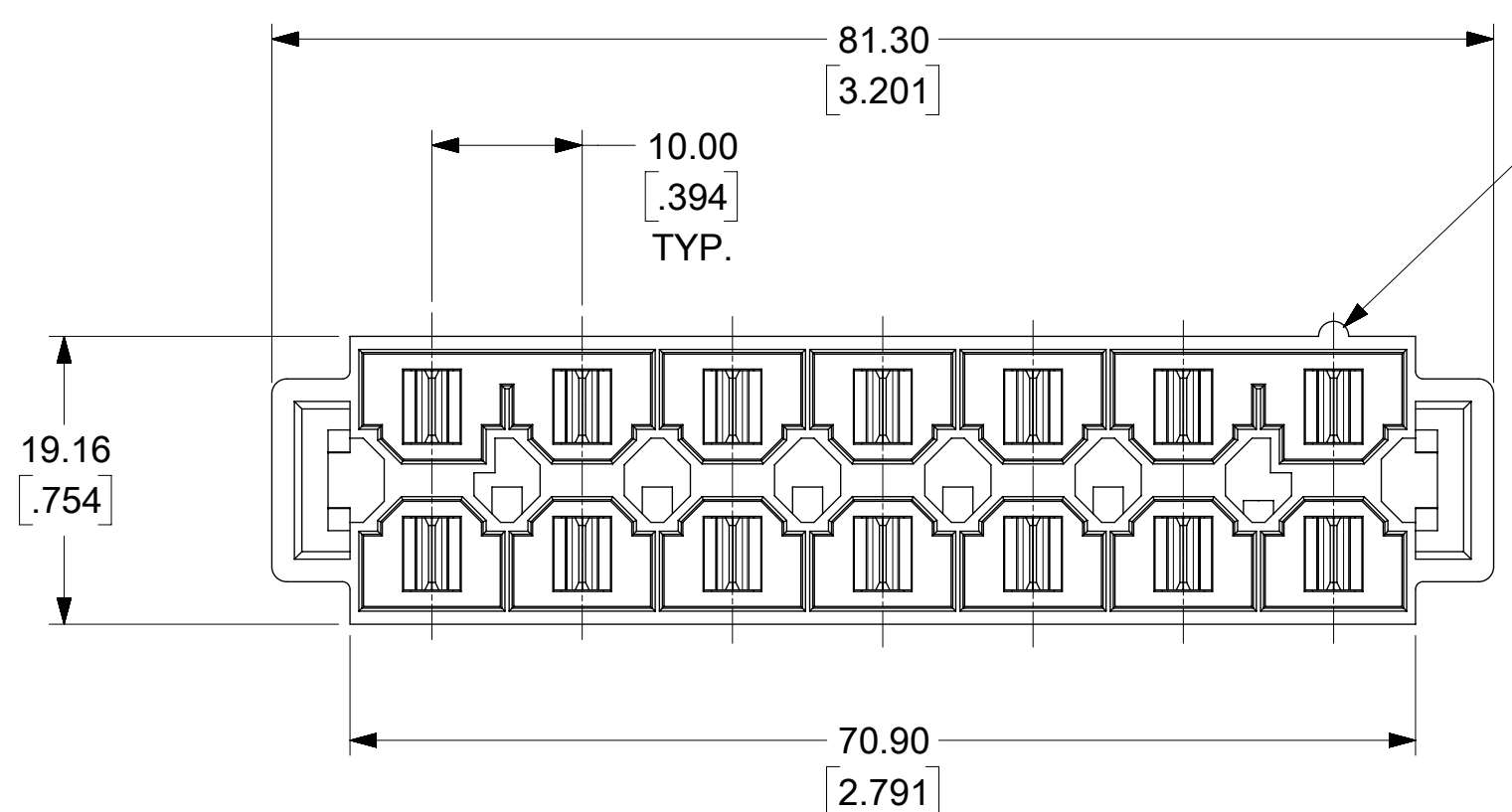

PROPOSAL

THIS DRAWING CONTAINS INFORMATION THAT IS PROPRIETARY TO MOLEX ELECTRONIC TECHNOLOGIES, LLC AND SHOULD NOT BE USED WITHOUT WRITTEN PERMISSION									
DIMENSION UNITS MM / INCH		SCALE 2:1		CURRENT REV DESC: MIGRATED TO ECTR					
GENERAL TOLERANCES (UNLESS SPECIFIED)				EC NO: 631364		DRWN: PKH		2020/01/28	
4 PLACES ±		±		CHK'D: ISHWARG		2020/02/21		APPR: ISHWARG	
3 PLACES ±		±		INITIAL REVISION:		DRWN: COMERCI		1997/05/08	
2 PLACES ±		0.1 ±		APPR: FRY		1997/05/12		SERIES	
1 PLACE ±		0.25 ±		THIRD ANGLE PROJECTION		DRAWING		C-SIZE	
0 PLACES ±		±		DRAFT WHERE APPLICABLE MUST REMAIN WITHIN DIMENSIONS		SERIES		43915	
ANGULAR TOL ±		0.5 °		MATERIAL NUMBER		CUSTOMER		SHEET NUMBER	
DOCUMENT NUMBER		SD-43915-001		DOC TYPE		PSD		DOC PART	
DOC PART		001		REVISION		A4		GENERAL MARKET	
CUSTOMER		GENERAL MARKET		SHEET NUMBER		1 OF 1		1	

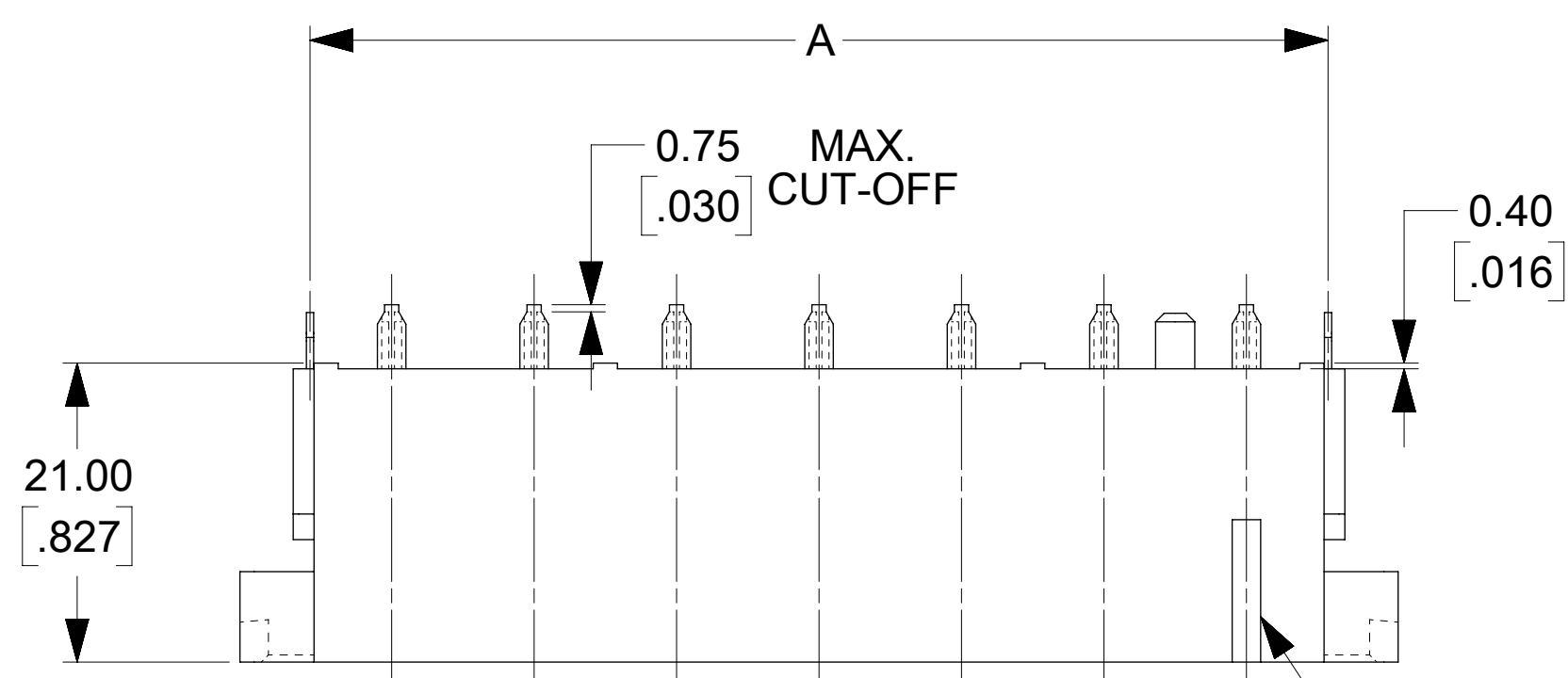
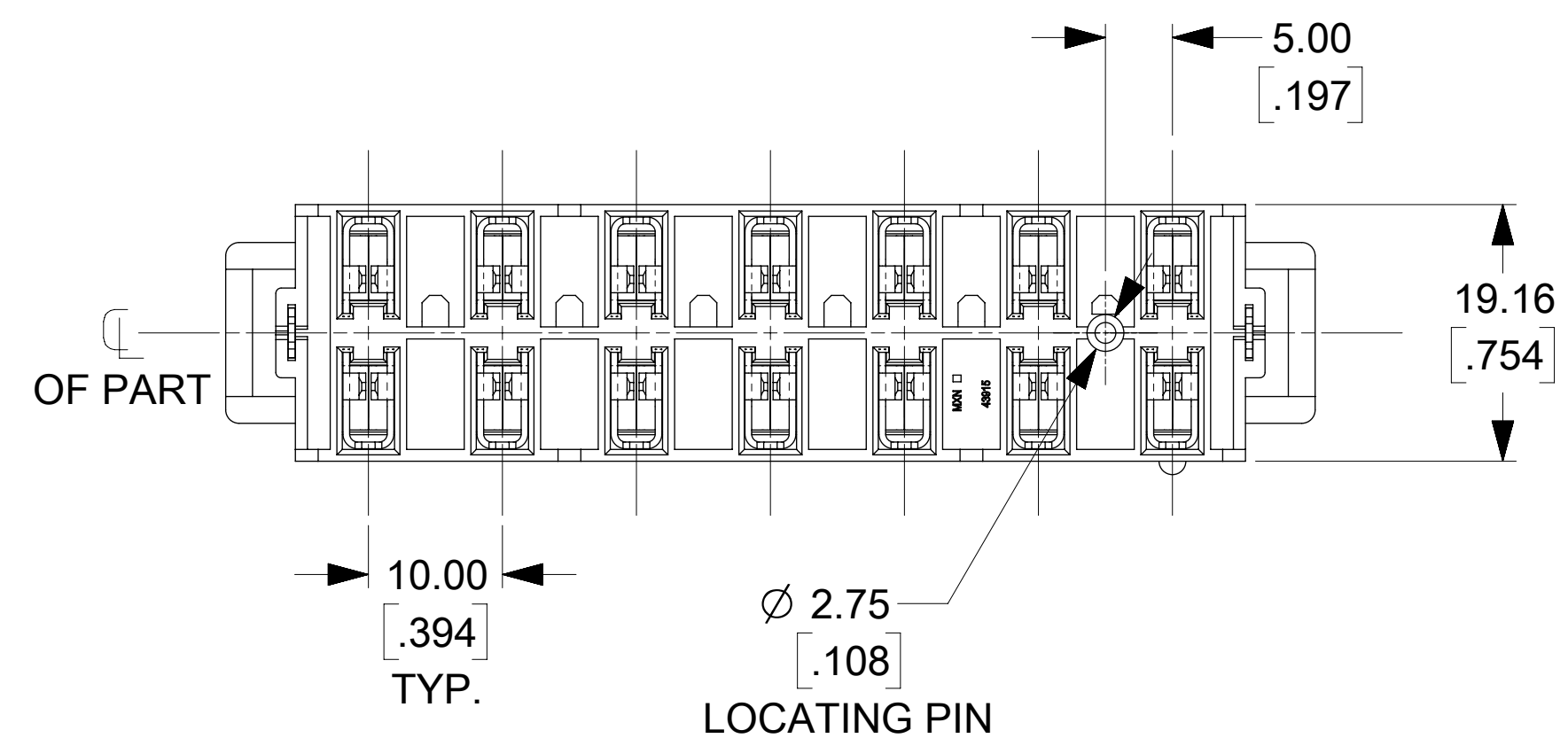

LEGEND:
439151***

PLATING:
1 OR 9 = TIN PLATING
2 = SELECT GOLD AND SELECT TIN OVER NICKEL
4 = SELECT SILVER AND SELECT TIN OVER NICKEL

POLARIZING SLOTS (2 PLACES)
(SEE CHART AND SEE NOTE 6)

MATING AREA
(SEE NOTE 5)

CIRCUIT #1 DESIGNATION

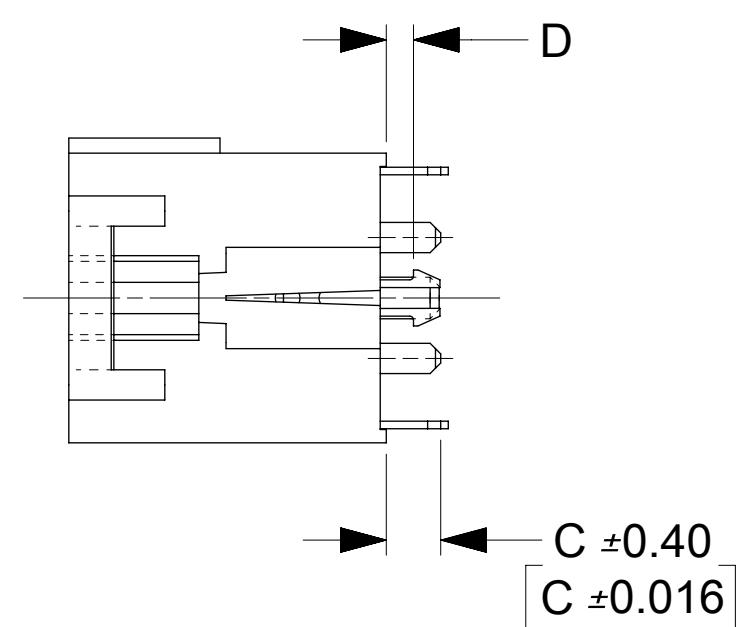
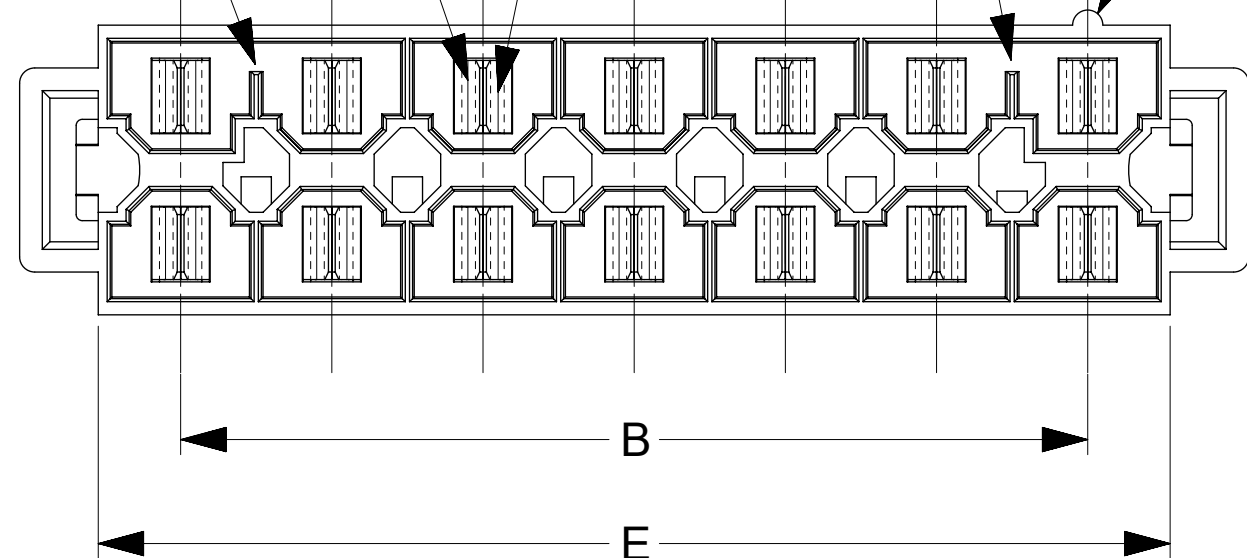

NOTES:

- MATERIALS:
HOUSING: 30% GLASS FILLED NYLON 4/6, U.L.94V-0, COLOR: BLACK.
TERMINAL: ALLOY 151
PLATING: *TIN OVER NICKEL.
OR SELECT GOLD AND SELECT TIN OVER NICKEL
OR SELECT SILVER AND SELECT TIN OVER NICKEL
(SEE CHART)
* THE PRIMARY SHIPPING CARTON WILL BE LABELED 'COMPLAINT TO RoHS DIRECTIVE 2002/95/EC AND ELV ANNEX II OF DIRECTIVE 2000/53/EC'. CARTONS WITHOUT THIS LABEL MAY CONTAIN PRODUCT WITH TIN-LEAD.
- PRODUCT SPEC.: PS-42815-0001
- PARTS ARE NOT TO BE MATED OR UNMATED WHILE CIRCUITS ARE LIVE.
- PART MATES WITH MOLEX RECEPTACLE 43914.
- WHEN USING OVERALL TIN PLATED TERMINALS:
FOR APPLICATIONS INVOLVING VIBRATION AND/OR THERMAL CYCLING, MOLEX STRONGLY RECOMMENDS THE USE OF NYE LUBRICANT (NYOGEL 760G) ON THE MATING SURFACES OF THE TERMINAL.
- POLARIZING SLOTS TO BE LOCATED BETWEEN CIRCUITS ON EITHER END OF HOUSING OF THE CIRCUIT 1 ROW. AS SHOWN.
EXCEPTION: THE 6 CIRCUIT HOUSING WILL HAVE A SINGLE SLOT ON THE CIRCUIT 1 END ONLY.
- PARTS CONFORMS TO CLASS 'B' REQUIREMENTS OF COSMETIC SPEC-PS-45499-002.
- REFER AS-42815-001 FOR TIN PLATED TERMINALS RECOMMENDED LUBRICATION PROCEDURE.

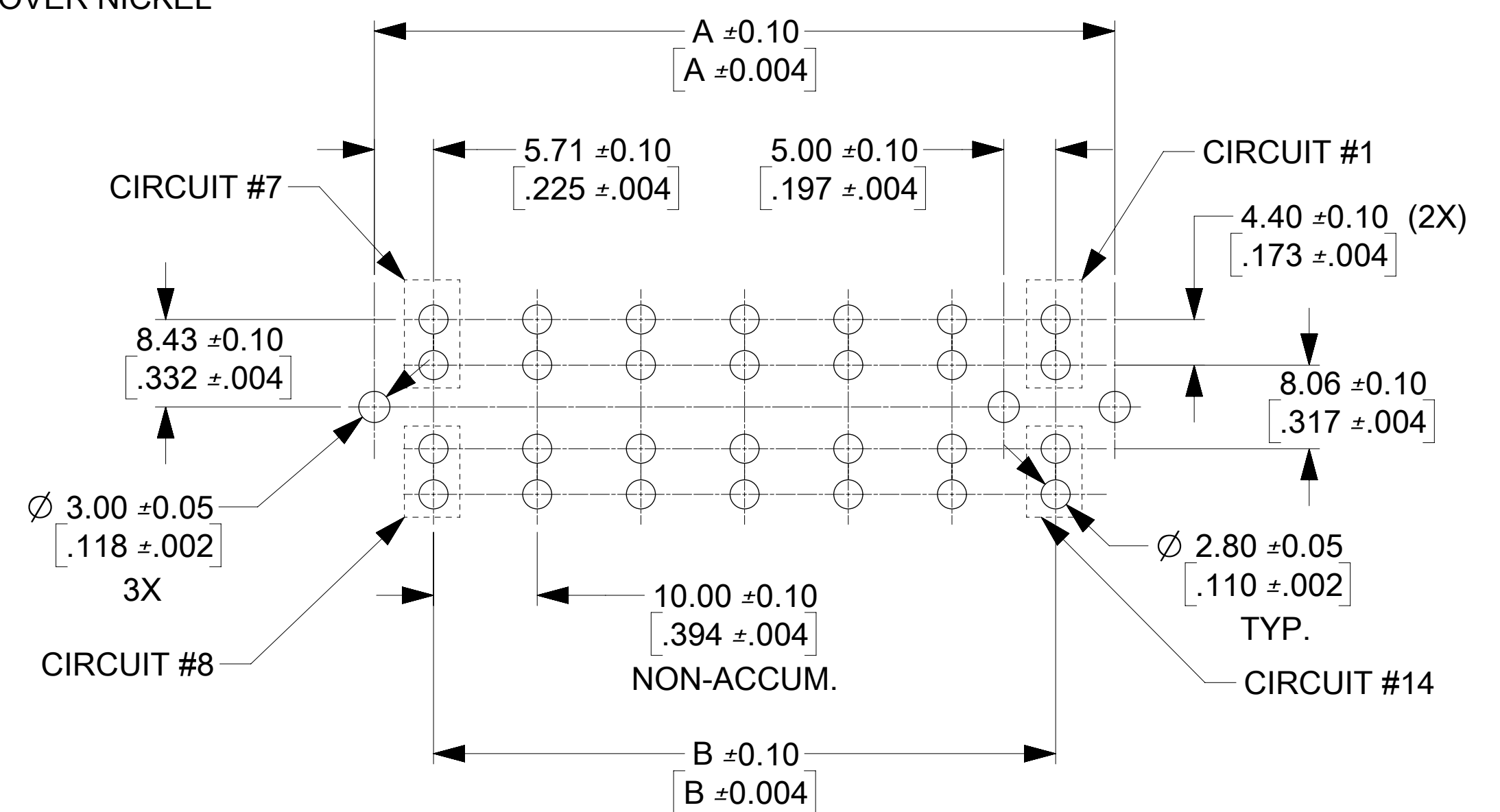

RECOMMENDED P.C. BOARD PLATED-THRU HOLE LAYOUT
(14 CIRCUIT LAYOUT SHOWN)

THIS DRAWING CONTAINS INFORMATION THAT IS PROPRIETARY TO MOLEX ELECTRONIC TECHNOLOGIES, LLC AND SHOULD NOT BE USED WITHOUT WRITTEN PERMISSION											
DIMENSION UNITS		SCALE		CURRENT REV DESC: MIGRATED TO ECTR							
MM/IN		2:1		molex VERTICAL HEADER DUAL ROW, 6-14 CIRCUIT MINI-FIT SR. PRODUCT CUSTOMER DRAWING							
GENERAL TOLERANCES (UNLESS SPECIFIED)											
	MM	INCH									
4 PLACES ±											
3 PLACES ±		± 0.008									
2 PLACES ±	0.2			EC NO: 611033	2018/11/14			DOCUMENT NUMBER: SD-43915-002 DOC TYPE: PSD DOC PART: 001 REVISION: F			
1 PLACE ±				DRWN: ME	2019/01/25						
0 PLACES ±				CHK'D: MKAMATHMARAK	2019/02/08			MATERIAL NUMBER: SEE CHART CUSTOMER: GENERAL MARKET SHEET NUMBER: 1 OF 2			
ANGULAR TOL ±	0.5°			APPR: ISHWARG	2019/02/08						
DRAFT WHERE APPLICABLE MUST REMAIN WITHIN DIMENSIONS				THIRD ANGLE PROJECTION		DRAWING		SERIES			
				D-SIZE		43915					

MATERIAL NUMBER	CIRCUITS	DIM .A	DIM. B	DIM. C	DIM. D	DIM. E	PCB THICKNESS	QUANTITY OF POLARIZING SLOTS	TERMINAL PLATING	STATUS
L 439151201	6	31.41/[1.237]	20.00/[.787]	3.50/[.137]	1.80/[.071]	30.90/[1.217]	1.57/[.062]	1	SELECT GOLD (SEE LEGEND)	ACTIVE
439151202	8	41.41/[1.630]	30.00/[1.181]	3.50/[.137]	1.80/[.071]	40.90/[1.610]		2		
439151203	10	51.41/[2.024]	40.00/[1.575]	3.50/[.137]	1.80/[.071]	50.90/[2.004]		2		
439151204	12	61.41/[2.418]	50.00/[1.969]	3.50/[.137]	1.80/[.071]	60.90/[2.398]		2		
K 439151205	14	71.41/[2.811]	60.00/[2.362]	3.50/[.137]	1.80/[.071]	70.90/[2.791]	2.36/[.093]	2		
439151206	6	31.41/[1.237]	20.00/[.787]	5.10/[.201]	2.60/[.102]	30.90/[1.217]		1		
439151207	8	41.41/[1.630]	30.00/[1.181]	5.10/[.201]	2.60/[.102]	40.90/[1.610]		2		
439151208	10	51.41/[2.024]	40.00/[1.575]	5.10/[.201]	2.60/[.102]	50.90/[2.004]		2		
J 439151209	12	61.41/[2.418]	50.00/[1.969]	5.10/[.201]	2.60/[.102]	60.90/[2.398]	3.18/[.125]	2		
439151210	14	71.41/[2.811]	60.00/[2.362]	5.10/[.201]	2.60/[.102]	70.90/[2.791]		2		
439151211	6	31.41/[1.237]	20.00/[.787]	5.10/[.201]	3.40/[.134]	30.90/[1.217]		1		
439151212	8	41.41/[1.630]	30.00/[1.181]	5.10/[.201]	3.40/[.134]	40.90/[1.610]		2		
H 439151213	10	51.41/[2.024]	40.00/[1.575]	5.10/[.201]	3.40/[.134]	50.90/[2.004]	6.35/[.250]	2		
439151214	12	61.41/[2.418]	50.00/[1.969]	5.10/[.201]	3.40/[.134]	60.90/[2.398]		2		
439151215	14	71.41/[2.811]	60.00/[2.362]	5.10/[.201]	3.40/[.134]	70.90/[2.791]		2		
439151216	6	31.41/[1.237]	20.00/[.787]	8.30/[.327]	6.58/[.259]	30.90/[1.217]		1		
G 439151217	8	41.41/[1.630]	30.00/[1.181]	8.30/[.327]	6.58/[.259]	40.90/[1.610]	2.36/[.093]	2		
439151218	10	51.41/[2.024]	40.00/[1.575]	8.30/[.327]	6.58/[.259]	50.90/[2.004]		2		
439151219	12	61.41/[2.418]	50.00/[1.969]	8.30/[.327]	6.58/[.259]	60.90/[2.398]		2		
439151220	14	71.41/[2.811]	60.00/[2.362]	8.30/[.327]	6.58/[.259]	70.90/[2.791]		2		
F 439151221	10	51.41/[2.024]	40.00/[1.575]	3.50/[.137]	2.60/[.102]	50.90/[2.004]	1.57/[.062]	2		
H 439151401	6	31.41/[1.237]	20.00/[.787]	3.50/[.137]	1.80/[.071]	30.90/[1.217]		1		
439151402	8	41.41/[1.630]	30.00/[1.181]	3.50/[.137]	1.80/[.071]	40.90/[1.610]		2		
439151403	10	51.41/[2.024]	40.00/[1.575]	3.50/[.137]	1.80/[.071]	50.90/[2.004]		2		
E 439151404	12	61.41/[2.418]	50.00/[1.969]	3.50/[.137]	1.80/[.071]	60.90/[2.398]	2.36/[.093]	2		
G 439151405	14	71.41/[2.811]	60.00/[2.362]	3.50/[.137]	1.80/[.071]	70.90/[2.791]		2		
439151406	6	31.41/[1.237]	20.00/[.787]	5.10/[.201]	2.60/[.102]	30.90/[1.217]		1		
439151407	8	41.41/[1.630]	30.00/[1.181]	5.10/[.201]	2.60/[.102]	40.90/[1.610]		2		
D 439151408	10	51.41/[2.024]	40.00/[1.575]	5.10/[.201]	2.60/[.102]	50.90/[2.004]	3.18/[.125]	2		
F 439151409	12	61.41/[2.418]	50.00/[1.969]	5.10/[.201]	2.60/[.102]	60.90/[2.398]		2		
439151410	14	71.41/[2.811]	60.00/[2.362]	5.10/[.201]	2.60/[.102]	70.90/[2.791]		2		
439151411	6	31.41/[1.237]	20.00/[.787]	5.10/[.201]	3.40/[.134]	30.90/[1.217]		1		
C 439151412	8	41.41/[1.630]	30.00/[1.181]	5.10/[.201]	3.40/[.134]	40.90/[1.610]	6.35/[.250]	2		
439151413	10	51.41/[2.024]	40.00/[1.575]	5.10/[.201]	3.40/[.134]	50.90/[2.004]		2		
439151414	12	61.41/[2.418]	50.00/[1.969]	5.10/[.201]	3.40/[.134]	60.90/[2.398]		2		
439151415	14	71.41/[2.811]	60.00/[2.362]	5.10/[.201]	3.40/[.134]	70.90/[2.791]		2		
B 439151416	6	31.41/[1.237]	20.00/[.787]	8.30/[.327]	6.58/[.259]	30.90/[1.217]	2.36/[.093]	1		
439151417	8	41.41/[1.630]	30.00/[1.181]	8.30/[.327]	6.58/[.259]	40.90/[1.610]		2		
439151418	10	51.41/[2.024]	40.00/[1.575]	8.30/[.327]	6.58/[.259]	50.90/[2.004]		2		
439151419	12	61.41/[2.418]	50.00/[1.969]	8.30/[.327]	6.58/[.259]	60.90/[2.398]		2		
A 439151420	14	71.41/[2.811]	60.00/[2.362]	8.30/[.327]	6.58/[.259]	70.90/[2.791]	1.57/[.062]	2		
E 439151421	10	51.41/[2.024]	40.00/[1.575]	3.50/[.137]	2.60/[.102]	50.90/[2.004]		2		
439151101	6	31.41/[1.237]	20.00/[.787]	3.50/[.137]	1.80/[.071]	30.90/[1.217]		1		
439151102	8	41.41/[1.630]	30.00/[1.181]	3.50/[.137]	1.80/[.071]	40.90/[1.610]		2		
D 439151103	10	51.41/[2.024]	40.00/[1.575]	3.50/[.137]	1.80/[.071]	50.90/[2.004]	2.36/[.093]	2		
439151104	12	61.41/[2.418]	50.00/[1.969]	3.50/[.137]	1.80/[.071]	60.90/[2.398]		2		
439151105	14	71.41/[2.811]	60.00/[2.362]	3.50/[.137]	1.80/[.071]	70.90/[2.791]		2		
439151106	6	31.41/[1.237]	20.00/[.787]	5.10/[.201]	2.60/[.102]	30.90/[1.217]		1		
C 439151107	8	41.41/[1.630]	30.00/[1.181]	5.10/[.201]	2.60/[.102]	40.90/[1.610]	3.18/[.125]	2		
439151108	10	51.41/[2.024]	40.00/[1.575]	5.10/[.201]	2.60/[.102]	50.90/[2.004]		2		
439151109	12	61.41/[2.418]	50.00/[1.969]	5.10/[.201]	2.60/[.102]	60.90/[2.398]		2		
439151110	14	71.41/[2.811]	60.00/[2.362]	5.10/[.201]	2.60/[.102]	70.90/[2.791]		2		
B 439151111	6	31.41/[1.237]	20.00/[.787]	5.10/[.201]	3.40/[.134]	30.90/[1.217]	6.35/[.250]	1		
439151112	8	41.41/[1.630]	30.00/[1.181]	5.10/[.201]	3.40/[.134]	40.90/[1.610]		2		
439151113	10	51.41/[2.024]	40.00/[1.575]	5.10/[.201]	3.40/[.134]	50.90/[2.004]		2		
439151114	12	61.41/[2.418]	50.00/[1.969]	5.10/[.201]	3.40/[.134]	60.90/[2.398]		2		
A 439151115	14	71.41/[2.811]	60.00/[2.362]	5.10/[.201]	3.40/[.134]	70.90/[2.791]	1.57/[.062]	2		
439151116	6	31.41/[1.237]	20.00/[.787]	8.30/[.327]	6.58/[.259]	30.90/[1.217]		1		
439151117	8	41.41/[1.630]	30.00/[1.181]	8.30/[.327]	6.58/[.259]	40.90/[1.610]		2		
439151118	10	51.41/[2.024]	40.00/[1.575]	8.30/[.327]	6.58/[.259]	50.90/[2.004]		2		
B 439151119	12	61.41/[2.418]	50.00/[1.969]	8.30/[.327]	6.58/[.259]	60.90/[2.398]	2.36/[.093]	2		
439151120	14	71.41/[2.811]	60.00/[2.362]	8.30/[.327]	6.58/[.259]	70.90/[2.791]		2		
439151121	10	51.41/[2.024]	40.00/[1.575]	3.50/[.137]	2.60/[.102]	50.90/[2.004]		2		
439151905	14	71.41/[2.811]	60.00/[2.362]	3.50/[.137]	1.80/[.071]	70.90/[2.791]		1.57/[.062]	2	

THIS DRAWING CONTAINS INFORMATION THAT IS PROPRIETARY TO MOLEX ELECTRONIC TECHNOLOGIES, LLC AND SHOULD NOT BE USED WITHOUT WRITTEN PERMISSION

DIMENSION UNITS		SCALE		CURRENT REV DESC: MIGRATED TO ECTR			
MM/IN		1:1		<p>molex</p> <p>VERTICAL HEADER DUAL ROW, 6-14 CIRCUIT MINI-FIT SR.</p>			
GENERAL TOLERANCES (UNLESS SPECIFIED)							
		MM	INCH				
4 PLACES	±		±				
3 PLACES	±		± 0.008	EC NO: 611033	DRWN: ME	2018/11/14	
2 PLACES	±	0.2	±	CHK'D: MKAMATHMARAK	2019/01/25	APPR: ISHWARG	
1 PLACE	±		±	INITIAL REVISION:			
0 PLACES	±		±	DRWN: COMERCI	1997/08/21	2009/02/09	
ANGULAR TOL		± 0.5 °		APPR: KPRASAD			
DRAFT WHERE APPLICABLE MUST REMAIN WITHIN DIMENSIONS		THIRD ANGLE PROJECTION		DRAWING	SERIES	MATERIAL NUMBER	
				D-SIZE	43915	SEE CHART	
				CUSTOMER	GENERAL MARKET		
						SHEET NUMBER	
						2 OF 2	