

PLEDxN Series

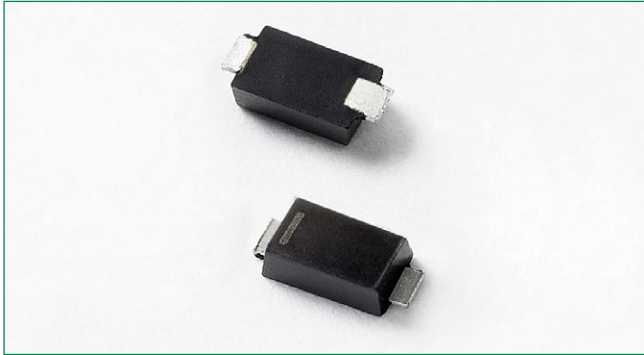

Description

The open LED protector provides a switching electronic shunt path when a single LED in an LED string fails as an open circuit. This ensures the entire LED string will continue to function even if a single LED in the string does not. This provides higher reliable lighting functions in applications such as headlights, aircraft lights, airport runway lighting, roadside warning lights, etc. This component is compatible with one watt rated LEDs with a nominal 350 mA current at 3V. The SOD-123FL package is one of the lowest height profiles (1.1 mm) packages offered in the industry.

Pinout Diagram

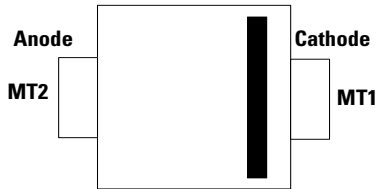

Features & Benefits

- Fast switching
- Automatically resets after power cycle
- Compatible with industrial standard package SOD-123FL
- Compatible with industrial lighting environments
- IEC 61000-4-2 ESD 30kV (Air), 30kV (Contact)
- ESD protection of data lines in accordance with IEC 61000-4-2
- Low profile: maximum height of 1.1mm
- RoHS compliant and halogen-free
- MSL: Level 1 - unlimited

Schematic Symbol

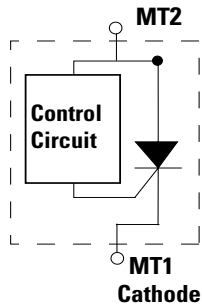

Electrical Characteristics (All parameters are measured at $T_A = 25^\circ\text{C}$ unless otherwise noted)

Part Number	Marking	V_{BR}		I_{LEAK}	I_H	I_S	$I_T @ V_T$	V_T	Critical rate of rise dV/dt	Capacitance @ 1MHz, 2V bias
		@ $I_{BR} = 1 \text{ mAmps}$		$V_{MT2} = 5V$				@ $I_T = 350\text{mA}$		
		Volts	Volts	μA	mA	mA	A	V		
PLED6N	P6N	Min	Max	Max	Max	Max	Max	Max	Max	Max
		5.5	7.5	250	12	70	1.0 ^{1,2}	1.2	250	24

Notes:

- 1) Standard FR-4 PCB with Copper Pads (2mm x 2mm/pad)
- 2) Aluminum PCB Pads (2mm x 3mm/pad)

Thermal Considerations

Symbol	Parameter	Value	Unit
I_T	Average On-State Current, ($T_A = 25^\circ\text{C}$)	1.0 ^{1,2}	A
V_T	On-state Voltage ($T_A = 125^\circ\text{C}$)	1.0	V
P_D	Power Dissipation ($T_A = 25^\circ\text{C}$)	1.45 ¹	W
		1.50 ²	
T_J	Operating Junction Temperature Range	-65 to +150	$^\circ\text{C}$
T_S	Storage Temperature Range		$^\circ\text{C}$
$R_{\theta JL}$	Thermal Resistance: Junction to Lead	25 ¹	$^\circ\text{C/W}$
		20 ²	
$R_{\theta JA}$	Thermal Resistance: Junction to Ambient	80 ¹	$^\circ\text{C/W}$
		50 ²	

Notes:

- 1) Standard FR-4 PCB with Copper Pads (2mm x 2mm/pad)
- 2) Aluminum PCB Pads (2mm x 3mm/pad)

V-I Characteristics

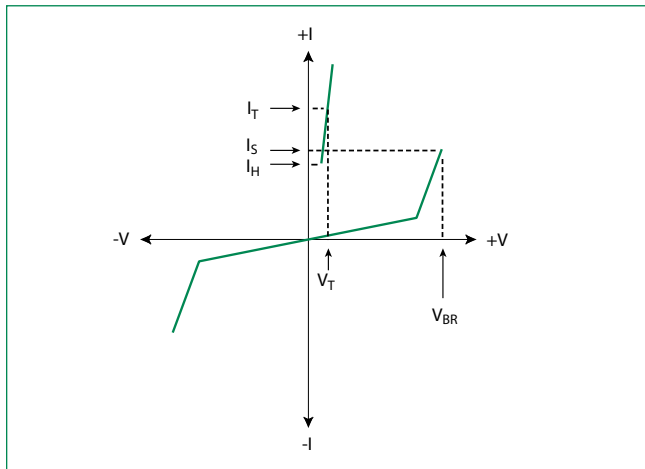

V_{BR} vs. Junction Temperature

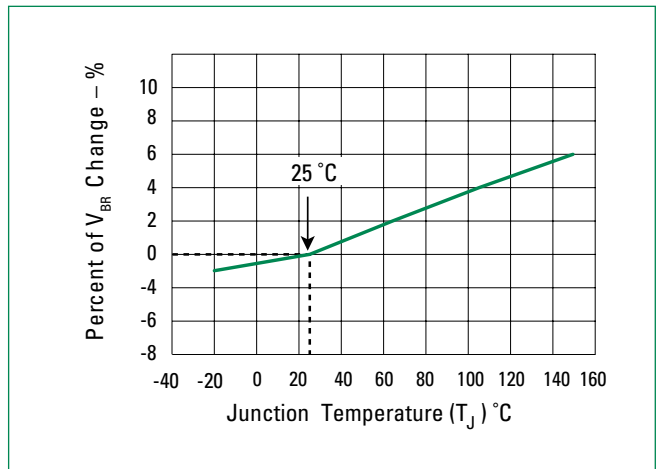

Normalized DC Holding Current vs. Ambient Temperature

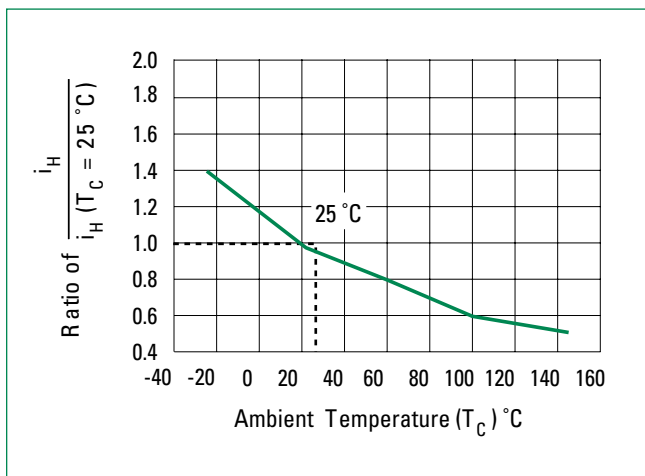

Capacitance vs Voltage

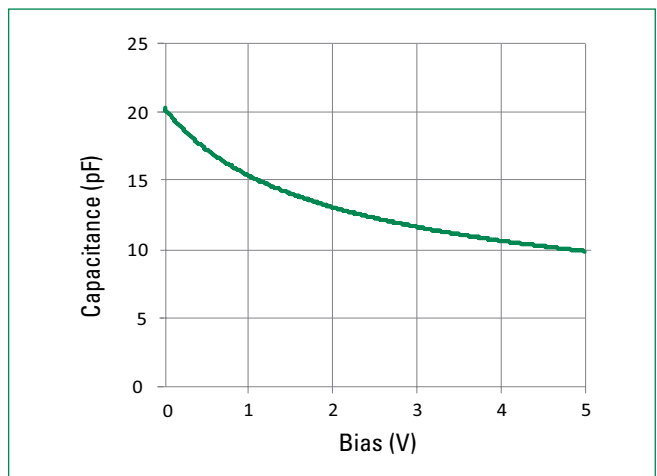

Leakage Current vs Temperature

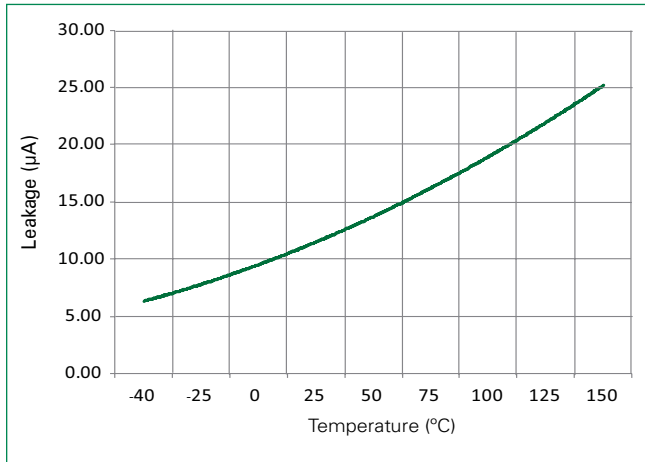

V_T vs I_T

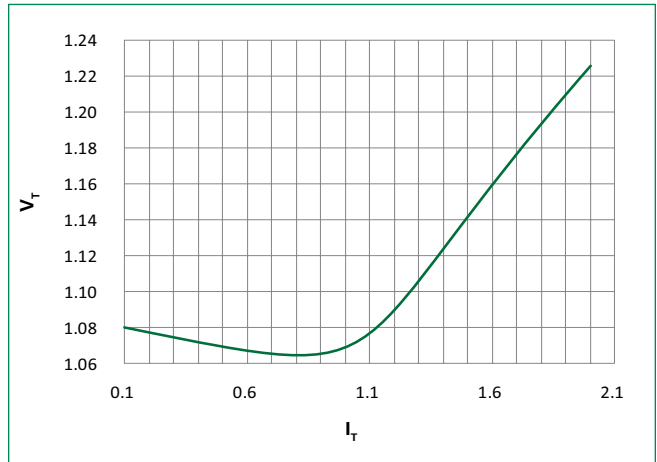

Operating Current vs. Ambient Temperature

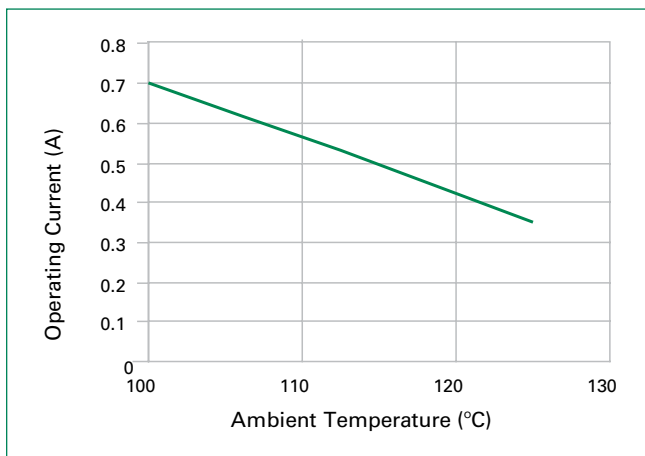

LED Interference Test Circuit

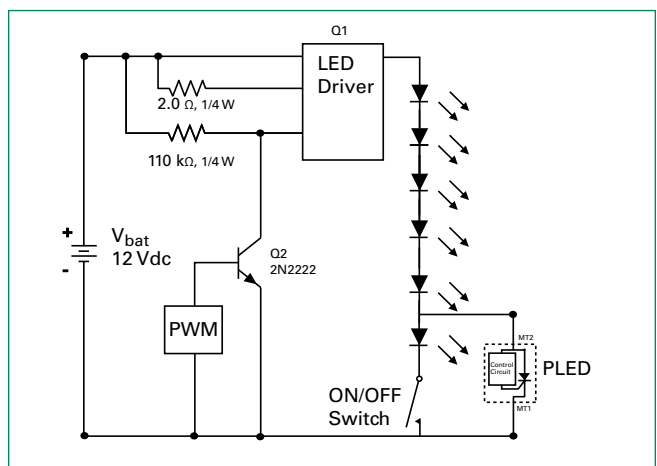

Typical Operation Waveforms

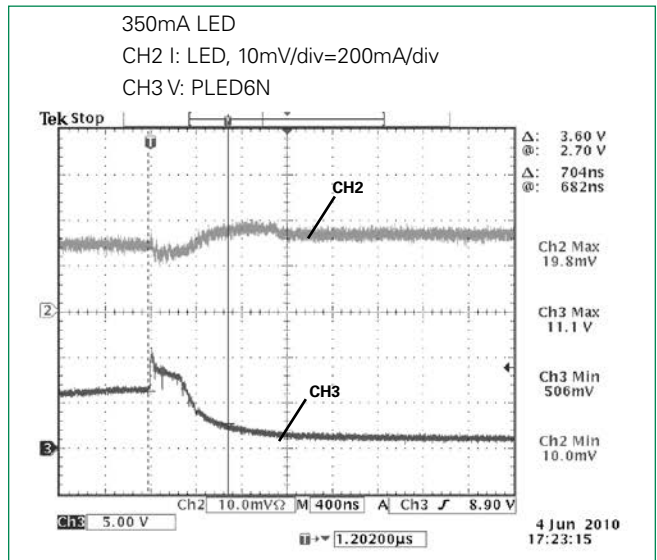
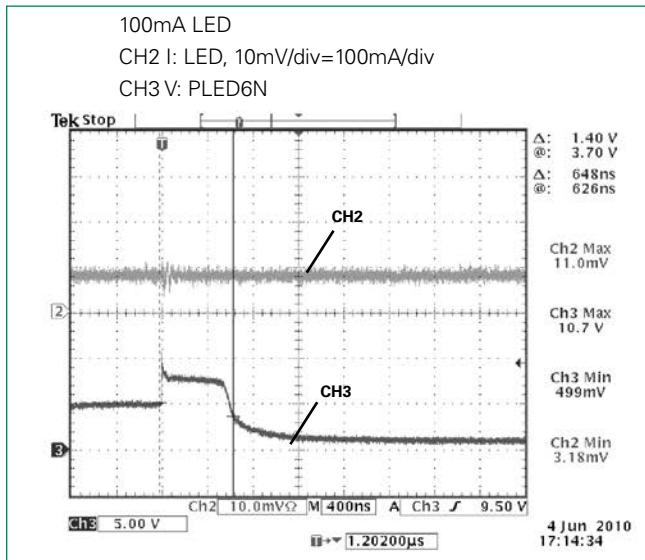

Soldering Parameters

Reflow Condition		Pb – Free assembly
Pre Heat	- Temperature Min ($T_{s(min)}$)	150°C
	- Temperature Max ($T_{s(max)}$)	200°C
	- Time (min to max) (t_s)	60 – 180 secs
Average ramp up rate (Liquidus Temp (T_L) to peak		3°C/second max
$T_{s(max)}$ to T_L - Ramp-up Rate		3°C/second max
Reflow	- Temperature (T_L) (Liquidus)	217°C
	- Temperature (t_L)	60 – 150 seconds
Peak Temperature (T_p)		260 ^{+0/-5} °C
Time within 5°C of actual peak Temperature (t_p)		30 seconds
Ramp-down Rate		6°C/second max
Time 25°C to peak Temperature (T_p)		8 minutes max
Do not exceed		260°C

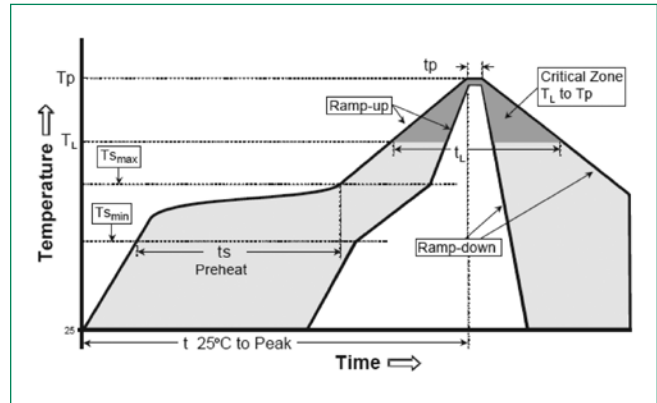

Physical Specifications

Terminal Material	Copper Alloy
Terminal Finish	100% Matte Tin Plated
Body Material	UL recognized epoxy meeting flammability classification V-0

Packaging

Package Code	Description	Packaging Quantity	Industry Standard
N	SOD-123FL	3000	EIA-481 Tape and Reel

Part Numbering System

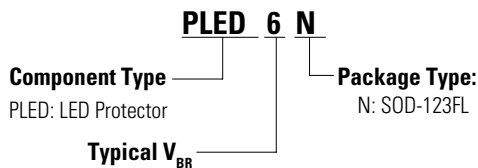

Environmental Specifications

High Temperature Voltage Blocking	MIL-STD-750: Method 1040, Condition A, 80% min V_{BR} DC, 150°C, 504 hours
Temperature Cycling	MIL-STD-750: Method 1051, -65°C to 150°C, 15-minute dwell, 100 cycles
Biased Temperature & Humidity	EIA/JEDEC: JESD22-A101, 80% min V_{BR} , 85°C, 85%RH, 1008 hours
Resistance to Solder Heat	MIL-STD-750: Method 2031, 260°C, 10 seconds
Moisture Sensitivity Level	JEDEC-J-STD-020, Level 1
Burn-In Test	$I_T = 0.350$ Adc, 1008 hours

Part Marking System

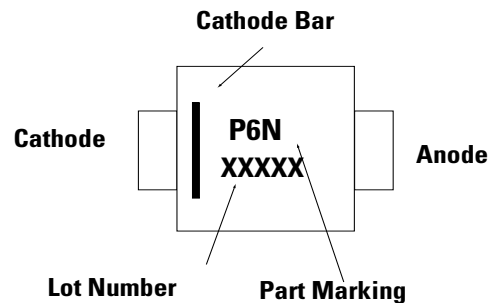

Dimensions - SOD-123FL Package

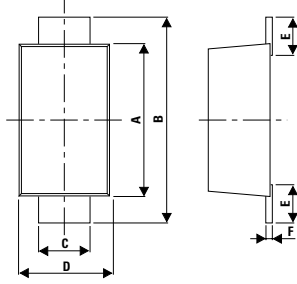

Dimensions	Millimeters		Inches	
	Min	Max	Min	Max
A	2.50	2.90	0.0984	0.1142
B	3.40	3.90	0.1339	0.1535
C	0.70	1.20	0.0275	0.0472
D	1.50	2.00	0.0591	0.0787
E	0.35	0.90	0.0138	0.0354
F	0.05	0.26	0.0020	0.0102
G	0.00	0.10	0.0000	0.0039
H	0.95	1.10	0.0374	0.0433

Mounting Pad Layout

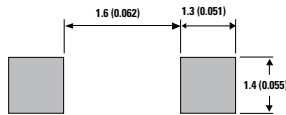

Tape and Reel Specification

