

DKSV274

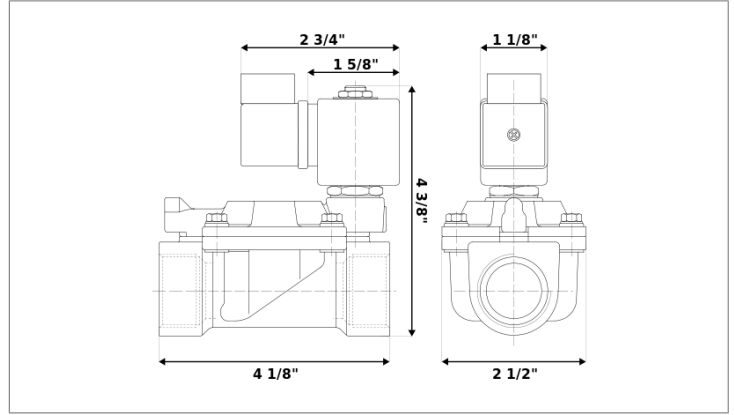

Normally closed, pilot operated, 2-way solenoid valve with low lead brass body and 1" connections



Valve	
Pipe size:	1" NPT
Operating pressure:	3–230 psi
Flow coefficient:	13 Cv
Media temperature:	15–180 °F
Ambient temperature:	-5–140 °F
Suggested usage:	Potable water
Operation:	2-way, normally closed solenoid valve
Mechanism:	Pilot operated
Manual override:	No
Pipe gender:	Female
Orifice size:	1"
Design pressure:	360 psi
Media viscosity:	12 cSt

Electrical	
Power:	120 V ac
Connection:	Conduit (1/2" NPT)
Holding:	15 VA
Inrush:	25 VA
Voltage tolerances:	+10% -15%
Coil inner diameter:	1/2"
Coil molding:	Polyethylene (PET)
Coil rating:	-5–355 °F (Class H)
Duty cycle:	Continuous, 100% ED
Enclosure:	NEMA 4, IP65

Materials	
Body:	Low lead brass
Seal:	EPDM rubber (EPDM)
Orifice:	Low lead brass
Core tube:	Stainless steel 300
Fixed core:	Stainless steel 400
Plunger:	Stainless steel 400
Spring:	Stainless steel 300
Shading ring:	Copper

Spare parts		
CORE TUBE	REPAIR KIT	COIL/CONNECTOR
AT-N0E1	RK-W0E2-02	C-B11
		
<ul style="list-style-type: none"> Core tube Plunger O-ring 	<ul style="list-style-type: none"> Diaphragm O-rings (2) Plunger 	<ul style="list-style-type: none"> 120 V ac electrical coil 1/2" conduit connector