

REVISIONS				
REV.	ECO. NO	DESCRIPTION	DATE	BY
D	3313	UPDATE DWG FORMAT, ADD 'A' MTG OPTION	10/12/2015	MG
E	4133	UPDATE NOTE 8 (WAS 3A), REMOVE CURRENT RATING IN P/N CODING, REMOVE 'N' ONLY FOR POSI 2,3,4, ADD POSITION 16 & 20 (# 12688)	10/24/2019	JH
F	4662	ADD S38, S81, S328	4/24/2023	MM

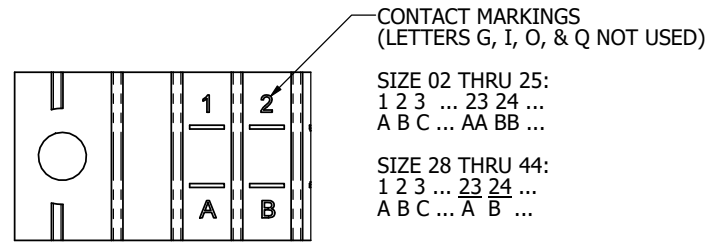

- NOTES:
- INSULATOR MATERIAL: SEE PART NUMBER CODING
 - CONTACT MATERIAL: SEE PART NUMBER CODING
 - PLATING: SEE PART NUMBER CODING
 - OPERATING TEMPERATURE: SEE PART NUMBER CODING
 - PROCESSING TEMP: SEE PART NUMBER CODING
 - UL FLAMMABILITY RATING: 94V-0
 - OPERATING VOLTAGE: 950 VAC
 - CURRENT RATING: 5 AMP
 - CONTACT RESISTANCE: 30 MILLI OHMS MAX
 - INSULATION RESISTANCE: 5000 MEGA OHMS
 - DURABILITY: 500 CYCLES MINIMUM
 - CONNECTOR IDENTIFICATION: THE PART SHALL BE MARKED WITH A PART NUMBER AND LOT CODE
 - BOARD THICKNESS ACCOMMODATED: $.062 \pm .008 [1.57 \pm 0.20]$
 - INSERTION FORCE: 16 OZ MAX PER CONTACT PAIR WHEN USING A $.062 [1.57]$ TEST BLADE
INTERNAL INSPECTION TO BE PER SULLINS WORK INSTRUCTION WI-8.6-03
 - WITHDRAWAL FORCE: 1 OZ MIN PER CONTACT PAIR USING $.062 [1.57]$ PCB
 - THREADED INSERT: ROTATIONAL TORQUE 4IN-LBS MAX.
 - MODIFICATION: SEE PART NUMBER CODING

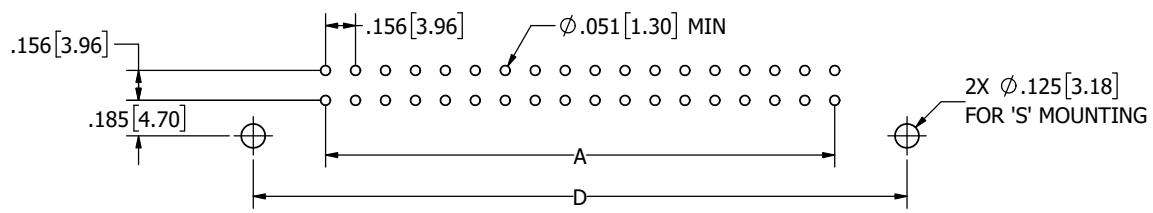
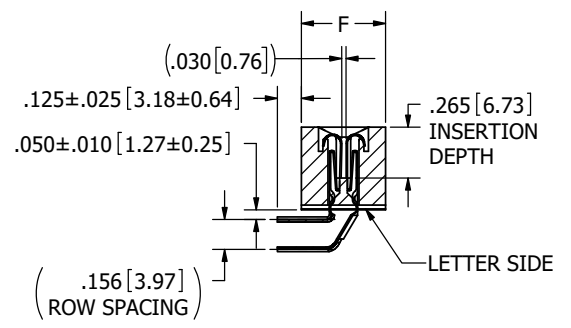
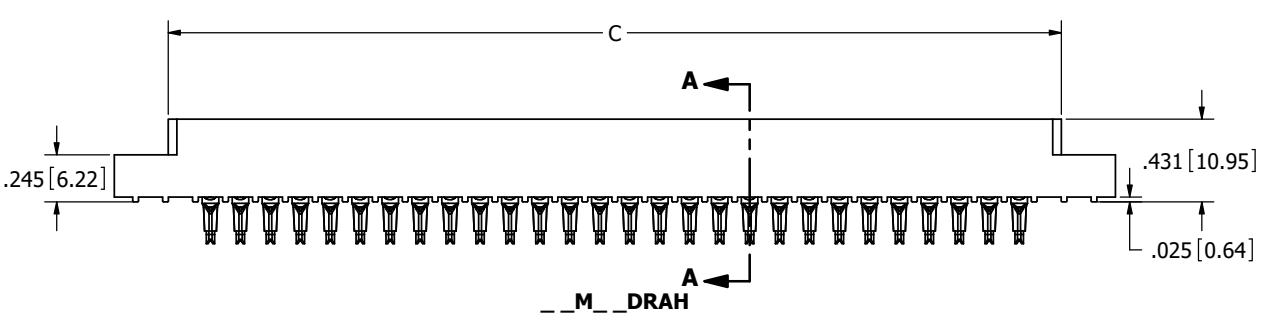
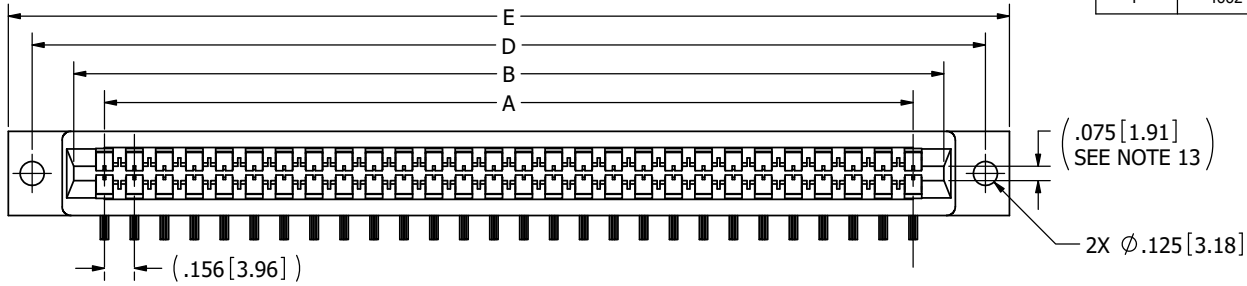

UNLESS OTHERWISE SPECIFIED: DIMENSIONS ARE IN INCHES (MM)		DRAWN	DATE	NAME	
TOLERANCES: ANGULAR: $\pm 1^\circ$ DECIMALS XX = $\pm .02 [5]$ XXX = $\pm .005 [13]$ XXXX = $\pm .0005 [013]$		11/14/2011	JH		
<small>THE INFORMATION HEREIN CONTAINS PROPRIETARY INFORMATION OF SULLINS ELECTRONICS AND IS NOT TO BE REPRODUCED, USED OR DISCLOSED TO OTHERS FOR ANY PURPOSE EXCEPT AS SPECIFICALLY AUTHORIZED IN WRITING BY AN OFFICER OF SULLINS ELECTRONICS.</small>					TITLE
					EDGE CARD, .156 CC, RAB
					PART NUMBER
					_ M _ DRA _ (-S38, S81, S328)
SIZE	CAGE CODE	DWG. NO.			REV
C	54453	C11126			F
SCALE: 2:1					SHEET 1 OF 3

CUSTOMER COPY

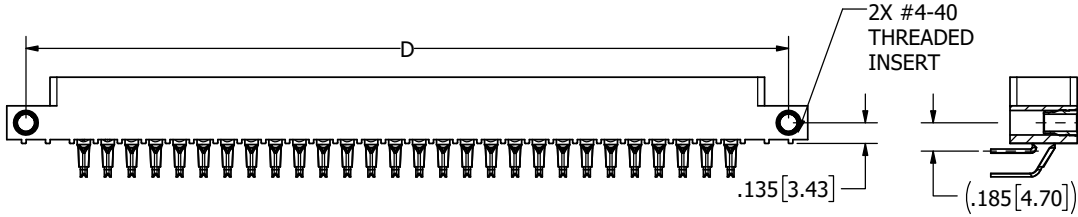
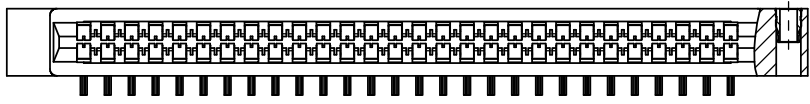

--M_DRAA

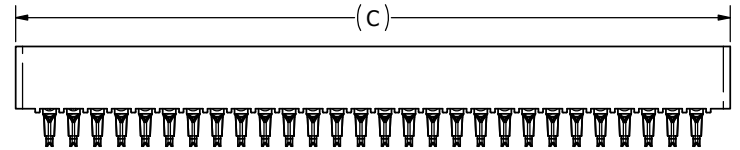
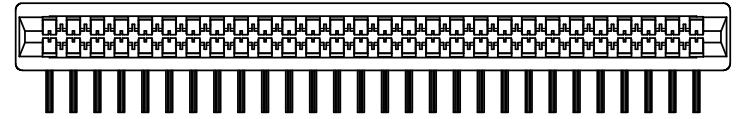

--M_DRAN

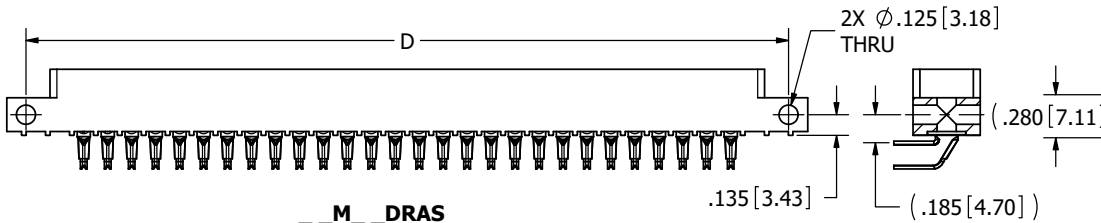
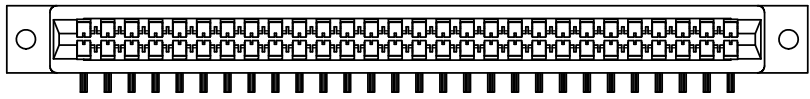

--M_DRAS

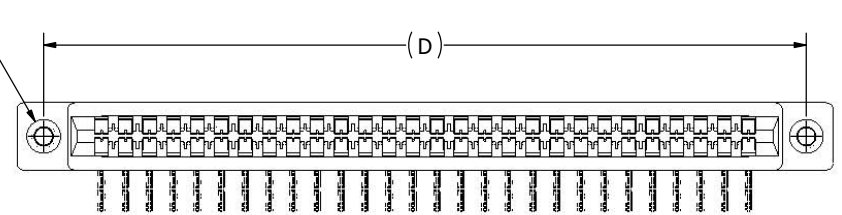

--M_DRAF

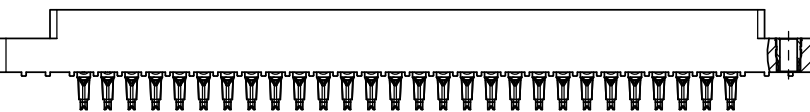
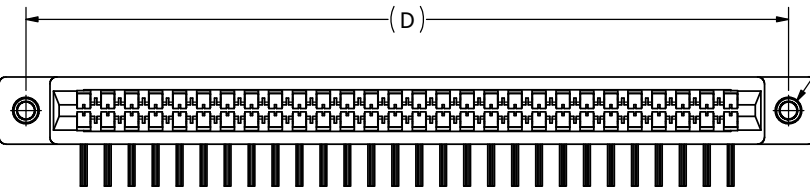

--M_DRAI

CUSTOMER COPY



RoHS COMPLIANT

UNLESS OTHERWISE SPECIFIED:
DIMENSIONS ARE IN INCHES (MM)

TOLERANCES:
ANGULAR: $\pm 1^\circ$
DECIMALS
.XX = $\pm .02$ [.5]
.XXX = $\pm .005$ [.13]
.XXXX = $\pm .0005$ [.013]

DRAWN	DATE	NAME
	11/14/2011	JH

THE INFORMATION HEREIN CONTAINS PROPRIETARY INFORMATION OF SULLINS ELECTRONICS AND IS NOT TO BE REPRODUCED, USED OR DISCLOSED TO OTHERS FOR ANY PURPOSE EXCEPT AS SPECIFICALLY AUTHORIZED IN WRITING BY AN OFFICER OF SULLINS ELECTRONICS.



TITLE EDGE CARD, .156 CC, RAB			
PART NUMBER --M_DRA_ (-S38, S81, S328)			
SIZE C	CAGE CODE 54453	DWG. NO. C11126	REV F
SCALE: 2:1.25			SHEET 2 OF 3

PART NUMBER	NO. OF POS.	FOR 'I' OR 'F' MTG ONLY												F +.005[0.13] / -.015[0.38]	
		A ± .008[0.20]		B ± .008[0.20]		C ± .015[0.38]		D ± .010[0.25]		E ± .020[0.51]		E ± .020[0.51]			
		IN	MM	IN	MM	IN	MM	IN	MM	IN	MM	IN	MM		
M02DRA	2	0.156	3.96	0.476	12.09	0.596	15.14	0.909	23.09	1.158	29.41	1.258	31.95	0.325	8.26
M03DRA	3	0.312	7.92	0.632	16.05	0.752	19.10	1.065	27.05	1.314	33.38	1.414	35.92		
M04DRA	4	0.468	11.89	0.788	20.02	0.908	23.06	1.221	31.01	1.470	37.34	1.570	39.88		
M06DRA	6	0.780	19.81	1.100	27.94	1.220	30.99	1.533	38.94	1.782	45.26	1.882	47.80		
M07DRA	7	0.936	23.77	1.256	31.90	1.376	34.95	1.689	42.90	1.938	49.23	2.038	51.77		
M08DRA	8	1.092	27.74	1.412	35.86	1.532	38.91	1.845	46.86	2.094	53.19	2.194	55.73		
M10DRA	10	1.404	35.66	1.724	43.79	1.844	46.84	2.157	54.79	2.406	61.11	2.506	63.65		
M11DRA	11	1.560	39.62	1.880	47.75	2.000	50.80	2.313	58.75	2.562	65.07	2.662	67.61		
M12DRA	12	1.716	43.59	2.036	51.71	2.156	54.76	2.469	62.71	2.718	69.04	2.818	71.58		
M15DRA	15	2.184	55.47	2.504	63.60	2.624	66.65	2.937	74.60	3.186	80.92	3.286	83.46		
M16DRA	16	2.340	59.44	2.660	67.56	2.780	70.61	3.093	78.56	3.342	84.89	3.442	87.43		
M18DRA	18	2.652	67.36	2.972	75.49	3.092	78.54	3.405	86.49	3.654	92.81	3.754	95.35		
M20DRA	20	2.964	75.29	3.284	83.41	3.404	86.46	3.717	94.41	3.966	100.74	4.066	103.28		
M22DRA	22	3.276	83.21	3.596	91.34	3.716	94.39	4.029	102.34	4.278	108.66	4.378	111.20		
M24DRA	24	3.588	91.14	3.908	99.26	4.028	102.31	4.341	110.26	4.590	116.59	4.690	119.13		
M25DRA	25	3.744	95.10	4.064	103.23	4.184	106.27	4.497	114.22	4.746	120.55	4.846	123.09		
M28DRA	28	4.212	106.98	4.532	115.11	4.652	118.16	4.965	126.11	5.214	132.44	5.314	134.98		
M36DRA	36	5.460	138.68	5.780	146.81	5.900	149.86	6.213	157.81	6.462	164.13	6.562	166.67		
M43DRA	43	6.552	166.42	6.872	174.55	6.992	177.60	7.305	185.55	7.554	191.87	7.654	194.41		
M44DRA	44	6.708	170.38	7.028	178.51	7.148	181.56	7.461	189.51	7.710	195.83	7.810	198.37		

PART NUMBER CODING

M **DRA** **-S**

MATERIAL (INSULATOR/CONTACT)

E = BLUE PBT/PHOSPHOR BRONZE
 OPERATING TEMP: -65°C TO +125°C
 PROCESSING TEMP: WAVE/MANUAL SOLDERING ONLY

R = GREEN PPS/PHOSPHOR BRONZE
 OPERATING TEMP: -65°C TO +125°C
 PROCESSING TEMP: 260°C MAX FOR 20 SECONDS

G = BLACK PA9T/PHOSPHOR BRONZE
 OPERATING TEMP: -65°C TO +125°C
 PROCESSING TEMP: 260°C MAX FOR 20 SECONDS

H = BLUE PBT/BERYLLIUM COPPER
 OPERATING TEMP: -65°C TO +125°C
 PROCESSING TEMP: WAVE/MANUAL SOLDERING ONLY

A = GREEN PPS/BERYLLIUM COPPER
 OPERATING TEMP: -65°C TO +150°C
 PROCESSING TEMP: 260°C MAX FOR 20 SECONDS

J = BLACK PA9T/BERYLLIUM COPPER
 OPERATING TEMP: -65°C TO +150°C
 PROCESSING TEMP: 260°C MAX FOR 20 SECONDS

F = GREEN PPS/SPINODAL (CONSULT FACTORY)
 OPERATING TEMP: -65°C TO +200°C
 AVAILABLE IN OVERALL GOLD ONLY (S OR M PLATING CODE)
 PROCESSING TEMP: 260°C MAX FOR 20 SECONDS
 (CONSULT FACTORY FOR SPECIAL SOLDERING REQUIREMENTS)

C = GREEN PPS/BERYLLIUM NICKEL (CONSULT FACTORY)
 AVAILABLE IN OVERALL GOLD ONLY (S OR M PLATING CODE)
 OPERATING TEMP: -65°C TO +200°C
 PROCESSING TEMP: 260°C MAX FOR 20 SECONDS

W = TAN PEEK/BERYLLIUM NICKEL (CONSULT FACTORY)
 AVAILABLE IN OVERALL GOLD ONLY (M PLATING CODE)
 OPERATING TEMP: -65°C TO +250°C
 PROCESSING TEMP: 260°C MAX FOR 20 SECONDS

MODIFICATION

OMIT = STANDARD, EX: 'EBM22DRAH'
 S38 = BLACK PBT (MATERIAL CODES E & H ONLY)
 S81 = GREEN PBT (MATERIAL CODES E & H ONLY)
 S328 = BROWN PPS (MATERIAL CODES A, R, F, AND C ONLY)

MOUNTING STYLE

H = .125" DIA. CLEARANCE HOLES
 N = NO MOUNTING EARS
 S = .125" DIA. SIDE MOUNTING
 I = #4-40 THREADED INSERT
 F = FLOATING BOBBIN
 A = #4-40 THREADED INSERT IN SIDE HOLES

NUMBER OF POSITIONS

(CONTACTS PER ROW)

PLATING

ALL PLATINGS HAVE .000050" NICKEL UNDERPLATE

CONTACT SURFACE	TERMINATION
B = .00010" GOLD	.000100" PURE TIN, MATTE
C = .00030" GOLD	.000100" PURE TIN, MATTE
G = .00010" GOLD	.000005" GOLD
Y = .00030" GOLD	.000005" GOLD
*E = .000100" PURE TIN, MATTE	OVERALL
S = .00010" GOLD OVERALL	
M = .00030" GOLD	.000010" GOLD OVERALL

*OVERALL TIN ONLY AVAILABLE ON MATERIAL CODES E, R, AND G

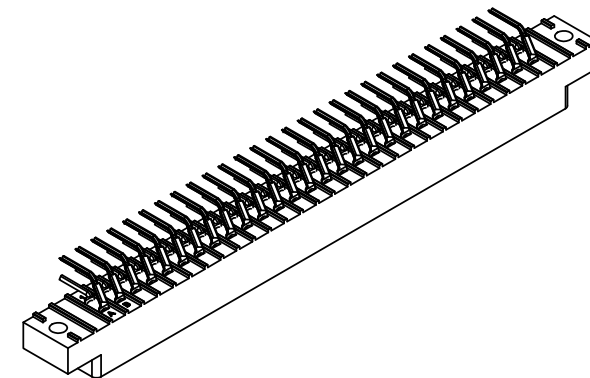

CUSTOMER COPY



RoHS COMPLIANT

UNLESS OTHERWISE SPECIFIED: DIMENSIONS ARE IN INCHES (MM)		DRAWN	DATE	NAME	
TOLERANCES:			11/14/2011	JH	
ANGULAR: ± 1°		<small>THE INFORMATION HEREIN CONTAINS PROPRIETARY INFORMATION OF SULLINS ELECTRONICS AND IS NOT TO BE REPRODUCED, USED OR DISCLOSED TO OTHERS FOR ANY PURPOSE EXCEPT AS SPECIFICALLY AUTHORIZED IN WRITING BY AN OFFICER OF SULLINS ELECTRONICS.</small>			TITLE
DECIMALS					EDGE CARD, .156 CC, RAB
.XX = ± .02 [5]					PART NUMBER
.XXX = ± .005 [13]					M DRA (-S38, S81, S328)
.XXXX = ± .0005 [013]		SIZE	CAGE CODE	DWG. NO.	REV
		C	54453	C11126	F
		SCALE: 1.5:1	SHEET 3 OF 3		