

ANT-5GWWS6-SMA Cellular Sub-6 5G Antenna

The ANT-5GWWS6-SMA is a dipole, blade-style antenna for 5G New Radio, LTE, and cellular IoT (LTE-M, NB-IoT) applications requiring a cost-effective but capable antenna solution.

The ANT-5GWWS6-SMA allows for the antenna to be positioned for optimum performance. The antenna attaches with an SMA plug (male pin) connector.



Features

- Wide Bandwidth 617 MHz to 5925 MHz
- Performance at 617 MHz to 698 MHz
 - VSWR: ≤ 1.6
 - Peak Gain: 5.3 dBi
 - Efficiency: 76%
- Performance at 3300 MHz to 4200 MHz
 - VSWR: ≤ 1.8
 - Peak Gain: 5.5 dBi
 - Efficiency: 80%
- Hinged design with detents for straight, 45 degree and 90 degree positioning
- SMA plug (male pin)

Applications

- Worldwide 5G/4G/3G/2G
- Cellular IoT: LTE-M (Cat-M1) and NB-IoT
- Internet of Things (IoT) devices
- Home and business networking

Ordering Information

Part Number	Description
ANT-5GWWS6-SMA	Cellular 5G blade-style antenna with SMA plug (male pin) connector

Available from LinX Technologies and select distributors and representatives.

Table 1. Electrical Specifications

Bands	Frequency Range	VSWR (max.)	Peak Gain (dBi)	Avg. Gain (dBi)	Efficiency (%)
71	617 MHz to 698 MHz	1.6	5.3	-1.5	76
12, 13, 14, 17, 26, 28, 29, 44, 67, 68, 85, n83	698 MHz to 803 MHz	1.7	6.0	-1.4	77
5, 18, 19, 20, 26, 27, n82, n89	791 MHz to 894 MHz	2.1	6.0	-2.4	62
8, 11, 21, 32, 45, 50, 51, 74, 75, 76, n81, n91, n92, n93, n94	832 MHz to 1518 MHz	3.9	7.1	-3.5	52
24	1525 MHz to 1661 MHz	1.8	7.0	-1.9	69
1, 2, 3, 4, 9, 10, 23, 25, 33, 34, 35, 36, 37, 39, 65, 66, 70, n80, n84, n86, n95	1695 MHz to 2200 MHz	1.9	8.9	-1.7	74
7, 30, 38, 40, 41, 53, 69, n90	2300 MHz to 2690 MHz	1.9	8.5	-1.2	83
22, 42, 43, 48, 49, 52, n77, n78	3300 MHz to 4200 MHz	1.8	5.5	-1.3	80
n79	4400 MHz to 5000 MHz	1.8	3.9	-1.5	75
46, 47	5150 MHz to 5925 MHz	2.0	4.9	-2.1	65
Polarization	Linear				
Radiation	Omnidirectional				
Max Power	10 W				
Wavelength	1/2-wave				
Electrical Type	Dipole				
Impedance	50 Ω				

Electrical specifications and plots measured with the antenna in free space.

Table 2. Mechanical Specifications

Parameter	Value
Connection	SMA plug (male pin)
Operating Temperature Range	-40 °C to +85 °C
Weight	16.7 g (0.59 oz)
Dimensions	135.6 mm x 24.1 mm x 11.0 mm (5.34 in x 0.95 in x 0.43 in)

Packaging Information

The ANT-5GWWS6-SMA antenna is individually placed in a clear polyethylene bag. Plastic bags are sealed in a larger polyethylene bag in quantities of 50 pcs. Bags are placed in cartons of 400 pcs. Distribution channels may offer alternative packaging options.

Product Dimensions

Figure 1 provides dimensions of the ANT-5GWWS6-SMA antenna. The antenna whip can be tilted 90 degrees, with a detent at 45 degrees enabling the antenna to be oriented in any direction. The rotating base allows for continuous positioning through 360 degrees even while installed.

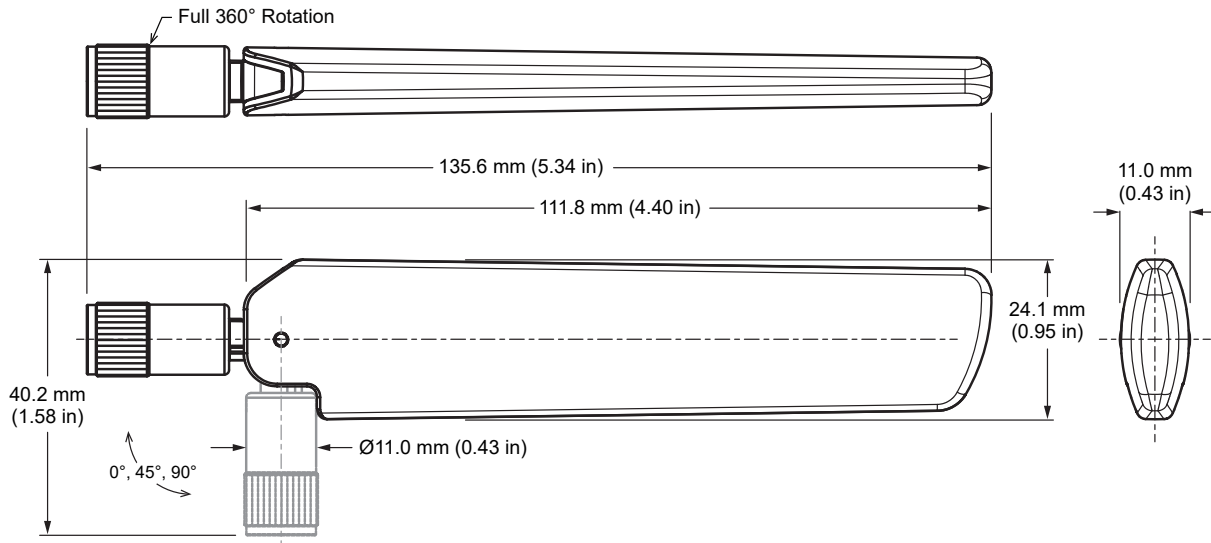

Figure 1. ANT-5GWWS6-SMA Antenna Dimensions

Antenna Orientation

The ANT-5GWWS6-SMA antenna is characterized in two antenna orientations as shown in Figure 2. The antenna straight orientation characterizes use of an antenna attached to an enclosure-mounted connector which is connected by cable to a printed circuit board. Although the antenna is a dipole not requiring a ground plane for function, characterization with an adjacent ground plane (102 mm x 102 mm) provides insight into antenna performance when attached directly to a printed circuit board mounted connector. The two orientations represent the most common end-product use cases.

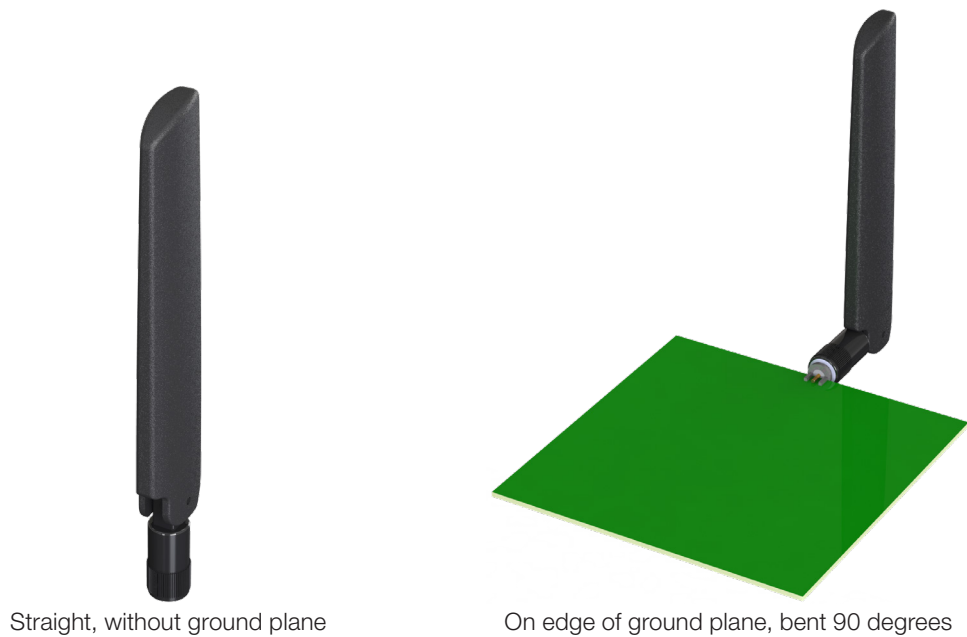

Figure 2. ANT-5GWWS6-SMA Test Orientation

Straight, No Ground Plane

The charts on the following pages represent data taken with the antenna oriented straight, as shown in Figure 3.



Figure 3. ANT-5GWWS6-SMA Straight, No Ground Plane (Straight)

VSWR

Figure 4 provides the voltage standing wave ratio (VSWR) across the antenna bandwidth. VSWR describes the power reflected from the antenna back to the radio. A lower VSWR value indicates better antenna performance at a given frequency. Reflected power is also shown on the right-side vertical axis as a gauge of the percentage of transmitter power reflected back from the antenna.

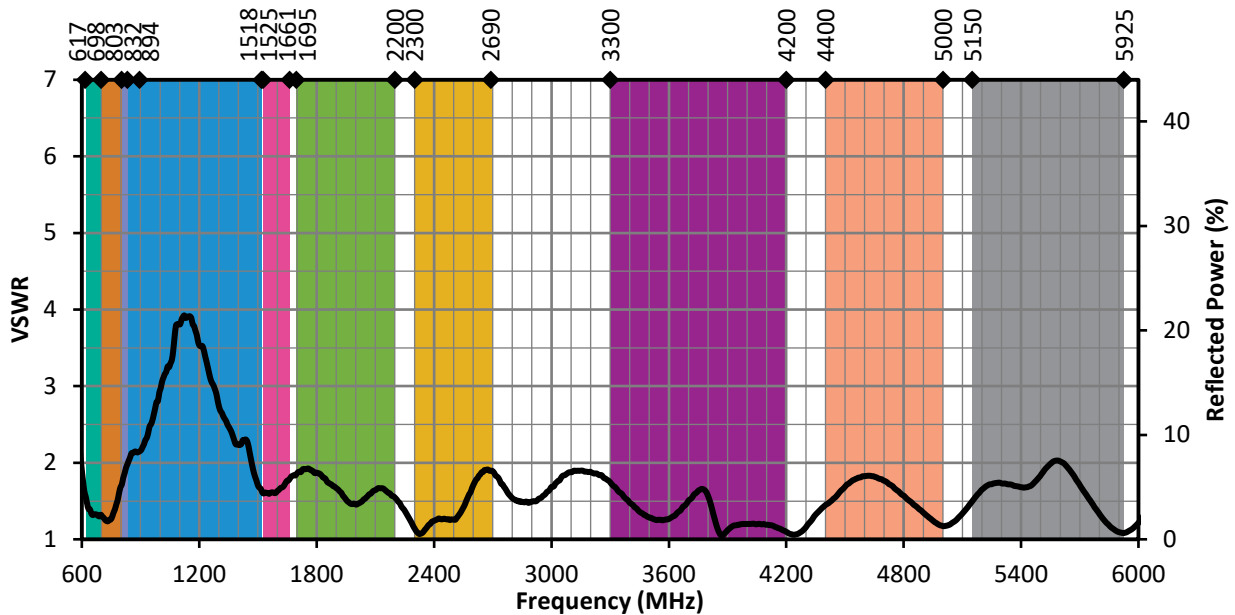

Figure 4. ANT-5GWWS6-SMA VSWR, Straight

Return Loss

Return loss (Figure 5), represents the loss in power at the antenna due to reflected signals. Like VSWR, a lower return loss value indicates better antenna performance at a given frequency.

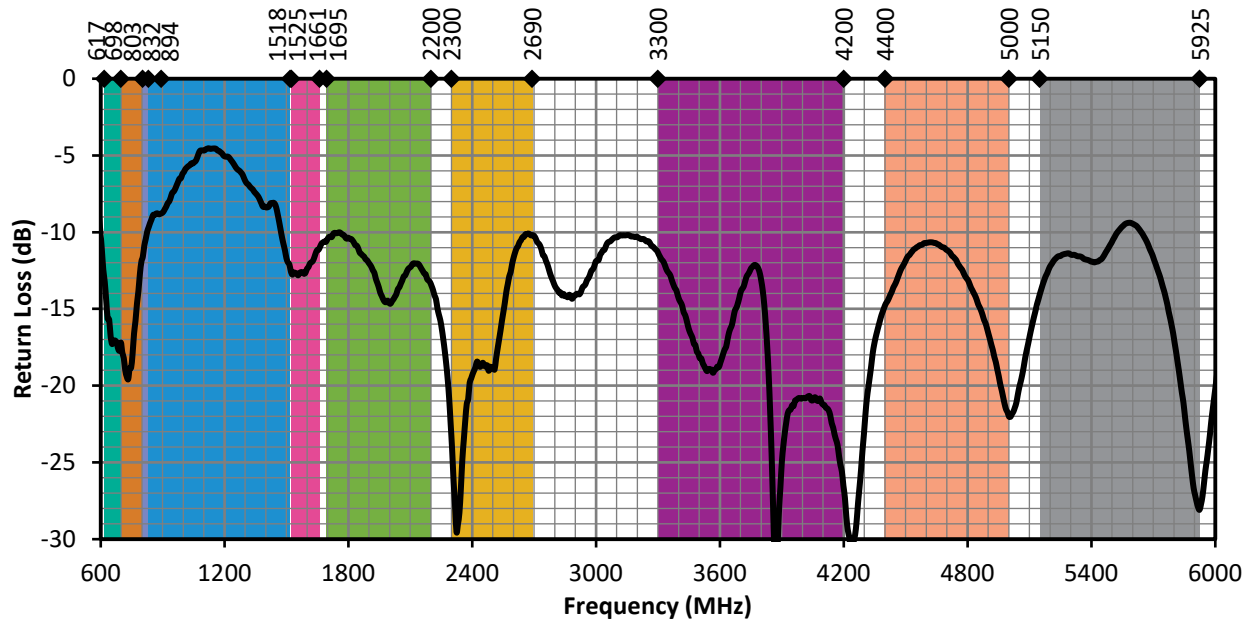

Figure 5. ANT-5GWWS6-SMA Return Loss, Straight

Peak Gain

The peak gain across the antenna bandwidth is shown in Figure 6. Peak gain represents the maximum antenna input power concentration across 3-dimensional space, and therefore peak performance at a given frequency, but does not consider any directionality in the gain pattern.

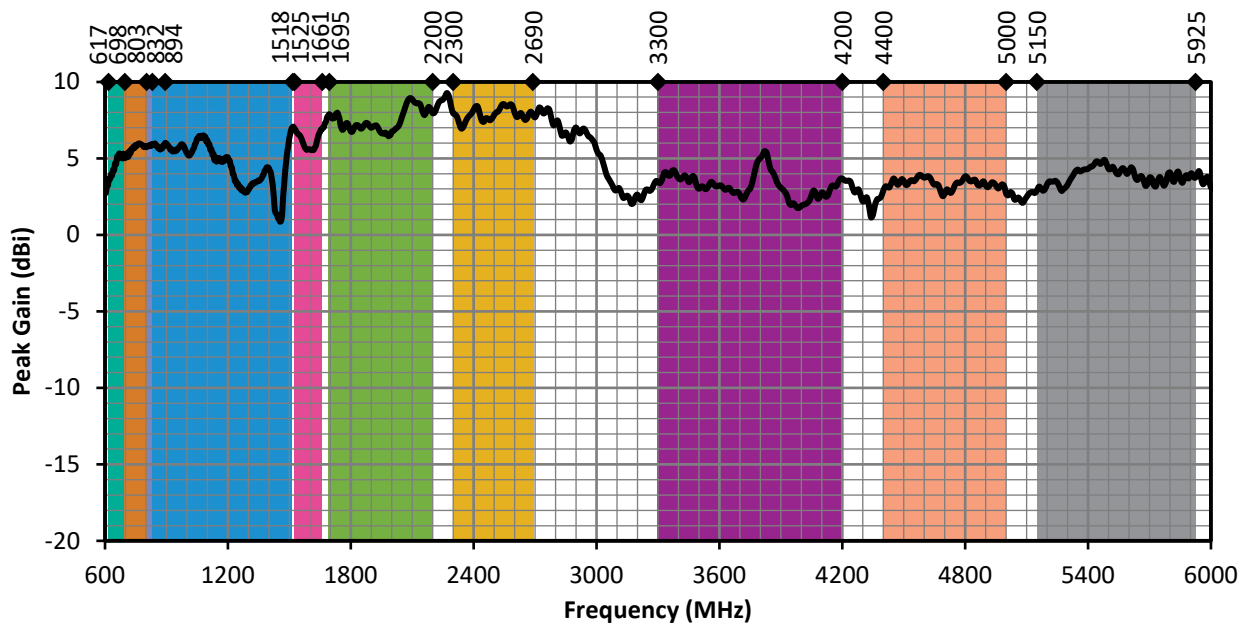

Figure 6. ANT-5GWWS6-SMA Peak Gain, Straight

Average Gain

Average gain (Figure 7), is the average of all antenna gain in 3-dimensional space at each frequency, providing an indication of overall performance without expressing antenna directionality.

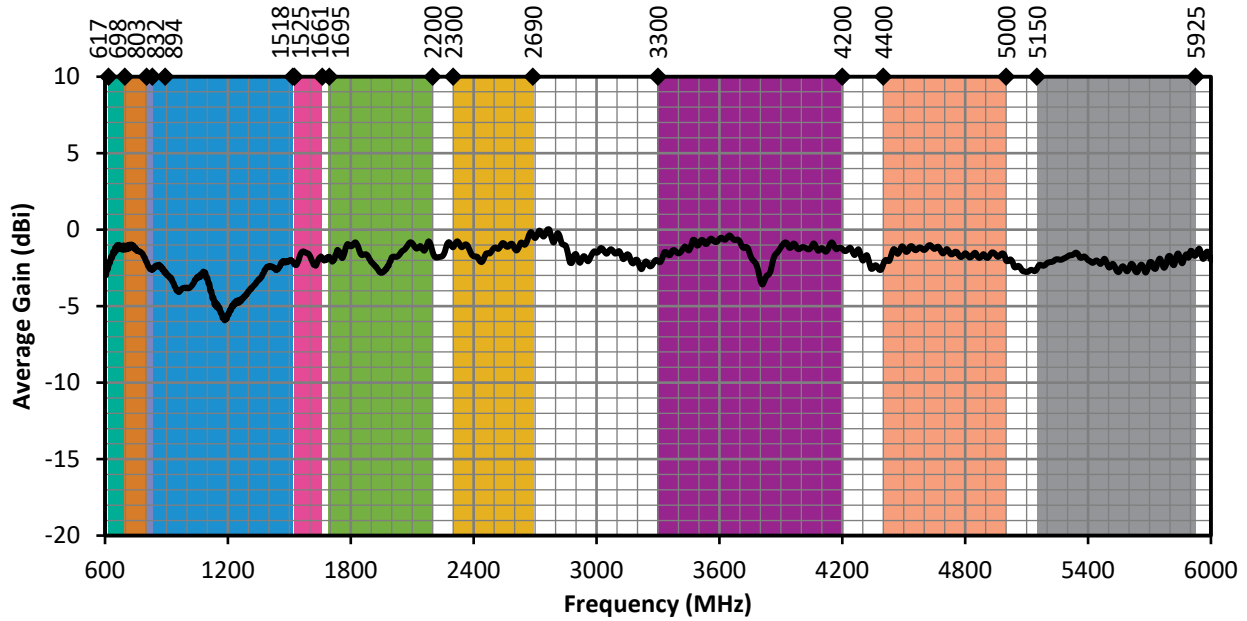

Figure 7. ANT-5GWWS6-SMA Antenna Average Gain, Straight

Radiation Efficiency

Radiation efficiency (Figure 8), shows the ratio of power delivered to the antenna relative to the power radiated at the antenna, expressed as a percentage, where a higher percentage indicates better performance at a given frequency.

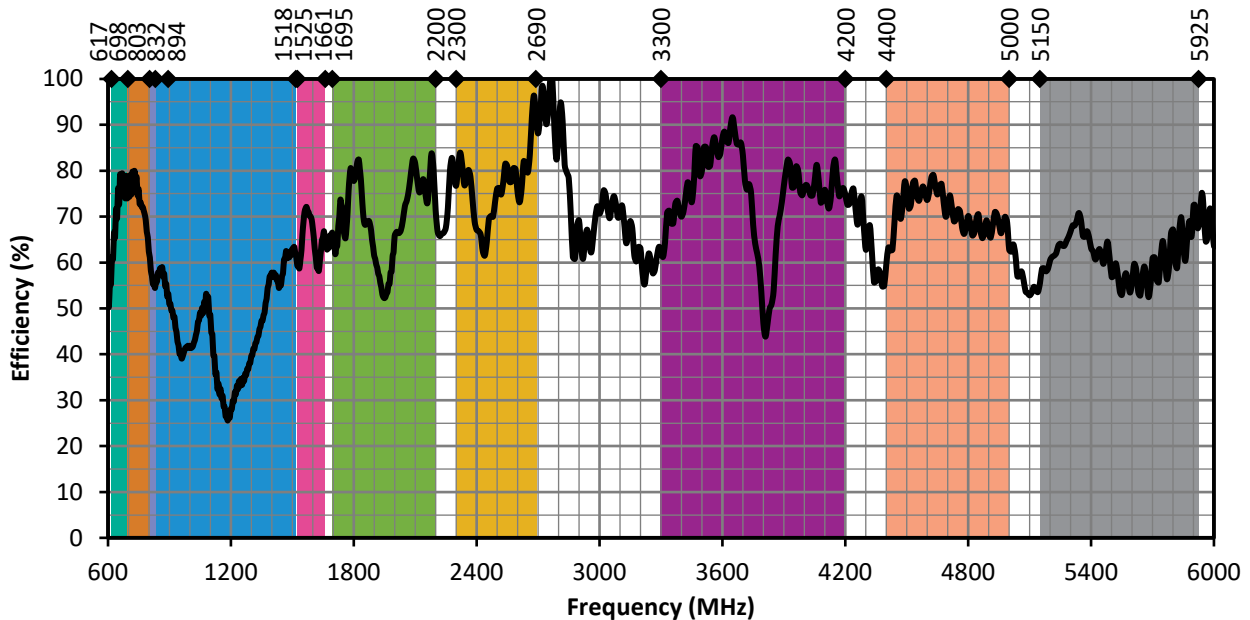

Figure 8. ANT-5GWWS6-SMA Antenna Efficiency, Straight

Radiation Patterns

Radiation patterns provide information about the directionality and 3-dimensional gain performance of the antenna by plotting gain at specific frequencies in three orthogonal planes. Antenna radiation patterns for a straight orientation are shown in Figure 9 using polar plots covering 360 degrees. The antenna graphic at the top of the page provides reference to the plane of the column of plots below it. Note: when viewed with typical PDF viewing software, zooming into radiation patterns is possible to reveal fine detail.

Radiation Patterns - Straight



XZ-Plane Gain



YZ-Plane Gain



XY-Plane Gain

617 MHz to 698 MHz (660 MHz)

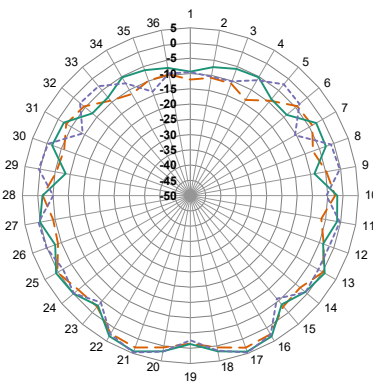

XZ-Plane Gain

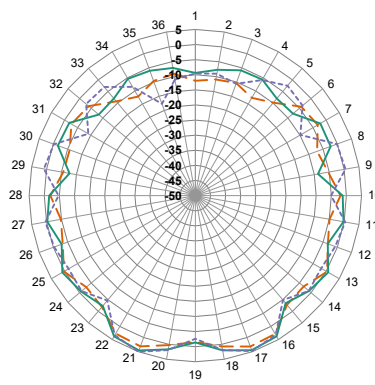

YZ-Plane Gain

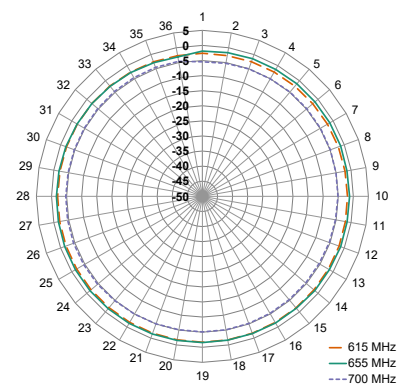

XY-Plane Gain

615 MHz
655 MHz
700 MHz

698 MHz to 803 MHz (750 MHz)

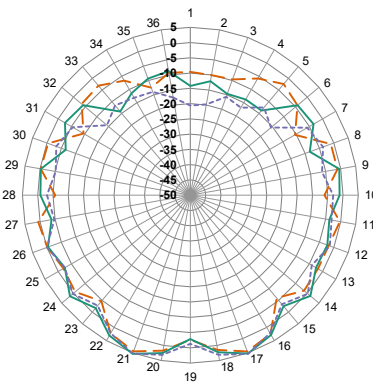

XZ-Plane Gain

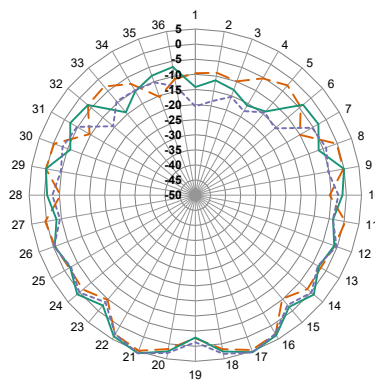

YZ-Plane Gain

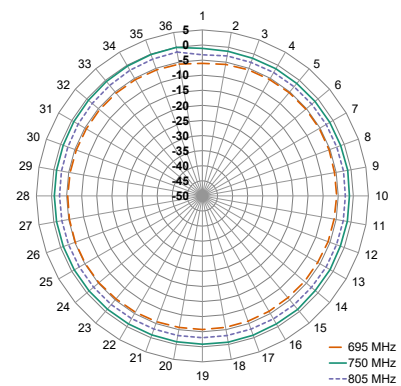

XY-Plane Gain

695 MHz
750 MHz
805 MHz

Radiation Patterns - Straight
791 MHz to 894 MHz (840 MHz)

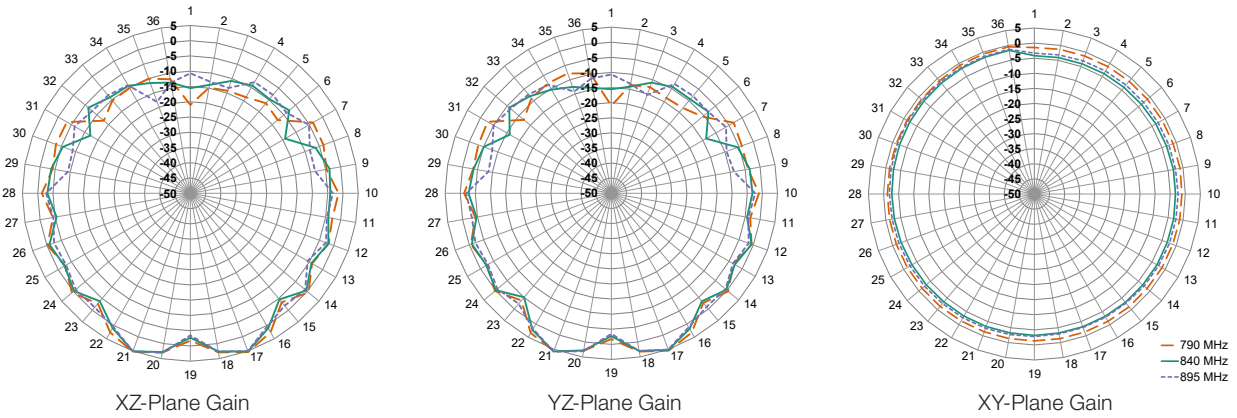

832 MHz to 1518 MHz (1175 MHz)

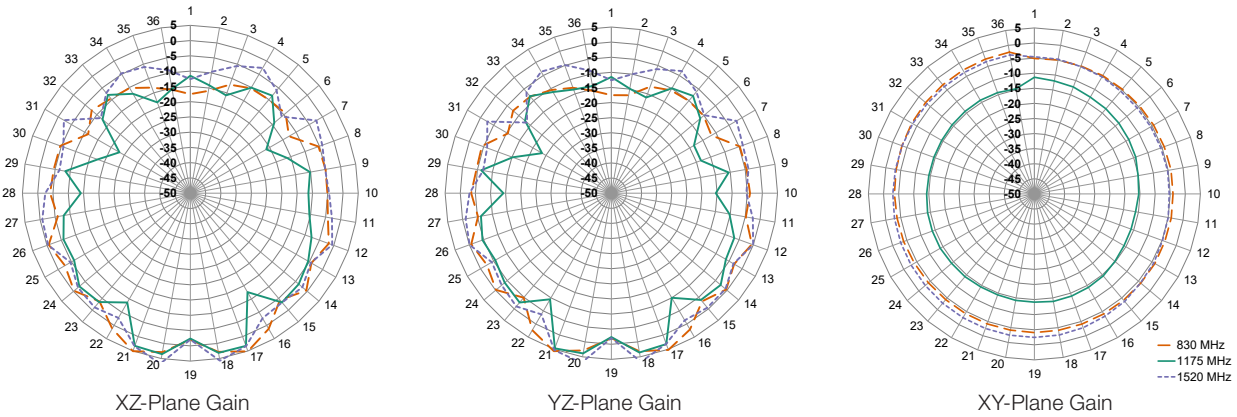

1525 MHz to 1661 MHz (1590 MHz)

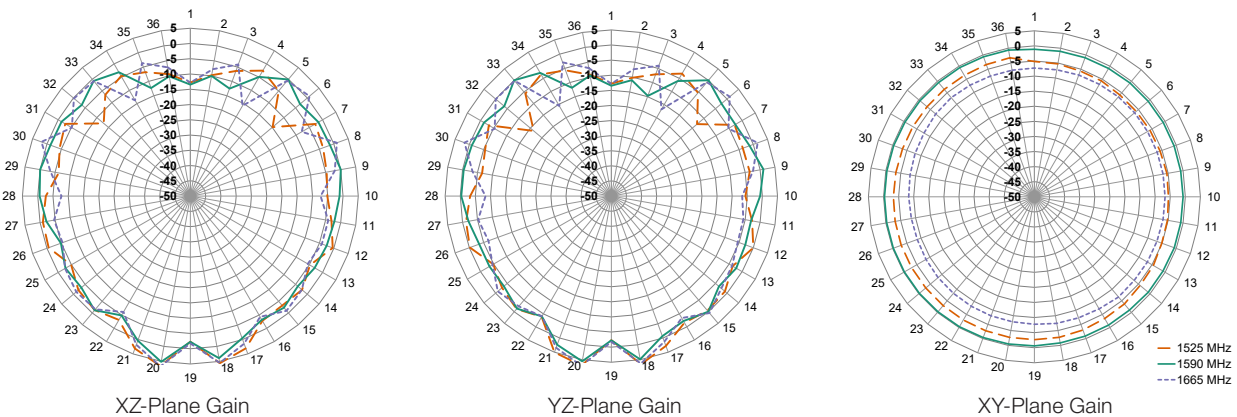

Radiation Patterns - Straight

1695 MHz to 2200 MHz (1945 MHz)

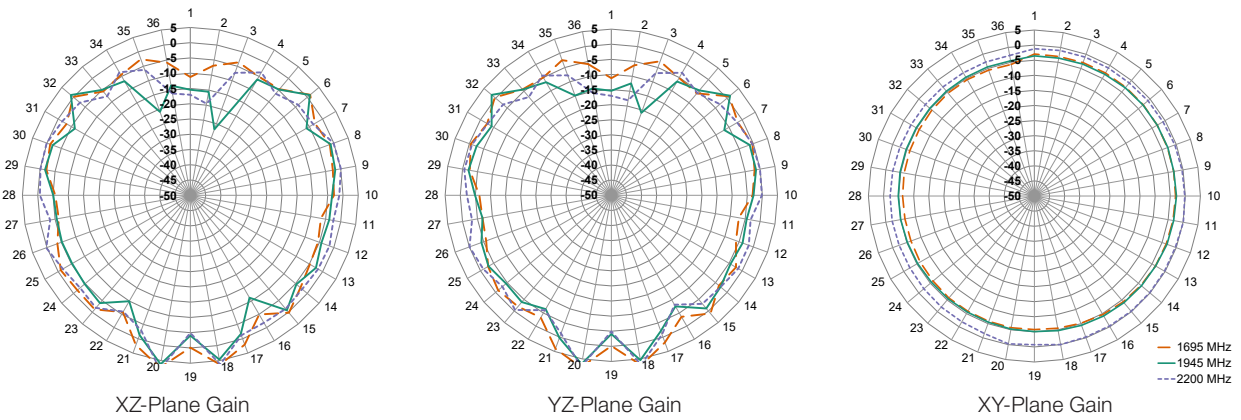

2300 MHz to 2690 MHz (2490 MHz)

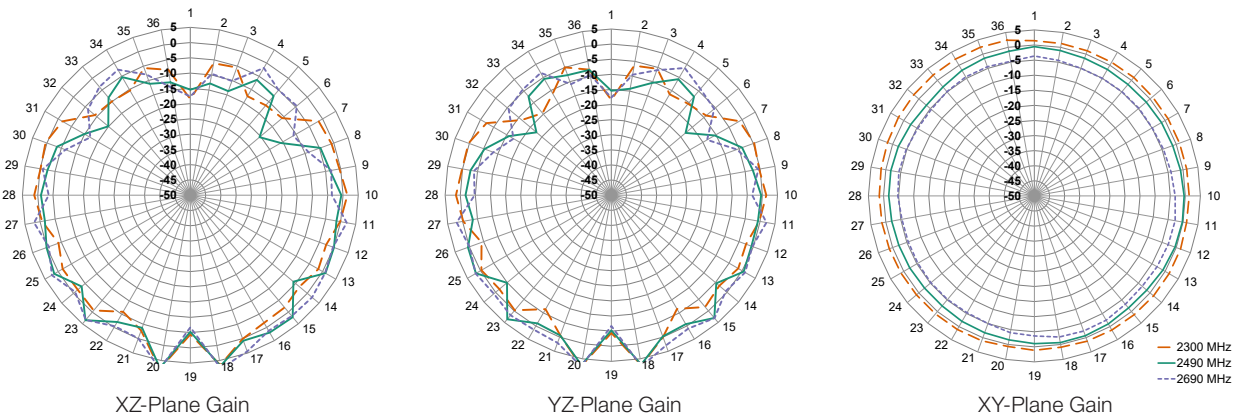

3300 MHz to 4200 MHz (3750 MHz)

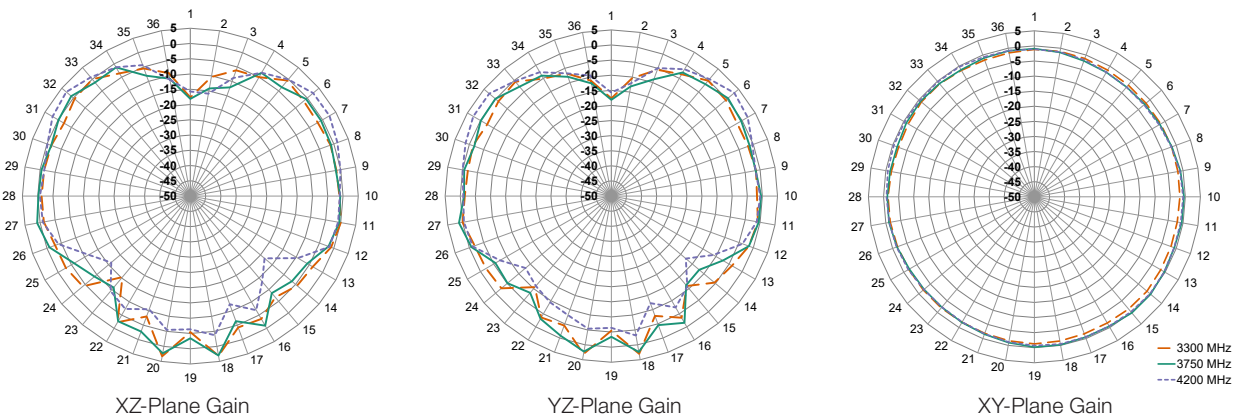

Radiation Patterns - Straight
4400 MHz to 5000 MHz (4700 MHz)

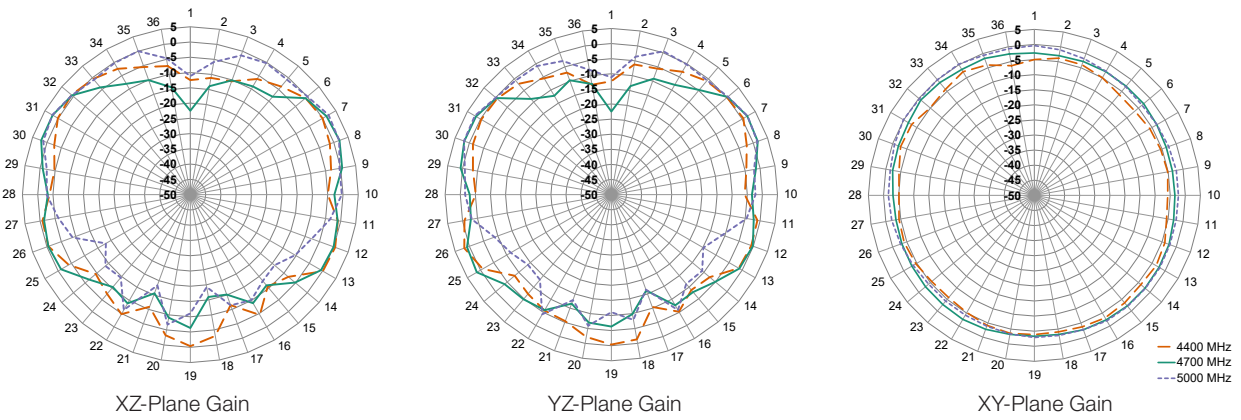

5150 MHz to 5925 MHz (5530 MHz)

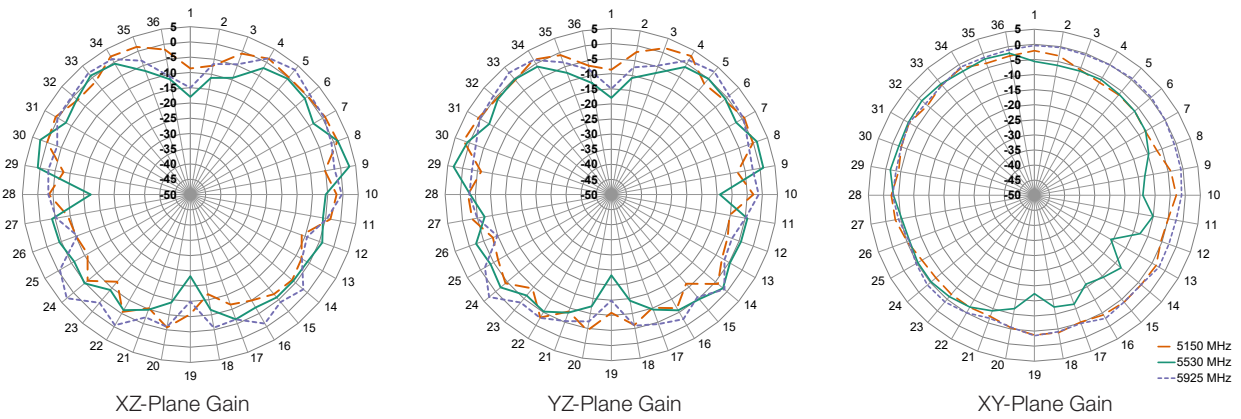

Figure 9. Radiation Patterns for ANT-5GWWS6-SMA, Straight

Edge of Ground Plane, Bent 90 Degrees

The charts on the following pages represent data taken with the antenna oriented at the edge of the ground plane, bent 90 degrees (Edge-Bent), as shown in Figure 10.



Figure 10. ANT-5GWWS6-SMA on Edge of Ground Plane, Bent 90 Degrees (Edge-Bent)

VSWR

Figure 11 provides the voltage standing wave ratio (VSWR) across the antenna bandwidth. VSWR describes the power reflected from the antenna back to the radio. A lower VSWR value indicates better antenna performance at a given frequency. Reflected power is also shown on the right-side vertical axis as a gauge of the percentage of transmitter power reflected back from the antenna.

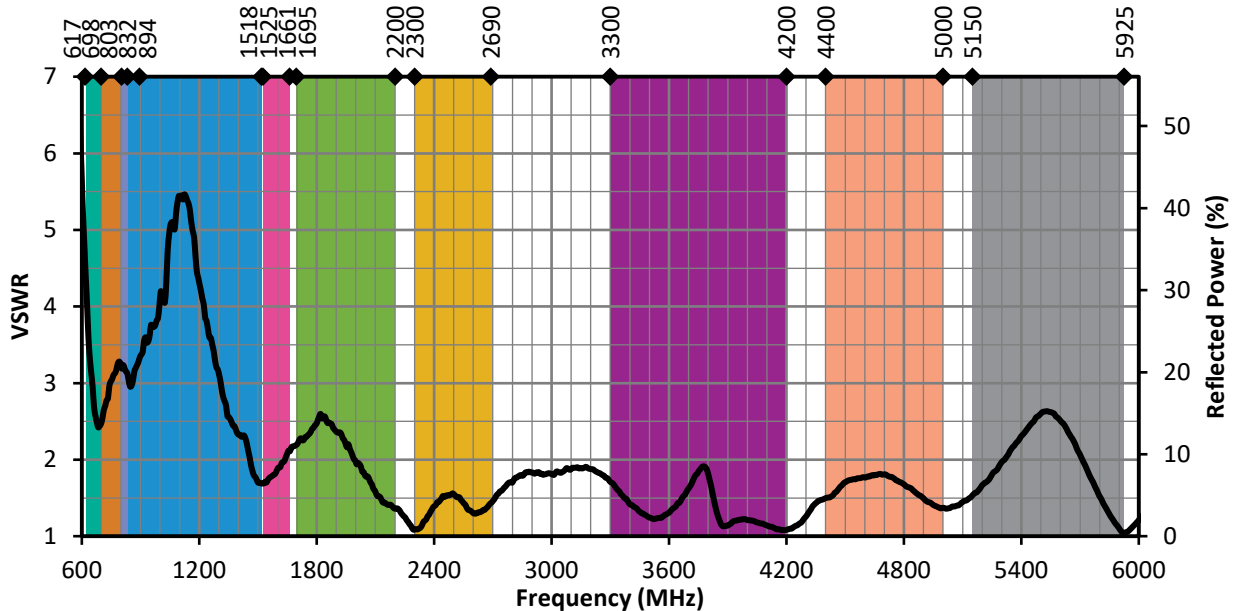

Figure 11. ANT-5GWWS6-SMA VSWR, Edge-Bent

Return Loss

Return loss (Figure 12), represents the loss in power at the antenna due to reflected signals. Like VSWR, a lower return loss value indicates better antenna performance at a given frequency.

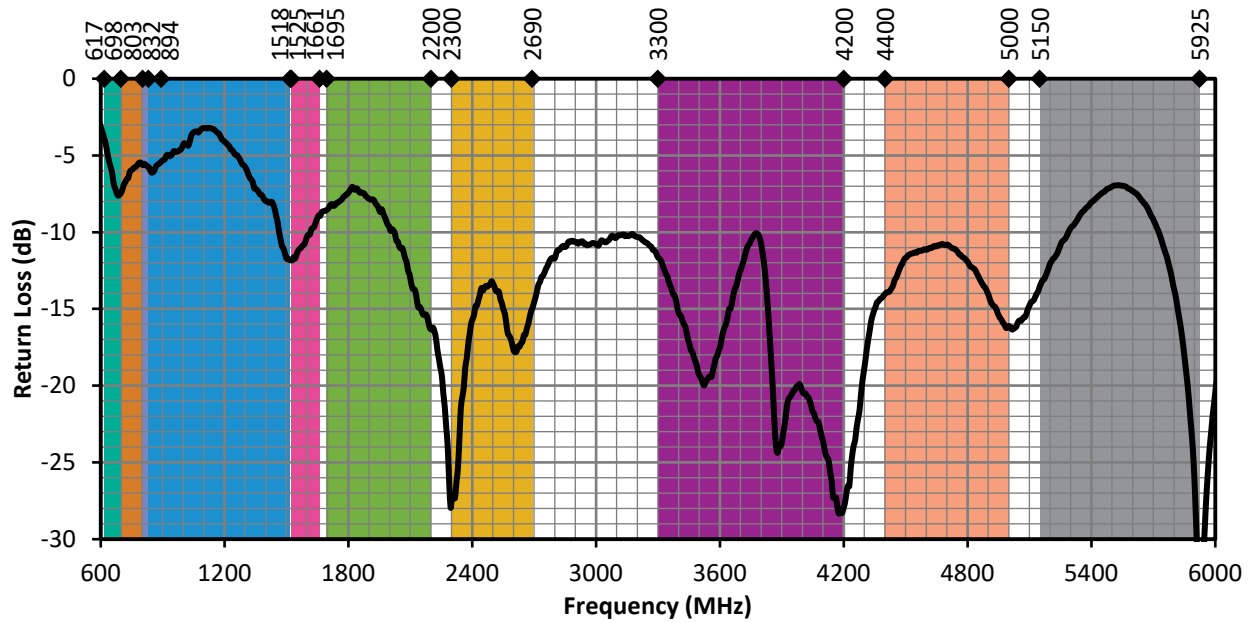

Figure 12. ANT-5GWWS6-SMA Return Loss, Edge-Bent

Peak Gain

The peak gain across the antenna bandwidth is shown in Figure 13. Peak gain represents the maximum antenna input power concentration across 3-dimensional space, and therefore peak performance at a given frequency, but does not consider any directionality in the gain pattern.

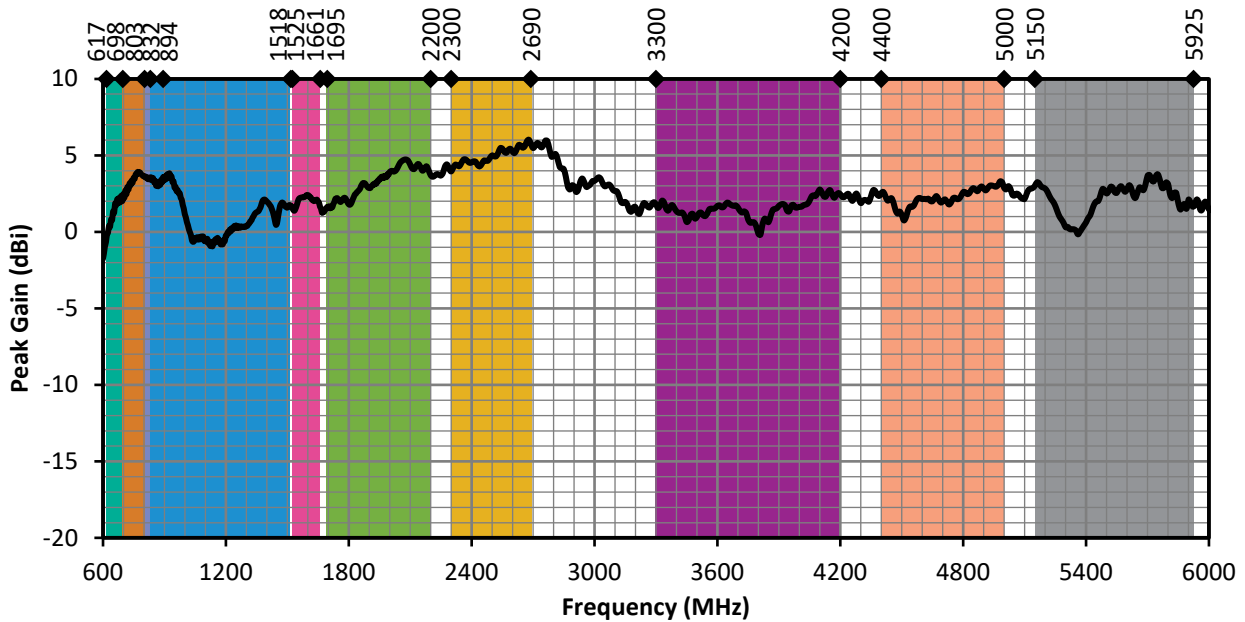

Figure 13. ANT-5GWWS6-SMA Peak Gain, Edge-Bent

Average Gain

Average gain (Figure 14), is the average of all antenna gain in 3-dimensional space at each frequency, providing an indication of overall performance without expressing antenna directionality.

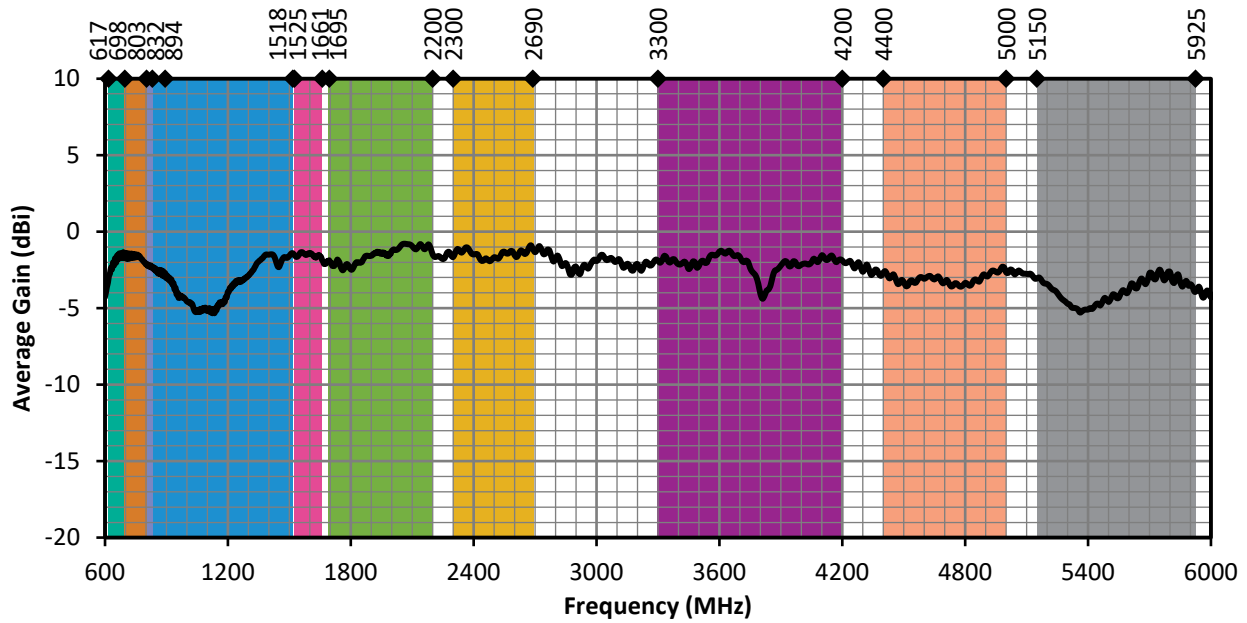

Figure 14. ANT-5GWWS6-SMA Antenna Average Gain, Edge-Bent

Radiation Efficiency

Radiation efficiency (Figure 15), shows the ratio of power delivered to the antenna relative to the power radiated at the antenna, expressed as a percentage, where a higher percentage indicates better performance at a given frequency.

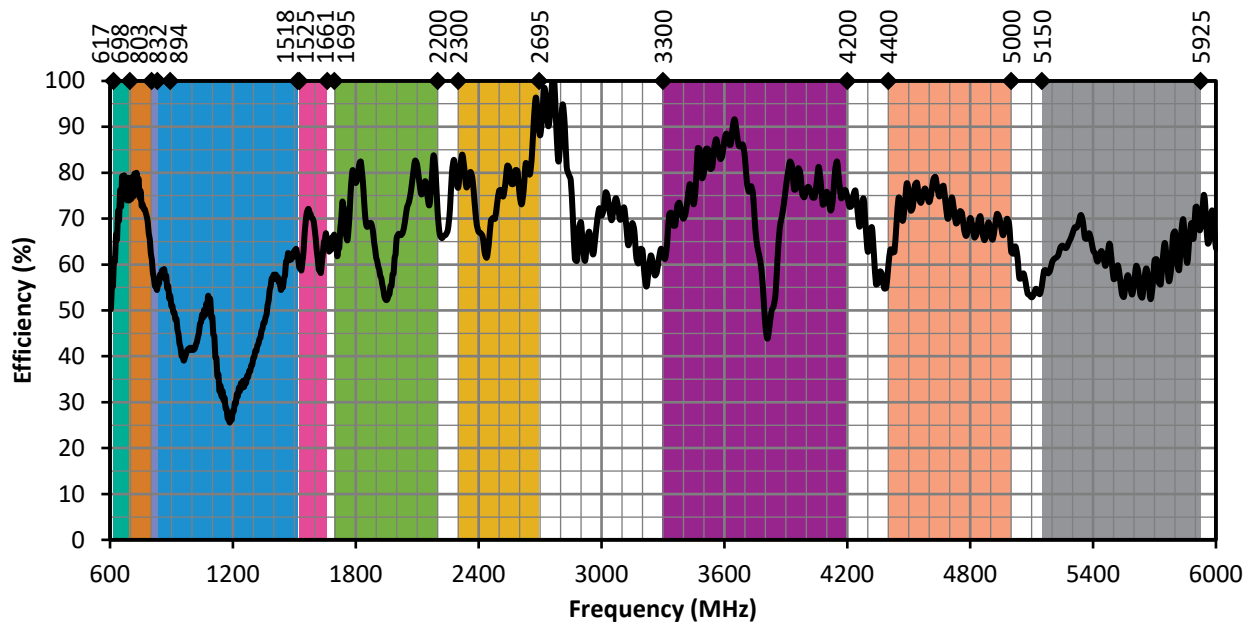
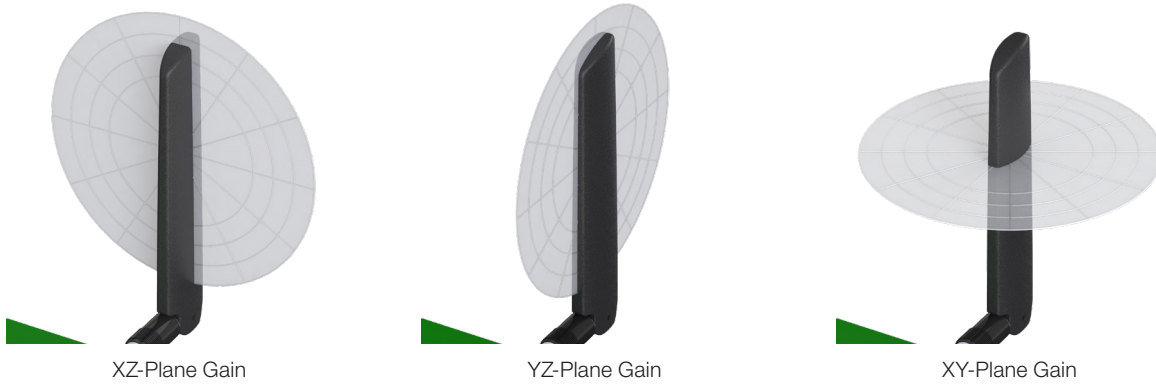

Figure 15. ANT-5GWWS6-SMA Antenna Efficiency, Edge-Bent

Radiation Patterns

Radiation patterns provide information about the directionality and 3-dimensional gain performance of the antenna by plotting gain at specific frequencies in three orthogonal planes. Antenna radiation patterns for an Edge-Bent orientation are shown in Figure 16 using polar plots covering 360 degrees. The antenna graphic at the top of the page provides reference to the plane of the column of plots below it. Note: when viewed with typical PDF viewing software, zooming into radiation patterns is possible to reveal fine detail.

Radiation Patterns - Edge-Bent



617 MHz to 698 MHz (660 MHz)

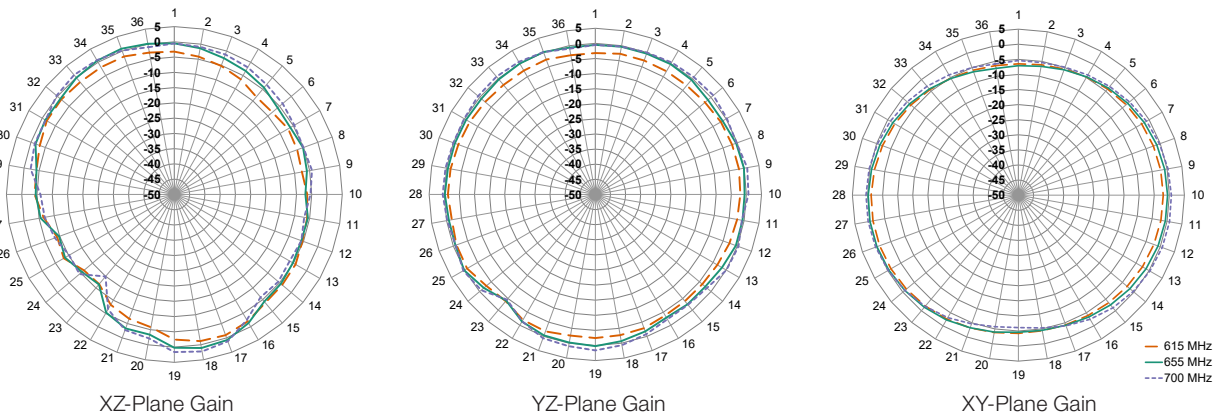

698 MHz to 803 MHz (750 MHz)

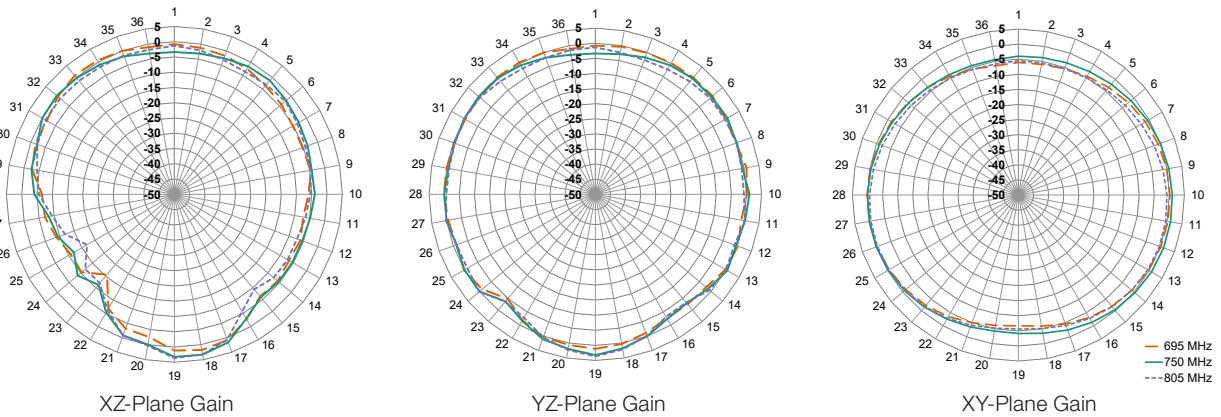

Radiation Patterns - Edge-Bent
791 MHz to 894 MHz (840 MHz)

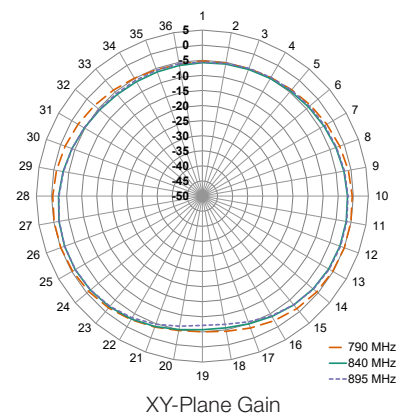
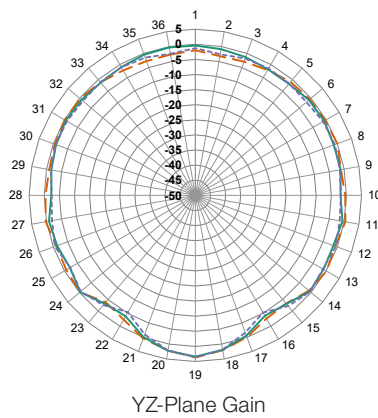
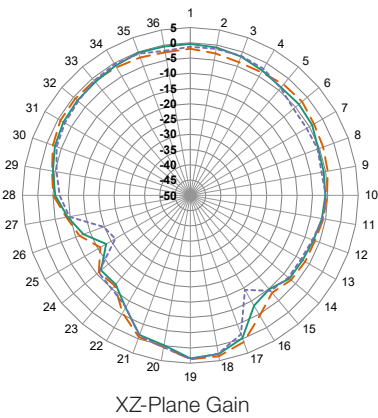

832 MHz to 1518 MHz (1175 MHz)

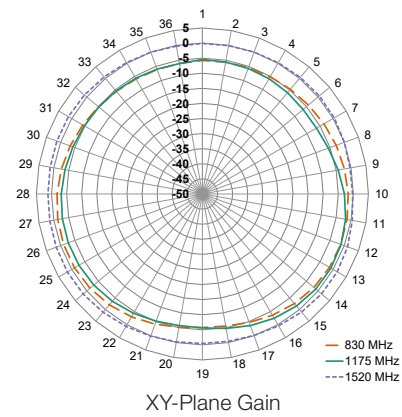
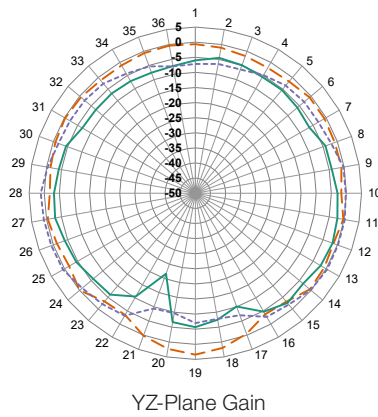
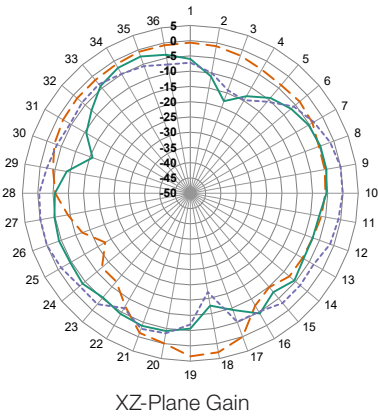

1525 MHz to 1661 MHz (1590 MHz)

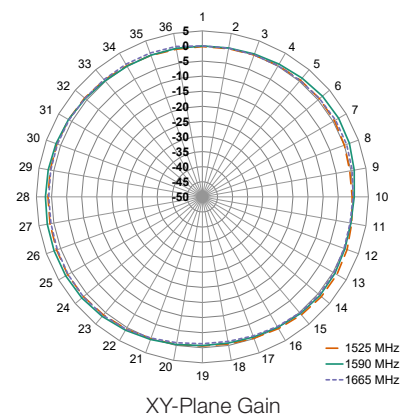
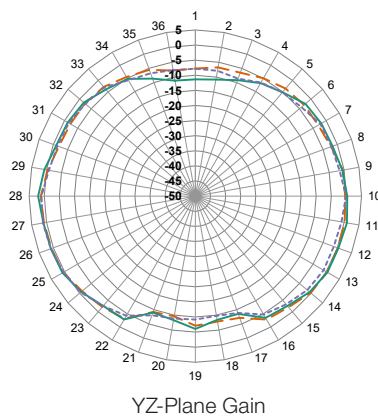
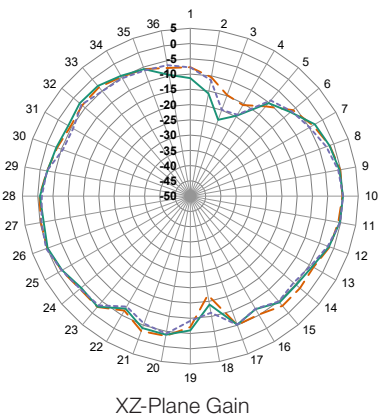

Radiation Patterns - Edge-Bent

1695 MHz to 2200 MHz (1945 MHz)

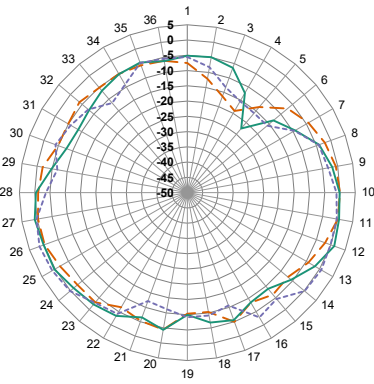

XZ-Plane Gain

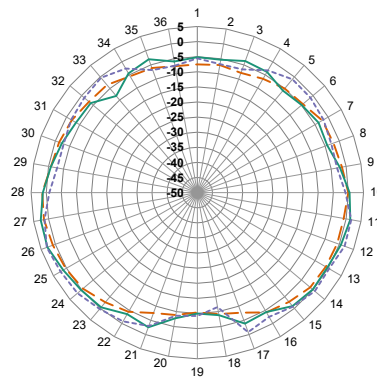

YZ-Plane Gain

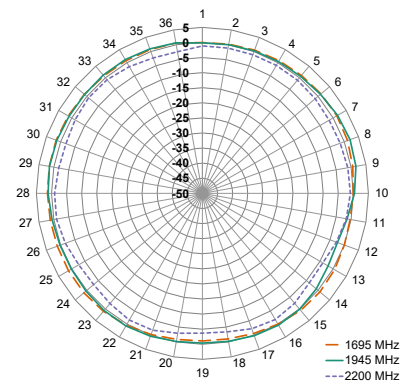

XY-Plane Gain

2300 MHz to 2690 MHz (2490 MHz)

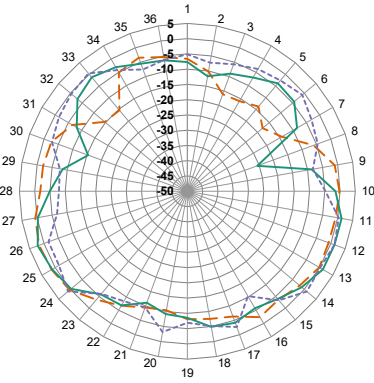

XZ-Plane Gain

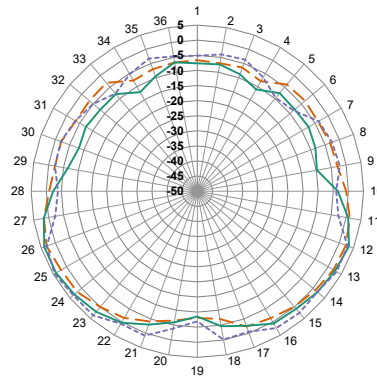

YZ-Plane Gain

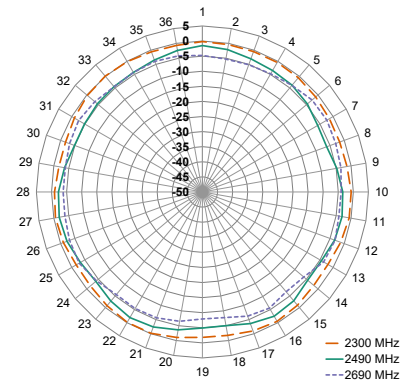

XY-Plane Gain

3300 MHz to 4200 MHz (3750 MHz)

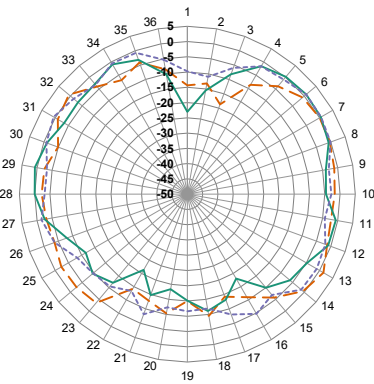

XZ-Plane Gain

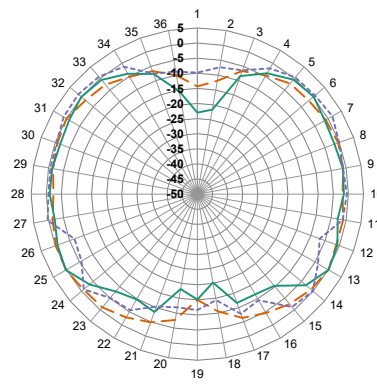

YZ-Plane Gain

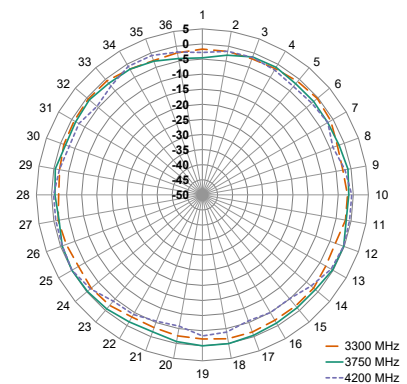

XY-Plane Gain

Radiation Patterns - Edge-Bent

4400 MHz to 5000 MHz (4700 MHz)

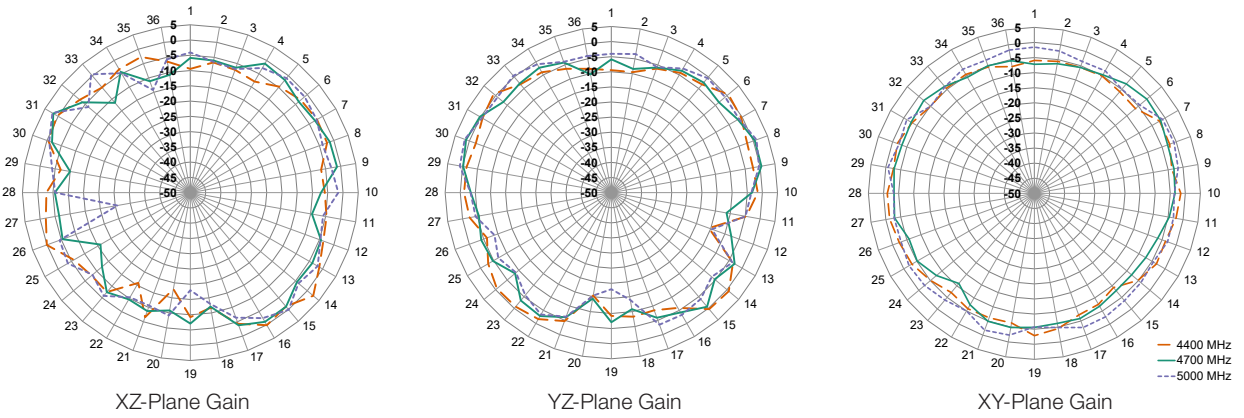

5150 MHz to 5925 MHz (5530 MHz)

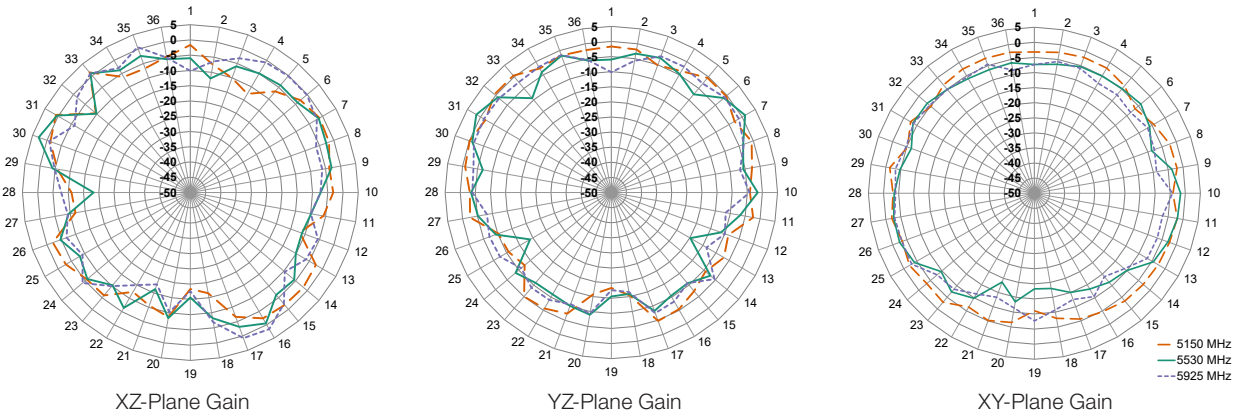

Figure 16. Radiation Patterns for ANT-5GWWS6-SMA, Edge-Bent

Website: <http://linxtechnologies.com>
Linx Offices: 159 Ort Lane, Merlin, OR, US 97532
Phone: +1 (541) 471-6256
E-MAIL: info@linxtechnologies.com

Linx Technologies reserves the right to make changes to the product(s) or information contained herein without notice. No liability is assumed as a result of their use or application. No rights under any patent accompany the sale of any such product(s) or information.

Wireless Made Simple is a registered trademark of Linx Acquisitions LLC. Other product and brand names may be trademarks or registered trademarks of their respective owners.

Copyright © 2022 Linx Technologies

All Rights Reserved

Doc# DS22222-259ANT

