

RPC-N
50 Ω

Attenuator
Plug/Jack

05AS122-K03S3

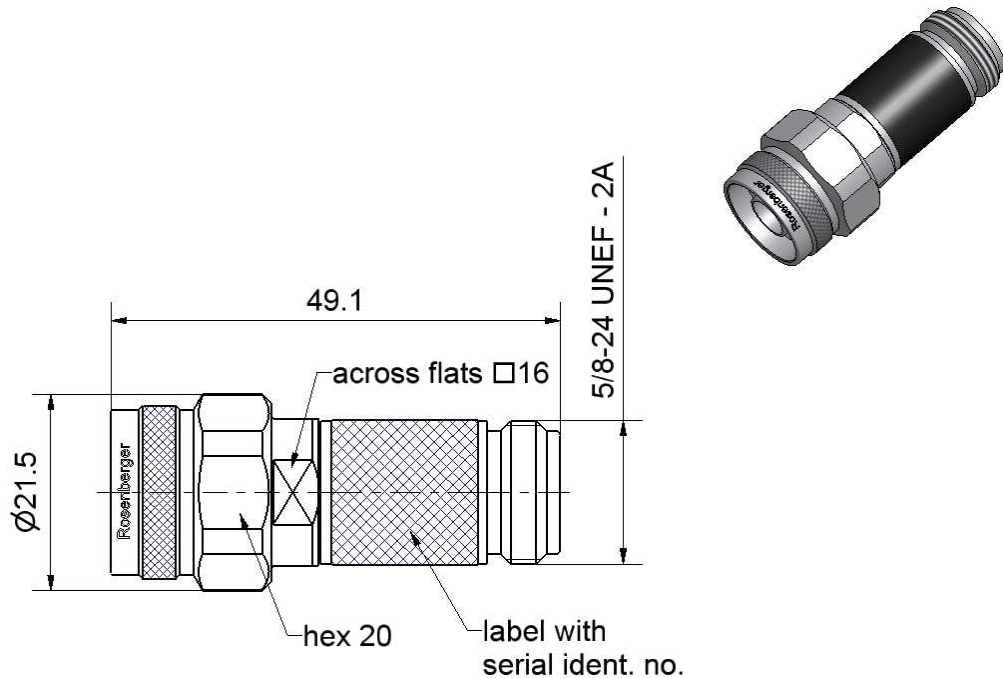

All dimensions are in mm; tolerances according to ISO 2768 m-H

Interface

According to IEC 61169-16

Documents

Application note AN001 "Calibration Services"

Documentation

This Part is delivered with:

- **USB Stick**
 - S2p data file and uncertainty data file of the reference measurement values
 - Calibration Certificate as PDF file.
- **Calibration Certificate**
Details see "Declaration of calibration" options.

Dieses Dokument ist urheberrechtlich geschützt • This document is protected by copyright • Rosenberger Hochfrequenztechnik GmbH & Co. KG

RF_35/09;14/6.2

RPC-N
50 Ω

Attenuator
Plug/Jack

05AS122-K03S3

Material and plating

Connector parts

Center conductor - plug
Center conductor - jack
Outer conductor
Coupling nut
Dielectric
Substrate

Material

Brass
CuBe
Stainless steel
Stainless steel
PPE
Al₂O₃

Plating

Gold, min. 1.27 μm, over nickel
Gold, min. 1.27 μm, over nickel
Passivated
Passivated

Electrical data

Frequency range DC to 18 GHz
DC Resistance 50 Ω
Power handling ≤ 0.5 W

Electrical data (typical)

Return loss ≥ 32 dB, DC to 4 GHz
≥ 26 dB, 4 GHz to 12.4 GHz
≥ 23 dB, 12.4 GHz to 18 GHz
Attenuation 3 dB ± 0.3 dB, DC to 8 GHz
3 dB ± 0.5 dB, 8 GHz to 12.4 GHz
3 dB ± 0.8 dB, 12.4 GHz to 18 GHz

Mechanical data

Mating cycles ≥ 500
Maximum torque 1.70 Nm
Recommended torque 1.10 Nm
Gauge - plug 5.28 mm to 5.32 mm
Gauge - jack 5.22 mm to 5.26 mm

Electrical verification standard

This Attenuator is designed as an electrical verification standard. Reference measurement values (calibration results) for transmission and reflection are included. Connected to a calibrated VNA the actual measured transmission and reflection values can be compared to the reference measurement values and the quality of the VNA calibration can be evaluated.

Environmental data

Operating temperature range¹ +20 °C to +26 °C
Rated temperature range of use² 0 °C to +50 °C
Storage temperature range - 40 °C to +85 °C

RoHS compliant

¹ Temperature range over which the reference measurement values are applicable.

² This range is underneath and above the operating temperature range, within the attenuator is fully functional and could be used without damage.

Dieses Dokument ist urheberrechtlich geschützt • This document is protected by copyright • Rosenberger Hochfrequenztechnik GmbH & Co. KG

RF_35/09;14/6.2

RPC-N
50 Ω

Attenuator
Plug/Jack

05AS122-K03S3

Declaration of calibration options

Factory Calibration

Standard delivery for this verification standard includes a Factory Calibration. The Calibration Certificate issued reports individual transmission and reflection calibration results traceable to national / international standards. A S2p data file with the reference measurement values and the measurement uncertainties in electronic format are included.

Accredited Calibration

Optional this verification standard can be delivered with an Accredited Calibration (DAkkS) having the highest confidence in the traceability. The DAkkS Calibration Certificate issued reports individual transmission and reflection calibration results traceable to national / international standards. A S2p data file with the reference measurement values and the measurement uncertainties in electronic format are included. The measurement uncertainties are smaller than in a Factory Calibration.

For further, more detailed information see application note AN001 on the Rosenberger homepage.

Calibration interval

Recommendation 12 months

Packing

Standard 1 pce in box
Weight 67 g/pce

While the information has been carefully compiled to the best of our knowledge, nothing is intended as representation or warranty on our part and no statement herein shall be construed as recommendation to infringe existing patents. In the effort to improve our products, we reserve the right to make changes judged to be necessary.

Draft	Date	Approved	Date	Rev.	Engineering change number	Name	Date
Marion Striegler	26.01.18	Lars Ramtke	28.03.18	a00	18-0190	Marion Striegler	28.03.18

Rosenberger Hochfrequenztechnik GmbH & Co. KG P.O.Box 1260 D-84526 Tittmoning Germany www.rosenberger.de	Tel. : +49 8684 18-0 Email : info@rosenberger.de	Page 3 / 3
--	---	---------------