



# EVK-R5

## SARA-R5 series cellular evaluation kits

### User guide



#### **Abstract**

This guide explains how to set up the EVK-R5 evaluation kits to begin evaluating the u-blox SARA-R5 series modules supporting multi-band LTE-M / NB-IoT cellular radio access technology and the u-blox's leading GNSS technology.

# Document information

|                               |   |             |
|-------------------------------|---|-------------|
| <b>Title</b>                  | <b>EVK-R5</b>                           |             |
| <b>Subtitle</b>               | SARA-R5 series cellular evaluation kits |             |
| <b>Document type</b>          | User guide                              |             |
| <b>Document number</b>        | UBX-19042592                            |             |
| <b>Revision and date</b>      | R12                                     | 12-Apr-2023 |
| <b>Disclosure restriction</b> | C1-Public                               |             |

| <b>Product status</b>                | <b>Corresponding content status</b> |  |
|--------------------------------------|-------------------------------------|--|
| <b>Functional sample</b>             | Draft                               | For functional testing. Revised and supplementary data will be published later.        |
| <b>In development / Prototype</b>    | Objective specification             | Target values. Revised and supplementary data will be published later.                 |
| <b>Engineering sample</b>            | Advance information                 | Data based on early testing. Revised and supplementary data will be published later.   |
| <b>Initial production</b>            | Early production information        | Data from product verification. Revised and supplementary data may be published later. |
| <b>Mass production / End of life</b> | Production information              | Document contains the final product specification.                                     |

This document applies to the following products:

| <b>Product name</b> | <b>Type number</b> |
|---------------------|--------------------|
| EVK-R500S           | EVK-R500S-1-00     |
|                     | EVK-R500S-6-00     |
|                     | EVK-R500S-7-00     |
| EVK-R510S           | EVK-R510S-1-00     |
|                     | EVK-R510S-6-00     |
|                     | EVK-R510S-7-00     |
| EVK-R510M8S         | EVK-R510M8S-1-00   |
|                     | EVK-R510M8S-6-00   |
|                     | EVK-R510M8S-7-00   |
| EVK-R510AWS         | EVK-R510AWS-01-00  |

u-blox or third parties may hold intellectual property rights in the products, names, logos and designs included in this document. Copying, reproduction, modification or disclosure to third parties of this document or any part thereof is only permitted with the express written permission of u-blox.

The information contained herein is provided "as is" and u-blox assumes no liability for its use. No warranty, either express or implied, is given, including but not limited to, with respect to the accuracy, correctness, reliability and fitness for a particular purpose of the information. This document may be revised by u-blox at any time without notice. For the most recent documents, visit [www.u-blox.com](http://www.u-blox.com).

Copyright © u-blox AG.

# Contents

|  |    |
|--|----|
| Document information .....                                   | 2  |
| Contents .....   | 3  |
| 1 Starting up .....  | 4  |
| Appendix .....   | 14 |
| A Setting up AT terminal communication.....                  | 14 |
| B Setting up cellular packet data connection on Windows..... | 15 |
| C AT commands examples .....                                 | 18 |
| D Current consumption measurement.....                       | 22 |
| E Declaration of conformities.....                           | 23 |
| F Glossary .....   | 24 |
| Related documentation .....                                  | 25 |
| Revision history .....                                       | 25 |
| Contact.....   | 25 |

# 1 Starting up

## 1.1 Overview

The EVK-R5 kit is a powerful and easy-to-use tool that simplifies the evaluation of the u-blox SARA-R5 series LTE-M / NB-IoT cellular modules.

The following evaluation kits are available with u-blox SARA-R5 cellular modules:

- EVK-R500S evaluation kit is for evaluation of SARA-R500S modules, including
  - EVK-R500S-1 evaluation kit for evaluation of SARA-R500S-01B module product version
  - EVK-R500S-6 evaluation kit for evaluation of SARA-R500S-61B module product version
  - EVK-R500S-7 evaluation kit for evaluation of SARA-R500S-71B module product version
- EVK-R510S evaluation kit is for evaluation of SARA-R510S modules, including
  - EVK-R510S-1 evaluation kit for evaluation of SARA-R510S-01B module product version
  - EVK-R510S-6 evaluation kit for evaluation of SARA-R510S-61B module product version
  - EVK-R510S-7 evaluation kit for evaluation of SARA-R510S-71B module product version
- EVK-R510M8S evaluation kit is for evaluation of SARA-R510M8S modules, including
  - EVK-R510M8S-1 evaluation kit for evaluation of SARA-R510M8S-01B module product version
  - EVK-R510M8S-6 evaluation kit for evaluation of SARA-R510M8S-61B module product version
  - EVK-R510M8S-7 evaluation kit for evaluation of SARA-R510M8S-71B module product version
- EVK-R510AWS evaluation kit is for evaluation of SARA-R510AWS-01B module

All evaluation kits are referred to as the EVK-R5, as they are the same in the related variants / versions, except for the specific module product version installed on it, with possible related parts.

The different variants / versions of the EVK-R5 evaluation kit reflect the available variants / versions of the SARA-R5 series modules, including the following 4 modules:

- SARA-R500S, cost effective solution where ultra-low consumption / GNSS are not needed
- SARA-R510S, designed to achieve extremely low current consumption in PSM/eDRX deep-sleep
- SARA-R510M8S, integrating the u-blox M8 high performance concurrent GNSS chip
- SARA-R510AWS, AWS IoT ExpressLink designed to achieve extremely low current consumption in power-off/deep-sleep state

and the following 3 products versions are available for SARA-R500S, SARA-R510S and SARA-R510M8S modules:

- “01B” products version designed for use in multi-regions
- “61B” products version designed for use in Japan
- “71B” products version designed for use in Korea

 See the SARA-R5 series data sheets [\[2\]](#), [\[3\]](#) and the SARA-R5 series system integration manual [\[4\]](#) for features supported by each SARA-R5 series module product version.



## 1.2 Block diagram

Figure 2 shows the main interfaces and internal connections of the EVK-R5 evaluation kit:

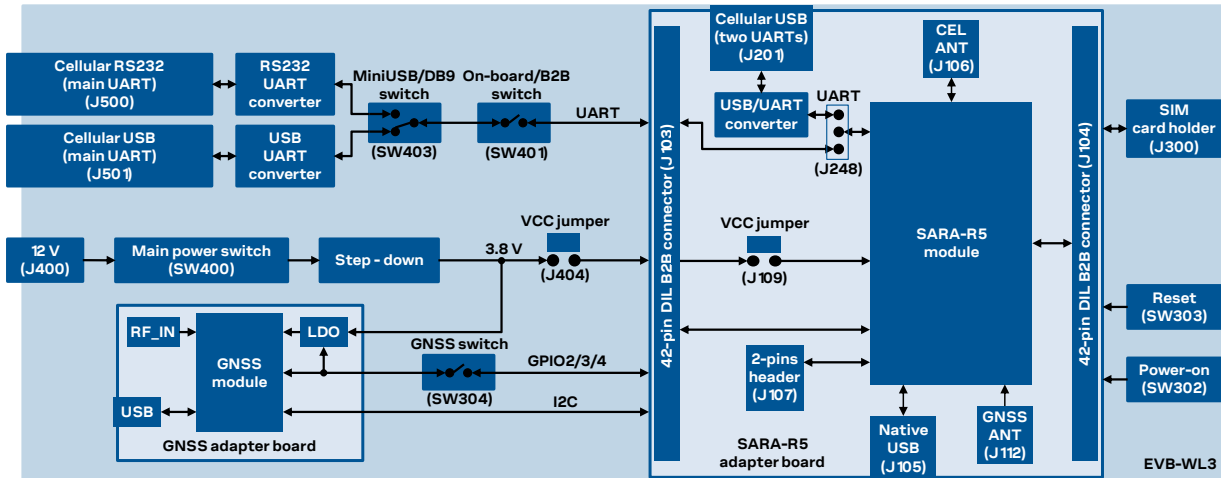

Figure 2: Block diagram of the EVK-R5 for SARA-R5 series modules

The EVK-R5 evaluation kit is formed by three boards:

1. The lower one, called EVB-WL3, contains the power supply and other peripherals for the u-blox SARA-R5 series cellular module (such as SIM card holder, reset button and power-on button).
2. The cellular adapter board, called ADP-R5, contains the u-blox SARA-R5 cellular module and connectors to access the cellular module interfaces. There are antenna connectors for the cellular RF interface and the GNSS RF interface of the cellular module, USB connectors for the two UART interfaces and the USB interface of the cellular module, the DIL header connectors (J103 and J104), and the 2-pins header connector (J107).
3. The GNSS adapter board, called ADP-GNSS, contains the u-blox NEO-M8N GNSS module, the GNSS antenna connector, and the USB connector for the u-blox NEO-M8N GNSS module.

The cellular and the GNSS adapter boards are connected by male header board-to-board connectors provided on the bottom of the adapter boards and their corresponding female connectors provided on top of the EVB-WL3 board.

If the on-board / B2B switch (SW401) on the EVB-WL3 board is set to “on-board” and if a jumper socket is inserted on the pin 1 and pin 2 of the 3-pin header J248 on the cellular adapter board (see Figure 3), then the main UART interface of the cellular module, routed through the DIL header board-to-board connectors mounted on the bottom of the cellular adapter board, can be accessed as converted to USB interface on the USB connector (J501) on the EVB-WL3 board, or it can be accessed as converted to RS232 interface on the RS232 DB9 connector (J500) on the EVB-WL3 board, according to the mini-USB / DB9 switch (SW403) setting.

If the on-board / B2B switch (SW401) on the EVB-WL3 board is set to “B2B” and if a jumper socket is inserted on the pin 2 and pin 3 of the 3-pin header cellular UART jumper (J248) on the adapter board (illustrated in Figure 3), the UART interfaces of SARA-R5 series module can be accessed as USB interfaces on the USB connector (J201) on the cellular adapter board.

If the on-board / B2B switch (SW401) on the EVB-WL3 board is set to “B2B” and if there is no jumper socket inserted on the 3-pin header J248 on the cellular adapter board (illustrated in Figure 3), then the UART interface(s) of the SARA-R5 module can be accessed at 1.8 V CMOS signal levels on the DIL header connector mounted on the top of the cellular adapter board, to communicate, for example, with an external MCU.

The USB interface of the cellular module (available for diagnostic purpose only) is available on the native USB connector (J105) mounted on the cellular adapter board.

Other SARA-R5 series peripherals are available on the dual-in-line male board-to-board connectors (J103, and J104) and the 2-pins header connector (J107) provided on the top layer of the cellular adapter board.

The lower board (EVB-WL3) is also designed to be used with other u-blox cellular adapter boards. It contains additional switches, jumpers, connectors, LEDs and parts that may be only partially described in [Figure 1](#) or in this document, because they are intended for use only with other u-blox cellular modules. It is recommended to leave any additional connector unconnected and any additional switch in its default configuration.

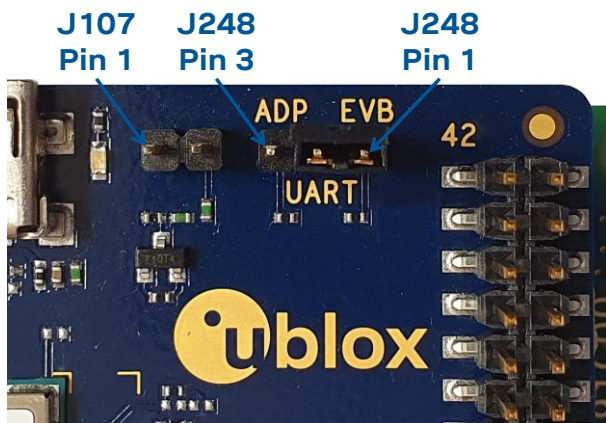

Figure 3: 3-pin header J248 available to set the routing of the UART interfaces on the EVK for SARA-R5 series modules















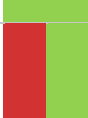



### 1.3 Switches, jumpers, and buttons

| Function                          | Description   | Name  | Board   |
|-----------------------------------|---|-------|---------|
| Main power switch                 | Power on / off the whole evaluation kit   | SW400 | EVB-WL3 |
| Cellular VCC jumper               | Jumper socket to provide the 3.8 V supply to the cellular module VCC input  | J404  | EVB-WL3 |
|                                   |   | J109  | ADP-R5  |
| Cellular power on                 | Push button to switch on / off the cellular module  | SW302 | EVB-WL3 |
| Cellular reset                    | Push button to reset the cellular module  | SW303 | EVB-WL3 |
| Cellular UART detach              | Slide switch to attach / detach the cellular module main UART from the USB / RS232 connectors on EVB-WL3  | SW401 | EVB-WL3 |
| Cellular UART routing             | Slide switch to select cellular module main UART routing on the USB or RS232 connector on EVB-WL3   | SW403 | EVB-WL3 |
| Cellular UART routing             | 3-pin header to route and make accessible the UART(s) of SARA-R5 series over the USB connector on the ADP board, or over the USB or RS232 connectors on the EVB-WL3, or over the DIL B2B connector on the ADP board | J248  | ADP-R5  |
| Cellular GPIO detach              | Slide switch to attach / detach the cellular module GPIOs from peripherals: when detached, the signals are available only on the DIL B2B connector on the ADP board   | SW300 | EVB-WL3 |
| Cellular GNSS detach <sup>1</sup> | Slide switch to attach / detach the cellular module to / from the GNSS module (GPIO2-3-4): when detached, the signals are available only on the DIL B2B connector on the ADP board                                  | SW304 | EVB-WL3 |
| GNSS V_BCKP                       | Slide switch to connect / disconnect backup battery to / from the V_BCKP pin of the GNSS module   | SW204 | EVB-WL3 |

Table 1: EVK-R5 switch and button descriptions

<sup>1</sup> For EVK-R510M8S it is recommended to keep this switch in “detach” position.

## 1.4 LEDs

| Function                         | Description   | LED # | Board    | Color   |
|----------------------------------|---|-------|----------|---|
| Main power                       | Power supply plugged in the <b>9 - 18 V Power Input</b>   | DL401 | EVB-WL3  |    |
| Cellular VCC                     | Cellular module supplied. <b>Main power switch</b> must be switched on.   | DL400 | EVB-WL3  |    |
| Cellular USB (main UART)         | USB cable plugged in the <b>Cellular USB</b> connector (J501) for access to the main UART interface of the cellular module  | DL501 | EVB-WL3  |    |
| Cellular USB (main UART)         | Green light is on when the SW401 is in “on-board” position, and when the cellular module main UART is routed to the <b>Cellular USB</b> connector. Red light blinks at UART TX or RX data on the <b>Cellular USB</b> connector. | DL403 | EVB-WL3  |    |
| Cellular main UART attach/detach | UART signals of the cellular module are available only on the ADP board.  | DL404 | EVB-WL3  |    |
| Cellular RS232 (main UART)       | Green light is on when the main UART of the cellular module is routed to the <b>Cellular RS232</b> connector (J500). Red light blinks at UART TX or RX data on the <b>Cellular RS232</b> connector.                             | DL405 | EVB-WL3  |    |
| Cellular RI indicator            | RI line turns ON (active low)   | DS501 | EVB-WL3  |    |
| Cellular CTS indicator           | CTS line turns ON (active low)  | DS500 | EVB-WL3  |    |
| Cellular GPIO1 indicator         | Green light is activated when cellular GPIO1 is high  | DS107 | EVB-WL3  |    |
| Cellular GPIO2 indicator         | Green light is activated when cellular GPIO2 is high  | DS105 | EVB-WL3  |    |
| Cellular GPIO3 indicator         | Green light is activated when cellular GPIO3 is high  | DS109 | EVB-WL3  |    |
| Cellular GPIO4 indicator         | Green light is activated when cellular GPIO4 is high  | DS103 | EVB-WL3  |    |
| Cellular GPIO6 indicator         | Green light is activated when cellular GPIO6 is high, e.g., to be used for time pulse function  | DS139 | ADP-R5   |   |
| Cellular native USB              | USB cable plugged in the <b>Cellular native USB</b> connector (J105) on the ADP-R5, for access to the cellular USB interface  | DS100 | ADP-R5   |  |
| Cellular USB (two UARTs)         | USB cable plugged in the <b>Cellular USB</b> connector (J201) on the ADP-R5, for access to the two UART interfaces  | DS201 | ADP-R5   |  |
| GNSS VCC supply                  | NEO-M8N GNSS module supply is turned on   | DS118 | ADP-GNSS |  |
| GNSS USB                         | USB cable plugged into the <b>GNSS USB</b> connector for NEO-M8N  | DS124 | ADP-GNSS |  |
| NEO GNSS time pulse              | NEO-M8N GNSS TimePulse output   | DS121 | ADP-GNSS |  |
| Cellular / GNSS I2C              | Cellular / GNSS module communication over the I2C interface   | DS132 | ADP-GNSS |  |



**Table 2: EVK-R5 LED descriptions**



## 1.5 Connectors

| Function                           | Description  |   | Name                                 | Board                    |          |
|------------------------------------|--|---|--------------------------------------|--------------------------|----------|
| 9 - 18 V power input               | Connector for the AC / DC power adapter of EVK<br>AC: 100-240 V, 0.8 A, 50-60 Hz / DC: +12 V, 2.5 A              |  | IEC 60417-5172<br>Class II equipment | J400                     | EVB-WL3  |
| SIM card holder                    | SIM card holder  |   |                                      | J300                     | EVB-WL3  |
| Cellular USB<br>(main UART)        | Mini-USB connector for the cellular module main UART interface converted<br>as a USB interface                   |   |                                      | J501                     | EVB-WL3  |
| Cellular RS232<br>(main UART)      | DB9 connector for the cellular module main UART interface converted as an<br>RS232 interface                     |   |                                      | J500                     | EVB-WL3  |
| GNSS backup battery                | Backup battery socket for the GNSS module (under GNSS adapter board)   |   |                                      | BT200                    | EVB-WL3  |
| GND                                | Ground terminals for the probe reference   |   |                                      | J402, J403<br>J405, J406 | EVB-WL3  |
| Cellular antenna                   | SMA connector for the module cellular antenna (ANT)  |   |                                      | J106                     | ADP-R5   |
| GNSS antenna<br>(for SARA-R510M8S) | SMA connector for the GNSS antenna to be connected to the GNSS RF<br>input of the SARA-R510M8S module (ANT_GNSS) |   |                                      | J112                     | ADP-R5   |
| Cellular native USB                | Mini-USB connector for the cellular module native USB interface  |   |                                      | J105                     | ADP-R5   |
| Cellular USB<br>(two UARTs)        | Mini-USB connector for the cellular module two UART interfaces converted<br>as USB interfaces                    |   |                                      | J201                     | ADP-R5   |
| DIL B2B headers                    | Dual-in-line board-to-board connectors for cellular module interfaces  |   |                                      | J103, J104               | ADP-R5   |
| 2-pin header                       | Header providing access to EXT_INT and V_INT pins of the cellular module   |   |                                      | J107                     | ADP-R5   |
| GNSS antenna<br>(for NEO-M8N)      | SMA connector for the GNSS antenna to be connected to the GNSS RF<br>input of the NEO-M8N GNSS module (RF_IN)    |   |                                      | J208                     | ADP-GNSS |
| GNSS USB                           | Mini-USB connector for the GNSS module USB interface   |   |                                      | J102                     | ADP-GNSS |

**Table 3: EVK-R5 connector descriptions**

-  Caution! In the unlikely event of a failure in the internal protection circuitry, there is a risk of an explosion when charging a fully or a partially discharged battery. Replace the battery when it no longer has sufficient charge for unit operation. Check the battery before use if the device has not been used for an extended period.
-  Caution! Risk of explosion if the battery is replaced with an incorrect type. Dispose of used batteries according to the instructions.

## 1.6 Pin out

Table 4 lists the interfaces of the SARA-R5 series modules, as routed up to the 42-pin dual-in-line board-to-board connectors J103 and J104, the 2-pin header connector J107, the mini USB connector J105, the micro SD card connector J203 or the SMA connectors J106 and J112 available on the ADP-R5 adapter board of the evaluation kit.

| SARA-R5 module |             |                             | SARA-R5 module |             |                             |
|----------------|-------------|-----------------------------|----------------|-------------|-----------------------------|
| Pin no.        | Signal name | Connector Name / pin number | Pin no.        | Signal name | Connector Name / pin number |
| 1              | GND         | J104 pins 7-10              | 33             | EXT_INT     | J107 pin 2                  |
| 2              | RSVD        | J104 pin 4                  | 34             | I2S_WA      | J103 pin 26                 |
| 3              | GND         | J104 pins 7-10              | 35             | I2S_TXD     | J103 pin 23                 |
| 4              | V_INT       | J104 pin 35, J107 pin 1     | 36             | I2S_CLK     | J103 pin 21                 |
| 5              | GND         | J104 pins 7-10              | 37             | I2S_RXD     | J103 pin 24                 |
| 6              | DSR         | J104 pin 17                 | 38             | SIM_CLK     | J103 pin 16                 |
| 7              | RI          | J104 pin 18                 | 39             | SIM_IO      | J103 pin 13                 |
| 8              | DCD         | J104 pin 12                 | 40             | SIM_RST     | J103 pin 15                 |
| 9              | DTR         | J104 pin 11                 | 41             | VSIM        | J103 pin 14                 |
| 10             | RTS         | J104 pin 14                 | 42             | GPIO5       | J104 pin 24                 |
| 11             | CTS         | J104 pin 13                 | 43             | GND         | J104 pins 7-10              |
| 12             | TXD         | J104 pin 16                 | 44             | SDIO_D2     | J203 pin 1                  |
| 13             | RXD         | J104 pin 15                 | 45             | SDIO_CLK    | J203 pin 5                  |
| 14             | GND         | J104 pins 7-10              | 46             | SDIO_CMD    | J203 pin 3                  |
| 15             | PWR_ON      | J104 pin 30                 | 47             | SDIO_D0     | J203 pin 7                  |
| 16             | GPIO1       | J104 pin 34                 | 48             | SDIO_D3     | J203 pin 2                  |
| 17             | VUSB_DET    | J105 pin 1                  | 49             | SDIO_D1     | J203 pin 8                  |
| 18             | RESET_N     | J103 pin 25                 | 50             | GND         | J104 pins 7-10              |
| 19             | GPIO6       | J104 pin 23                 | 51             | VCC         | J103 pins 7-10              |
| 20             | GND         | J104 pins 7-10              | 52             | VCC         | J103 pins 7-10              |
| 21             | ADC         | J104 pin 22                 | 53             | VCC         | J103 pins 7-10              |
| 22             | GND         | J104 pins 7-10              | 54             | GND         | J104 pins 7-10              |
| 23             | GPIO2       | J104 pin 32                 | 55             | GND         | J104 pins 7-10              |
| 24             | GPIO3       | J104 pin 31                 | 56             | ANT         | J106 pin 1                  |
| 25             | GPIO4       | J104 pin 26                 | 57             | GND         | J104 pins 7-10              |
| 26             | SDA         | J103 pin 22                 | 58             | GND         | J104 pins 7-10              |
| 27             | SCL         | J103 pin 19                 | 59             | GND         | J104 pins 7-10              |
| 28             | USB_D-      | J105 pin 2                  | 60             | GND         | J104 pins 7-10              |
| 29             | USB_D+      | J105 pin 3                  | 61             | GND         | J104 pins 7-10              |
| 30             | GND         | J104 pins 7-10              | 62             | ANT_DET     | J106 pin 1                  |
| 31             | ANT_GNSS    | J112 pin 1                  | 63             | GND         | J104 pins 7-10              |
| 32             | GND         | J104 pins 7-10              | 64             | GND         | J104 pins 7-10              |

Table 4: Interfaces of the SARA-R5 series modules

| Dual-In-Line Board-to-Board connector J104 |         |         |               | Dual-In-Line Board-to-Board connector J103 |         |         |               |
|--|---------|---------|---------------|--|---------|---------|---------------|
| Signal name                                | Pin no. | Pin no. | Signal name   | Signal name                                | Pin no. | Pin no. | Signal name   |
| Not connected                              | 1       | 2       | GND           | Not connected                              | 1       | 2       | GND           |
| Not connected                              | 3       | 4       | RSVD          | Not connected                              | 3       | 4       | Not connected |
| Not connected                              | 5       | 6       | Not connected | Not connected                              | 5       | 6       | Not connected |
| GND  | 7       | 8       | GND           | VCC  | 7       | 8       | VCC           |
| GND  | 9       | 10      | GND           | VCC  | 9       | 10      | VCC           |
| DTR  | 11      | 12      | DCD           | Not connected                              | 11      | 12      | Not connected |
| CTS  | 13      | 14      | RTS           | SIM_IO                                     | 13      | 14      | VSIM          |
| RXD  | 15      | 16      | TXD           | SIM_RST                                    | 15      | 16      | SIM_CLK       |
| DSR  | 17      | 18      | RI            | Not connected                              | 17      | 18      | Not connected |
| Not connected                              | 19      | 20      | Not connected | SCL  | 19      | 20      | Not connected |
| Not connected                              | 21      | 22      | ADC           | I2S_CLK                                    | 21      | 22      | SDA           |
| GPIO6                                      | 23      | 24      | GPIO5         | I2S_TXD                                    | 23      | 24      | I2S_RXD       |
| Not connected                              | 25      | 26      | GPIO4         | RESET_N                                    | 25      | 26      | I2S_WA        |
| Not connected                              | 27      | 28      | Not connected | Not connected                              | 27      | 28      | Not connected |
| Not connected                              | 29      | 30      | PWR_ON        | Not connected                              | 29      | 30      | Not connected |
| GPIO3                                      | 31      | 32      | GPIO2         | Not connected                              | 31      | 32      | Not connected |
| Not connected                              | 33      | 34      | GPIO1         | Not connected                              | 33      | 34      | Not connected |
| V_INT                                      | 35      | 36      | Not connected | Not connected                              | 35      | 36      | Not connected |
| Not connected                              | 37      | 38      | Not connected | Not connected                              | 37      | 38      | Not connected |
| Not connected                              | 39      | 40      | Not connected | Not connected                              | 39      | 40      | Not connected |
| GND  | 41      | 42      | Not connected | GND  | 41      | 42      | Not connected |

**Table 5: Pin-out of the 42-pin dual-in-line board-to-board connectors (J103, J104) on the ADP-R5 adapter board of the evaluation kit**

 The pins / interfaces that are not supported by a specific SARA-R5 module product version should be not driven by an external device. (See the SARA-R5 series data sheets [2], [3] and the SARA-R5 series system integration manual [4] to learn about the features supported by each SARA-R5 module product version.)

## 1.7 Board setup

1. Insert a SIM card into the **SIM card holder** (J300 on the EVB-WL3).
2. Connect the cellular antenna provided with the evaluation kit box to the **Cellular antenna SMA** connector on the ADP-R5 (ANT connector for transmission and reception of LTE RF signals).
3. If the GNSS functionality is required:
  - 3.1. For the EVK-R500S and EVK-R510S, connect the GNSS antenna provided with the evaluation kit box to the **GNSS antenna SMA** connector on the ADP-GNSS (J208); keep cellular GNSS detach switch (SW304) in “GNSS” position.
  - 3.2. For the EVK-R510M8S, connect the GNSS antenna provided with the evaluation kit box to the **GNSS antenna SMA** connector on the ADP-R510M8S (J112); keep cellular GNSS detach switch (SW304) in “detach” position.

Place the GNSS antenna in a location with a good view of the sky.

4. Connect the AC / DC +12 V power adapter provided with the evaluation kit box to the **9 – 18 V power input** connector (J400 on the EVB-WL3). The LED DL401 lights blue.
5. Be sure to provide a jumper socket on both the **Cellular VCC supply jumpers** (J404 on the EVB-WL3, and J109 on the ADP-R5). These jumpers provide the connection from the 3.8 V output of the supply circuit on the EVB-WL3 to the VCC input of the module.
6. To enable the board power supply, turn the **Main power switch** (SW400 on the EVB-WL3) to the ON position. The LED DL400 lights green.
  - 6.1. For the EVK-R510S and EVK-R510AWS, press the **Cellular power-on** button (SW302 on the EVB-WL3) to switch on the cellular module.
  - 6.2. For the EVK-R500S, the SARA-R500S cellular module switches on. For the EVK-R510M8S, the SARA-R510M8S cellular module switches on.
7. For communication via the cellular module’s UART interface, the following connections are allowed and can be alternatively enabled in a mutually exclusive way (see [Table 6](#) for the switch position and LED status):
  - 7.1. Connect a USB cable to the mini-USB connector on EVB-WL3 (**Cellular USB**, J501). The LED DL501 lights blue. When a USB cable is connected to this mini-USB connector, two COM ports are enabled in Windows: the main UART interface of the cellular module is available over the first COM port opened by the driver.
  - 7.2. Connect an RS232 cable to the DB9 connector on EVB-WL3 (**Cellular RS232**, J500).
  - 7.3. Connect a USB cable to the mini-USB connector on ADP-R5 (**Cellular USB**, J201). The LED DS201 lights blue. When a USB cable is connected to this mini-USB connector, two COM ports are enabled in Windows: the two UART interfaces<sup>2</sup> of the cellular module are respectively available over the two numbered COM ports opened by the driver (to enable two UART interfaces, see the AT commands manual [\[1\]](#), the +USIO AT command).

---

<sup>2</sup> Not supported on EVK-R510AWS

| Type of connections   | SW401    | SW403       | J248                      | LED            |
|---|----------|-------------|---------------------------|----------------|
| Access to the main UART interface over the <b>Cellular USB</b> mini-USB connector on EVB-WL3 (J501)             | ON BOARD | MINIUSB     | Jumper socket on pins 1-2 | DL403<br>DL501 |
| Access to the main UART interface over the <b>Cellular RS232</b> DB9 connector on EVB-WL3 (J500)                | ON BOARD | DB9         | Jumper socket on pins 1-2 | DL405          |
| Access to the two UART interfaces <sup>3</sup> over the <b>Cellular USB</b> mini-USB connector on ADP-R5 (J201) | B2B      | Do not care | Jumper socket on pins 2-3 | DL404<br>DS201 |
| Access to UART(s) interface(s) over the <b>DIL B2B header</b> on the top of the adapter board (J104)            | B2B      | Do not care | No jumper socket          | DL404          |

**Table 6: Serial interface configuration**

 See the SARA-R5 series data sheet [2] and the +USIO AT command description in the SARA-R5 series AT commands manual [1] for the description and configuration of the USIO variants.

Run an AT terminal application (e.g. the u-blox m-center tool) and select an AT port with these settings:

- Data rate: 115,200 bit/s
- Data bits: 8
- Parity: N
- Stop bits: 1
- Flow control: HW for EVK-R500S, EVK-R510S and EVK-R510M8S  
none for EVK-R510AWS

See Appendix A for how to configure the u-blox m-center AT terminal for Windows.

8. To switch off the EVK-R500S, EVK-R510S and EVK-R510M8S, send the +CPWROFF AT command. To switch off the EVK-R510AWS, send the AT+SLEEP9 command. Make sure to use this command before switching off the main power, otherwise settings and configuration parameters may not be saved in the internal non-volatile memory of the cellular module.

<sup>3</sup> Not supported on EVK-R510AWS

# Appendix

## A Setting up AT terminal communication

The u-blox m-center cellular module evaluation tool is a powerful platform for evaluating, configuring and testing u-blox cellular products. m-center includes an AT commands terminal for communication with the device and can be downloaded free-of-charge from our website (<http://www.u-blox.com>). For m-center example scripts, visit <https://github.com/u-blox/m-center>.

1. Follow the board setup instructions in section 1.7 to provide all the required connections and switching on the cellular module.
2. Run the m-center tool: after the m-center start-up, the **Home** page appears.
3. On the **Home** page, set up the AT COM port with the setting values described in section 1.7. Check the Windows Device Manager to find out which COM port is being used by the EVK-R5.
4. Enable the connection to the u-blox cellular module by clicking the **Connect** button.
5. Retrieve the module and network information by clicking the **Get info** button.
6. The module information is retrieved and displayed on the **Home** page.
7. Click on the **AT Terminal** button (upper right of the **Home** page). A new window opens and the AT command terminal is now ready for communication with EVK-R5.
8. The AT terminal is ready to use.

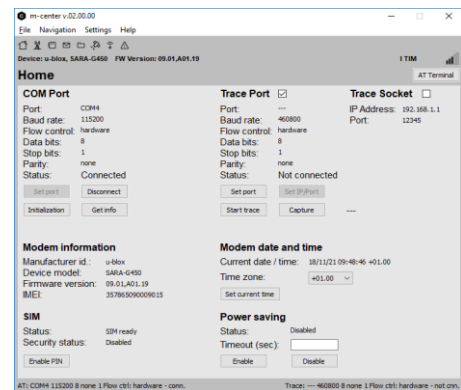

Figure 4: “Home” page

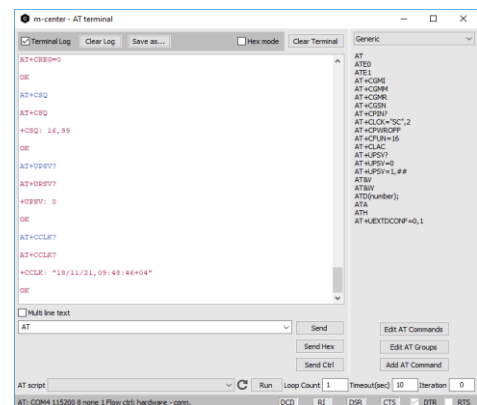

Figure 5: AT terminal window

For the complete list of the AT commands supported by the modules and their syntax, see the SARA-R5 series AT commands manual [1], the SARA-R510AWS application development guide [6] and the AWS IoT ExpressLink programmer’s guide [7].

For more information about using the u-blox m-center cellular module evaluation tool, press the F1 key on the keyboard to open the m-center help window on the computer.

## B Setting up cellular packet data connection on Windows

This section does not apply to EVK-R510AWS.

This section describes how to set up a packet data connection on Windows 10 using the operating system's TCP/IP stack and EVK-R5. This is also referred to as a dial-up connection.

### B.1 Install a new modem from the control panel

1. Open the Control Panel and select "Phone and Modem", go to the Modems tab and select "Add".

This opens the Add Hardware Wizard.

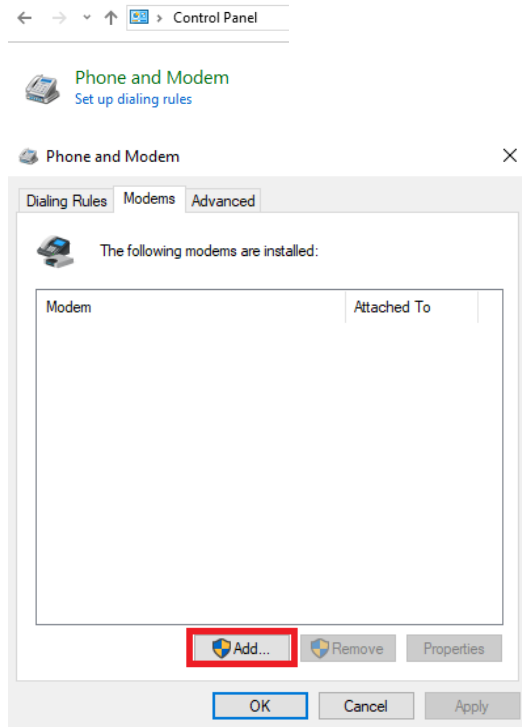

2. Tick the "Don't detect my modem" checkbox. Then select "Next".

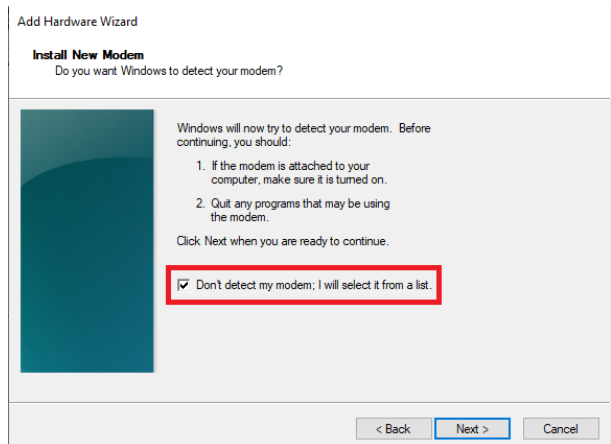

3. Select “Standard 33600 bps Modem” and click “Next”.

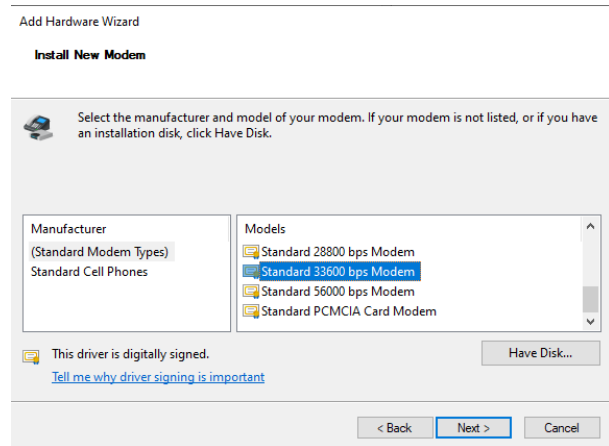

4. Select the COM port to use for data communication and click “Next”. This is the COM port on which the modem will be installed.
5. In the next step, click “Finish” to complete the modem installation.

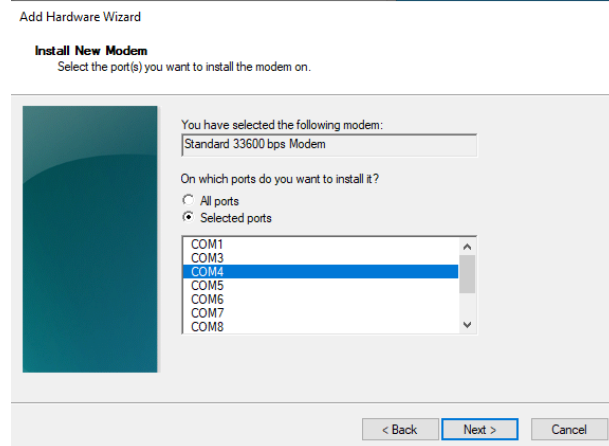

6. Now the new modem is visible under the Modems tab in Control Panel > Phone and Modem.

Any extra initialization AT command (e.g., to set a specific APN name) can be entered by selecting Properties and filling in the “Extra initialization commands” text box under the Advanced tab.

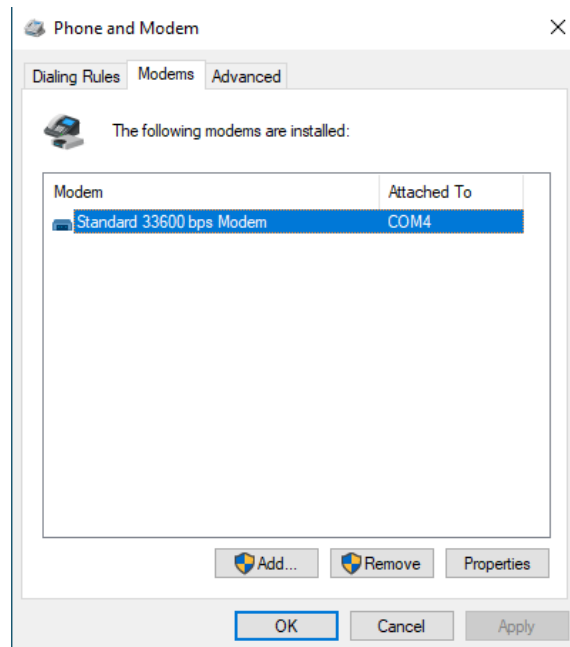

Now the module is ready and the connection can be configured.

The modem configuration can also be edited by clicking on the modem name in the Device Manager.



## B.2 Configuring a new connection

1. Open the Control Panel, go to the Network and Sharing Center, and select “Set up a new connection or network”.

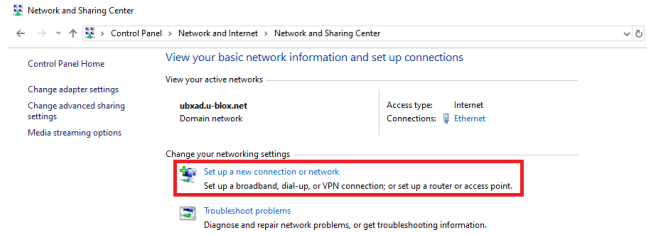

2. Select “Connect to the Internet” and click “Next”.

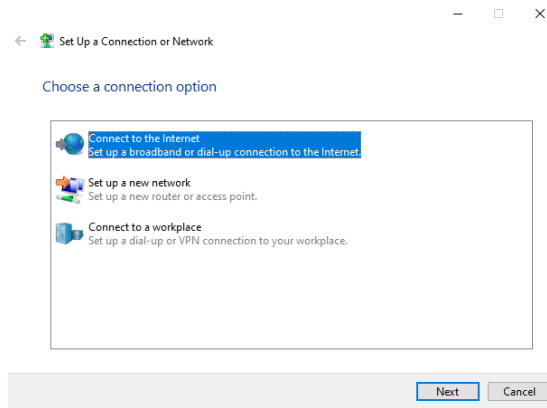

3. Select “Dial-up” and, if requested, the modem previously installed.

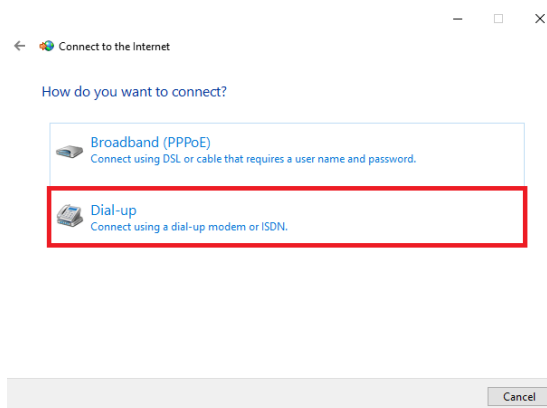

4. Enter the parameters for the dial-up connection:
  - The module telephone number:  
\*99\*\*\*1#  
(change if using a PDP context different from 1)
  - The specific account information for the network operator
  - A name for the connection (e.g., “R5 Dial-up”)

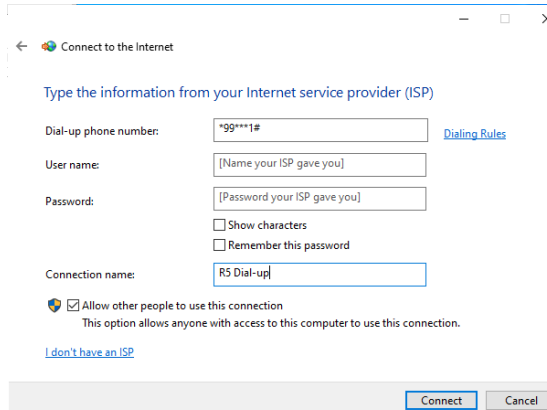

The packet data connection is now ready to be used with EVK-R5. Click “Connect” to start the connection, then start a browser to check internet connectivity.

Consult the cellular network operator for username and password. In most cases, they can be left empty.

## C AT commands examples

 This section does not apply to EVK-R510AWS. For further details on SARA-R510AWS modules AT commands, see the SARA-R510AWS application development guide [6] and the AWS IoT ExpressLink programmer's guide [7].

For the complete description and syntax of the AT commands supported by SARA-R5 series modules, see the SARA-R5 series AT commands manual [1].

For detailed AT commands examples for network registration and configuration, context activation, data connection management, SIM management, module interfaces configurations and other settings, see the u-blox SARA-R5 application development guide [5].

### C.1 Define the initial default bearer for connectivity

To change the PDN settings for the initial default EPS bearer established during LTE attach, edit the <cid>=1 PDN by means of the +CGDCONT AT command.

| Command sent by DTE (user)        | DCE response (module)   | Description   |
|-----------------------------------|---|---|
| AT+COPS?                          | +COPS: 2<br>OK  | The module is not registered.   |
| AT+CEREG=2;+CGEREP=1,1            | OK  | Enable a set of registration URCs.  |
| AT+CGDCONT?                       | +CGDCONT: 1,"IPV4V6","", "0.0.0.0<br>0.0.0.0.0.0.0.0.0.0.0.0.0.0.0.0",<br>0,0,0,2,0,0,0,0,0<br>OK | Read IP type and APN for EPS attach bearer.   |
| AT+CGDCONT=1,"IPV4V6","broadband" | OK  | Set the APN name ("broadband" for example) and the PDP type ("IPV4V6" for example) for EPS attach bearer. |
| AT+COPS=0                         | OK<br><br>+CEREG: 1,"0001","01a2d001",7<br>+CGEV: ME PDN ACT 1                                    | Trigger a network registration and wait for attach complete.  |

### C.2 Data connection using internal TCP/IP stack

Activate an internal context to use the internal TCP/UDP stack.

If an external "IP" context is active, just map the external context to an internal one.

| Command sent by DTE (user) | DCE response (module)   | Description   |
|----------------------------|---|---|
| AT+CGDCONT?                | +CGDCONT: 1,"IP","default.mnc321.mcc654.gprs", "192.168.20.6",0,0,0<br>,2,0,0,0,0,0,0<br>OK   | Read IP type and APN for EPS attach bearer.<br>Context <cid>=1 has IP type "IP" and APN "default.mnc321.mcc654.gprs".   |
| AT+CGCONTRDP=1             | +CGCONTRDP: 1,5,"default.mnc321.mcc654.gprs", "192.168.20.6.255.255.255.0", "192.168.20.1", "185.215.195.114", "", "", "", 0,0,1500,0,0<br>OK | Read context <cid>=1 dynamic parameters.<br><cid>=1 is currently active with IPv4 address 192.168.20.6/24, gateway 192.168.20.1 and DNS server 185.215.195.114. |
| AT+UPSDA=0,100,1           | OK  | Map external context <cid>=1 to internal context <profile_id>=0.  |
| AT+UPSDA=0,3               | OK<br>+UUPSDA: 0,"192.168.20.6"   | Activate internal context <profile_id>=0. A URC is received indicating activation complete and IPv4 address for the internal context.                           |

When an external context is mapped to an internal PSD profile, make sure that the same protocol type (IP/IPV6/IPV4V6) is set both for the context and the profile, before the PSD profile is activated.

On SARA-R5 products the default protocol type for external contexts is IPV4V6, while for internal PSD profiles is IP(v4).

| Command sent by DTE (user)                       | DCE response (module) | Description  |
|--|-----------------------|--|
| <b>Map a context with protocol type "IP"</b>     |                       |  |
| AT+CGDCONT=1,"IP","default"                      | OK                    | Set context <cid>=1 with "IP" protocol type and APN string "default".  |
| <wait for context <cid>=1 activation>            |                       |  |
| AT+UPSD=0,100,1                                  | OK                    | Map external context <cid>=1 to internal context <profile_id>=0.   |
| AT+UPSD=0,0,0                                    | OK                    | Set protocol type for internal context <profile_id>=0 to IPv4.   |
| AT+UPSDA=0,3                                     | OK                    | Activate internal context <profile_id>=0.  |
| <b>Map a context with protocol type "IPV6"</b>   |                       |  |
| AT+CGDCONT=1,"IPV6","default"                    | OK                    | Set context <cid>=1 with "IPV6" protocol type and APN string "default".  |
| <wait for context <cid>=1 activation>            |                       |  |
| AT+UPSD=0,100,1                                  | OK                    | Map external context <cid>=1 to internal context <profile_id>=0.   |
| AT+UPSD=0,0,1                                    | OK                    | Set protocol type for internal context <profile_id>=0 to IPv6.   |
| AT+UPSDA=0,3                                     | OK                    | Activate internal context <profile_id>=0.  |
| <b>Map a context with protocol type "IPV4V6"</b> |                       |  |
| AT+CGDCONT=1,"IPV4V6","default"                  | OK                    | Set context <cid>=1 with "IPV4V6" protocol type and APN string "default".  |
| <wait for context <cid>=1 activation>            |                       |  |
| AT+UPSD=0,100,1                                  | OK                    | Map external context <cid>=1 to internal context <profile_id>=0.   |
| AT+UPSD=0,0,2                                    | OK                    | Set protocol type for internal context <profile_id>=0 to IPv4v6 with IPv4 preferred. Alternatively, AT+UPSD=0,0,3 can be used. |
| AT+UPSDA=0,3                                     | OK                    | Activate internal context <profile_id>=0.  |

### C.3 Opening a TCP socket

| Command sent by DTE (user) | DCE response (module) | Description   |
|----------------------------|-----------------------|---|
| AT+CMEE=2                  | OK                    | Enables the cellular module to report verbose error result codes. |
| AT+CGATT?                  | +CGATT: 1<br>OK       | Verifies the SARA-R5 module is attached to the network.           |
| AT+CEREG?                  | +CEREG: 0,1<br>OK     | Verify the network registration status.                           |

| Command sent by DTE (user)     | DCE response (module)                               | Description   |
|--------------------------------|---|---|
| AT+COPS=0                      | OK  | Register the module on the network.<br>The cellular module automatically registers itself on the cellular network. This command is necessary only if the automatic registration failed (AT+CREG? returns 0,0).<br> The AT+COPS=0 command is strictly necessary only if the module starts up with auto-cops disabled, that is, +COPS: 2 setting stored in the profiles per design (AT&V). |
| AT+COPS?                       | +COPS: 0,0,"Verizon Wireless",7<br>OK               | Read the operator name and radio access technology (RAT).   |
| AT+UPSND=0,8                   | +UPSND: 0,8,1<br>OK                                 | Check internal context <profile_id>=0 status.<br>The PSD profile is active.   |
| AT+USOCR=6                     | +USOCR: 0<br>OK                                     | Create a TCP socket.  |
| AT+USOCO=0,"185.215.195.137",7 | OK  | Connect to the server.  |
|                                | +UUSORD: 0,32                                       | Greeting message.   |
| AT+USORD=0,32                  | +USORD: 0,32,"u-blox AG TCP/UDP test service"<br>OK | Retrieving the message.   |
| AT+USOCL=0                     | OK  | Closing the socket.   |

## C.4 Opening a UDP socket

| Command sent by DTE (user)                        | DCE response (module)                 | Description   |
|---|---------------------------------------|---|
| AT+CMEE=2   | OK                                    | Enables the cellular module to report verbose error result codes.   |
| AT+CGATT?   | +CGATT: 1<br>OK                       | Verifies the SARA-R5 module is attached to the network.   |
| AT+CEREG?   | +CEREG: 0,1<br>OK                     | Verify the network registration status.   |
| AT+COPS=0   | OK                                    | Register the module on the network.<br>The cellular module automatically registers itself on the cellular network. This command is necessary only if the automatic registration failed (AT+CREG? returns 0,0).<br> The AT+COPS=0 command is strictly necessary only if the module starts up with auto-cops disabled, that is, +COPS: 2 setting stored in the profiles per design (AT&V). |
| AT+COPS?  | +COPS: 0,0,"Verizon Wireless",7<br>OK | Read the operator name and radio access technology (RAT).   |
| AT+UPSND=0,8                                      | +UPSND: 0,8,1<br>OK                   | Check internal context <profile_id>=0 status.<br>The PSD profile is active.   |
| AT+USOCR=17                                       | +USOCR: 0<br>OK                       | Create a UDP socket.  |
| AT+USOST=0,"185.215.195.137",7,13,"TestNumberOne" | +USOST: 0,13<br>OK                    | Connecting and storing text on the server.  |
|   | +UUSORF: 0,13                         | Echo server returning the message.  |

| Command sent by DTE (user) | DCE response (module)                                      | Description                          |
|----------------------------|--|--------------------------------------|
| AT+USORF=0,13              | +USORF: 0,"185.215.195.137",7,13,<br>"TestNumberOne"<br>OK | Reading the message from the server. |
| AT+USOCL=0                 | OK   | Closing the socket.                  |

## D Current consumption measurement

The current consumption of SARA-R5 modules can be measured on the EVK-R5 by removing the jumper socket from the **Cellular VCC supply jumper J109** on the ADP-R5 board, as shown in [Figure 6](#).

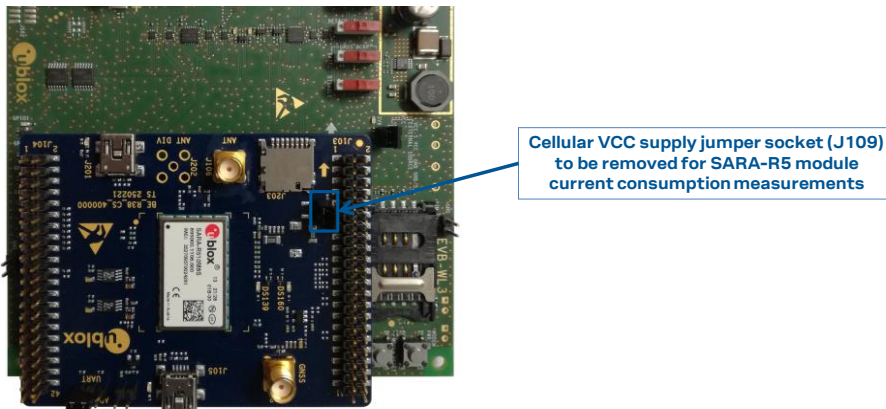

**Figure 6: Jumper socket to be removed for SARA-R5 series modules current consumption measurement**

A suitable external digital multi-meter (as for example the Keysight/Agilent 34465A, 34410A or 34411A) can be used for current consumption measurements. In this case, the 3.8 V supply circuit on the EVB will supply the cellular module mounted on the adapter board, with the digital multi-meter placed in series as illustrated in [Figure 7](#).

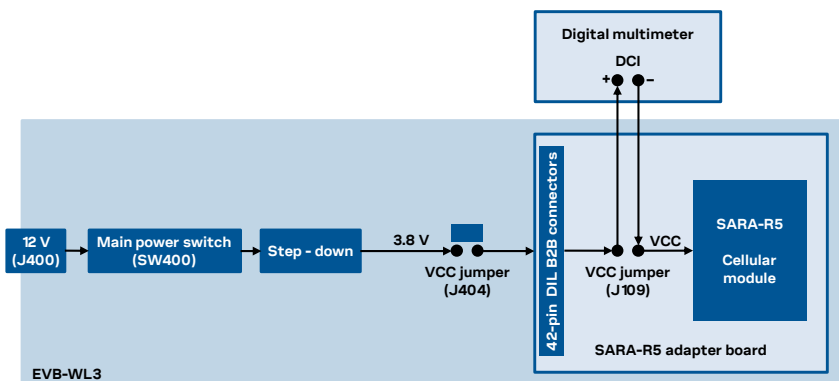

**Figure 7: Block diagram of current consumption setup for SARA-R5 series modules**

Alternatively, a suitable external DC power supply with dynamic current measurement capabilities (as for example, the portable and cheap Qoitech Otii Arc, or the more accurate Keysight N6705B, or the models designed for mobile communications Keysight 66319B/D or 66321B/D) can be used for current consumption measurements, acting also as supply source for the cellular module mounted on the adapter board, as illustrated in [Figure 8](#).

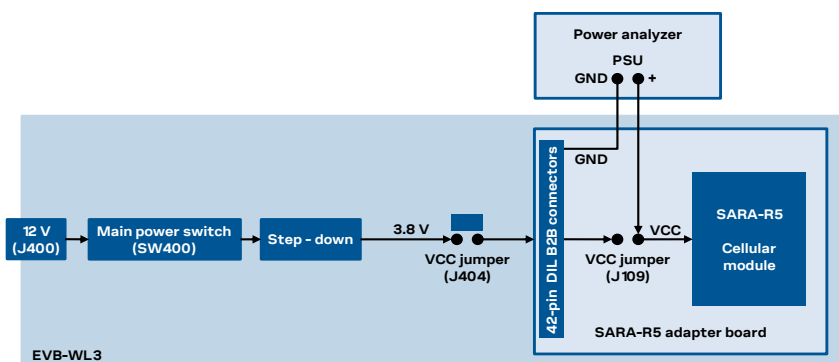

**Figure 8: Block diagram of current consumption setup for SARA-R5 series modules using a DC power analyzer**

## **E Declaration of conformities**

The equipment is intended for indoor usage. It is the user's duty to verify if further restrictions apply, such as in airplanes, hospitals, or hazardous locations (petrol stations, refineries...). Any changes or modification made to this equipment will void its compliance to the safety requirements.

Maintenance, inspections and/or repairs of the EVK-R5 shall be performed by u-blox AG.

## F Glossary

| Abbreviation | Definition   |
|--------------|--|
| ADP          | Adapter Board  |
| AT           | AT Command Interpreter Software Subsystem, or attention      |
| AWS          | Amazon Web Services  |
| B2B          | Board-To-Board   |
| CTS          | Clear To Send  |
| DCD          | Data Carrier Detect  |
| DCE          | Data Communication Equipment                                 |
| DCI          | Direct Current   |
| DIL          | Dual In Line   |
| DSR          | Data Set Ready   |
| DTE          | Data Terminal Equipment                                      |
| DTR          | Data Terminal Ready  |
| EVB          | Evaluation Board   |
| EVK          | Evaluation Kit   |
| GND          | Ground   |
| GNSS         | Global Navigation Satellite System                           |
| GPIO         | General Purpose Input Output                                 |
| HW           | Hardware   |
| I2C          | Inter-Integrated Circuit                                     |
| I2S          | Inter IC Sound   |
| IoT          | Internet of Things   |
| IP           | Internet Protocol  |
| LED          | Light Emitting Diode   |
| LTE          | Long Term Evolution  |
| NB           | Narrow Band  |
| PSD          | Packet-Switched Data   |
| PSU          | Power Supply Unit  |
| RAT          | Radio Access Technology                                      |
| RF           | Radio Frequency  |
| RI           | Ring Indicator   |
| RTS          | Request To Send  |
| Rx           | Receiver   |
| SDIO         | Secure Digital Input Output                                  |
| SIM          | Subscriber Identity Module                                   |
| SMA          | SubMiniature version A                                       |
| TCP          | Transfer Control Protocol                                    |
| Tx           | Transmitter  |
| UART         | Universal Asynchronous Receiver-Transmitter serial interface |
| UDP          | User Datagram Protocol                                       |
| USB          | Universal Serial Bus   |



## Related documentation

- [1] u-blox SARA-R5 series AT commands manual, [UBX-19047455](#)
- [2] u-blox SARA-R5 series data sheet, [UBX-19016638](#)
- [3] u-blox SARA-R510AWS data sheet, [UBX-22016999](#)
- [4] u-blox SARA-R5 series system integration manual, [UBX-19041356](#)
- [5] u-blox SARA-R5 series application development guide, [UBX-20009652](#)
- [6] u-blox SARA-R510AWS application development guide, [UBX-22017004](#)
- [7] AWS IoT ExpressLink programmer's guide, <https://docs.aws.amazon.com/iot-expresslink/>

All these documents are available on our website (<http://www.u-blox.com>).

 For regular updates to u-blox documentation and to receive product change notifications, register on our homepage ([www.u-blox.com](http://www.u-blox.com)).

## Revision history

| Revision | Date        | Name        | Comments  |
|----------|-------------|-------------|---|
| R01      | 22-Oct-2019 | fvid        | Initial release.  |
| R02      | 11-Nov-2019 | lpah        | Updated document products applicability.  |
| R03      | 23-Dec-2019 | mmar / fvid | Added AT commands examples. Added USIO variants 3 and 4.  |
| R04      | 11-Mar-2020 | fvid        | Extended document applicability to EVK-R500S.<br>Updated product status to prototype.   |
| R05      | 15-Jul-2020 | fvid        | Updated pictures, B2B connectors and pin out.   |
| R06      | 02-Oct-2020 | sses        | Updated product status to initial production.<br>Added AT commands examples. Other minor corrections and clarifications.  |
| R07      | 22-Dec-2020 | lpah        | Updated modem and application version.  |
| R08      | 11-May-2021 | fvid        | Extended applicability to EVK-R500S-1-00, EVK-R510S-1-00,<br>EVK-R510M8S-1-00. Updated pictures.  |
| R09      | 06-Aug-2021 | fvid        | Updated LEDs, connectors and pin out. Updated pictures.   |
| R10      | 07-Apr-2022 | sses        | Extended applicability to EVK-R500S-6, EVK-R500S-7, EVK-R510S-6,<br>EVK-R510S-7, EVK-R510M8S-6, EVK-R510M8S-7.<br>Updated EVK-R500S-1, EVK-R510S-1, EVK-R510M8S-1 product status. |
| R11      | 16-Dec-2022 | fvid        | Extended applicability to EVK-R510AWS-01.   |
| R12      | 12-Apr-2023 | yatu        | Updated SARA-R510AWS power off method.  |

## Contact

### u-blox AG

Address: Zürcherstrasse 68  
8800 Thalwil  
Switzerland

For further support and contact information, visit us at [www.u-blox.com/support](http://www.u-blox.com/support).