

HB-2X2-WW

~65° wide beam optimized for CREE XP-L and XM-L

TECHNICAL SPECIFICATIONS:

Dimensions	50.0 mm
Height	8.5 mm
Fastening	pin, screw
Colour	clear
Box size	480 x 280 x 300 mm
Box weight	9.2 kg
Quantity in Box	800 pcs
ROHS compliant	yes ⓘ







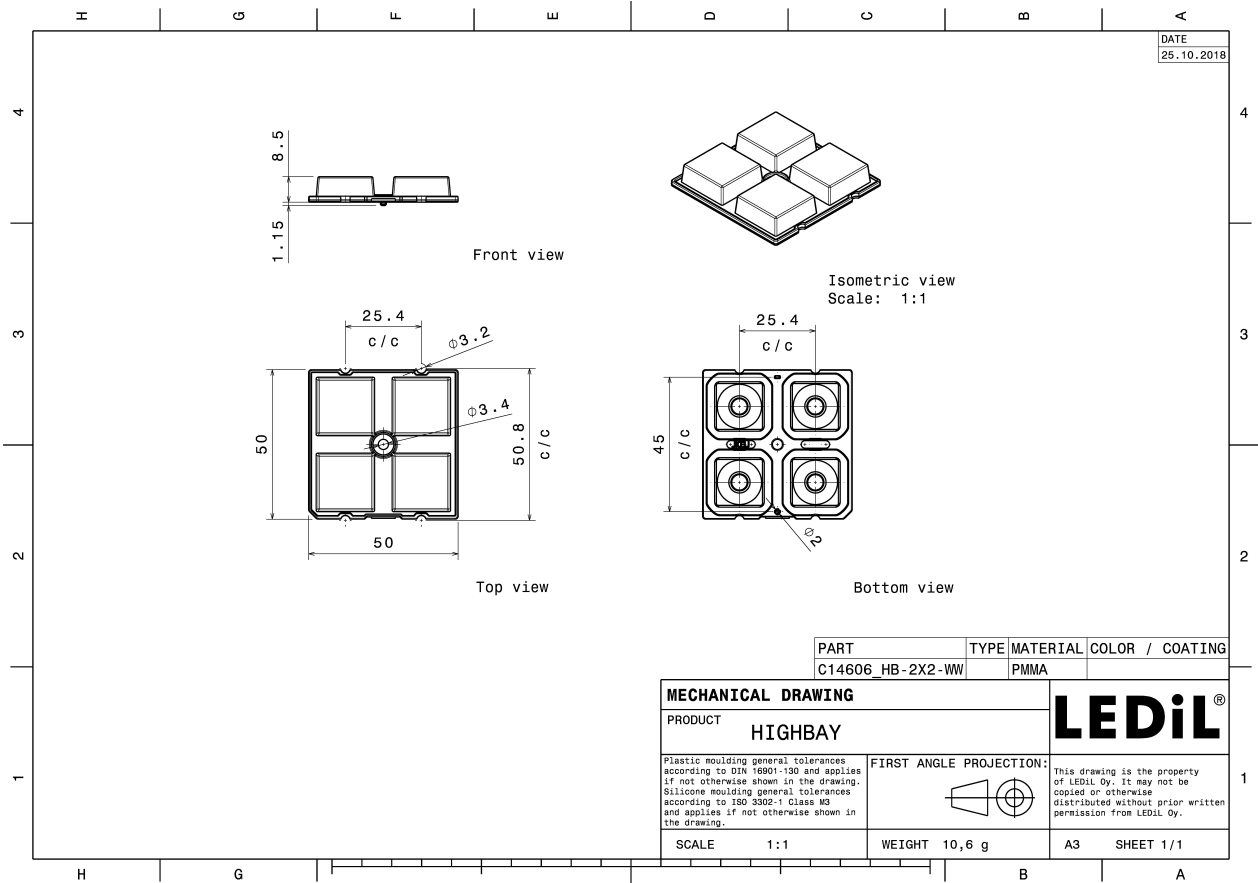

MATERIAL SPECIFICATIONS:

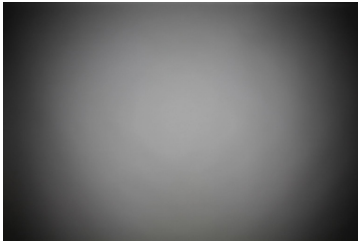
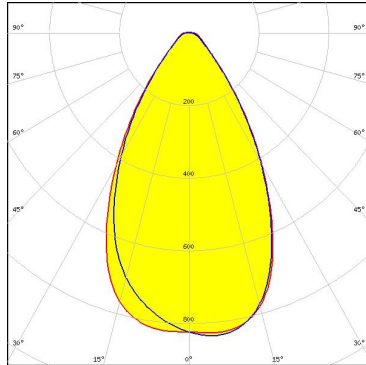
Component	Type	Material	Colour
HB-2X2-WW	Multi-lens	PMMA	clear

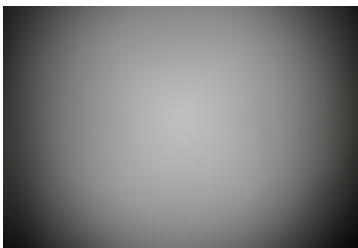
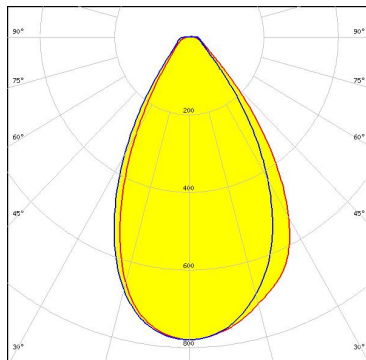

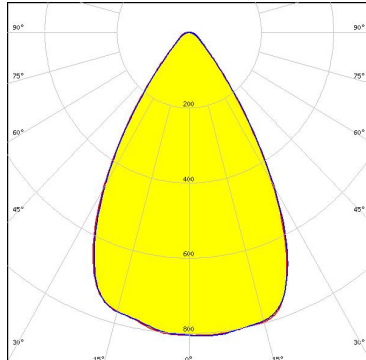
PHOTOMETRIC DATA (MEASURED):

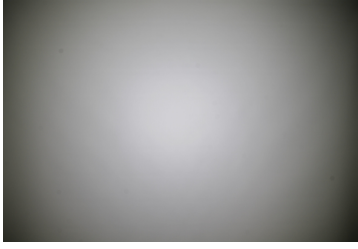
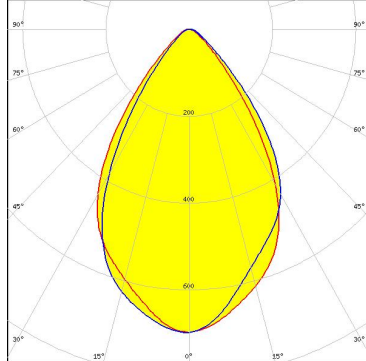
<p> bridgelux</p> <p>LED Bridgelux SMD 5050 FWHM 59.0° Efficiency 94 % Peak intensity 0.840 cd/lm LEDs/each optic 1 Light colour White Required components:</p>		
<p> CREE</p> <p>LED XD16 FWHM 61.0° Efficiency 92 % Peak intensity 0.780 cd/lm LEDs/each optic 4 Light colour White Required components:</p>		
<p> CREE</p> <p>LED XD16 FWHM 63.0° Efficiency 93 % Peak intensity 0.800 cd/lm LEDs/each optic 1 Light colour White Required components:</p>		
<p> CREE</p> <p>LED XHP35 HD FWHM 67.0° Efficiency 84 % Peak intensity 0.700 cd/lm LEDs/each optic 1 Light colour White Required components:</p>		

PHOTOMETRIC DATA (MEASURED):

CREE

LED XM-L
 FWHM 66.0°
 Efficiency 93 %
 Peak intensity 0.760 cd/lm
 LEDs/each optic 1
 Light colour White
 Required components:

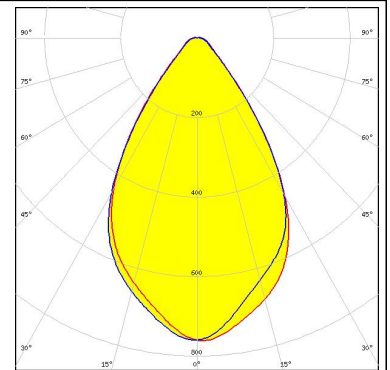
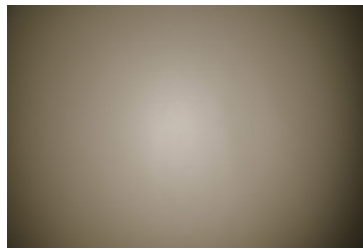

CREE

LED XM-L2
 FWHM 62.0°
 Efficiency 92 %
 Peak intensity 0.803 cd/lm
 LEDs/each optic 1
 Light colour White
 Required components:

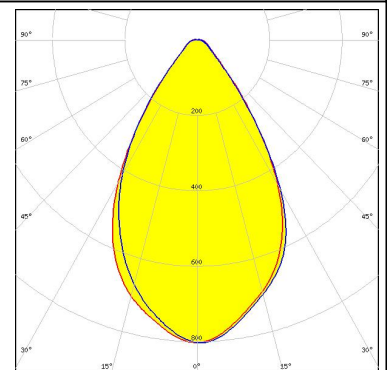
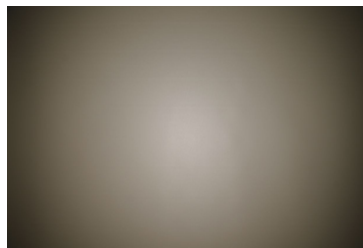

CREE

LED XP-G2
 FWHM 63.0°
 Efficiency 91 %
 Peak intensity 0.830 cd/lm
 LEDs/each optic 1
 Light colour White
 Required components:

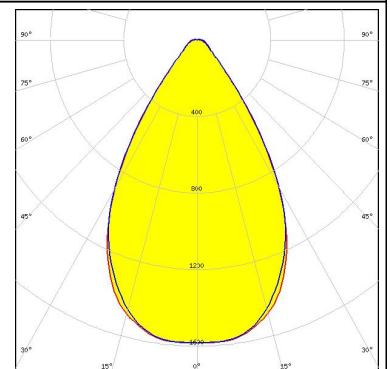

CREE

LED XP-G3
 FWHM 64.0°
 Efficiency 86 %
 Peak intensity 0.780 cd/lm
 LEDs/each optic 1
 Light colour White
 Required components:

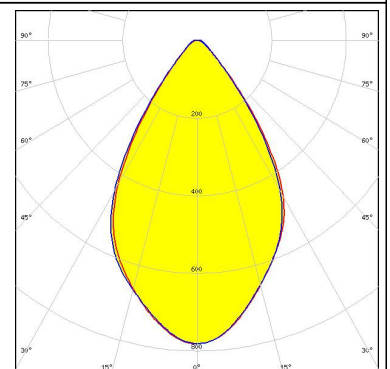
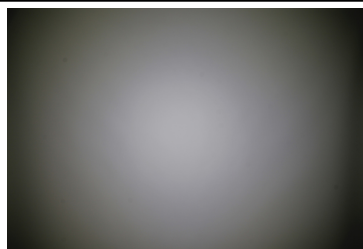

PHOTOMETRIC DATA (MEASURED):



LED XP-L HD
 FWHM 66.0°
 Efficiency 93 %
 Peak intensity 0.735 cd/lm
 LEDs/each optic 1
 Light colour White
 Required components:

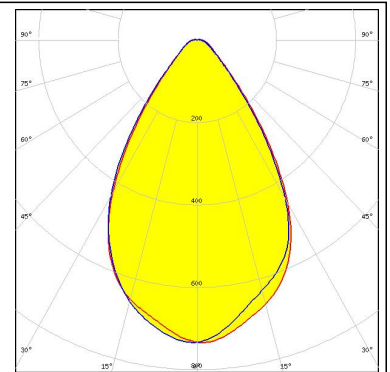
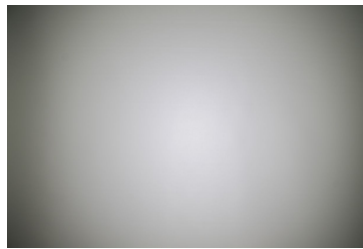

LED XP-L2
 FWHM 62.0°
 Efficiency 93 %
 Peak intensity 0.770 cd/lm
 LEDs/each optic 1
 Light colour White
 Required components:

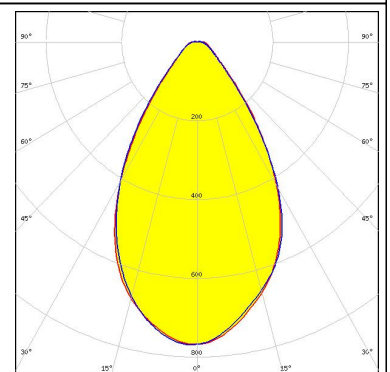

LED H35C1 (LEMWA33)
 FWHM 63.0°
 Efficiency 92 %
 Peak intensity 0.820 cd/lm
 LEDs/each optic 1
 Light colour White
 Required components:

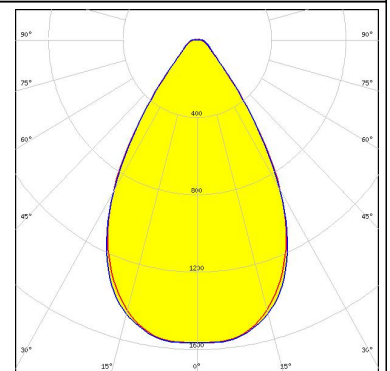
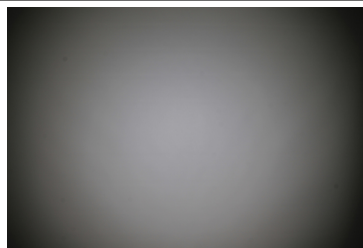

LED LUXEON 5050 Round LES
 FWHM 61.0°
 Efficiency 94 %
 Peak intensity 0.820 cd/lm
 LEDs/each optic 1
 Light colour White
 Required components:

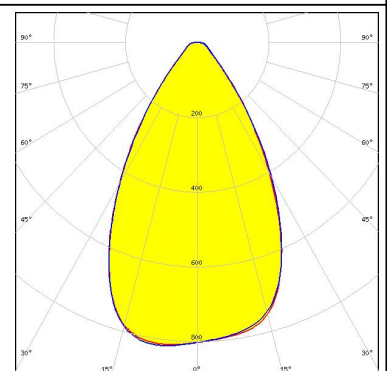
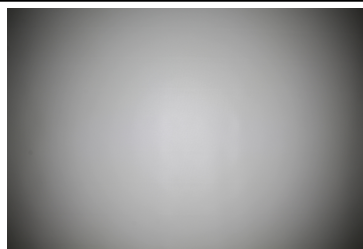

PHOTOMETRIC DATA (MEASURED):

LUMILEDS

LED LUXEON V
 FWHM 63.0°
 Efficiency 93 %
 Peak intensity 0.800 cd/m
 LEDs/each optic 1
 Light colour White
 Required components:

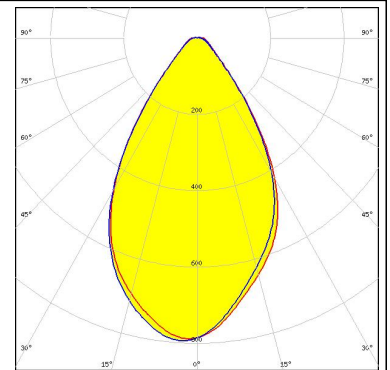
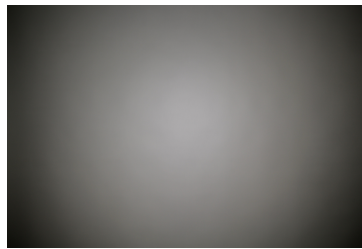

LUMILEDS

LED LUXEON V2
 FWHM 61.0°
 Efficiency 94 %
 Peak intensity 0.880 cd/m
 LEDs/each optic 1
 Light colour White
 Required components:

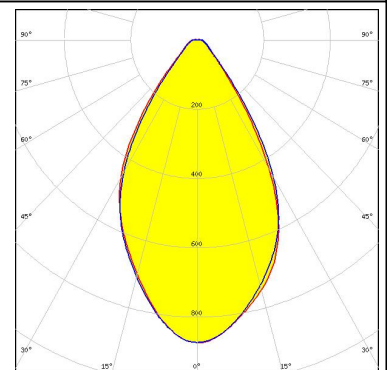
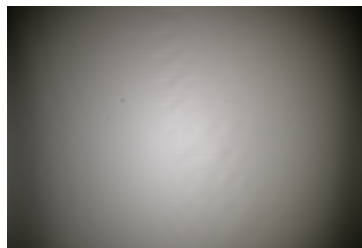

NICHIA

LED NVSW219D
 FWHM 64.0°
 Efficiency 94 %
 Peak intensity 0.810 cd/m
 LEDs/each optic 1
 Light colour White
 Required components:

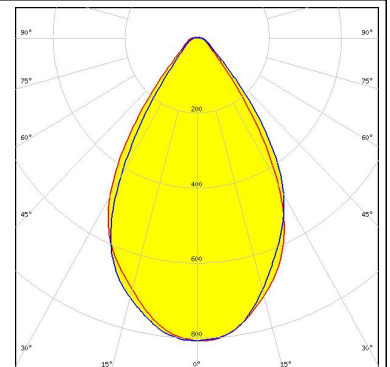

NICHIA

LED NVSW219F
 FWHM 66.0°
 Efficiency 94 %
 Peak intensity 0.800 cd/m
 LEDs/each optic 1
 Light colour White
 Required components:

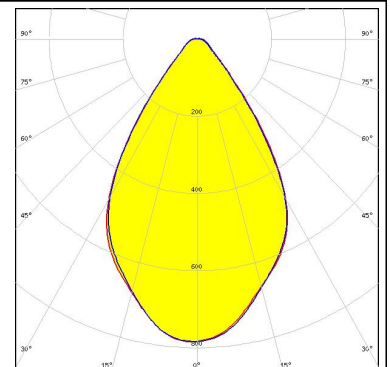
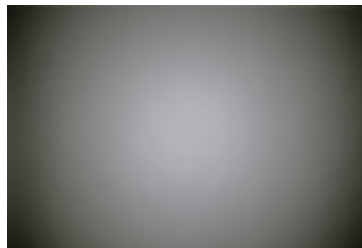

PHOTOMETRIC DATA (MEASURED):



LED NVSW319B
 FWHM 68.0°
 Efficiency 93 %
 Peak intensity 0.750 cd/lm
 LEDs/each optic 1
 Light colour White
 Required components:

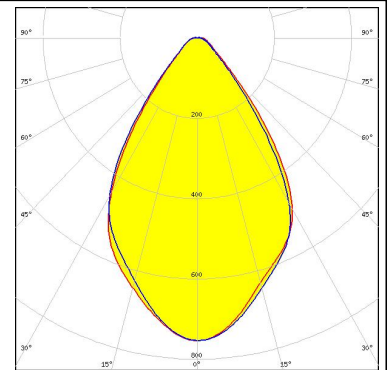

LED NVSW3x9A
 FWHM 62.0°
 Efficiency 93 %
 Peak intensity 0.830 cd/lm
 LEDs/each optic 1
 Light colour White
 Required components:

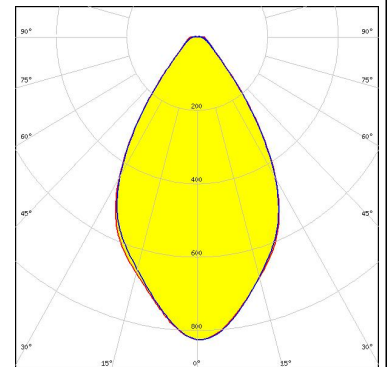

LED NWSx229A
 FWHM 63.0°
 Efficiency 85 %
 Peak intensity 0.770 cd/lm
 LEDs/each optic 1
 Light colour White
 Required components:

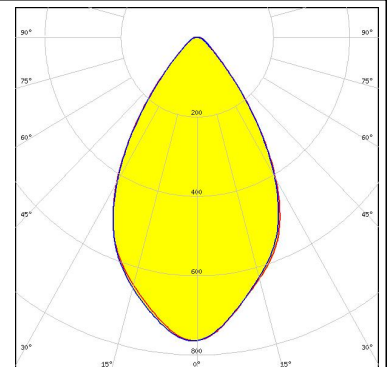
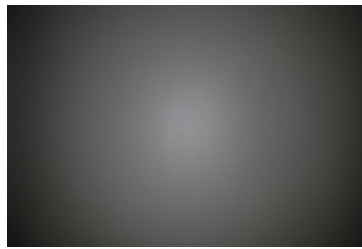

LED PrevaLED Brick HP 2x8
 FWHM 64.0°
 Efficiency 92 %
 Peak intensity 0.820 cd/lm
 LEDs/each optic 1
 Light colour White
 Required components:

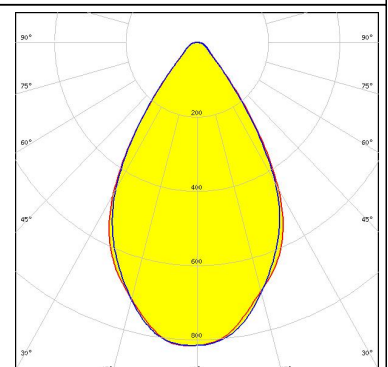
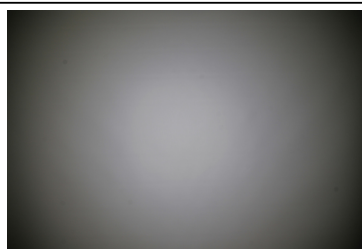

PHOTOMETRIC DATA (MEASURED):

OSRAM

Opto Semiconductors

LED Duris S8
 FWHM 61.0°
 Efficiency 93 %
 Peak intensity 0.800 cd/lm
 LEDs/each optic 1
 Light colour White
 Required components:

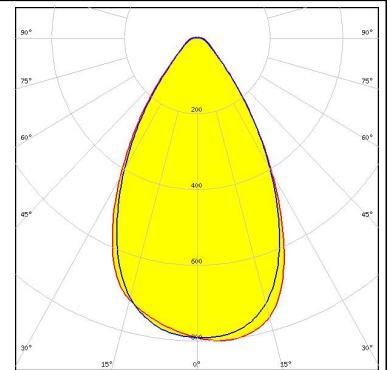

OSRAM

Opto Semiconductors

LED OSOLON Square CSSRM2/CSSRM3
 FWHM 64.0°
 Efficiency 92 %
 Peak intensity 0.820 cd/lm
 LEDs/each optic 1
 Light colour White
 Required components:

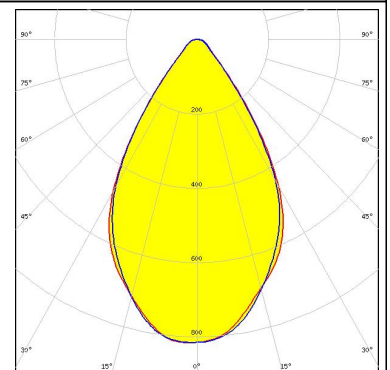
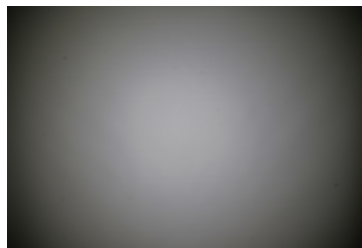

PHILIPS

LED Fortimo FastFlex LED 2x8 DA G4
 FWHM 64.0°
 Efficiency 93 %
 Peak intensity 0.790 cd/lm
 LEDs/each optic 1
 Light colour White
 Required components:

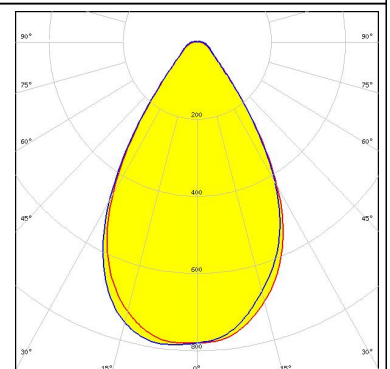
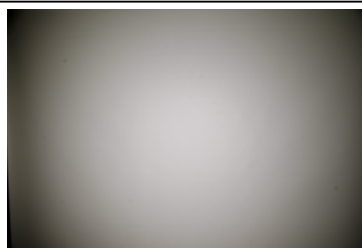

SAMSUNG

LED HiLOM RH16 (LH351C)
 FWHM 61.0°
 Efficiency 94 %
 Peak intensity 0.850 cd/lm
 LEDs/each optic 1
 Light colour White
 Required components:

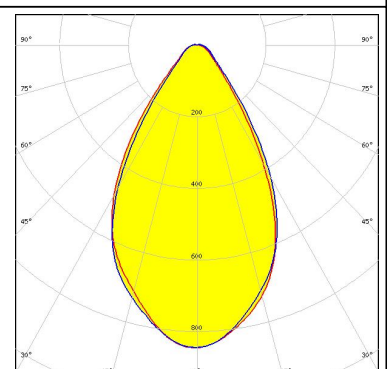
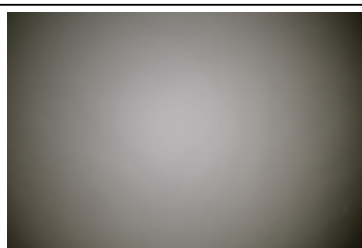

PHOTOMETRIC DATA (MEASURED):

SAMSUNG

LED LH351B
 FWHM 62.0°
 Efficiency 86 %
 Peak intensity 0.830 cd/lm
 LEDs/each optic 1
 Light colour White
 Required components:

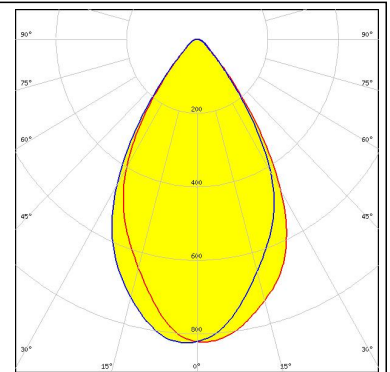
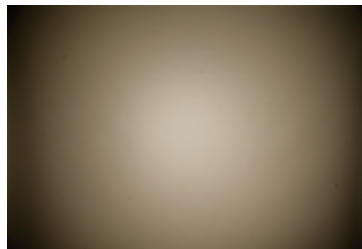

SAMSUNG

LED LH351C
 FWHM 62.0°
 Efficiency 93 %
 Peak intensity 0.840 cd/lm
 LEDs/each optic 1
 Light colour White
 Required components:

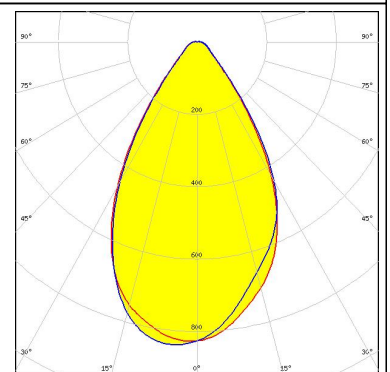
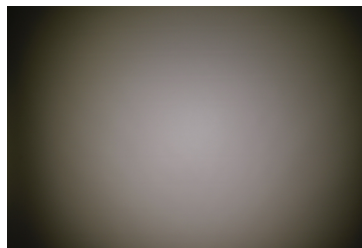

SAMSUNG

LED LH351D
 FWHM 62.0°
 Efficiency 91 %
 Peak intensity 0.780 cd/lm
 LEDs/each optic 1
 Light colour White
 Required components:

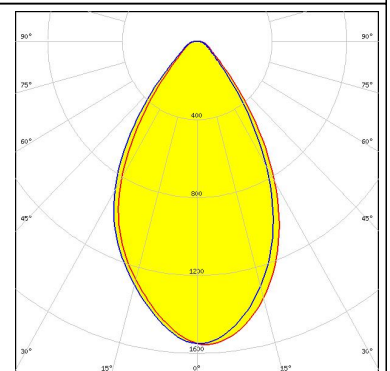
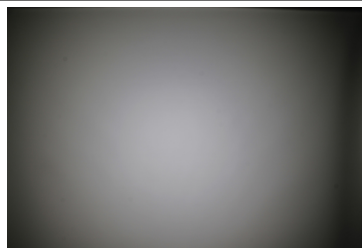





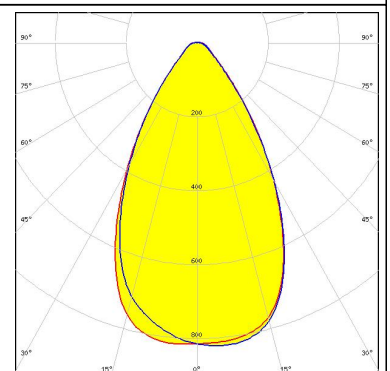
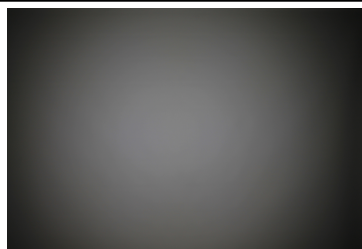



SAMSUNG

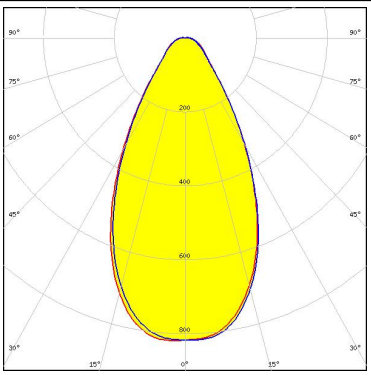

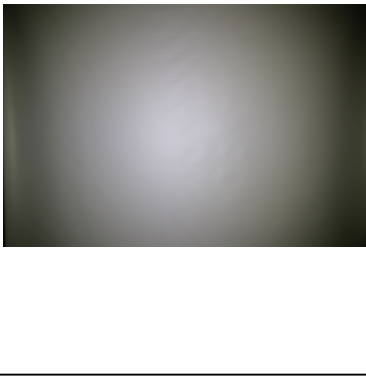
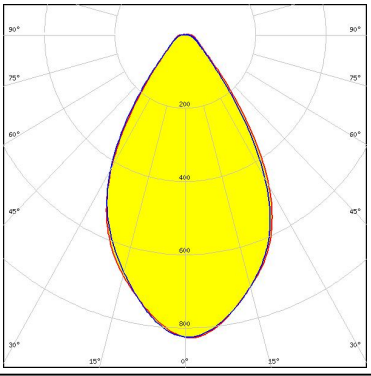

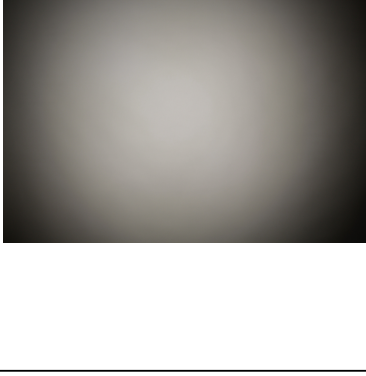
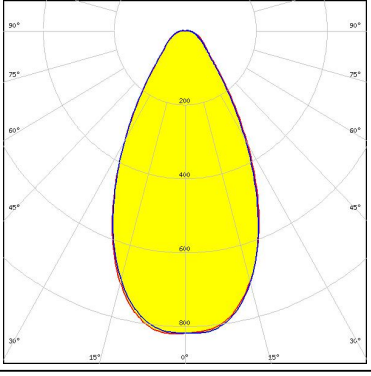

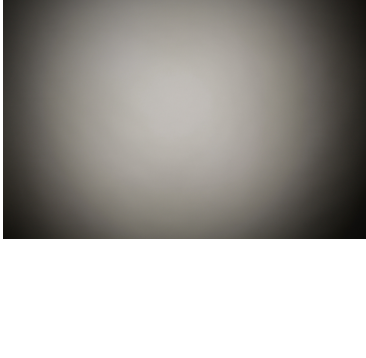
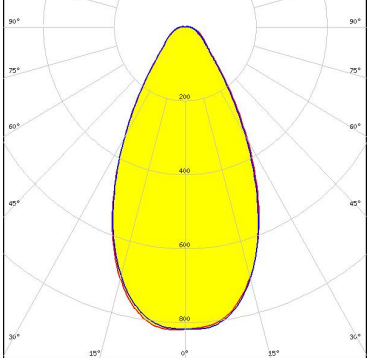

LED LH508A
 FWHM 60.0°
 Efficiency 93 %
 Peak intensity 0.820 cd/lm
 LEDs/each optic 1
 Light colour White
 Required components:

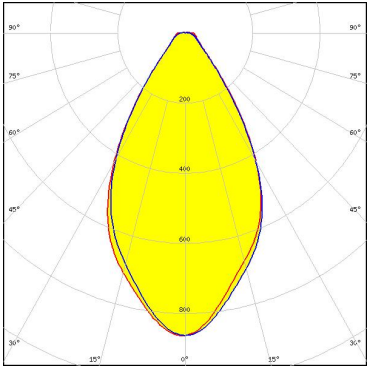

PHOTOMETRIC DATA (MEASURED):

<p> SEOUL SEMICONDUCTOR</p> <p>LED 2x2 Y22 module - SMJQ-D48W16AA-XX FWHM 55.0° Efficiency 92 % Peak intensity 0.820 cd/m LEDs/each optic 1 Light colour White Required components:</p>		
<p> SEOUL SEMICONDUCTOR</p> <p>LED Z5M3 FWHM 62.0° Efficiency 94 % Peak intensity 0.830 cd/m LEDs/each optic 1 Light colour White Required components:</p>		
<p> SEOUL SEMICONDUCTOR</p> <p>LED Z8Y19 FWHM 55.0° Efficiency 92 % Peak intensity 0.820 cd/m LEDs/each optic 4 Light colour White Required components:</p>		
<p> SEOUL SEMICONDUCTOR</p> <p>LED Z8Y19 FWHM 55.0° Efficiency 92 % Peak intensity 0.820 cd/m LEDs/each optic 4 Light colour White Required components:</p>		

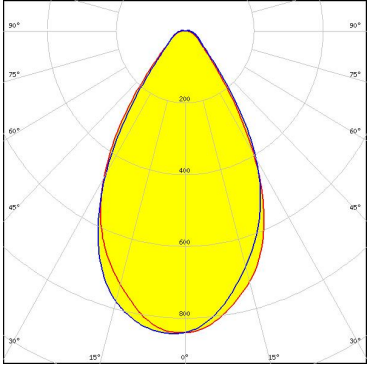
PHOTOMETRIC DATA (MEASURED):

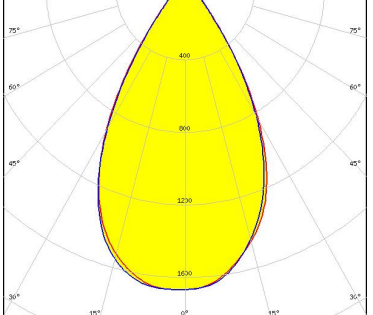
<p> SEOUL SEMICONDUCTOR</p> <p>LED Z8Y22P FWHM 59.0° Efficiency 92 % Peak intensity 0.860 cd/lm LEDs/each optic 1 Light colour White Required components:</p>		
<h3>TRIDONIC</h3>		
<p>LED RLE 2x4 2000lm HP EXC2 OTD FWHM 61.0° Efficiency 94 % Peak intensity 0.850 cd/lm LEDs/each optic 1 Light colour White Required components:</p>		
<h3>TRIDONIC</h3>		
<p>LED RLE 2x8 4000lm HP EXC2 OTD FWHM 61.0° Efficiency 94 % Peak intensity 0.850 cd/lm LEDs/each optic 1 Light colour White Required components:</p>		
<h3>TRIDONIC</h3>		
<p>LED RLE G1 49x121mm 2000lm xxx EXC OTD FWHM 61.0° Efficiency 94 % Peak intensity 0.830 cd/lm LEDs/each optic 1 Light colour White Required components:</p>		

PHOTOMETRIC DATA (MEASURED):

TRIDONIC

LED RLE G1 49x133mm 2000lm xxx EXC OTD
FWHM 61.0°
Efficiency 94 %
Peak intensity 0.830 cd/lm
LEDs/each optic 1
Light colour White
Required components:

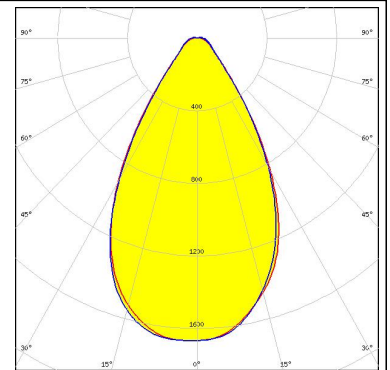

TRIDONIC

LED RLE G1 49x223mm 4000lm xxx EXC OTD
FWHM 61.0°
Efficiency 94 %
Peak intensity 0.830 cd/lm
LEDs/each optic 1
Light colour White
Required components:

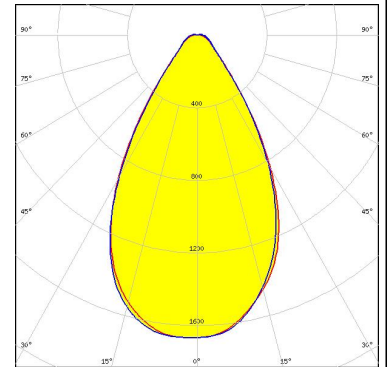
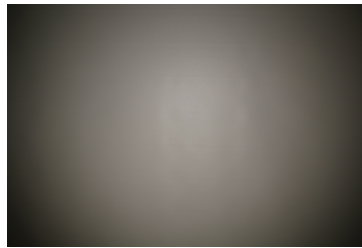

TRIDONIC

LED RLE G1 49x245mm 4000lm xxx EXC OTD
FWHM 61.0°
Efficiency 94 %
Peak intensity 0.830 cd/lm
LEDs/each optic 1
Light colour White
Required components:

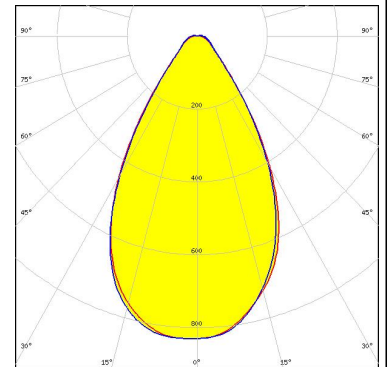
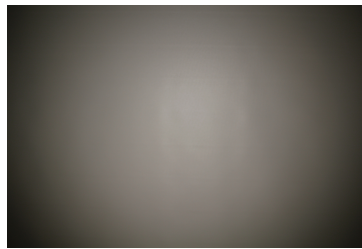

PHOTOMETRIC DATA (SIMULATED):



LED XP-G2 HE
 FWHM 73.0°
 Efficiency 95 %
 Peak intensity 0.723 cd/lm
 LEDs/each optic 1
 Light colour White
 Required components:

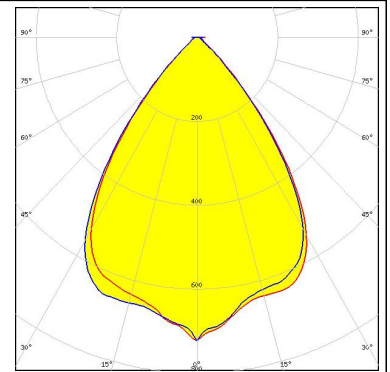

LED XT-E
 FWHM 69.0°
 Efficiency 94 %
 Peak intensity 0.780 cd/lm
 LEDs/each optic 1
 Light colour White
 Required components:

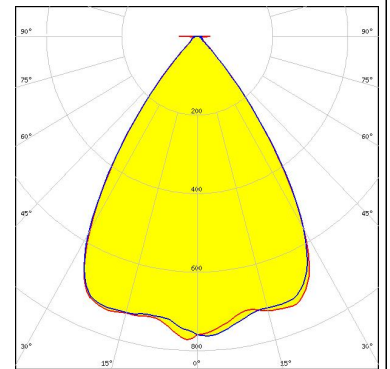

LED LUXEON 3535L
 FWHM 66.0°
 Efficiency 94 %
 Peak intensity 0.870 cd/lm
 LEDs/each optic 1
 Light colour White
 Required components:

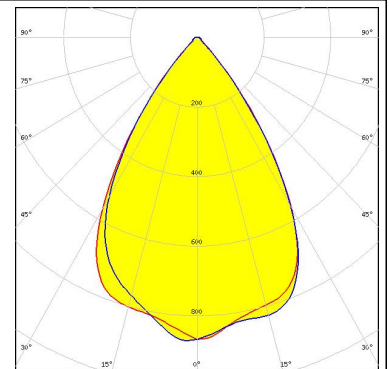

LED LUXEON MZ
 FWHM 66.0°
 Efficiency 94 %
 Peak intensity 0.880 cd/lm
 LEDs/each optic 1
 Light colour White
 Required components:

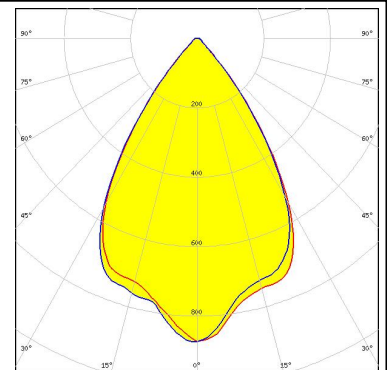
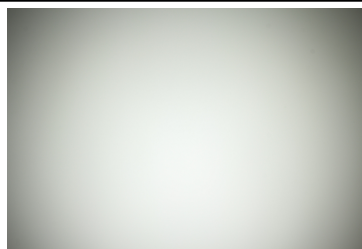

PHOTOMETRIC DATA (SIMULATED):

<p>OSRAM Opto Semiconductors</p> <p>LED OSCONIQ P 3030</p> <p>FWHM 66.0°</p> <p>Efficiency 96 %</p> <p>Peak intensity 0.831 cd/lm</p> <p>LEDs/each optic 1</p> <p>Light colour White</p> <p>Required components:</p>	
<p>OSRAM Opto Semiconductors</p> <p>LED OSCONIQ P 3737 (2W version)</p> <p>FWHM 66.0°</p> <p>Efficiency 96 %</p> <p>Peak intensity 0.872 cd/lm</p> <p>LEDs/each optic 1</p> <p>Light colour White</p> <p>Required components:</p>	
<p>OSRAM Opto Semiconductors</p> <p>LED OSCONIQ P 3737 (3W version)</p> <p>FWHM 66.0°</p> <p>Efficiency 94 %</p> <p>Peak intensity 0.920 cd/lm</p> <p>LEDs/each optic 1</p> <p>Light colour White</p> <p>Required components:</p>	
<p>OSRAM Opto Semiconductors</p> <p>LED OSCONIQ P 3737 Flat</p> <p>FWHM 64.0°</p> <p>Efficiency 95 %</p> <p>Peak intensity 0.915 cd/lm</p> <p>LEDs/each optic 1</p> <p>Light colour White</p> <p>Required components:</p>	

PHOTOMETRIC DATA (SIMULATED):

OSRAM

Opto Semiconductors

LED OSOLON SSL 80
FWHM 55.6°
Efficiency 94 %
Peak intensity 1.100 cd/lm
LEDs/each optic 1
Light colour White
Required components:

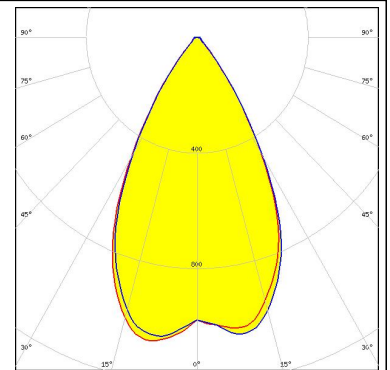

PHILIPS

LED Fortimo FastFlex LED 2x8 DAX G4
FWHM 71.0°
Efficiency 94 %
Peak intensity 0.760 cd/lm
LEDs/each optic 1
Light colour White
Required components:

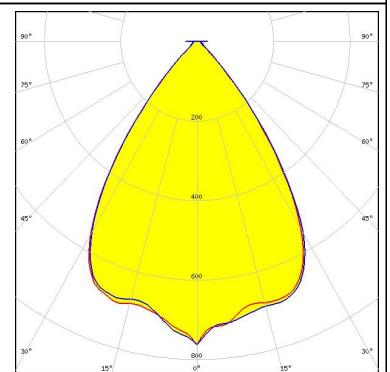

SAMSUNG

LED LH231B
FWHM 60.0°
Efficiency 94 %
Peak intensity 1.000 cd/lm
LEDs/each optic 4
Light colour White
Required components:

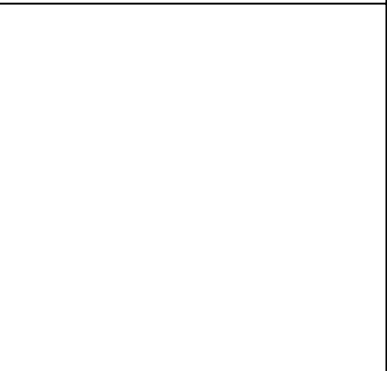

SEOUL SEMICONDUCTOR

LED SEOUL DC 5050 6V
FWHM 64.0°
Efficiency 94 %
Peak intensity 0.790 cd/lm
LEDs/each optic 1
Light colour White
Required components:

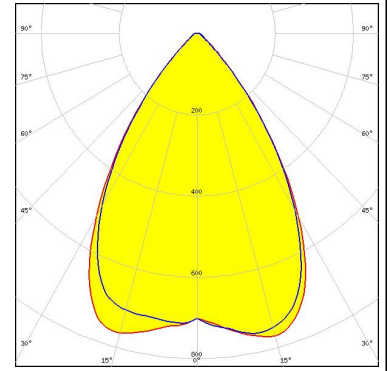

PHOTOMETRIC DATA (SIMULATED):

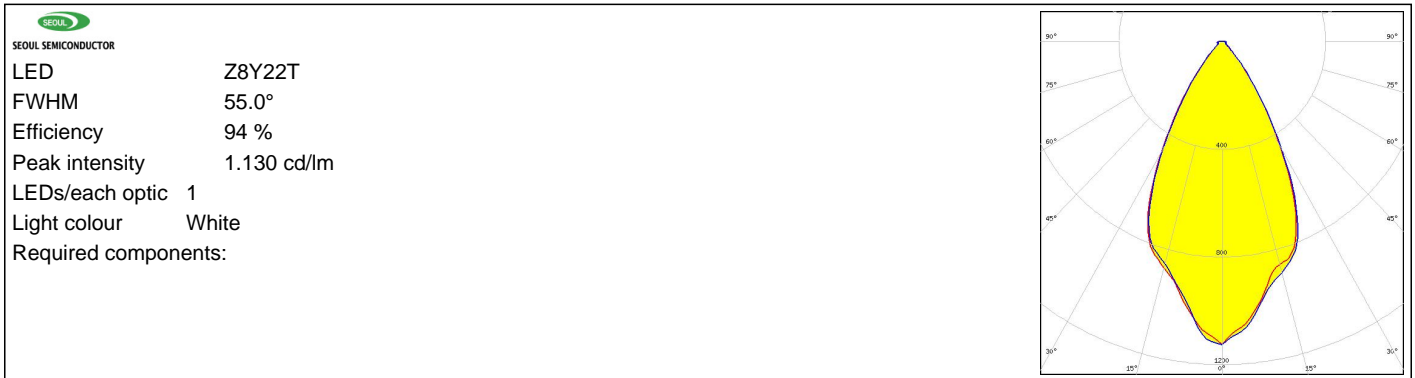

GENERAL INFORMATION:

NOTE: The typical beam angle will be changed by different color, chip size and chip position tolerance. The typical total beam angle is the full angle measured where the luminous intensity is half of the peak value.

MATERIALS:

As part of our continuous research and improvement processes, and to ensure the best possible quality and availability of our products, LEDiL reserves the right to change material grades without notice.

PRODUCT DATA USER AGREEMENT AND DISCLAIMER:

The measured data in the provided downloadable LEDiL Product Datasheets and Mechanical 2D-Drawings is rounded and provided as reference for planning. LEDiL Oy's optical specifications have been verified by conducting performance testing of the products in accordance with the company's quality system. The reported data are averaged results of multiple measurements with typical variation. LEDiL Oy reserves the right to without prior notification make changes and improvements to its products.

LEDiL Oy assumes neither warranty, nor guarantee nor any other liability of any kind for the contents and correctness of the provided data. The provided data has been generated with highest diligence but the provided data may in reality not represent the complete possible variation range of all intrinsic parameters. Therefore, in certain cases a deviation from the provided data could occur.

LEDiL Oy reserves the right to undertake technical changes of its products without further notification which could lead to changes in the provided data. LEDiL Oy assumes no liability of any kind for the possible deviation from any provided data or any other damage resulting from the usage of the provided data.

The user agrees to this disclaimer and user agreement with the download or usage of the provided files.

LEDiL Oy

Joensuunkatu 13
FI-24240 SALO
Finland

LEDiL Inc.

228 West Page Street
Suite D
Sycamore IL 60178
USA

Local sales and technical support

[www.ledil.com/
where_to_buy](http://www.ledil.com/where_to_buy)

Shipping locations

Salo, Finland
Hong Kong, China

Distribution Partners

[www.ledil.com/
where_to_buy](http://www.ledil.com/where_to_buy)