

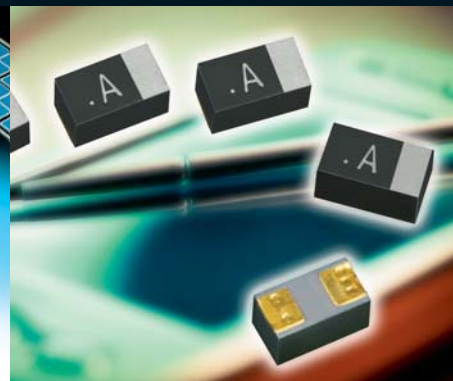

POLYMER, TANTALUM AND NIOBIUM OXIDE CAPACITORS

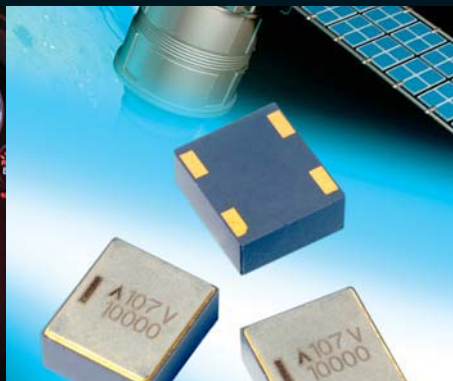

Version 17.3



Technological Leadership in Tantalum and Niobium

www.avx.com

Introduction to AVX Solid Electrolytics Portfolio.....	2-3
--	-----

SECTION 1: SOLID TANTALUM & NIOBIUM OXIDE CHIP CAPACITORS

Tantalum and Niobium Oxide Products Introduction and Road Map	4-5
---	-----

Resin Molded Solid Tantalum Chip, J-Lead

TAJ Series – Standard & Low Profile	6-17
TAJ Series – Automotive Product Range	18-24
F92 Series – Low Profile.....	25-28
F93 Series	29-32
F93-AJ6 Series – Automotive Product Range	33-36

High CV Resin Molded Solid Tantalum Chip

TLJ Series – J-Lead	37-41
TLN Series – Undertab	42-44
TLN PulseCap™ Series – High Capacitance - Undertab	45-46
F98 Series – Undertab.....	47-50
F98-AS1 Series – Fused Tantalum Chip - Undertab.....	51-52

Low ESR Resin Molded Solid Tantalum Chip, J-Lead

TPS Series – Standard & Low Profile.....	53-65
TPS Series – Automotive Product Range	66-72
F91 Series	73-75
F91-AJ6 Series – Automotive Product Range	76-77
TPM Series – Multianode, Ultra Low ESR	78-81

High Performance Resin Molded Solid Tantalum Chip

TRJ Series – Enhanced Reliability Professional & Automotive Grade - J-Lead.....	82-89
F97 Series – Enhanced Reliability Professional & Automotive Grade - J-Lead.....	90-93
TRM Series – Enhanced Reliability Professional Grade Multianode - J-Lead	94-97
TMJ Sigma™ Series – LAT* Professional Grade - J-Lead.....	98-102
THJ Series – High Temperature (175°C max.) - J-Lead.....	103-107
THJ Extended Series – High Temperature (200°C max.) - J-Lead	108-110
THH Hermetic Series – High Temperature (230°C max.) Hermetic SMD Chip	111-114

TACmicrochip®

TAC Series – Standard and Low Profile TACmicrochip®	115-121
TLC Series – High CV TACmicrochip®	122-125
TPC Series – Low ESR TACmicrochip®	126-130

Conformal Coated Tantalum Chip

F95 Series – Standard	131-134
F95 Audio Series – Optimized for Audio Applications.....	135-137
F72/F75 Series – Low Profile and HiCV	138-140

Resin Molded OxiCap® Solid Niobium Oxide Chip, J-Lead

NOJ Series – Standard and Low Profile OxiCap®	141-147
NLJ Series – High CV OxiCap®	148-150
NOS Series – Low ESR OxiCap®	151-156
NOM Series – Multianode Ultra-Low ESR OxiCap®	157-159

SECTION 2: SOLID CONDUCTIVE POLYMER ELECTROLYTIC CHIP CAPACITORS

TCJ Series – Standard and Low Profile - J-Lead	160-168
TCM Series – Multianode Ultra Low ESR - J-Lead	169-171
TCN Series – High CV/cc - Undertab	172-175
J-CAP™ Series – Highest Joules/cc - Undertab.....	176-179
F38 Series – Miniature - Undertab	180-182
TCQ Series – Automotive - J-Lead	183-185
TCR Series – Professional Grade - J-Leads	186-188
TCH Low ESR Hermetic Series – SMD Hermetic Chip.....	189-192

SECTION 3: LEADED TANTALUM

Introduction	193
Dipped Radial Capacitors	194
Dipped Radial	
TAP/TEP Series Wire Form Outline.....	194
TAP Series.....	195-197
TEP Series	198-200
TAP/TEP Series Tape & Reel	201-202

SECTION 4: TECHNICAL SUMMARY AND APPLICATION GUIDELINES

Introduction.....	203-204
Section 1: Electrical Characteristics and Explanation of Terms.....	205-209
Section 2: A.C. Operation, Ripple Voltage and Ripple Current.....	210-212
Section 3: Reliability and Calculation of Failure Rate	213-215
Section 4: Application Guidelines for Tantalum and OxiCap® Capacitors	216
Section 5: Terminations.....	217
Section 6: Mechanical and Thermal Properties of Capacitors	218-219
Section 7: Epoxy Flammability.....	219
Section 8: Qualification Approval Status	219
Product Safety and Environmental Information Data	220-223
Tantalum & Niobium Oxide Capacitors (excluding F-Series) – Tape & Reel Packaging.....	224-227
F-Series Capacitors – Tape & Reel Packaging.....	228

TAP/TEP TECHNICAL SUMMARY AND APPLICATION GUIDELINES

Section 1: Electrical Characteristics and Explanation of Terms.....	229-232
Section 2: A.C. Operation, Ripple Voltage and Ripple Current	233
Section 3: Reliability and Calculation of Failure Rate	234-236
Section 4: Application Guidelines for Tantalum Capacitors	237
Questions and Answers	238-241

SOFTWARE TOOLS	242
----------------------	-----

PRODUCT LISTING.....	243
----------------------	-----

RANGE OF SAMPLE KITS.....	244
---------------------------	-----

*LAT = Lot Acceptance Tested

Section 1: Introduction



AVX Tantalum

APPLICATIONS

		
Low ESR	Automotive Range	Low ESR
Low Profile Case	High Reliability	World's Smallest Tantalum
Low Failure Rate	Temperature Stability	0402 Available
High Volumetric Efficiency	ISO/TS 16949 Plant Approved	High Volumetric Efficiency
Temperature Stability	Up to 175°C (200°C)	Low Profile Versions
Stable over Time	AEC-Q200 Approval	

QUALITY STATEMENTS

AVX's focus is CUSTOMER satisfaction - customer satisfaction in the broadest sense: product quality, technical support, product availability - all at a competitive price.

In pursuance of the established goals of AVX corporation, it is the stated objective of AVX Tantalum to supply our customers with a world class service in the manufacture and supply of electronic components, while maintaining a positive return on investment.

This world class service shall be defined as consistently supplying product and services of the highest quality and reliability encompassing all aspects of the customer supply chain.

In addition, any new or changed products, processes or services will be qualified to established standards of quality and reliability.

The objectives and guidelines listed above shall be achieved by the following codes of practice:

1. *Continual objective evaluation of customer needs and expectations for the future and the leverage of all AVX resources to meet this challenge.*

2. *Continually fostering and promoting a culture of continuous improvement through ongoing training and empowered participation of employees at all levels of the company.*

3. *Continuous Process Improvement using sound engineering principles to enhance existing equipment, material and processes. This includes the application of the science of S.P.C. focused on improving the Process Capability Index, Cpk.*

The Tantalum division has plants approved to ISO 9001:2008 and ISO/TS 16949:2009 (Automotive Quality System Requirements) with the intention that all facilities world-wide will adopt this as the quality standard.

Dedicated series of tantalum and niobium oxide capacitors meets requirements of AEC-Q200.

The Tantalum division has plants approved to ISO 14001:2004 with the intention that all facilities world-wide will adopt this as the quality standard.



Introduction



AVX Tantalum

Tantalum division has manufacturing locations in Lanskrout in the Czech Republic, San Salvador, in El Salvador and Adogawa in Japan.

This division manufactures tantalum and niobium oxide capacitors. Tantalum is an element extracted from ores found alongside tin and niobium deposits; the major sources of supply are Brazil, Africa and Australasia.

Since December 1st, 2011, AVX has exclusively sourced the tantalum powder and wire used to manufacture its tantalum capacitors from smelters whose compliance with the Electronic Industry Code of Conduct (EICC) and the Global

e-Sustainability Initiative (GeSI) Conflict-Free Smelter program has been verified.

Niobium oxide is a ceramic material that can be processed to the same powder form as traditional tantalum capacitors and manufactured in an identical process.

AVX is No.1 Tantalum capacitor manufacturer with widest range of capacitors from smallest to large case sizes, from consumer to automotive, medical and aerospace level applications. AVX has a leading market position in all world regions. Call us first - **AVX your global partner.**

TECHNOLOGY TRENDS

The amount of capacitance possible with a tantalum capacitor is directly related to the type of tantalum powder used to manufacture the anode.

The following graph shows how the (capacitance) x (voltage) per gram (CV/g) has steadily increased over time, thus allowing the production of larger and larger capacitances with the same physical volume. CV/g is the measure used to define the volumetric efficiency of a powder, a higher CV/g means a higher capacitance from the same volume.

These powder improvements have been achieved through close development with the material suppliers.

AVX Tantalum is committed to driving the available technology forward as is clearly demonstrated by extended ratings continually being developed, and technologies such as TACmicrochip®, OxiCap® and unique conductive polymer technology.

If you have any specific requirements, please contact your local AVX sales office for details on how AVX Tantalum can assist you in addressing your future requirements.

WORKING WITH THE CUSTOMER - ONE STOP SHOPPING

In line with our desire to be the number one supplier in the world for passive and interconnection components, AVX is applying continuous improvement policy and development of new innovative technologies.

It is not good enough to market the best products; the customer must have access to a service system which suits his needs and benefits business.

The AVX 'one stop shopping' concept is already beneficial in meeting the needs of major OEMs while worldwide partnerships with only the premier division of distributors aids the smaller user.

Helping to market and support our customers across the breadth and depth of our electronic component line card are

a dedicated team of sales engineers, applications engineers and product marketing managers.

Total quality starts and finishes with our commitment to customer service. Where cost and quality are perceived as given quantities AVX's first in class service invariably places us in the top rank of any preferred supplier list.

Facilities are equipped with instant worldwide DP and telecommunication links connected to every sales and production site worldwide. That ensures our customers' delivery requirements are consistently met wherever in the world they may be.

Tantalum Powder CV/g

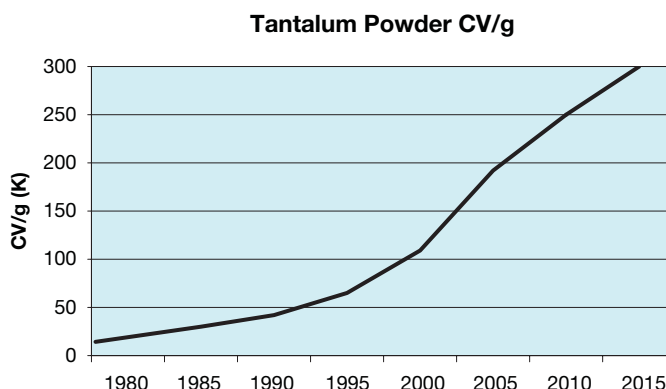

*Niobium Oxide Capacitors are manufactured and sold under patent license from Cabot Corporation, Boyertown, Pennsylvania U.S.A.

Solid Electrolytic Capacitors Road Map

	Solid Electrolyte SMD Chip									
	Standard	Low ESR	Multianodes	Polymer	PulseCap™	High CV	CWR 09, 19, 29*		Fused	Modules
							Standard	Low ESR		
Commercial	TAJ	TPS Low ESR	TPM Ultra Low ESR	TCJ	TLN PulseCap™	TLJ			F98-AS1 Fused	
	TAJ Low Profile			TCM Multianode		TLN Undertab				
	F93					F91				
	F92 Low Profile	TCN Undertab		F72/F75 Conformal						
	F95 Conformal									
Professional	TAJ Automotive	TPS Automotive	TRM	TCQ Automotive						
	F93-AJ6	F91-AJ6		TCR Professional						
	TRJ	TRJ Low ESR	TMJ							
	F97									
High-Temp	THJ 175/200°C									
CECC	TAJ CECC* 30801-011 30801-005									
COTS+*	TBJ	TBJ Low ESR	TBM Ultra Low ESR	TCB TCS			TAZ	TAZ		TCP Ultra Low ESR
DSCC*	DSCC 95158	DSCC 95158								DSCC 09009
	DSCC 07016	DSCC 07016								
MIL-PRF*	CWR11						CWR09	CWR29		
							CWR19 High CV			
Space Level*	TAJ ESCC ESCC 3012/001	TBJ SRC9000	TBM SRC9000				TAZ SRC9000	TAZ SRC9000		TCP SRC9000
		TES ESCC 3012-004	TES ESCC 3012-004				CWR 'T' Level	CWR 'T' Level		
Medical*	T4J HRC4000						TAZ HRC5000	TAZ HRC5000		TCP HRC5000
							TAZ HRC6000	TAZ HRC6000		

*See High Reliability Tantalum Catalog

NOTE: For specific requirements please contact manufacturer

SMD Solid Electrolyte Chip Capacitors Series Guide per Construction						
Construction Type / Purpose	General	Low profile	HiCV	Low ESR	Polymer	Performance
J-lead Design	TAJ	TAJ-LP	TLJ	TPS	TCJ	TRJ
				TPM		TCM
	F93	F92		F91	TCQ	THJ
					TCR	THJ+
J-lead NbO	NOJ	NOJ-LP	NLJ	NOS NOM		TMJ
TACmicrochip®	TAC	TAC-LP	TLC	TPC		
Undertab			TLN		TCN	
			TLN PulseCap™		J-CAP™	
			F98		F38	
Conformal	F95		F72/F75			AUDIO F95

Solid Electrolytic Capacitors Road Map

	TACmicrochip®			Leaded			Hermetic Sealed*		Niobium OxiCap®		
	High CV	Standard	Low ESR	Resin Dipped	Wet*	Wet** Modules	Polymer	MnO ₂	Standard	Low ESR	Multianode
Commercial	TLC	TAC	TPC	TAP/TEP Radial					NOJ NLJ	NOS	NOM
Professional					TWD		TCH	THH	NOJ	NOS	NOM
High-Temp					TWA-Y 200°C TWC-Y 200°C			THH 230°C			
CECC				TAP CECC 30201-032	TWA						
COTS+*		TBC			TWA TWS	TWM	TCH	THH			
DSCC*					DSCC 93026 DSCC 13017						
MIL-PRF*		CWR15			M39006						
Space Level*		TBC SRC9000			TWC SRW9000 TWS SRW9000	TWM	TCH				
Medical*		TBC HRC5000 TBC HRC6000 T4C HRC4000									

*See High Reliability Tantalum Catalog

NOTE: For specific requirements please contact manufacturer

Under development

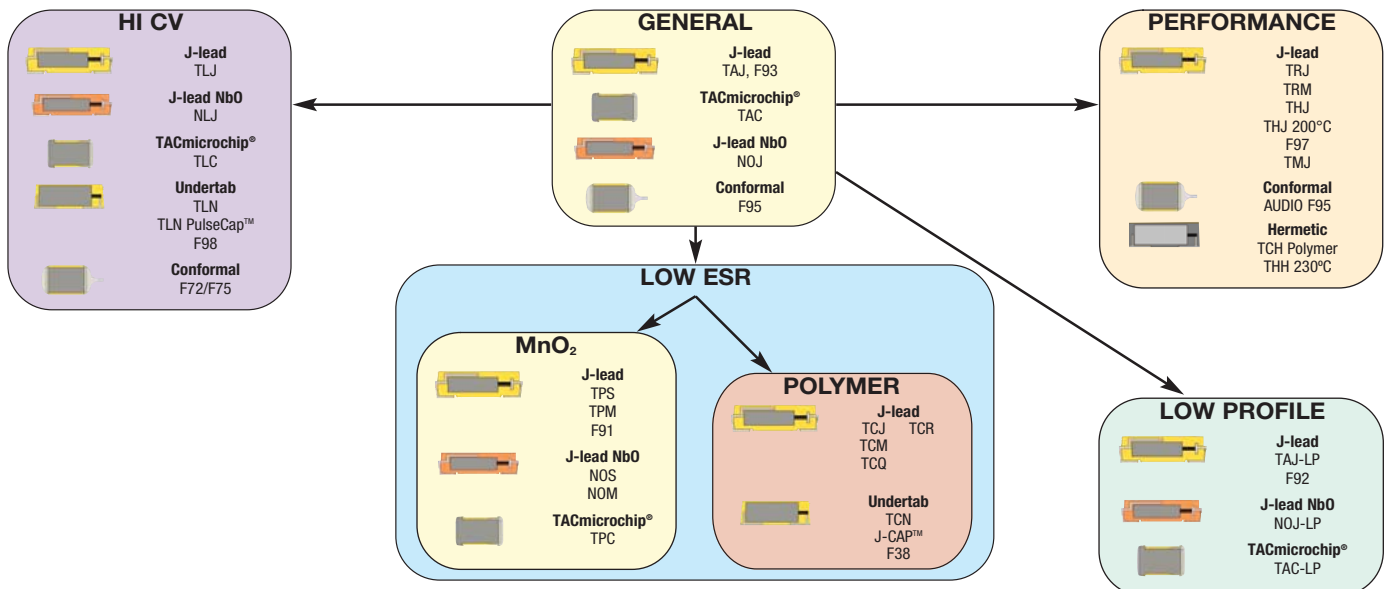

Standard and Low Profile Tantalum Capacitors

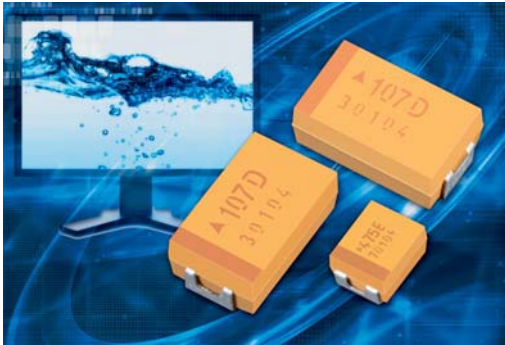

FEATURES

- General purpose SMT chip tantalum series
- 17 case sizes available, standard and low profile down to 1mm maximum height
- CV range: 0.10 - 2200 μ F / 2.5 - 50V
- J-lead construction

APPLICATIONS

- General low power DC/DC and LDO
- Entertainment / Infotainment systems
- Height restricted design

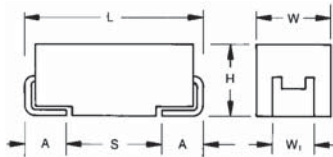

MARKING

A, B, C, D, E, F, H, K, S, T, U, V, W, X, Y CASE

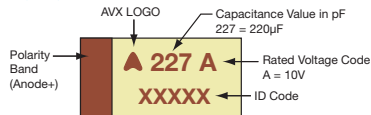

P, R CASE

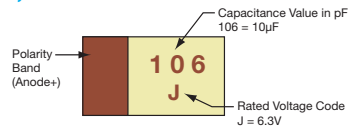

STANDARD CASE DIMENSIONS: millimeters (inches)

Code	EIA Code	EIA Metric	L \pm 0.20 (0.008)	W \pm 0.20 (0.008) -0.10 (0.004)	H \pm 0.20 (0.008) -0.10 (0.004)	W ₁ \pm 0.20 (0.008)	A \pm 0.30 (0.012) -0.20 (0.008)	S Min.
A	1206	3216-18	3.20 (0.126)	1.60 (0.063)	1.60 (0.063)	1.20 (0.047)	0.80 (0.031)	1.10 (0.043)
B	1210	3528-21	3.50 (0.138)	2.80 (0.110)	1.90 (0.075)	2.20 (0.087)	0.80 (0.031)	1.40 (0.055)
C	2312	6032-28	6.00 (0.236)	3.20 (0.126)	2.60 (0.102)	2.20 (0.087)	1.30 (0.051)	2.90 (0.114)
D	2917	7343-31	7.30 (0.287)	4.30 (0.169)	2.90 (0.114)	2.40 (0.094)	1.30 (0.051)	4.40 (0.173)
E	2917	7343-43	7.30 (0.287)	4.30 (0.169)	4.10 (0.162)	2.40 (0.094)	1.30 (0.051)	4.40 (0.173)
U	2924	7361-43	7.30 (0.287)	6.10 (0.240)	4.10 (0.162)	3.10 (0.120)	1.30 (0.051)	4.40 (0.173)
V	2924	7361-38	7.30 (0.287)	6.10 (0.240)	3.55 (0.140)	3.10 (0.120)	1.30 (0.051)	4.40 (0.173)

W₁ dimension applies to the termination width for A dimensional area only.

LOW PROFILE CASE DIMENSIONS: millimeters (inches)

Code	EIA Code	EIA Metric	L \pm 0.20 (0.008)	W \pm 0.20 (0.008) -0.10 (0.004)	H Max.	W ₁ \pm 0.20 (0.008)	A \pm 0.30 (0.012) -0.20 (0.008)	S Min.
F	2312	6032-20	6.00 (0.236)	3.20 (0.126)	2.00 (0.079)	2.20 (0.087)	1.30 (0.051)	2.90 (0.114)
H	1210	3528-15	3.50 (0.138)	2.80 (0.110)	1.50 (0.059)	2.20 (0.087)	0.80 (0.031)	1.40 (0.055)
K	1206	3216-10	3.20 (0.126)	1.60 (0.063)	1.00 (0.039)	1.20 (0.047)	0.80 (0.031)	1.10 (0.043)
P	0805	2012-15	2.05 (0.081)	1.35 (0.053)	1.50 (0.059)	1.00 \pm 0.10 (0.039 \pm 0.004)	0.50 (0.020)	0.85 (0.033)
R	0805	2012-12	2.05 (0.081)	1.30 (0.051)	1.20 (0.047)	1.00 \pm 0.10 (0.039 \pm 0.004)	0.50 (0.020)	0.85 (0.033)
S	1206	3216-12	3.20 (0.126)	1.60 (0.063)	1.20 (0.047)	1.20 (0.047)	0.80 (0.031)	1.10 (0.043)
T	1210	3528-12	3.50 (0.138)	2.80 (0.110)	1.20 (0.047)	2.20 (0.087)	0.80 (0.031)	1.40 (0.055)
W	2312	6032-15	6.00 (0.236)	3.20 (0.126)	1.50 (0.059)	2.20 (0.087)	1.30 (0.051)	2.90 (0.114)
X	2917	7343-15	7.30 (0.287)	4.30 (0.169)	1.50 (0.059)	2.40 (0.094)	1.30 (0.051)	4.40 (0.173)
Y	2917	7343-20	7.30 (0.287)	4.30 (0.169)	2.00 (0.079)	2.40 (0.094)	1.30 (0.051)	4.40 (0.173)

W₁ dimension applies to the termination width for A dimensional area only.

HOW TO ORDER

TAJ	C	106	M	035	R	NJ	-
Type	Case Size See table above	Capacitance Code pF code: 1st two digits represent significant figures 3rd digit represents multiplier (number of zeros to follow)	Tolerance K = \pm 10% M = \pm 20%	Rated DC Voltage 002 = 2.5Vdc 004 = 4Vdc 006 = 6.3Vdc 010 = 10Vdc 016 = 16Vdc 020 = 20Vdc 025 = 25Vdc 035 = 35Vdc 050 = 50Vdc	Packaging R = Pure Tin 7" Reel S = Pure Tin 13" Reel A = Gold Plating 7" Reel B = Gold Plating 13" Reel H = Tin Lead 7" Reel K = Tin Lead 13" Reel H, K = Non RoHS A, B, H, K = please contact manufacturer	Specification Suffix NJ = Standard Suffix	Additional characters may be added for special requirements V = Dry pack Option (selected ratings only)

TECHNICAL SPECIFICATIONS

Technical Data:	All technical data relate to an ambient temperature of +25°C									
Capacitance Range:	0.10 μ F to 2200 μ F									
Capacitance Tolerance:	\pm 10%; \pm 20%									
Rated Voltage (V _R)	\leq +85°C:	2.5	4	6.3	10	16	20	25	35	50
Category Voltage (V _C)	\leq +125°C:	1.7	2.7	4	7	10	13	17	23	33
Surge Voltage (V _S)	\leq +85°C:	3.3	5.2	8	13	20	26	32	46	65
Surge Voltage (V _S)	\leq +125°C:	2.2	3.4	5	8	13	16	20	28	40
Temperature Range:	-55°C to +125°C									
Reliability:	1% per 1000 hours at 85°C, V _R with 0.1 Ω /V series impedance, 60% confidence level									
Qualification:	CECC 30801 - 005 issue 2 EIA 535BAAC for standard case sizes									
Termination Finished:	Sn Plating (standard), Gold and SnPb Plating upon request									
	For AEC-Q200 availability, please contact AVX									

Standard and Low Profile Tantalum Capacitors

STANDARD TANTALUMS CAPACITANCE AND RATED VOLTAGE RANGE (LETTER DENOTES CASE SIZE)

Capacitance		Rated voltage DC (V _R) to 85°C								
µF	Code	2.5V (e)	4V (G)	6.3V (J)	10V (A)	16V (C)	20V (D)	25V (E)	35V (V)	50V (T)
0.10	104								A	A
0.15	154								A	A/B
0.22	224								A	A/B
0.33	334							A	A	A/B
0.47	474						A	A	A/B	A/B/C
0.68	684						A	A	A/B	A/B/C
1.0	105					A	A	A	A/B	A/B/C
1.5	155				A	A	A	A/B	A/B/C	B/C/D
2.2	225			A	A	A/B	A/B	A/B	A/B/C	B/C/D
3.3	335			A	A	A/B	A/B	A/B/C	B/C	C/D
4.7	475		A	A	A/B	A/B	A/B/C	A/B/C	B/C/D	C/D
6.8	685		A	A/B	A/B	A/B/C	A/B/C	A/B/C	C/D	C/D
10	106		A	A/B	A/B/C	A/B/C	A ^(M) /B/C	B/C/D	C/D/E	D/E/V
15	156		A/B	A/B	A/B/C	A/B/C	B/C/D	C/D	C/D	D/E/V
22	226		A	A/B/C	A/B/C	B/C/D	B/C/D	C/D	D/E	V
33	336	A	A/B	A/B/C	A/B/C/D	B/C/D	C/D	C/D/E	D/E/V	
47	476	A	A/B	A/B/C/D	B/C/D	C/D	C/D/E	D/E	E/V	
68	686	A	A/B/C	B/C/D	B/C/D	C/D	C ^(M) /D/E	D/E/V	V	
100	107	A/B	A/B/C	B/C/D	B/C/D/E	C/D/E	D/E/V	E/V		
150	157	B	B/C	B ^(M) /C/D	C/D/E	D/E/V	E/V	V ^(M)		
220	227	B/D	B/C/D	C/D/E	C/D/E	E/V				
330	337	D	C/D/E	C/D/E	D/E/V	E ^(M)				
470	477	C/D	C/D/E	D/E/V	E/U/V					
680	687	C/D/E	D/E	E/V	E ^(M) /V ^(M)					
1000	108	D ^(M) /E	D/E/V	E ^(M) /V ^(M)						
1500	158	D/E/V ^(M)	E/V ^(M)							
2200	228	V ^(M)								

LOW PROFILE TANTALUMS CAPACITANCE AND RATED VOLTAGE RANGE (LETTER DENOTES CASE SIZE)

Capacitance		Rated voltage DC (V _R) to 85°C								
µF	Code	2.5V (e)	4V (G)	6.3V (J)	10V (A)	16V (C)	20V (D)	25V (E)	35V (V)	50V (T)
0.10	104						R/S		R/S	S
0.15	154						R/S	R	R/S	S
0.22	224						R/S	R	R/S	P/R/S
0.33	334						R/S	R	R/S	P/R ^(M) /S/T
0.47	474						R/S	R/S	R/S/T	S/T
0.68	684					R/S	R/S/T	R/S	P/S/T	
1.0	105				R/S	R/S/T	R/S/T	P/R/S	P/S/T	W
1.5	155				R/S	R/S	P/R/S/T	P/S/T	T	W
2.2	225		R/S	R/S	R/S	R/S/T	P/R/S/T	T	T	W
3.3	335		R/S	R/S	R/S/T	R/S/T	T	T/W	W	Y
4.7	475	R	R/S	R/S/T	R/S/T	K/P/S/T	T	T/W	W	X/Y
6.8	685	R	R/S/T	R/S/T	P/R/S/T	S/T	T	W	Y	Y
10	106	R/S	R/S/T	P/R/S/T	K/P/R ^(M) /S/T	T/W	W	W	X/Y	
15	156	R	R/S/T	K/P/R/S/T	S/T/W	T ^(M) /W	W	Y	Y	
22	226	P/R	K/P/R/S/T	K/P ^(M) /S/T/W	T/W	W	W/Y	F/Y	Y	
33	336	K/P/S	K/P ^(M) /S/T/W	T/W	W	W/Y	X/Y	Y		
47	476	P ^(M) /S	T/W	T/W	H/W/Y	W/X/Y	X/Y	Y		
68	686	T	T/W	W	W/Y	F/X/Y	Y			
100	107	T/W	T ^(M) /W	W/Y	W/X/Y	F ^(M) /Y				
150	157	T ^(M) /W	W/Y	W/X/Y	F/X ^(M) /Y	Y ^(M)				
220	227	W/Y	W/X/Y	F/X/Y	Y					
330	337	W ^(M) /Y	F/X/Y	Y						
470	477	F/Y	Y	Y						
680	687	Y	Y ^(M)							
1000	108	Y ^(M)								

Not recommended for new designs; higher voltage or smaller case size alternatives are available.

Released ratings ^(M tolerance only)

Engineering samples - please contact AVX

*Ratings under development - subject to change

Note: Voltage ratings are minimum values. AVX reserves the right to supply higher voltage ratings in the same case size, to the same reliability standards.

RATINGS & PART NUMBER REFERENCE

AVX Part No.	Case Size	Capacitance (µF)	Rated Voltage (V)	Rated Temperature (°C)	Category Voltage (V)	Category Temperature (°C)	DCL Max. (µA)	DF Max. (%)	ESR Max. @ 100kHz (Ω)	MSL	100kHz RMS Current (mA)		
											25°C	85°C	125°C
2.5 Volt @ 85°C													
TAJR475*002#NJ	R	4.7	2.5	85	1.7	125	0.5	6	20	1	52	47	21
TAJR685*002#NJ	R	6.8	2.5	85	1.7	125	0.5	6	20	1	52	47	21
TAJR106*002#NJ	R	10	2.5	85	1.7	125	0.5	8	4.5	1	111	99	44
TAJS106*002#NJ	S	10	2.5	85	1.7	125	0.5	6	8	1	90	81	36
TAJR156*002#NJ	R	15	2.5	85	1.7	125	0.5	8	4.1	1	116	104	46
TAJP226*002#NJ	P	22	2.5	85	1.7	125	0.5	8	3.5	1	131	118	52
TAJR226*002#NJ	R	22	2.5	85	1.7	125	0.5	8	3.8	1	120	108	48
TAJA336*002#NJ	A	33	2.5	85	1.7	125	0.8	8	1.7	1	210	189	84
TAJK336*002#NJ	K	33	2.5	85	1.7	125	0.8	8	1.7	1	188	169	75
TAJP336*002#NJ	P	33	2.5	85	1.7	125	0.7	8	3.5	1	131	118	52
TAJS336*002#NJ	S	33	2.5	85	1.7	125	0.7	8	1.5	1	208	187	83
TAJA476*002#NJ	A	47	2.5	85	1.7	125	0.9	6	3	1	158	142	63
TAJP476M002#NJ	P	47	2.5	85	1.7	125	1.2	12	3.2	1	137	123	55
TAJS476*002#NJ	S	47	2.5	85	1.7	125	1.2	8	1.6	1	202	181	81
TAJA686*002#NJ	A	68	2.5	85	1.7	125	1.4	8	1.5	1	224	201	89
TAJT686*002#NJ	T	68	2.5	85	1.7	125	1.4	8	1.5	1	231	208	92
TAJA107*002#NJ	A	100	2.5	85	1.7	125	2.5	30	1.4	1	231	208	93
TAJB107*002#NJ	B	100	2.5	85	1.7	125	2.5	8	1.4	1	246	222	99
TAJT107*002#NJ	T	100	2.5	85	1.7	125	2.5	15	1.3	1	248	223	99
TAJW107*002#NJ	W	100	2.5	85	1.7	125	2.5	8	0.4	1	474	427	190
TAJB157*002#NJ	B	150	2.5	85	1.7	125	3	10	1.6	1	230	207	92
TAJT157M002#NJ	T	150	2.5	85	1.7	125	3.8	18	1.2	1	258	232	103
TAJW157*002#NJ	W	150	2.5	85	1.7	125	3.8	8	0.3	1	548	493	219
TAJB227*002#NJ	B	220	2.5	85	1.7	125	4.4	16	1.6	1	230	207	92
TAJD227*002#NJ	D	220	2.5	85	1.7	125	5.5	8	0.3	1	707	636	283
TAJW227*002#NJ	W	220	2.5	85	1.7	125	5.5	8	0.3	1	548	493	219
TAJY227*002#NJ	Y	220	2.5	85	1.7	125	5.5	8	0.3	1 ¹⁾	645	581	258
TAJD337*002#NJ	D	330	2.5	85	1.7	125	8.2	8	0.3	1	707	636	283
TAJW337M002#NJ	W	330	2.5	85	1.7	125	8.2	12	0.3	1	548	493	219
TAJY337*002#NJ	Y	330	2.5	85	1.7	125	8.2	8	0.3	1 ¹⁾	645	581	258
TAJC477*002#NJ	C	470	2.5	85	1.7	125	9.4	12	0.2	1	742	667	297
TAJD477*002#NJ	D	470	2.5	85	1.7	125	11.6	8	0.2	1	866	779	346
TAJF477*002#NJ	F	470	2.5	85	1.7	125	11.8	12	0.3	1	577	520	231
TAJY477*002#NJ	Y	470	2.5	85	1.7	125	11	12	0.2	1 ¹⁾	791	712	316
TAJC687*002#NJ	C	680	2.5	85	1.7	125	17	18	0.2	1	742	667	297
TAJD687*002#NJ	D	680	2.5	85	1.7	125	17	16	0.2	1	866	779	346
TAJE687*002#NJ	E	680	2.5	85	1.7	125	17	10	0.2	1 ¹⁾	908	817	363
TAJY687*002#NJ	Y	680	2.5	85	1.7	125	17	12	0.2	1 ¹⁾	791	712	316
TAJD108M002#NJ	D	1000	2.5	85	1.7	125	25	20	0.2	1	866	779	346
TAJE108*002#NJ	E	1000	2.5	85	1.7	125	20	14	0.4	1 ¹⁾	642	578	257
TAJY108M002#NJ	Y	1000	2.5	85	1.7	125	25	30	0.2	1 ¹⁾	791	712	316
TAJD158*002#NJ	D	1500	2.5	85	1.7	125	37.5	60	0.2	1	866	779	346
TAJE158*002#NJ	E	1500	2.5	85	1.7	125	37	20	0.2	1 ¹⁾	908	817	363
TAJV158M002#NJ	V	1500	2.5	85	1.7	125	30	20	0.2	1 ¹⁾	1118	1006	447
TAJV228M002#NJ	V	2200	2.5	85	1.7	125	55	50	0.2	1 ¹⁾	1118	1006	447
4 Volt @ 85°C													
TAJR225*004#NJ	R	2.2	4	85	2.7	125	0.5	6	25	1	47	42	19
TAJS225*004#NJ	S	2.2	4	85	2.7	125	0.5	6	25	1	51	46	20
TAJR335*004#NJ	R	3.3	4	85	2.7	125	0.5	6	20	1	52	47	21
TAJS335*004#NJ	S	3.3	4	85	2.7	125	0.5	6	18	1	60	54	24
TAJR475*004#NJ	R	4.7	4	85	2.7	125	0.5	6	12	1	68	61	27
TAJS475*004#NJ	S	4.7	4	85	2.7	125	0.5	6	10	1	81	73	32
TAJR685*004#NJ	R	6.8	4	85	2.7	125	0.5	6	5.2	1	103	93	41
TAJS685*004#NJ	S	6.8	4	85	2.7	125	0.5	6	8	1	90	81	36
TAJT685*004#NJ	T	6.8	4	85	2.7	125	0.5	6	6	1	115	104	46
TAJR106*004#NJ	R	10	4	85	2.7	125	0.5	6	7	1	89	80	35
TAJS106*004#NJ	S	10	4	85	2.7	125	0.5	6	6	1	104	94	42
TAJT106*004#NJ	T	10	4	85	2.7	125	0.5	6	5	1	126	114	51
TAJR156*004#NJ	R	15	4	85	2.7	125	0.6	8	4	1	117	106	47
TAJS156*004#NJ	S	15	4	85	2.7	125	0.6	8	4	1	127	115	51
TAJT156*004#NJ	T	15	4	85	2.7	125	0.6	6	2	1	200	180	80
TAJK226*004#NJ	K	22	4	85	2.7	125	0.9	8	1.8	1	183	164	73
TAJP226*004#NJ	P	22	4	85	2.7	125	0.9	8	4	1	122	110	49
TAJR226*004#NJ	R	22	4	85	2.7	125	0.9	8	3.8	1	120	108	48
TAJS226*004#NJ	S	22	4	85	2.7	125	0.9	8	3.5	1	136	123	55
TAJT226*004#NJ	T	22	4	85	2.7	125	0.9	6	1.9	1	205	185	82
TAJA336*004#NJ	A	33	4	85	2.7	125	1.3	6	3	1	158	142	63
TAJK336*004#NJ	K	33	4	85	2.7	125	1.3	10	1.7	1	188	169	75
TAJP336M004#NJ	P	33	4	85	2.7	125	1.3	8	2.8	1	146	132	59
TAJS336*004#NJ	S	33	4	85	2.7	125	1.3	8	1.7	1	196	176	78

RATINGS & PART NUMBER REFERENCE

AVX Part No.	Case Size	Capacitance (µF)	Rated Voltage (V)	Rated Temperature (°C)	Category Voltage (V)	Category Temperature (°C)	DCL Max. (µA)	DF Max. (%)	ESR Max. @ 100kHz (Ω)	MSL	100kHz RMS Current (mA)		
											25°C	85°C	125°C
TAJT336*004#NJ	T	33	4	85	2.7	125	1.3	6	1.7	1	217	195	87
TAJW336*004#NJ	W	33	4	85	2.7	125	1.3	6	0.6	1	387	349	155
TAJA476*004#NJ	A	47	4	85	2.7	125	1.9	8	2.6	1	170	153	68
TAJT476*004#NJ	T	47	4	85	2.7	125	1.9	10	1.6	1	224	201	89
TAJW476*004#NJ	W	47	4	85	2.7	125	1.9	6	0.5	1	424	382	170
TAJA686*004#NJ	A	68	4	85	2.7	125	2.7	10	1.5	1	224	201	89
TAJB686*004#NJ	B	68	4	85	2.7	125	2.7	6	1.8	1	217	196	87
TAJT686*004#NJ	T	68	4	85	2.7	125	2.7	15	1.5	1	231	208	92
TAJW686*004#NJ	W	68	4	85	2.7	125	2.7	6	0.4	1	474	427	190
TAJA107*004#NJ	A	100	4	85	2.7	125	4	30	1.4	1	231	208	93
TAJB107*004#NJ	B	100	4	85	2.7	125	4	8	0.9	1	307	277	123
TAJT107M004#NJ	T	100	4	85	2.7	125	4	14	1.4	1	239	215	96
TAJW107*004#NJ	W	100	4	85	2.7	125	4	6	0.4	1	474	427	190
TAJB157*004#NJ	B	150	4	85	2.7	125	6	10	1.5	1	238	214	95
TAJC157*004#NJ	C	150	4	85	2.7	125	6	6	0.3	1	606	545	242
TAJW157*004#NJ	W	150	4	85	2.7	125	6	6	0.5	1	424	382	170
TAJY157*004#NJ	Y	150	4	85	2.7	125	6	6	0.4	1 ¹⁾	559	503	224
TAJB227*004#NJ	B	220	4	85	2.7	125	8.8	12	1.1	1	278	250	111
TAJC227*004#NJ	C	220	4	85	2.7	125	8.8	8	1.2	1	303	272	121
TAJD227*004#NJ	D	220	4	85	2.7	125	8.8	8	0.9	1	408	367	163
TAJW227*004#NJ	W	220	4	85	2.7	125	8.8	8	0.3	1	548	493	219
TAJX227*004#NJ	X	220	4	85	2.7	125	8.8	8	0.9	1 ¹⁾	577	520	231
TAJY227*004#NJ	Y	220	4	85	2.7	125	8.8	8	0.3	1 ¹⁾	645	581	258
TAJC337*004#NJ	C	330	4	85	2.7	125	13.2	8	0.3	1	606	545	242
TAJD337*004#NJ	D	330	4	85	2.7	125	13.2	8	0.9	1	408	367	163
TAJF337*004#NJ	F	330	4	85	2.7	125	13.2	10	0.3	1	577	520	231
TAJX337*004#NJ	X	330	4	85	2.7	125	13.2	8	0.3	1 ¹⁾	577	520	231
TAJY337*004#NJ	Y	330	4	85	2.7	125	13.2	12	0.4	1 ¹⁾	559	503	224
TAJC477*004#NJ	C	470	4	85	2.7	125	18.8	14	0.3	1	606	545	242
TAJD477*004#NJ	D	470	4	85	2.7	125	18.8	12	0.9	1	408	367	163
TAJE477*004#NJ	E	470	4	85	2.7	125	18.8	10	0.5	1 ¹⁾	574	517	230
TAJY477*004#NJ	Y	470	4	85	2.7	125	18.8	14	0.4	1 ¹⁾	559	503	224
TAJD687*004#NJ	D	680	4	85	2.7	125	27.2	14	0.5	1	548	493	219
TAJE687*004#NJ	E	680	4	85	2.7	125	27.2	14	0.9	1 ¹⁾	428	385	171
TAJY687M004#NJ	Y	680	4	85	2.7	125	27.2	25	0.2	1 ¹⁾	791	712	316
TAJD108*004#NJ	D	1000	4	85	2.7	125	40	60	0.2	1	866	779	346
TAJE108*004#NJ	E	1000	4	85	2.7	125	40	14	0.4	1 ¹⁾	642	578	257
TAJV108*004#NJ	V	1000	4	85	2.7	125	40	16	0.2	1 ¹⁾	1118	1006	447
TAJE158*004#NJ	E	1500	4	85	2.7	125	60	30	0.2	1 ¹⁾	908	817	363
TAJV158M004#NJ	V	1500	4	85	2.7	125	60	30	0.2	1 ¹⁾	1118	1006	447
6.3 Volt @ 85°C													
TAJR155*006#NJ	R	1.5	6.3	85	4	125	0.5	6	25	1	47	42	19
TAJS155*006#NJ	S	1.5	6.3	85	4	125	0.5	6	25	1	51	46	20
TAJR225*006#NJ	R	2.2	6.3	85	4	125	0.5	6	20	1	52	47	21
TAJS225*006#NJ	S	2.2	6.3	85	4	125	0.5	6	18	1	60	54	24
TAJR335*006#NJ	R	3.3	6.3	85	4	125	0.5	6	12	1	68	61	27
TAJS335*006#NJ	S	3.3	6.3	85	4	125	0.5	6	9	1	85	76	34
TAJR475*006#NJ	R	4.7	6.3	85	4	125	0.5	6	7	1	89	80	35
TAJS475*006#NJ	S	4.7	6.3	85	4	125	0.5	6	7.5	1	93	84	37
TAJT475*006#NJ	T	4.7	6.3	85	4	125	0.5	6	6	1	115	104	46
TAJR685*006#NJ	R	6.8	6.3	85	4	125	0.5	8	7	1	89	80	35
TAJS685*006#NJ	S	6.8	6.3	85	4	125	0.5	6	2.6	1	158	142	63
TAJT685*006#NJ	T	6.8	6.3	85	4	125	0.5	6	5	1	126	114	51
TAJA106*006#NJ	A	10	6.3	85	4	125	0.6	6	4	1	137	123	55
TAJP106*006#NJ	P	10	6.3	85	4	125	0.6	8	6	1	100	90	40
TAJR106*006#NJ	R	10	6.3	85	4	125	0.6	8	6	1	96	86	38
TAJS106*006#NJ	S	10	6.3	85	4	125	0.6	8	4	1	127	115	51
TAJT106*006#NJ	T	10	6.3	85	4	125	0.6	6	4	1	141	127	57
TAJA156*006#NJ	A	15	6.3	85	4	125	0.9	6	3.5	1	146	132	59
TAJK156*006#NJ	K	15	6.3	85	4	125	0.9	6	2	1	173	156	69
TAJP156*006#NJ	P	15	6.3	85	4	125	0.9	8	3.5	1	131	118	52
TAJR156*006#NJ	R	15	6.3	85	4	125	0.9	8	4.1	1	116	104	46
TAJS156*006#NJ	S	15	6.3	85	4	125	0.9	8	3.5	1	136	123	55
TAJT156*006#NJ	T	15	6.3	85	4	125	0.9	6	3.5	1	151	136	60
TAJA226*006#NJ	A	22	6.3	85	4	125	1.4	6	3	1	158	142	63
TAJK226*006#NJ	K	22	6.3	85	4	125	1.3	10	1.8	1	183	164	73
TAJP226M006#NJ	P	22	6.3	85	4	125	1.3	8	3.3	1	135	121	54
TAJS226*006#NJ	S	22	6.3	85	4	125	1.3	10	1.8	1	190	171	76
TAJT226*006#NJ	T	22	6.3	85	4	125	1.4	8	2.5	1	179	161	72
TAJW226*006#NJ	W	22	6.3	85	4	125	1.3	6	0.6	1	387	349	155
TAJA336*006#NJ	A	33	6.3	85	4	125	2.1	8	2.2	1	185	166	74

TAJ Series



Standard and Low Profile Tantalum Capacitors

RATINGS & PART NUMBER REFERENCE

AVX Part No.	Case Size	Capacitance (µF)	Rated Voltage (V)	Rated Temperature (°C)	Category Voltage (V)	Category Temperature (°C)	DCL Max. (µA)	DF Max. (%)	ESR Max. @ 100kHz (Ω)	MSL	100kHz RMS Current (mA)		
											25°C	85°C	125°C
TAJT336*006#NJ	T	33	6.3	85	4	125	2.1	10	2.5	1	179	161	72
TAJW336*006#NJ	W	33	6.3	85	4	125	2	6	0.5	1	424	382	170
TAJA476*006#NJ	A	47	6.3	85	4	125	2.8	10	1.6	1	217	195	87
TAJB476*006#NJ	B	47	6.3	85	4	125	3	6	2	1	206	186	82
TAJC476*006#NJ	C	47	6.3	85	4	125	3	6	1.6	1	262	236	105
TAJT476*006#NJ	T	47	6.3	85	4	125	2.8	10	1.6	1	224	201	89
TAJW476*006#NJ	W	47	6.3	85	4	125	2.8	6	0.5	1	424	382	170
TAJB686*006#NJ	B	68	6.3	85	4	125	4	8	0.9	1	307	277	123
TAJC686*006#NJ	C	68	6.3	85	4	125	4.3	6	1.5	1	271	244	108
TAJW686*006#NJ	W	68	6.3	85	4	125	4.3	6	1.5	1	245	220	98
TAJB107*006#NJ	B	100	6.3	85	4	125	6.3	10	1.7	1	224	201	89
TAJC107*006#NJ	C	100	6.3	85	4	125	6.3	6	0.9	1	350	315	140
TAJW107*006#NJ	W	100	6.3	85	4	125	6.3	6	0.9	1	316	285	126
TAJY107*006#NJ	Y	100	6.3	85	4	125	6.3	6	0.7	1 ¹⁾	423	380	169
TAJB157M006#NJ	B	150	6.3	85	4	125	9.5	10	1.2	1	266	240	106
TAJC157*006#NJ	C	150	6.3	85	4	125	9.5	6	1.3	1	291	262	116
TAJD157*006#NJ	D	150	6.3	85	4	125	9.5	6	0.9	1	408	367	163
TAJW157*006#NJ	W	150	6.3	85	4	125	9	8	0.3	1	548	493	219
TAJX157*006#NJ	X	150	6.3	85	4	125	9	6	0.4	1 ¹⁾	500	450	200
TAJY157*006#NJ	Y	150	6.3	85	4	125	9.5	6	0.4	1 ¹⁾	559	503	224
TAJC227*006#NJ	C	220	6.3	85	4	125	13.9	8	1.2	1	303	272	121
TAJD227*006#NJ	D	220	6.3	85	4	125	13.9	8	0.4	1	612	551	245
TAJE227*006#NJ	E	220	6.3	85	4	125	13.9	8	0.4	1 ¹⁾	642	578	257
TAJF227*006#NJ	F	220	6.3	85	4	125	13.2	10	0.3	1	577	520	231
TAJX227*006#NJ	X	220	6.3	85	4	125	13.2	8	0.3	1 ¹⁾	577	520	231
TAJY227*006#NJ	Y	220	6.3	85	4	125	13.9	8	0.7	1 ¹⁾	423	380	169
TAJC337*006#NJ	C	330	6.3	85	4	125	19.8	12	0.5	1	469	422	188
TAJD337*006#NJ	D	330	6.3	85	4	125	20.8	8	0.4	1	612	551	245
TAJE337*006#NJ	E	330	6.3	85	4	125	20.8	8	0.4	1 ¹⁾	642	578	257
TAJY337*006#NJ	Y	330	6.3	85	4	125	20.8	12	0.4	1 ¹⁾	559	503	224
TAJD477*006#NJ	D	470	6.3	85	4	125	28	12	0.4	1	612	551	245
TAJE477*006#NJ	E	470	6.3	85	4	125	28	10	0.4	1 ¹⁾	642	578	257
TAJV477*006#NJ	V	470	6.3	85	4	125	28	10	0.4	1 ¹⁾	791	712	316
TAJY477*006#NJ	Y	470	6.3	85	4	125	28.2	20	0.2	1 ¹⁾	791	712	316
TAJE687*006#NJ	E	680	6.3	85	4	125	42.8	10	0.5	1 ¹⁾	574	517	230
TAJV687*006#NJ	V	680	6.3	85	4	125	42.8	10	0.5	1 ¹⁾	707	636	283
TAJE108M006#NJ	E	1000	6.3	85	4	125	60	20	0.2	1 ¹⁾	908	817	363
TAJV108M006#NJ	V	1000	6.3	85	4	125	60	16	0.2	1 ¹⁾	1118	1006	447
10 Volt @ 85°C													
TAJR105*010#NJ	R	1	10	85	7	125	0.5	4	25	1	47	42	19
TAJS105*010#NJ	S	1	10	85	7	125	0.5	4	25	1	51	46	20
TAJR155*010#NJ	R	1.5	10	85	7	125	0.5	6	20	1	52	47	21
TAJS155*010#NJ	S	1.5	10	85	7	125	0.5	6	20	1	57	51	23
TAJR225*010#NJ	R	2.2	10	85	7	125	0.5	6	15	1	61	54	24
TAJS225*010#NJ	S	2.2	10	85	7	125	0.5	6	12	1	74	66	29
TAJR335*010#NJ	R	3.3	10	85	7	125	0.5	6	8	1	83	75	33
TAJS335*010#NJ	S	3.3	10	85	7	125	0.5	6	8	1	90	81	36
TAJT335*010#NJ	T	3.3	10	85	7	125	0.5	6	6	1	115	104	46
TAJA475*010#NJ	A	4.7	10	85	7	125	0.5	6	5	1	122	110	49
TAJR475*010#NJ	R	4.7	10	85	7	125	0.5	6	9	1	78	70	31
TAJS475*010#NJ	S	4.7	10	85	7	125	0.5	6	5	1	114	103	46
TAJT475*010#NJ	T	4.7	10	85	7	125	0.5	6	5	1	126	114	51
TAJA685*010#NJ	A	6.8	10	85	7	125	0.7	6	4	1	137	123	55
TAJP685*010#NJ	P	6.8	10	85	7	125	0.6	6	5	1	110	99	44
TAJR685*010#NJ	R	6.8	10	85	7	125	0.7	6	5.2	1	103	93	41
TAJS685*010#NJ	S	6.8	10	85	7	125	0.7	6	4	1	127	115	51
TAJT685*010#NJ	T	6.8	10	85	7	125	0.7	6	4	1	141	127	57
TAJA106*010#NJ	A	10	10	85	7	125	1	6	3	1	158	142	63
TAJK106*010#NJ	K	10	10	85	7	125	1	6	2.2	1	165	149	66
TAJP106*010#NJ	P	10	10	85	7	125	1	8	6	1	100	90	40
TAJR106M010#NJ	R	10	10	85	7	125	1	20	6	1	96	86	38
TAJS106*010#NJ	S	10	10	85	7	125	1	8	3	1	147	132	59
TAJT106*010#NJ	T	10	10	85	7	125	1	6	3	1	163	147	65
TAJA156*010#NJ	A	15	10	85	7	125	1.5	6	3.2	1	153	138	61
TAJB156*010#NJ	B	15	10	85	7	125	1.5	6	2.8	1	174	157	70
TAJS156*010#NJ	S	15	10	85	7	125	1.5	6	2	1	180	162	72
TAJT156*010#NJ	T	15	10	85	7	125	1.5	8	2.8	1	169	152	68
TAJW156*010#NJ	W	15	10	85	7	125	1.5	6	0.7	1	359	323	143
TAJA226*010#NJ	A	22	10	85	7	125	2.2	8	3	1	158	142	63
TAJB226*010#NJ	B	22	10	85	7	125	2.2	6	2.4	1	188	169	75
TAJT226*010#NJ	T	22	10	85	7	125	2.2	8	2.2	1	191	172	76

RATINGS & PART NUMBER REFERENCE

AVX Part No.	Case Size	Capacitance (µF)	Rated Voltage (V)	Rated Temperature (°C)	Category Voltage (V)	Category Temperature (°C)	DCL Max. (µA)	DF Max. (%)	ESR Max. @ 100kHz (Ω)	MSL	100kHz RMS Current (mA)		
											25°C	85°C	125°C
TAJW226*010#NJ	W	22	10	85	7	125	2.2	6	0.6	1	387	349	155
TAJA336*010#NJ	A	33	10	85	7	125	3.3	8	1.7	1	210	189	84
TAJB336*010#NJ	B	33	10	85	7	125	3.3	6	1.8	1	217	196	87
TAJC336*010#NJ	C	33	10	85	7	125	3.3	6	1.6	1	262	236	105
TAJW336*010#NJ	W	33	10	85	7	125	3.3	6	1.6	1	237	213	95
TAJB476*010#NJ	B	47	10	85	7	125	4.7	8	1	1	292	262	117
TAJC476*010#NJ	C	47	10	85	7	125	4.7	6	1.2	1	303	272	121
TAJH476*006#NJ	H	47	10	85	7	125	4.7	8	1.0	1	283	255	113
TAJW476*010#NJ	W	47	10	85	7	125	4.7	6	1.4	1	254	228	101
TAJY476*010#NJ	Y	47	10	85	7	125	4.7	6	0.5 1 ¹⁾		500	450	200
TAJB686*010#NJ	B	68	10	85	7	125	6.8	6	1.4	1	246	222	99
TAJC686*010#NJ	C	68	10	85	7	125	6.8	6	1.3	1	291	262	116
TAJW686*010#NJ	W	68	10	85	7	125	6.8	6	1.2	1	274	246	110
TAJY686*010#NJ	Y	68	10	85	7	125	6.8	6	0.9 1 ¹⁾		373	335	149
TAJB107*010#NJ	B	100	10	85	7	125	10	8	1.4	1	246	222	99
TAJC107*010#NJ	C	100	10	85	7	125	10	8	1.2	1	303	272	121
TAJD107*010#NJ	D	100	10	85	7	125	10	6	0.9 1		408	367	163
TAJW107*010#NJ	W	100	10	85	7	125	10	6	0.4 1		474	427	190
TAJX107*010#NJ	X	100	10	85	7	125	10	8	0.9 1 ¹⁾		333	300	133
TAJY107*010#NJ	Y	100	10	85	7	125	10	6	0.9 1 ¹⁾		373	335	149
TAJC157*010#NJ	C	150	10	85	7	125	15	8	0.9 1		350	315	140
TAJD157*010#NJ	D	150	10	85	7	125	15	8	0.9 1		408	367	163
TAJE157*010#NJ	E	150	10	85	7	125	15	8	0.9 1 ¹⁾		428	385	171
TAJF157*010#NJ	F	150	10	85	7	125	15	10	0.3 1		577	520	231
TAJX157M010#NJ	X	150	10	85	7	125	15	6	0.3 1 ¹⁾		577	520	231
TAJY157*010#NJ	Y	150	10	85	7	125	15	6	1.2 1 ¹⁾		323	290	129
TAJC227*010#NJ	C	220	10	85	7	125	22	16	0.5 1		469	422	188
TAJD227*010#NJ	D	220	10	85	7	125	22	8	0.5 1		548	493	219
TAJE227*010#NJ	E	220	10	85	7	125	22	8	0.5 1 ¹⁾		574	517	230
TAJY227*010#NJ	Y	220	10	85	7	125	22	10	0.5 1 ¹⁾		500	450	200
TAJD337*010#NJ	D	330	10	85	7	125	33	8	0.9 1		408	367	163
TAJE337*010#NJ	E	330	10	85	7	125	33	8	0.9 1 ¹⁾		428	385	171
TAJV337*010#NJ	V	330	10	85	7	125	33	10	0.9 1 ¹⁾		572	474	211
TAJE477*010#NJ	E	470	10	85	7	125	47	10	0.5 1 ¹⁾		574	517	230
TAJU477*010RNJ	U	470	10	85	7	125	47	12	0.5 1 ¹⁾		574	517	230
TAJV477*010#NJ	V	470	10	85	7	125	47	10	0.5 1 ¹⁾		707	636	283
TAJE687M010#NJ	E	680	10	85	7	125	68	18	0.4 3		642	578	257
TAJV687M010#NJ	V	680	10	85	7	125	68	18	0.4 3		791	712	316
16 Volt @ 85°C													
TAJR684*016#NJ	R	0.68	16	85	10	125	0.5	4	25	1	47	42	19
TAJS684*016#NJ	S	0.68	16	85	10	125	0.5	4	25	1	51	46	20
TAJR105*016#NJ	R	1	16	85	10	125	0.5	4	20	1	52	47	21
TAJS105*016#NJ	S	1	16	85	10	125	0.5	4	15	1	66	59	26
TAJT105*016#NJ	T	1	16	85	10	125	0.5	4	5	1	126	114	51
TAJR155*016#NJ	R	1.5	16	85	10	125	0.5	6	10	1	74	67	30
TAJS155*016#NJ	S	1.5	16	85	10	125	0.5	6	12	1	74	66	29
TAJA225*016#NJ	A	2.2	16	85	10	125	0.5	6	6.5	1	107	97	43
TAJR225*016#NJ	R	2.2	16	85	10	125	0.5	6	6.5	1	92	83	37
TAJS225*016#NJ	S	2.2	16	85	10	125	0.5	6	6	1	104	94	42
TAJT225*016#NJ	T	2.2	16	85	10	125	0.5	6	6.5	1	111	100	44
TAJA335*016#NJ	A	3.3	16	85	10	125	0.5	6	5	1	122	110	49
TAJB335*016#NJ	B	3.3	16	85	10	125	0.5	6	4.5	1	137	124	55
TAJR335*016#NJ	R	3.3	16	85	10	125	0.5	8	5	1	105	94	42
TAJS335*016#NJ	S	3.3	16	85	10	125	0.5	6	5	1	114	103	46
TAJT335*016#NJ	T	3.3	16	85	10	125	0.5	6	5	1	126	114	51
TAJA475*016#NJ	A	4.7	16	85	10	125	0.8	6	4	1	137	123	55
TAJB475*016#NJ	B	4.7	16	85	10	125	0.8	6	3.5	1	156	140	62
TAJK475*016#NJ	K	4.7	16	85	10	125	0.8	6	3.1	1	139	125	56
TAJP475*016#NJ	P	4.7	16	85	10	125	0.8	8	5	1	110	99	44
TAJS475*016#NJ	S	4.7	16	85	10	125	0.8	8	4	1	127	115	51
TAJT475*016#NJ	T	4.7	16	85	10	125	0.8	6	3.1	1	161	145	64
TAJA685*016#NJ	A	6.8	16	85	10	125	1.1	6	3.5	1	146	132	59
TAJB685*016#NJ	B	6.8	16	85	10	125	1.1	6	2.5	1	184	166	74
TAJS685*016#NJ	S	6.8	16	85	10	125	1.1	8	2.4	1	165	148	66
TAJT685*016#NJ	T	6.8	16	85	10	125	1.1	6	3.5	1	151	136	60
TAJA106*016#NJ	A	10	16	85	10	125	1.6	6	3	1	158	142	63
TAJB106*016#NJ	B	10	16	85	10	125	1.6	6	2.8	1	174	157	70
TAJC106*016#NJ	C	10	16	85	10	125	1.6	6	2	1	235	211	94
TAJT106*016#NJ	T	10	16	85	10	125	1.6	8	2.2	1	191	172	76
TAJW106*016#NJ	W	10	16	85	10	125	1.6	6	2	1	212	191	85
TAJA156*016#NJ	A	15	16	85	10	125	2.4	6	2	1	194	174	77

TAJ Series



Standard and Low Profile Tantalum Capacitors

RATINGS & PART NUMBER REFERENCE

AVX Part No.	Case Size	Capacitance (µF)	Rated Voltage (V)	Rated Temperature (°C)	Category Voltage (V)	Category Temperature (°C)	DCL Max. (µA)	DF Max (%)	ESR Max. @ 100kHz (Ω)	MSL	100kHz RMS Current (mA)		
											25°C	85°C	125°C
TAJB156*016#NJ	B	15	16	85	10	125	2.4	6	2.5	1	184	166	74
TAJC156*016#NJ	C	15	16	85	10	125	2.4	6	1.8	1	247	222	99
TAJT156M016#NJ	T	15	16	85	10	125	2.4	6	2	1	200	180	80
TAJW156*016#NJ	W	15	16	85	10	125	2.4	6	0.7	1	359	323	143
TAJB226*016#NJ	B	22	16	85	10	125	3.5	6	2.3	1	192	173	77
TAJC226*016#NJ	C	22	16	85	10	125	3.5	6	1	1	332	298	133
TAJD226*016#NJ	D	22	16	85	10	125	3.5	6	1.1	1	369	332	148
TAJW226*016#NJ	W	22	16	85	10	125	3.5	6	1.6	1	237	213	95
TAJB336*016#NJ	B	33	16	85	10	125	5.3	8	2.1	1	201	181	80
TAJC336*016#NJ	C	33	16	85	10	125	5.3	6	1.5	1	271	244	108
TAJD336*016#NJ	D	33	16	85	10	125	5.3	6	0.9	1	408	367	163
TAJW336*016#NJ	W	33	16	85	10	125	5.3	6	1.5	1	245	220	98
TAJY336*016#NJ	Y	33	16	85	10	125	5.3	6	0.9	1 ¹⁾	373	335	149
TAJC476*016#NJ	C	47	16	85	10	125	7.5	6	0.5	1	469	422	188
TAJD476*016#NJ	D	47	16	85	10	125	7.5	6	0.9	1	408	367	163
TAJW476*016#NJ	W	47	16	85	10	125	7.5	6	0.4	1	474	427	190
TAJX476*016#NJ	X	47	16	85	10	125	7.5	6	0.75	1 ¹⁾	365	329	146
TAJY476*016#NJ	Y	47	16	85	10	125	7.5	6	0.7	1 ¹⁾	423	380	169
TAJC686*016#NJ	C	68	16	85	10	125	10.9	6	1.3	1	291	262	116
TAJD686*016#NJ	D	68	16	85	10	125	10.9	6	0.9	1	408	367	163
TAJF686*016#NJ	F	68	16	85	10	125	10.9	10	0.4	1	500	450	200
TAJX686*016#NJ	X	68	16	85	10	125	10.9	8	0.6	1 ¹⁾	408	367	163
TAJY686*016#NJ	Y	68	16	85	10	125	10.9	6	0.9	1 ¹⁾	373	335	149
TAJC107*016#NJ	C	100	16	85	10	125	16	8	1	1	332	298	133
TAJD107*016#NJ	D	100	16	85	10	125	16	6	0.6	1	500	450	200
TAJE107*016#NJ	E	100	16	85	10	125	16	6	0.9	1 ¹⁾	428	385	171
TAJF107M016#NJ	F	100	16	85	10	125	16	10	0.4	1	500	450	200
TAJY107*016#NJ	Y	100	16	85	10	125	16	8	0.9	1 ¹⁾	373	335	149
TAJD157*016#NJ	D	150	16	85	10	125	24	6	0.9	1	408	367	163
TAJE157*016#NJ	E	150	16	85	10	125	23	8	0.3	1 ¹⁾	742	667	297
TAJV157*016#NJ	V	150	16	85	10	125	24	8	0.5	1 ¹⁾	707	636	283
TAJY157M016#NJ	Y	150	16	85	10	125	24	15	0.3	1 ¹⁾	645	581	258
TAJE227*016#NJ	E	220	16	85	10	125	35.2	10	0.5	1 ¹⁾	574	517	230
TAJV227*016#NJ	V	220	16	85	10	125	35.2	8	0.9	1 ¹⁾	527	474	211
TAJE337M016#NJ	E	330	16	85	10	125	52.8	30	0.4	1 ¹⁾	642	578	257
20 Volt @ 85°C													
TAJR104*020#NJ	R	0.1	20	85	13	125	0.5	4	25	1	47	42	19
TAJS104*020#NJ	S	0.1	20	85	13	125	0.5	4	25	1	51	46	20
TAJR154*020#NJ	R	0.15	20	85	13	125	0.5	4	25	1	47	42	19
TAJS154*020#NJ	S	0.15	20	85	13	125	0.5	4	25	1	51	46	20
TAJR224*020#NJ	R	0.22	20	85	13	125	0.5	4	25	1	47	42	19
TAJS224*020#NJ	S	0.22	20	85	13	125	0.5	4	25	1	51	46	20
TAJR334*020#NJ	R	0.33	20	85	13	125	0.5	4	25	1	47	42	19
TAJS334*020#NJ	S	0.33	20	85	13	125	0.5	4	25	1	51	46	20
TAJR474*020#NJ	R	0.47	20	85	13	125	0.5	4	25	1	47	42	19
TAJS474*020#NJ	S	0.47	20	85	13	125	0.5	4	25	1	51	46	20
TAJR684*020#NJ	R	0.68	20	85	13	125	0.5	4	20	1	52	47	21
TAJS684*020#NJ	S	0.68	20	85	13	125	0.5	4	25	1	51	46	20
TAJT684*020#NJ	T	0.68	20	85	13	125	0.5	4	15	1	73	66	29
TAJA105*020#NJ	A	1	20	85	13	125	0.5	4	9	1	91	82	37
TAJR105*020#NJ	R	1	20	85	13	125	0.5	4	20	1	52	47	21
TAJS105*020#NJ	S	1	20	85	13	125	0.5	4	12	1	74	66	29
TAJT105*020#NJ	T	1	20	85	13	125	0.5	4	9	1	94	85	38
TAJA155*020#NJ	A	1.5	20	85	13	125	0.5	6	6.5	1	107	97	43
TAJP155*020#NJ	P	1.5	20	85	13	125	0.5	6	9.6	1	79	71	32
TAJR155*020#NJ	R	1.5	20	85	13	125	0.5	6	9.6	1	76	68	30
TAJS155*020#NJ	S	1.5	20	85	13	125	0.5	6	5.4	1	110	99	44
TAJT155*020#NJ	T	1.5	20	85	13	125	0.5	6	6.5	1	111	100	44
TAJA225*020#NJ	A	2.2	20	85	13	125	0.5	6	5.3	1	119	107	48
TAJB225*020#NJ	B	2.2	20	85	13	125	0.5	6	3.5	1	156	140	62
TAJP225*020#NJ	P	2.2	20	85	13	125	0.5	6	8.3	1	85	77	34
TAJR225*020#NJ	R	2.2	20	85	13	125	0.5	6	6	1	96	86	38
TAJS225*020#NJ	S	2.2	20	85	13	125	0.5	6	4.5	1	120	108	48
TAJT225*020#NJ	T	2.2	20	85	13	125	0.5	6	6	1	115	104	46
TAJA335*020#NJ	A	3.3	20	85	13	125	0.7	6	4.5	1	129	116	52
TAJB335*020#NJ	B	3.3	20	85	13	125	0.7	6	3	1	168	151	67
TAJT335*020#NJ	T	3.3	20	85	13	125	0.7	6	3	1	163	147	65
TAJA475*020#NJ	A	4.7	20	85	13	125	0.9	6	4	1	137	123	55
TAJB475*020#NJ	B	4.7	20	85	13	125	0.9	6	3	1	168	151	67
TAJT475*020#NJ	T	4.7	20	85	13	125	0.9	6	3.1	1	161	145	64
TAJA685*020#NJ	A	6.8	20	85	13	125	1.4	6	2.4	1	177	159	71

RATINGS & PART NUMBER REFERENCE

AVX Part No.	Case Size	Capacitance (µF)	Rated Voltage (V)	Rated Temperature (°C)	Category Voltage (V)	Category Temperature (°C)	DCL Max. (µA)	DF Max. (%)	ESR Max. @ 100kHz (Ω)	MSL	100kHz RMS Current (mA)		
											25°C	85°C	125°C
TAJB685*020#NJ	B	6.8	20	85	13	125	1.4	6	2.5	1	184	166	74
TAJC685*020#NJ	C	6.8	20	85	13	125	1.4	6	2	1	235	211	94
TAJT685*020#NJ	T	6.8	20	85	13	125	1.4	6	2.6	1	175	158	70
TAJB106*020#NJ	B	10	20	85	13	125	2	6	2.1	1	201	181	80
TAJC106*020#NJ	C	10	20	85	13	125	2	6	1.2	1	303	272	121
TAJW106*020#NJ	W	10	20	85	13	125	2	6	1.9	1	218	196	87
TAJB156*020#NJ	B	15	20	85	13	125	3	6	2	1	206	186	82
TAJC156*020#NJ	C	15	20	85	13	125	3	6	1.7	1	254	229	102
TAJW156*020#NJ	W	15	20	85	13	125	3	6	1.7	1	230	207	92
TAJB226*020#NJ	B	22	20	85	13	125	4.4	6	1.8	1	217	196	87
TAJC226*020#NJ	C	22	20	85	13	125	4.4	6	1.6	1	262	236	105
TAJD226*020#NJ	D	22	20	85	13	125	4.4	6	0.9	1	408	367	163
TAJW226*020#NJ	W	22	20	85	13	125	4.4	6	1.6	1	237	213	95
TAJY226*020#NJ	Y	22	20	85	13	125	4.4	6	0.9	1 ¹⁾	373	335	149
TAJC336*020#NJ	C	33	20	85	13	125	6.6	6	1.5	1	271	244	108
TAJD336*020#NJ	D	33	20	85	13	125	6.6	6	0.9	1	408	367	163
TAJX336*020#NJ	X	33	20	85	13	125	6.6	6	0.5	1 ¹⁾	447	402	179
TAJY336*020#NJ	Y	33	20	85	13	125	6.6	6	0.6	1 ¹⁾	456	411	183
TAJC476*020#NJ	C	47	20	85	13	125	9.4	6	0.5	1	469	422	188
TAJD476*020#NJ	D	47	20	85	13	125	9.4	6	0.9	1	408	367	163
TAJE476*020#NJ	E	47	20	85	13	125	9.4	6	0.9	1 ¹⁾	428	385	171
TAJX476*020#NJ	X	47	20	85	13	125	9.4	6	0.4	1 ¹⁾	500	450	200
TAJY476*020#NJ	Y	47	20	85	13	125	9.4	6	0.9	1 ¹⁾	373	335	149
TAJC686M020#NJ	C	68	20	85	13	125	13.6	8	0.5	1	469	422	188
TAJD686*020#NJ	D	68	20	85	13	125	13.6	6	0.4	1	612	551	245
TAJE686*020#NJ	E	68	20	85	13	125	13.6	6	0.9	1 ¹⁾	428	385	171
TAJY686*020#NJ	Y	68	20	85	13	125	13.6	6	0.9	1 ¹⁾	373	335	149
TAJD107*020#NJ	D	100	20	85	13	125	20	6	0.5	1	548	493	219
TAJE107*020#NJ	E	100	20	85	13	125	20	6	0.4	1 ¹⁾	642	578	257
TAJV107*020#NJ	V	100	20	85	13	125	20	8	0.9	1 ¹⁾	527	474	211
TAJE157*020#NJ	E	150	20	85	13	125	30	8	0.3	1 ¹⁾	742	667	297
TAJV157*020#NJ	V	150	20	85	13	125	30	8	0.3	1 ¹⁾	913	822	365
25 Volt @ 85°C													
TAJR154*025#NJ	R	0.15	25	85	17	125	0.5	4	24	1	48	43	19
TAJR224*025#NJ	R	0.15	25	85	17	125	0.5	4	21	1	51	46	20
TAJR334*025#NJ	R	0.15	25	85	17	125	0.5	4	17	1	57	51	23
TAJA474*025#NJ	A	0.47	25	85	17	125	0.5	4	14	1	73	66	29
TAJR474*025#NJ	R	0.47	25	85	17	125	0.5	4	15	1	61	54	24
TAJS474*025#NJ	S	0.47	25	85	17	125	0.5	4	9	1	85	76	34
TAJA684*025#NJ	A	0.68	25	85	17	125	0.5	4	10	1	87	78	35
TAJR684*025#NJ	R	0.68	25	85	17	125	0.5	4	13	1	65	59	26
TAJS684*025#NJ	S	0.68	25	85	17	125	0.5	4	8	1	90	81	36
TAJA105*025#NJ	A	1	25	85	17	125	0.5	4	8	1	97	87	39
TAJP105*025#NJ	P	1	25	85	17	125	0.5	4	11	1	74	66	30
TAJR105*025#NJ	R	1	25	85	17	125	0.5	4	8	1	83	75	33
TAJS105*025#NJ	S	1	25	85	17	125	0.5	4	8	1	90	81	36
TAJA155*025#NJ	A	1.5	25	85	17	125	0.5	6	7.5	1	100	90	40
TAJB155*025#NJ	B	1.5	25	85	17	125	0.5	6	5	1	130	117	52
TAJP155*025#NJ	P	1.5	25	85	17	125	0.5	6	9.6	1	79	71	32
TAJS155*025#NJ	S	1.5	25	85	17	125	0.5	6	5.4	1	110	99	44
TAJT155*025#NJ	T	1.5	25	85	17	125	0.5	6	5	1	126	114	51
TAJA225*025#NJ	A	2.2	25	85	17	125	0.6	6	7	1	104	93	41
TAJB225*025#NJ	B	2.2	25	85	17	125	0.6	6	4.5	1	137	124	55
TAJT225*025#NJ	T	2.2	25	85	17	125	0.6	6	4.5	1	133	120	53
TAJA335*025#NJ	A	3.3	25	85	17	125	0.8	6	3.7	1	142	128	57
TAJB335*025#NJ	B	3.3	25	85	17	125	0.8	6	3.5	1	156	140	62
TAJT335*025#NJ	T	3.3	25	85	17	125	0.8	6	3.5	1	151	136	60
TAJW335*025#NJ	W	3.3	25	85	17	125	0.8	6	1.6	1	237	213	95
TAJA475*025#NJ	A	4.7	25	85	17	125	1.2	6	3.1	1	156	140	62
TAJB475*025#NJ	B	4.7	25	85	17	125	1.2	6	1.5	1	238	214	95
TAJT475*025#NJ	T	4.7	25	85	17	125	1.2	6	3.1	1	161	145	64
TAJW475*025#NJ	W	4.7	25	85	17	125	1.2	6	1.2	1	274	246	110
TAJB685*025#NJ	B	6.8	25	85	17	125	1.7	6	2.8	1	174	157	70
TAJC685*025#NJ	C	6.8	25	85	17	125	1.7	6	2	1	235	211	94
TAJW685*025#NJ	W	6.8	25	85	17	125	1.7	6	2	1	212	191	85
TAJB106*025#NJ	B	10	25	85	17	125	2.5	6	2.5	1	184	166	74
TAJC106*025#NJ	C	10	25	85	17	125	2.5	6	1.8	1	247	222	99
TAJD106*025#NJ	D	10	25	85	17	125	2.5	6	1.2	1	354	318	141
TAJW106*025#NJ	W	10	25	85	17	125	2.5	6	1.8	1	224	201	89
TAJC156*025#NJ	C	15	25	85	17	125	3.8	6	1.6	1	262	236	105
TAJD156*025#NJ	D	15	25	85	17	125	3.8	6	1	1	387	349	155

RATINGS & PART NUMBER REFERENCE

AVX Part No.	Case Size	Capacitance (µF)	Rated Voltage (V)	Rated Temperature (°C)	Category Voltage (V)	Category Temperature (°C)	DCL Max. (µA)	DF Max (%)	ESR Max. @ 100kHz (Ω)	MSL	100kHz RMS Current (mA)		
											25°C	85°C	125°C
TAJY156*025#NJ	Y	15	25	85	17	125	3.8	6	1	1 ¹⁾	354	318	141
TAJC226*025#NJ	C	22	25	85	17	125	5.5	6	1.4	1	280	252	112
TAJD226*025#NJ	D	22	25	85	17	125	5.5	6	0.9	1	408	367	163
TAJF226*025#NJ	F	22	25	85	17	125	5.5	6	1	1	316	285	126
TAJY226*025#NJ	Y	22	25	85	17	125	5.5	6	0.8	1 ¹⁾	395	356	158
TAJC336*025#NJ	C	33	25	85	17	125	8.3	6	0.9	1	350	315	140
TAJD336*025#NJ	D	33	25	85	17	125	8.3	6	0.9	1	408	367	163
TAJE336*025#NJ	E	33	25	85	17	125	8.3	6	0.9	1 ¹⁾	428	385	171
TAJY336*025#NJ	Y	33	25	85	17	125	8.3	6	0.5	1 ¹⁾	500	450	200
TAJD476*025#NJ	D	47	25	85	17	125	11.8	6	0.9	1	408	367	163
TAJE476*025#NJ	E	47	25	85	17	125	11.8	6	0.9	1 ¹⁾	428	385	171
TAJY476*025#NJ	Y	47	25	85	17	125	11.8	6	0.9	1 ¹⁾	373	335	149
TAJD686*025#NJ	D	68	25	85	17	125	17	6	0.9	1	408	367	163
TAJE686*025#NJ	E	68	25	85	17	125	17	6	0.9	1 ¹⁾	428	385	171
TAJV686*025#NJ	V	68	25	85	17	125	17	6	0.9	1 ¹⁾	527	474	211
TAJE107*025#NJ	E	100	25	85	17	125	25	10	0.3	1 ¹⁾	742	667	297
TAJV107*025#NJ	V	100	25	85	17	125	25	8	0.4	1 ¹⁾	791	712	316
TAJV157M025#NJ	V	150	25	85	17	125	37.5	10	0.4	1 ¹⁾	791	712	316
35 Volt @ 85°C													
TAJA104*035#NJ	A	0.1	35	85	23	125	0.5	4	24	1	56	50	22
TAJR104*035#NJ	R	0.1	35	85	23	125	0.5	4	29	1	44	39	17
TAJS104*035#NJ	S	0.1	35	85	23	125	0.5	4	24	1	52	47	21
TAJA154*035#NJ	A	0.15	35	85	23	125	0.5	4	21	1	60	54	24
TAJR154*035#NJ	R	0.15	35	85	23	125	0.5	4	24	1	48	43	19
TAJS154*035#NJ	S	0.15	35	85	23	125	0.5	4	21	1	56	50	22
TAJA224*035#NJ	A	0.22	35	85	23	125	0.5	4	18	1	65	58	26
TAJR224*035#NJ	R	0.22	35	85	23	125	0.5	4	21	1	51	46	20
TAJS224*035#NJ	S	0.22	35	85	23	125	0.5	4	18	1	60	54	24
TAJA334*035#NJ	A	0.33	35	85	23	125	0.5	4	15	1	71	64	28
TAJR334*035#NJ	R	0.33	35	85	23	125	0.5	4	17	1	57	51	23
TAJS334*035#NJ	S	0.33	35	85	23	125	0.5	4	15	1	66	59	26
TAJA474*035#NJ	A	0.47	35	85	23	125	0.5	4	12	1	79	71	32
TAJB474*035#NJ	B	0.47	35	85	23	125	0.5	4	10	1	92	83	37
TAJR474*035#NJ	R	0.47	35	85	23	125	0.5	4	15	1	61	54	24
TAJS474*035#NJ	S	0.47	35	85	23	125	0.5	4	12	1	74	66	29
TAJT474*035#NJ	T	0.47	35	85	23	125	0.5	4	10	1	89	80	36
TAJA684*035#NJ	A	0.68	35	85	23	125	0.5	4	8	1	97	87	39
TAJB684*035#NJ	B	0.68	35	85	23	125	0.5	4	8	1	103	93	41
TAJP684*035#NJ	P	0.68	35	85	23	125	0.5	4	13	1	68	61	27
TAJS684*035#NJ	S	0.68	35	85	23	125	0.5	4	8	1	90	81	36
TAJT684*035#NJ	T	0.68	35	85	23	125	0.5	4	8	1	100	90	40
TAJA105*035#NJ	A	1	35	85	23	125	0.5	4	7.5	1	100	90	40
TAJB105*035#NJ	B	1	35	85	23	125	0.5	4	6.5	1	114	103	46
TAJP105*035#NJ	P	1	35	85	23	125	0.5	4	11	1	74	66	30
TAJS105*035#NJ	S	1	35	85	23	125	0.5	4	7.5	1	93	84	37
TAJT105*035#NJ	T	1	35	85	23	125	5	4	6.5	1	111	100	44
TAJA155*035#NJ	A	1.5	35	85	23	125	0.5	6	7.5	1	100	90	40
TAJB155*035#NJ	B	1.5	35	85	23	125	0.5	6	5.2	1	128	115	51
TAJC155*035#NJ	C	1.5	35	85	23	125	0.5	6	4.5	1	156	141	63
TAJT155*035#NJ	T	1.5	35	85	23	125	0.5	6	5.2	1	124	112	50
TAJA225*035#NJ	A	2.2	35	85	23	125	0.8	6	4.5	1	129	116	52
TAJB225*035#NJ	B	2.2	35	85	23	125	0.8	6	4.2	1	142	128	57
TAJC225*035#NJ	C	2.2	35	85	23	125	0.8	6	3.5	1	177	160	71
TAJT225*035#NJ	T	2.2	35	85	23	125	0.8	6	4.2	1	138	124	55
TAJB335*035#NJ	B	3.3	35	85	23	125	1.2	6	3.5	1	156	140	62
TAJC335*035#NJ	C	3.3	35	85	23	125	1.2	6	2.5	1	210	189	84
TAJW335*035#NJ	W	3.3	35	85	23	125	1.2	6	1.6	1	237	213	95
TAJB475*035#NJ	B	4.7	35	85	23	125	1.6	6	3.1	1	166	149	66
TAJC475*035#NJ	C	4.7	35	85	23	125	1.6	6	2.2	1	224	201	89
TAJD475*035#NJ	D	4.7	35	85	23	125	1.6	6	1.5	1	316	285	126
TAJW475*035#NJ	W	4.7	35	85	23	125	1.6	6	2.2	1	202	182	81
TAJC685*035#NJ	C	6.8	35	85	23	125	2.4	6	1.8	1	247	222	99
TAJD685*035#NJ	D	6.8	35	85	23	125	2.4	6	1.3	1	340	306	136
TAJY685*035#NJ	Y	6.8	35	85	23	125	2.3	6	0.9	1 ¹⁾	373	335	149
TAJC106*035#NJ	C	10	35	85	23	125	3.5	6	1.6	1	262	236	105
TAJD106*035#NJ	D	10	35	85	23	125	3.5	6	1	1	387	349	155
TAJE106*035#NJ	E	10	35	85	23	125	3.5	6	0.9	1 ¹⁾	428	385	171
TAJX106*035#NJ	X	10	35	85	23	125	3.5	6	0.7	1 ¹⁾	378	340	151
TAJY106*035#NJ	Y	10	35	85	23	125	3.5	6	1	1 ¹⁾	354	318	141
TAJC156*035#NJ	C	15	35	85	23	125	5.3	6	1.4	1	280	252	112
TAJD156*035#NJ	D	15	35	85	23	125	5.3	6	0.9	1	408	367	163

Standard and Low Profile Tantalum Capacitors

RATINGS & PART NUMBER REFERENCE

AVX Part No.	Case Size	Capacitance (µF)	Rated Voltage (V)	Rated Temperature (°C)	Category Voltage (V)	Category Temperature (°C)	DCL Max. (µA)	DF Max. (%)	ESR Max. @ 100kHz (Ω)	MSL	100kHz RMS Current (mA)		
											25°C	85°C	125°C
TAJY156*035#NJ	Y	15	35	85	23	125	5.3	6	0.6	1 ¹⁾	456	411	183
TAJD226*035#NJ	D	22	35	85	23	125	7.7	6	0.9	1	408	367	163
TAJE226*035#NJ	E	22	35	85	23	125	7.7	6	0.5	1 ¹⁾	574	517	230
TAJY226*035#NJ	Y	22	35	85	23	125	7.7	6	0.5	1 ¹⁾	500	450	200
TAJD336*035#NJ	D	33	35	85	23	125	11.6	6	0.9	1	408	367	163
TAJE336*035#NJ	E	33	35	85	23	125	11.6	6	0.9	1 ¹⁾	428	385	171
TAJV336*035#NJ	V	33	35	85	23	125	11.6	6	0.5	1 ¹⁾	707	636	283
TAJE476*035#NJ	E	47	35	85	23	125	16.5	6	0.9	1 ¹⁾	428	385	171
TAJV476*035#NJ	V	47	35	85	23	125	16.5	6	0.4	1 ¹⁾	791	712	316
TAJV686*035#NJ	V	68	35	85	23	125	23.8	6	0.5	1 ¹⁾	707	363	283
50 Volt @ 85°C													
TAJA104*050#NJ	A	0.1	50	85	33	125	0.5	4	22	1	58	53	23
TAJS104*050#NJ	S	0.1	50	85	33	125	0.5	4	19	1	58	53	23
TAJA154*050#NJ	A	0.15	50	85	33	125	0.5	4	15	1	71	64	28
TAJB154*050#NJ	B	0.15	50	85	33	125	0.5	4	17	1	71	64	28
TAJS154*050#NJ	S	0.15	50	85	33	125	0.5	4	16	1	64	57	25
TAJA224*050#NJ	A	0.22	50	85	33	125	0.5	4	18	1	65	58	26
TAJB224*050#NJ	B	0.22	50	85	33	125	0.5	4	14	1	78	70	31
TAJP224*050#NJ	P	0.22	50	85	33	125	0.5	4	17	1	59	53	24
TAJR224*050#NJ	R	0.22	50	85	33	125	0.5	4	17	1	57	51	23
TAJS224*050#NJ	S	0.22	50	85	33	125	0.5	4	13	1	71	64	28
TAJA334*050#NJ	A	0.33	50	85	33	125	0.5	4	17	1	66	60	27
TAJB334*050#NJ	B	0.33	50	85	33	125	0.5	4	12	1	84	76	34
TAJP334*050#NJ	P	0.33	50	85	33	125	0.5	4	17	1	59	53	24
TAJR334M050#NJ	R	0.33	50	85	33	125	0.5	4	17	1	57	51	23
TAJS334*050#NJ	S	0.33	50	85	33	125	0.5	4	11	1	77	69	31
TAJT334*050#NJ	T	0.33	50	85	33	125	0.5	4	11	1	85	77	34
TAJA474*050#NJ	A	0.47	50	85	33	125	0.5	4	9.5	1	89	80	36
TAJB474*050#NJ	B	0.47	50	85	33	125	0.7	4	9.5	1	95	85	38
TAJC474*050#NJ	C	0.47	50	85	33	125	0.5	4	8	1	117	106	47
TAJS474*050#NJ	S	0.47	50	85	33	125	0.5	4	9.5	1	83	74	33
TAJT474*050#NJ	T	0.47	50	85	33	125	0.5	4	9.5	1	92	83	37
TAJA684*050#NJ	A	0.68	50	85	33	125	0.5	4	7.9	1	97	88	39
TAJB684*050#NJ	B	0.68	50	85	33	125	0.5	4	8	1	103	93	41
TAJC684*050#NJ	C	0.68	50	85	33	125	0.5	4	7	1	125	113	50
TAJA105*050#NJ	A	1	50	85	33	125	0.5	4	6.6	1	107	96	43
TAJB105*050#NJ	B	1	50	85	33	125	0.5	6	7	1	110	99	44
TAJC105*050#NJ	C	1	50	85	33	125	0.5	4	5.5	1	141	127	57
TAJW105*050#NJ	W	1	50	85	33	125	0.5	6	4.4	1	143	129	57
TAJB155*050#NJ	B	1.5	50	85	33	125	0.8	8	5.4	1	125	113	50
TAJC155*050#NJ	C	1.5	50	85	33	125	0.8	6	4.5	1	156	141	63
TAJD155*050#NJ	D	1.5	50	85	33	125	0.8	6	4	1	194	174	77
TAJW155*050#NJ	W	1.5	50	85	33	125	0.8	6	3.1	1	170	153	68
TAJB225*050#NJ	B	2.2	50	85	33	125	1.1	8	4.5	1	137	124	55
TAJC225*050#NJ	C	2.2	50	85	33	125	1.1	8	2.5	1	210	189	84
TAJD225*050#NJ	D	2.2	50	85	33	125	1.1	6	2.5	1	245	220	98
TAJW225*050#NJ	W	2.2	50	85	33	125	1.1	8	2.5	1	190	171	76
TAJC335*050#NJ	C	3.3	50	85	33	125	1.6	6	2.5	1	210	189	84
TAJD335*050#NJ	D	3.3	50	85	33	125	1.7	6	2	1	274	246	110
TAJY335*050#NJ	Y	3.3	50	85	33	125	1.7	4	1.5	1 ¹⁾	289	260	115
TAJC475*050#NJ	C	4.7	50	85	33	125	0.5	4	1.4	1	280	252	112
TAJD475*050#NJ	D	4.7	50	85	33	125	2.4	6	1.4	1	327	295	131
TAJX475*050#NJV	X	4.7	50	85	33	125	2.4	6	1.0	3	316	285	126
TAJY475*050#NJ	Y	4.7	50	85	33	125	2.4	6	1.2	1 ¹⁾	323	290	129
TAJC685*050#NJ	C	6.8	50	85	33	125	3.4	6	1	1	332	298	133
TAJD685*050#NJ	D	6.8	50	85	33	125	3.4	6	1	1	387	349	155
TAJY685*050#NJ	Y	6.8	50	85	33	125	3.4	6	0.9	1 ¹⁾	373	335	149
TAJD106*050#NJ	D	10	50	85	33	125	5	6	0.8	1	433	390	173
TAJE106*050#NJ	E	10	50	85	33	125	5	6	1	1 ¹⁾	406	366	162
TAJV106*050#NJ	V	10	50	85	33	125	5	6	0.65	1 ¹⁾	620	558	248
TAJD156*050#NJ	D	15	50	85	33	125	7.5	6	0.6	1	500	450	200
TAJE156*050#NJ	E	15	50	85	33	125	7.5	6	0.6	1 ¹⁾	524	472	210
TAJV156*050#NJ	V	15	50	85	33	125	7.5	6	0.6	1 ¹⁾	645	581	258
TAJV226*050#NJ	V	22	50	85	33	125	11	8	0.6	1 ¹⁾	645	581	258

1¹⁾ - Dry pack option (see How to order) is recommended for reduction of stress during soldering. Dry pack parts should be treated as MSL 3.

Moisture Sensitivity Level (MSL) is defined according to J-STD-020.

All technical data relates to an ambient temperature of +25°C. Capacitance and DF are measured at 120Hz, 0.5V RMS with a maximum DC bias of 2.2 volts. DCL is measured at rated voltage after 5 minutes.

For typical weight and composition see page 222.

NOTE: AVX reserves the right to supply a higher voltage ratings or tighter tolerance part in the same case size, to the same reliability standards.

QUALIFICATION TABLE

TEST	TAJ series (Temperature range -55°C to +125°C)										
	Condition			Characteristics							
Endurance	Apply rated voltage (UR) at 85±2°C and / or category voltage (Uc) at 125±2°C for 2000 +48/-0 hours through a circuit impedance of ≤0.1Ω/V. Stabilize at room temperature for 1-2 hours before measuring.			Visual examination	no visible damage						
				DCL	1.25 x initial limit						
				ΔC/C	within ±10% of initial value						
				DF	initial limit						
Humidity	Store at 65±2°C and 95±2% relative humidity for 500 +48/-0 hours, with no applied voltage. Stabilize at room temperature and humidity for 1-2 hours before measuring.			Visual examination	no visible damage						
				DCL	initial limit						
				ΔC/C	within ±10% of initial value						
				DF	1.2 x initial limit						
Temperature Stability	Step	Temperature°C	Duration(min)		+20°C	-55°C	+20°C	+85°C	+125°C	+20°C	
	1	+20±2	15	DCL	IL*	n/a	IL*	10 x IL*	12.5 x IL*	IL*	
	2	-55+0/-3	15		ΔC/C	n/a	+0/-10%	±5%	+10/-0%	+12/-0%	±5%
	3	+20±2	15	DF		IL*	1.5 x IL*	IL*	1.5 x IL*	2 x IL*	IL*
	4	+85+3/-0	15								
	5	+125+3/-0	15								
6	+20±2	15									
Surge Voltage	Apply 1.3x category voltage (Uc) at 125 +3/-0°C for 1,000 cycles of duration 6 mins. (30 secs. charge, 5 min. 30 sec. discharge) through a charge / discharge resistance of 1000±100Ω			Visual examination	no visible damage						
				DCL	initial limit						
				ΔC/C	within ±5% of initial value						
				DF	initial limit						

*Initial Limit

AVX SOLID ELECTROLYTIC CAPACITOR ROADMAP

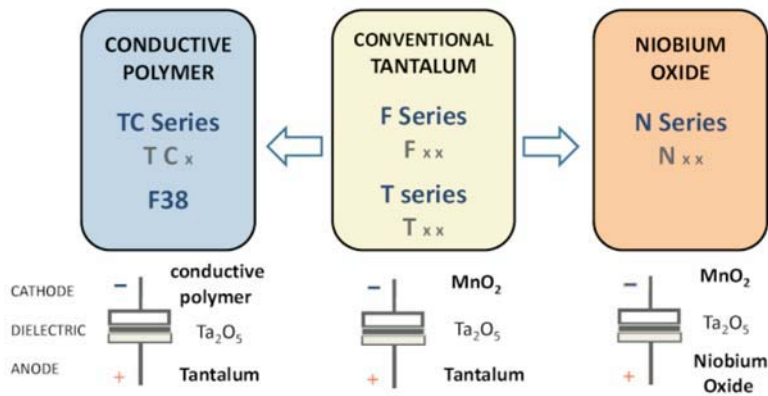

FIVE CAPACITOR CONSTRUCTION STYLES

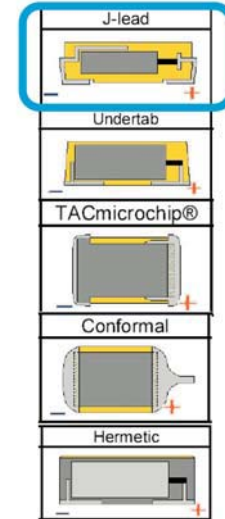

SERIES LINE UP: CONVENTIONAL SMD MnO₂

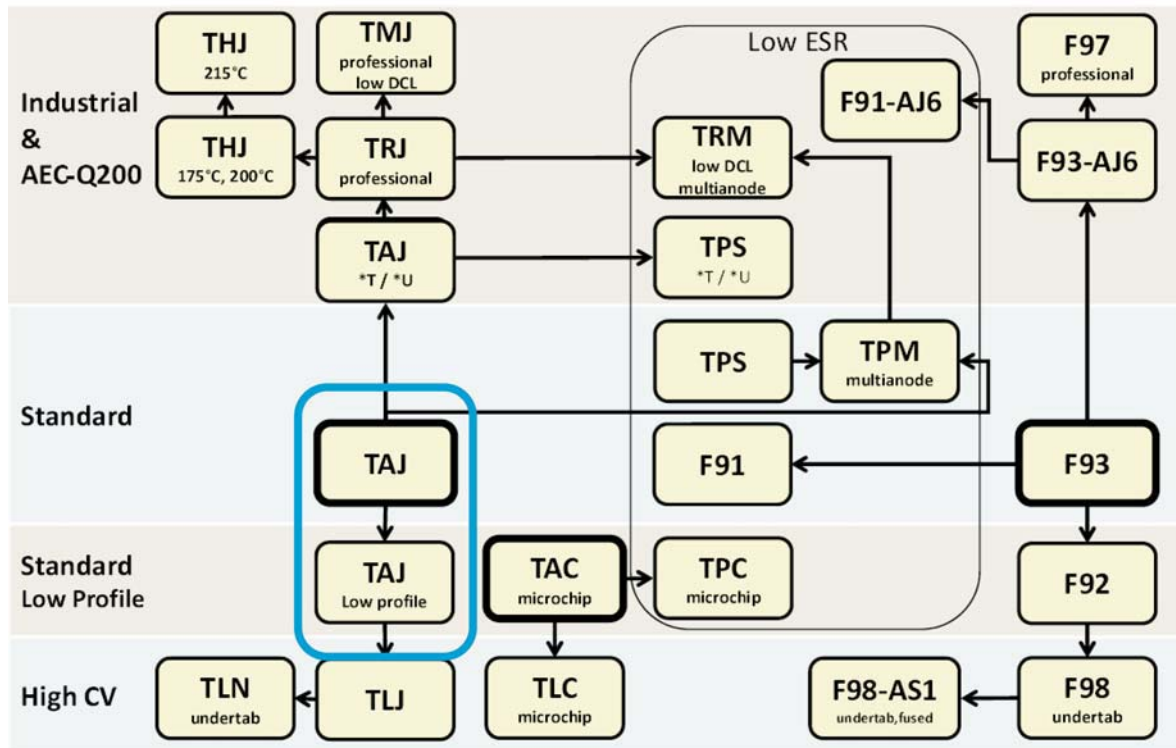

TAJ Automotive Range



Standard Tantalum - Automotive Product Range



FEATURES

- General purpose SMT chip tantalum series
- 6 case sizes available
- CV range: 0.22-680µF / 6.3-50V



APPLICATIONS

- Audio Systems
- GPS
- Seat Controls
- Dashboard

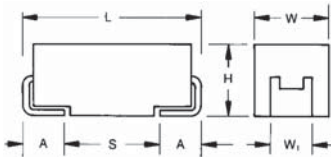

CASE DIMENSIONS: millimeters (inches)

Code	EIA Code	EIA Metric	L±0.20 (0.008)	W+0.20 (0.008) -0.10 (0.004)	H+0.20 (0.008) -0.10 (0.004)	W ₁ ±0.20 (0.008)	A+0.30 (0.012) -0.20 (0.008)	S Min.
A	1206	3216-18	3.20 (0.126)	1.60 (0.063)	1.60 (0.063)	1.20 (0.047)	0.80 (0.031)	1.10 (0.043)
B	1210	3528-21	3.50 (0.138)	2.80 (0.110)	1.90 (0.075)	2.20 (0.087)	0.80 (0.031)	1.40 (0.055)
C	2312	6032-28	6.00 (0.236)	3.20 (0.126)	2.60 (0.102)	2.20 (0.087)	1.30 (0.051)	2.90 (0.114)
D	2917	7343-31	7.30 (0.287)	4.30 (0.169)	2.90 (0.114)	2.40 (0.094)	1.30 (0.051)	4.40 (0.173)
E	2917	7343-43	7.30 (0.287)	4.30 (0.169)	4.10 (0.162)	2.40 (0.094)	1.30 (0.051)	4.40 (0.173)
Y	2917	7343-20	7.30 (0.287)	4.30 (0.169)	2.00 (0.079)	2.40 (0.094)	1.30 (0.051)	4.40 (0.173)

W₁ dimension applies to the termination width for A dimensional area only.

MARKING

A, B, C, D, E, Y CASE

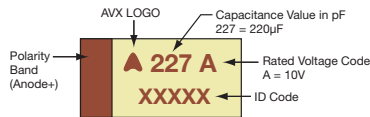

HOW TO ORDER

TAJ Type	C Case Size See table above	106 Capacitance Code pF code: 1st two digits represent significant figures, 3rd digit represents multiplier (number of zeros to follow)	M Tolerance K = ±10% M = ±20%	035 Rated DC Voltage 006 = 6.3Vdc 010 = 10Vdc 016 = 16Vdc 020 = 20Vdc 025 = 25Vdc 035 = 35Vdc 050 = 50Vdc	T Packaging T = Automotive Lead Free 7" Reel U = Automotive Lead Free 13" Reel	NJ Specification Suffix NJ = Std Suffix	V Dry Pack Option (D,E case sizes mandatory)
--------------------	--	--	---	--	--	--	---

TECHNICAL SPECIFICATIONS

Technical Data:	All technical data relate to an ambient temperature of +25°C							
Capacitance Range:	0.22 µF to 680 µF							
Capacitance Tolerance:	±10%; ±20%							
Rated Voltage (V _R)	≤ +85°C:	6.3	10	16	20	25	35	50
Category Voltage (V _C)	≤ +125°C:	4	7	10	13	17	23	33
Surge Voltage (V _S)	≤ +85°C:	8	13	20	26	32	46	65
Surge Voltage (V _S)	≤ +125°C:	5	8	13	16	20	28	40
Temperature Range:	-55°C to +125°C							
Environmental Classification:	55/125/56 (IEC 68-2)							
Reliability:	1% per 1000 hours at 85°C, V _R with 0.1Ω/V series impedance, 60% confidence level							
Termination Finished:	Sn Plating (standard), Gold and SnPb Plating upon request							
	Meets requirements of AEC-Q200							

TAJ Automotive Range



Standard Tantalum - Automotive Product Range

TAJ AUTOMOTIVE RANGE CAPACITANCE AND RATED VOLTAGE RANGE (LETTER DENOTES CASE SIZE)

Capacitance		Rated voltage DC (V _R) to 85°C						
µF	Code	6.3V (J)	10V (A)	16V (C)	20V (D)	25V (E)	35V (V)	50V (T)
0.10 0.15 0.22	104 154 224							A
0.33 0.47 0.68	334 474 684					A A	A A A	A A/B B
1.0 1.5 2.2	105 155 225		A	A	A A A/B	A A/B A/B	A/B A/B B/C	B/C C C/D
3.3 4.7 6.8	335 475 685	A	A/B A/B	A/B A/B A/B	A/B A/B B/C	A/B B/C B/C	B/C B/C/D C/D	C/D C/D D
10 15 22	106 156 226	A/B A A/B/C	A/B A/B/C A/B/C	A/B/C B/C B/C/D	B/C B/C C/D/Y	C/D C/D/Y C/D/Y	C/D/Y D/Y D/E	D/E E
33 47 68	336 476 686	A/B B/C B/C	B/C B/C/D C/D/Y	C/D/Y C/D/Y C/D/Y	C/D/Y D/Y D/E	D D/E	D/E	
100 150 220	107 157 227	C/D/Y C/D/Y D/Y	C/D/Y D/E/Y D/E	D/E E	E	E		
330 470 680	337 477 687	D/E D/E E	E					

Not recommended for new designs; higher voltage or smaller case size alternatives are available.

Released ratings

Note: Voltage ratings are minimum values. AVX reserves the right to supply higher voltage ratings in the same case size, to the same reliability standards.

TAJ Automotive Range



Standard Tantalum - Automotive Product Range

RATINGS & PART NUMBER REFERENCE

AVX Part No.	Case Size	Capacitance (µF)	Rated Voltage (V)	Rated Temperature (°C)	Category Voltage (V)	Category Temperature (°C)	DCL Max. (µA)	DF Max. (%)	ESR Max. @ 100kHz (Ω)	MSL	100kHz RMS Current (mA)		
											25°C	85°C	125°C
6.3 Volt @ 85°C													
TAJA335*006TNJ	A	3.3	6.3	85	4	125	0.5	6	7	1	104	93	41
TAJA106*006TNJ	A	10	6.3	85	4	125	0.6	6	4	1	137	123	55
TAJB106*006TNJ	B	10	6.3	85	4	125	0.5	6	3	1	168	151	67
TAJA156*006TNJ	A	15	6.3	85	4	125	0.9	6	3.5	1	146	132	59
TAJA226*006TNJ	A	22	6.3	85	4	125	1.4	6	3	1	158	142	63
TAJB226*006TNJ	B	22	6.3	85	4	125	1.4	6	2.5	1	184	166	74
TAJC226*006TNJ	C	22	6.3	85	4	125	1.4	6	2	1	235	211	94
TAJA336*006TNJ	A	33	6.3	85	4	125	2.1	8	2.2	1	185	166	74
TAJB336*006TNJ	B	33	6.3	85	4	125	2.1	6	2.2	1	197	177	79
TAJB476*006TNJ	B	47	6.3	85	4	125	3	6	2	1	206	186	82
TAJC476*006TNJ	C	47	6.3	85	4	125	3	6	1.6	1	262	236	105
TAJB686*006TNJ	B	68	6.3	85	4	125	4	8	0.9	1	307	277	123
TAJC686*006TNJ	C	68	6.3	85	4	125	4.3	6	1.5	1	271	244	108
TAJC107*006TNJ	C	100	6.3	85	4	125	6.3	6	0.9	1	350	315	140
TAJD107*006TNJV	D	100	6.3	85	4	125	6.3	6	0.9	3	408	367	163
TAJY107*006TNJV	Y	100	6.3	85	4	125	6.3	6	0.7	3	423	380	169
TAJC157*006TNJ	C	150	6.3	85	4	125	9.5	6	1.3	1	291	262	116
TAJD157*006TNJV	D	150	6.3	85	4	125	9.5	6	0.9	3	408	367	163
TAJY157*006TNJV	Y	150	6.3	85	4	125	9.5	6	0.4	3	559	503	224
TAJD227*006TNJV	D	220	6.3	85	4	125	13.9	8	0.4	3	612	551	245
TAJY227*006TNJV	Y	220	6.3	85	4	125	13.9	8	0.7	3	423	380	169
TAJD337*006TNJV	D	330	6.3	85	4	125	20.8	8	0.4	3	612	551	245
TAJE337*006TNJV	E	330	6.3	85	4	125	20.8	8	0.4	3	642	578	257
TAJD477*006TNJV	D	470	6.3	85	4	125	28	12	0.4	3	612	551	245
TAJE477*006TNJV	E	470	6.3	85	4	125	28	10	0.4	3	642	578	257
TAJE687*006TNJV	E	680	6.3	85	4	125	42.8	10	0.5	3	574	517	230
10 Volt @ 85°C													
TAJA225*010TNJ	A	2.2	10	85	7	125	0.5	6	7	1	104	93	41
TAJA475*010TNJ	A	4.7	10	85	7	125	0.5	6	5	1	122	110	49
TAJB475*010TNJ	B	4.7	10	85	7	125	0.5	6	4	1	146	131	58
TAJA685*010TNJ	A	6.8	10	85	7	125	0.7	6	4	1	137	123	55
TAJB685*010TNJ	B	6.8	10	85	7	125	0.7	6	3	1	168	151	67
TAJA106*010TNJ	A	10	10	85	7	125	1	6	3	1	158	142	63
TAJB106*010TNJ	B	10	10	85	7	125	1	6	2.1	1	201	181	80
TAJA156*010TNJ	A	15	10	85	7	125	1.5	6	3.2	1	153	138	61
TAJB156*010TNJ	B	15	10	85	7	125	1.5	6	2.8	1	174	157	70
TAJC156*010TNJ	C	15	10	85	7	125	1.5	6	2	1	235	211	94
TAJA226*010TNJ	A	22	10	85	7	125	2.2	8	3	1	158	142	63
TAJB226*010TNJ	B	22	10	85	7	125	2.2	6	2.4	1	188	169	75
TAJC226*010TNJ	C	22	10	85	7	125	2.2	6	1.8	1	247	222	99
TAJB336*010TNJ	B	33	10	85	7	125	3.3	6	1.8	1	217	196	87
TAJC336*010TNJ	C	33	10	85	7	125	3.3	6	1.6	1	262	236	105
TAJB476*010TNJ	B	47	10	85	7	125	4.7	8	1	1	292	262	117
TAJC476*010TNJ	C	47	10	85	7	125	4.7	6	1.2	1	303	272	121
TAJD476*010TNJV	D	47	10	85	7	125	4.7	6	0.4	3	612	551	245
TAJC686*010TNJ	C	68	10	85	7	125	6.8	6	1.3	1	291	262	116
TAJD686*010TNJV	D	68	10	85	7	125	6.8	6	0.9	3	408	367	163
TAJY686*010TNJV	Y	68	10	85	7	125	6.8	6	0.9	3	373	335	149
TAJC107*010TNJ	C	100	10	85	7	125	10	8	1.2	1	303	272	121
TAJD107*010TNJV	D	100	10	85	7	125	10	6	0.9	3	408	367	163
TAJY107*010TNJV	Y	100	10	85	7	125	10	6	0.9	3	373	335	149
TAJD157*010TNJV	D	150	10	85	7	125	15	8	0.9	3	408	367	163
TAJE157*010TNJV	E	150	10	85	7	125	15	8	0.9	3	428	385	171
TAJY157*010TNJV	Y	150	10	85	7	125	15	6	1.2	3	323	290	129
TAJD227*010TNJV	D	220	10	85	7	125	22	8	0.5	3	548	493	219
TAJE227*010TNJV	E	220	10	85	7	125	22	8	0.5	3	574	517	230
TAJE337*010TNJV	E	330	10	85	7	125	33	8	0.9	3	428	385	171
16 Volt @ 85°C													
TAJA105*016TNJ	A	1	16	85	10	125	0.5	4	11	1	83	74	33
TAJA225*016TNJ	A	2.2	16	85	10	125	0.5	6	6.5	1	107	97	43
TAJA335*016TNJ	A	3.3	16	85	10	125	0.5	6	5	1	122	110	49
TAJB335*016TNJ	B	3.3	16	85	10	125	0.5	6	4.5	1	137	124	55
TAJA475*016TNJ	A	4.7	16	85	10	125	0.8	6	4	1	137	123	55
TAJB475*016TNJ	B	4.7	16	85	10	125	0.8	6	3.5	1	156	140	62
TAJA685*016TNJ	A	6.8	16	85	10	125	1.1	6	3.5	1	146	132	59
TAJB685*016TNJ	B	6.8	16	85	10	125	1.1	6	2.5	1	184	166	74
TAJA106*016TNJ	A	10	16	85	10	125	1.6	6	3	1	158	142	63
TAJB106*016TNJ	B	10	16	85	10	125	1.6	6	2.5	1	184	166	74
TAJC106*016TNJ	C	10	16	85	10	125	1.6	6	2	1	235	211	94

TAJ Automotive Range



Standard Tantalum - Automotive Product Range

RATINGS & PART NUMBER REFERENCE

AVX Part No.	Case Size	Capacitance (µF)	Rated Voltage (V)	Rated Temperature (°C)	Category Voltage (V)	Category Temperature (°C)	DCL Max. (µA)	DF Max. (%)	ESR Max. @ 100kHz (Ω)	MSL	100kHz RMS Current (mA)		
											25°C	85°C	125°C
TAJB156*016TNJ	B	15	16	85	10	125	2.4	6	2.5	1	184	166	74
TAJC156*016TNJ	C	15	16	85	10	125	2.4	6	1.8	1	247	222	99
TAJB226*016TNJ	B	22	16	85	10	125	3.5	6	2.3	1	192	173	77
TAJC226*016TNJ	C	22	16	85	10	125	3.5	6	1	1	332	298	133
TAJD226*016TNJV	D	22	16	85	10	125	3.5	6	1.1	3	369	332	148
TAJC336*016TNJ	C	33	16	85	10	125	5.3	6	1.5	1	271	244	108
TAJD336*016TNJV	D	33	16	85	10	125	5.3	6	0.9	3	408	367	163
TAJY336*016TNJV	Y	33	16	85	10	125	5.3	6	0.9	3	373	335	149
TAJC476*016TNJ	C	47	16	85	10	125	7.5	6	0.5	1	469	422	188
TAJD476*016TNJV	D	47	16	85	10	125	7.5	6	0.9	3	408	367	163
TAJY476*016TNJV	Y	47	16	85	10	125	7.5	6	0.7	3	423	380	169
TAJC686*016TNJ	C	68	16	85	10	125	10.9	6	1.3	1	291	262	116
TAJD686*016TNJV	D	68	16	85	10	125	10.9	6	0.9	3	408	367	163
TAJY686*016TNJV	Y	68	16	85	10	125	10.9	6	0.9	3	373	335	149
TAJD107*016TNJV	D	100	16	85	10	125	16	6	0.6	3	500	450	200
TAJE107*016TNJV	E	100	16	85	10	125	16	6	0.9	3	428	385	171
TAJE157*016TNJV	E	150	16	85	10	125	23	8	0.3	3	742	667	297
20 Volt @ 85°C													
TAJA105*020TNJ	A	1	20	85	13	125	0.5	4	9	1	91	82	37
TAJA155*020TNJ	A	1.5	20	85	13	125	0.5	6	6.5	1	107	97	43
TAJA225*020TNJ	A	2.2	20	85	13	125	0.5	6	5.3	1	119	107	48
TAJB225*020TNJ	B	2.2	20	85	13	125	0.5	6	3.5	1	156	140	62
TAJA335*020TNJ	A	3.3	20	85	13	125	0.7	6	4.5	1	129	116	52
TAJB335*020TNJ	B	3.3	20	85	13	125	0.7	6	3	1	168	151	67
TAJA475*020TNJ	A	4.7	20	85	13	125	0.9	6	4	1	137	123	55
TAJB475*020TNJ	B	4.7	20	85	13	125	0.9	6	3	1	168	151	67
TAJB685*020TNJ	B	6.8	20	85	13	125	1.4	6	2.5	1	184	166	74
TAJC685*020TNJ	C	6.8	20	85	13	125	1.4	6	2	1	235	211	94
TAJB106*020TNJ	B	10	20	85	13	125	2	6	2.1	1	201	181	80
TAJC106*020TNJ	C	10	20	85	13	125	2	6	1.2	1	303	272	121
TAJB156*020TNJ	B	15	20	85	13	125	3	6	2	1	206	186	82
TAJC156*020TNJ	C	15	20	85	13	125	3	6	1.7	1	254	229	102
TAJC226*020TNJ	C	22	20	85	13	125	4.4	6	1.6	1	262	236	105
TAJD226*020TNJV	D	22	20	85	13	125	4.4	6	0.9	3	408	367	163
TAJY226*020TNJV	Y	22	20	85	13	125	4.4	6	0.9	3	373	335	149
TAJC336*020TNJ	C	33	20	85	13	125	6.6	6	1.5	1	271	244	108
TAJD336*020TNJV	D	33	20	85	13	125	6.6	6	0.9	3	408	367	163
TAJY336*020TNJV	Y	33	20	85	13	125	6.6	6	0.6	3	456	411	183
TAJD476*020TNJV	D	47	20	85	13	125	9.4	6	0.9	3	408	367	163
TAJY476*020TNJV	Y	47	20	85	13	125	9.4	6	0.9	3	373	335	149
TAJD686*020TNJV	D	68	20	85	13	125	13.6	6	0.4	3	612	551	245
TAJE686*020TNJV	E	68	20	85	13	125	13.6	6	0.9	3	428	385	171
TAJE107*020TNJV	E	100	20	85	13	125	20	6	0.4	3	642	578	257
25 Volt @ 85°C													
TAJA474*025TNJ	A	0.47	25	85	17	125	0.5	4	14	1	73	66	29
TAJA684*025TNJ	A	0.68	25	85	17	125	0.5	4	10	1	87	78	35
TAJA105*025TNJ	A	1	25	85	17	125	0.5	4	8	1	97	87	39
TAJA155*025TNJ	A	1.5	25	85	17	125	0.5	6	7.5	1	100	90	40
TAJB155*025TNJ	B	1.5	25	85	17	125	0.5	6	5	1	130	117	52
TAJA225*025TNJ	A	2.2	25	85	17	125	0.6	6	7	1	104	93	41
TAJB225*025TNJ	B	2.2	25	85	17	125	0.6	6	4.5	1	137	124	55
TAJA335*025TNJ	A	3.3	25	85	17	125	0.8	6	3.7	1	142	128	57
TAJB335*025TNJ	B	3.3	25	85	17	125	0.8	6	3.5	1	156	140	62
TAJB475*025TNJ	B	4.7	25	85	17	125	1.2	6	1.5	1	238	214	95
TAJC475*025TNJ	C	4.7	25	85	17	125	1.2	6	2.4	1	214	193	86
TAJB685*025TNJ	B	6.8	25	85	17	125	1.7	6	2.8	1	174	157	70
TAJC685*025TNJ	C	6.8	25	85	17	125	1.7	6	2	1	235	211	94
TAJC106*025TNJ	C	10	25	85	17	125	2.5	6	1.8	1	247	222	99
TAJD106*025TNJV	D	10	25	85	17	125	2.5	6	1.2	3	354	318	141
TAJC156*025TNJ	C	15	25	85	17	125	3.8	6	1.6	1	262	236	105
TAJD156*025TNJV	D	15	25	85	17	125	3.8	6	1	3	387	349	155
TAJY156*025TNJV	Y	15	25	85	17	125	3.8	6	1	3	354	318	141
TAJC226*025TNJ	C	22	25	85	17	125	5.5	6	1.4	1	280	252	112
TAJD226*025TNJV	D	22	25	85	17	125	5.5	6	0.9	3	408	367	163
TAJY226*025TNJV	Y	22	25	85	17	125	5.5	6	0.8	3	395	356	158
TAJD336*025TNJV	D	33	25	85	17	125	8.3	6	0.9	3	408	367	163
TAJD476*025TNJV	D	47	25	85	17	125	11.8	6	0.9	3	408	367	163
TAJE476*025TNJV	E	47	25	85	17	125	11.8	6	0.9	3	428	385	171
TAJE107*025TNJV	E	100	25	85	17	125	25	10	0.3	3	742	667	297

TAJ Automotive Range



Standard Tantalum - Automotive Product Range

RATINGS & PART NUMBER REFERENCE

AVX Part No.	Case Size	Capacitance (µF)	Rated Voltage (V)	Rated Temperature (°C)	Category Voltage (V)	Category Temperature (°C)	DCL Max. (µA)	DF Max. (%)	ESR Max. @ 100kHz (Ω)	MSL	100kHz RMS Current (mA)		
											25°C	85°C	125°C
35 Volt @ 85°C													
TAJA334*035TNJ	A	0.33	35	85	23	125	0.5	4	15	1	71	64	28
TAJA474*035TNJ	A	0.47	35	85	23	125	0.5	4	12	1	79	71	32
TAJA684*035TNJ	A	0.68	35	85	23	125	0.5	4	8	1	97	87	39
TAJA105*035TNJ	A	1	35	85	23	125	0.5	4	7.5	1	100	90	40
TAJB105*035TNJ	B	1	35	85	23	125	0.5	4	6.5	1	114	103	46
TAJA155*035TNJ	A	1.5	35	85	23	125	0.5	6	7.5	1	100	90	40
TAJB155*035TNJ	B	1.5	35	85	23	125	0.5	6	5.2	1	128	115	51
TAJB225*035TNJ	B	2.2	35	85	23	125	0.8	6	4.2	1	142	128	57
TAJC225*035TNJ	C	2.2	35	85	23	125	0.8	6	3.5	1	177	160	71
TAJB335*035TNJ	B	3.3	35	85	23	125	1.2	6	3.5	1	156	140	62
TAJC335*035TNJ	C	3.3	35	85	23	125	1.2	6	2.5	1	210	189	84
TAJB475*035TNJ	B	4.7	35	85	23	125	1.6	6	3.1	1	166	149	66
TAJC475*035TNJ	C	4.7	35	85	23	125	1.6	6	2.2	1	224	201	89
TAJD475*035TNJV	D	4.7	35	85	23	125	1.6	6	1.5	3	316	285	126
TAJC685*035TNJ	C	6.8	35	85	23	125	2.4	6	1.8	1	247	222	99
TAJD685*035TNJV	D	6.8	35	85	23	125	2.4	6	1.3	3	340	306	136
TAJC106*035TNJ	C	10	35	85	23	125	3.5	6	1.6	1	262	236	105
TAJD106*035TNJV	D	10	35	85	23	125	3.5	6	1	3	387	349	155
TAJY106*035TNJV	Y	10	35	85	23	125	3.5	6	1	3	354	318	141
TAJD156*035TNJV	D	15	35	85	23	125	5.3	6	0.9	3	408	367	163
TAJY156*035TNJV	Y	15	35	85	23	125	5.3	6	0.6	3	456	411	183
TAJD226*035TNJV	D	22	35	85	23	125	7.7	6	0.9	3	408	367	163
TAJE226*035TNJV	E	22	35	85	23	125	7.7	6	0.5	3	574	517	230
TAJD336*035TNJV	D	33	35	85	23	125	11.6	6	0.9	3	408	367	163
TAJE336*035TNJV	E	33	35	85	23	125	11.6	6	0.9	3	428	385	171
50 Volt @ 85°C													
TAJA224*050TNJ	A	0.22	50	85	33	125	0.5	4	18	1	65	58	26
TAJA334*050TNJ	A	0.33	50	85	33	125	0.5	4	17	1	66	60	27
TAJA474*050TNJ	A	0.47	50	85	33	125	0.5	4	9.5	1	89	80	36
TAJB474*050TNJ	B	0.47	50	85	33	125	0.7	4	9.5	1	95	85	38
TAJB684*050TNJ	B	0.68	50	85	33	125	0.5	4	8	1	103	93	41
TAJB105*050TNJ	B	1	50	85	33	125	0.5	6	7	1	110	99	44
TAJC105*050TNJ	C	1	50	85	33	125	0.5	4	5.5	1	141	127	57
TAJC155*050TNJ	C	1.5	50	85	33	125	0.8	6	4.5	1	156	141	63
TAJC225*050TNJ	C	2.2	50	85	33	125	1.1	8	2.5	1	210	189	84
TAJD225*050TNJV	D	2.2	50	85	33	125	1.1	6	2.5	3	245	220	98
TAJC335*050TNJ	C	3.3	50	85	33	125	1.6	6	2.5	1	210	189	84
TAJD335*050TNJV	D	3.3	50	85	33	125	1.7	6	2	3	274	246	110
TAJC475*050TNJ	C	4.7	50	85	33	125	0.5	4	1.4	1	280	252	112
TAJD475*050TNJV	D	4.7	50	85	33	125	2.4	6	1.4	3	327	295	131
TAJD685*050TNJV	D	6.8	50	85	33	125	3.4	6	1	3	387	349	155
TAJD106*050TNJV	D	10	50	85	33	125	5	6	0.8	3	433	390	173
TAJE106*050TNJV	E	10	50	85	33	125	5	6	1	3	406	366	162
TAJE156*050TNJV	E	15	50	85	33	125	7.5	6	0.6	3	524	472	210

Moisture Sensitivity Level (MSL) is defined according to J-STD-020

*Please use "U" instead of "T" in the suffix letter for 13" reel packaging

Please use specific PN for automotive version – see "HOW TO ORDER".

All technical data relates to an ambient temperature of +25°C. Capacitance and DF are measured at 120Hz, 0.5V RMS with a maximum DC bias of 2.2 volts.

DCL is measured at rated voltage after 5 minutes.

For typical weight and composition see page 222.

NOTE: AVX reserves the right to supply a higher voltage rating or tighter tolerance part in the same case size, to the same reliability standards.

TAJ Automotive Range



Standard Tantalum - Automotive Product Range

QUALIFICATION TABLE

TEST	TAJ automotive series (Temperature range -55°C to +125°C)										
	Condition			Characteristics							
Endurance	Apply rated voltage (UR) at 85±2°C and / or category voltage (Uc) at 125±2°C for 2000 +48/-0 hours through a circuit impedance of ≤0.1Ω/V. Stabilize at room temperature for 1-2 hours before measuring.			Visual examination	no visible damage						
				DCL	1.25 x initial limit						
				ΔC/C	within ±10% of initial value						
				DF	initial limit						
				ESR	initial limit						
Storage Life	Store at 125°C, no voltage applied, for 2000 +48/-0 hours. Stabilize at room temperature for 1-2 hours before measuring.			Visual examination	no visible damage						
				DCL	1.25 x initial limit						
				ΔC/C	within ±10% of initial value						
				DF	initial limit						
				ESR	initial limit						
Humidity	Store at 65±2°C and 95±2% relative humidity for 500 +48/-0 hours, with no applied voltage. Stabilize at room temperature and humidity for 1-2 hours before measuring.			Visual examination	no visible damage						
				DCL	1.5 x initial limit						
				ΔC/C	within ±10% of initial value						
				DF	1.2 x initial limit						
				ESR	initial limit						
Biased Humidity	Determine after leaving for 1000 hours at 85±2°C, 85% relative humidity and rated voltage and then recovery 1-2 hours at room temperature.			Visual examination	no visible damage						
				DCL	2 x initial limit						
				ΔC/C	within ±10% of initial value						
				DF	1.2 x initial limit						
				ESR	initial limit						
Temperature Stability	Step	Temperature°C	Duration(min)		+20°C	-55°C	+20°C	+85°C	+125°C	+20°C	
	1	+20±2	15	DCL	IL*	n/a	IL*	10 x IL*	12.5 x IL*	IL*	
	2	-55+0/-3	15	ΔC/C	n/a	+0/-10%	±5%	+10/-0%	+12/-0%	±5%	
	3	+20±2	15	DF	IL*	1.5 x IL*	IL*	1.5 x IL*	2 x IL*	IL*	
	4	+85+3/-0	15	ESR	IL*	2 x IL*	IL*	IL*	IL*	IL*	
	5	+125+3/-0	15								
	6	+20±2	15								
Surge Voltage	Apply 1.3x category voltage (Uc) at 125 +3/-0°C for 1,000 cycles of duration 6 mins. (30 secs. charge, 5 min. 30 sec. discharge) through a charge / discharge resistance of 1000±100Ω			Visual examination	no visible damage						
				DCL	initial limit						
				ΔC/C	within ±5% of initial value						
				DF	initial limit						
				ESR	initial limit						
Mechanical Shock	MIL-STD-202, Method 213, Condition F			Visual examination	no visible damage						
				DCL	initial limit						
				ΔC/C	within ±5% of initial value						
				DF	initial limit						
				ESR	initial limit						
Vibration	MIL-STD-202, Method 204, Condition D			Visual examination	no visible damage						
				DCL	initial limit						
				ΔC/C	within ±5% of initial value						
				DF	initial limit						
				ESR	initial limit						

*Initial Limit

TAJ Automotive Range



Standard Tantalum - Automotive Product Range

AVX SOLID ELECTROLYTIC CAPACITOR ROADMAP

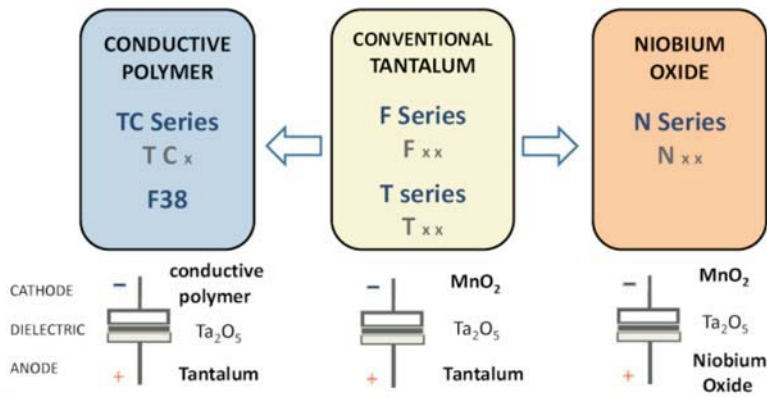

FIVE CAPACITOR CONSTRUCTION STYLES

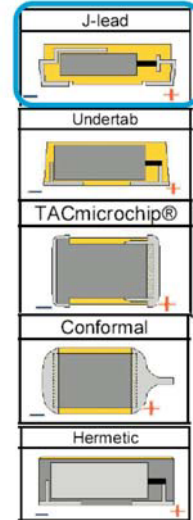

SERIES LINE UP: CONVENTIONAL SMD MnO₂

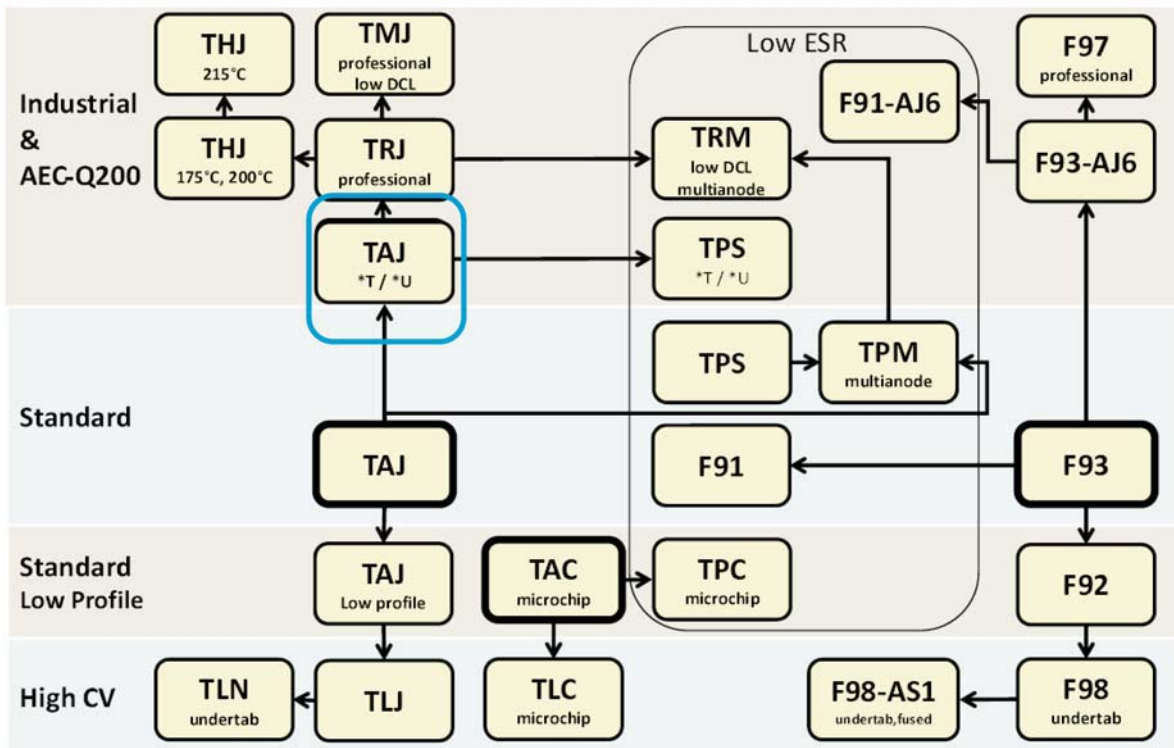

F92 Series



Resin-Molded Chip, Low Profile J-Lead



FEATURES

- Compliant to the RoHS2 directive 2011/65/EU
- SMD J-lead
- Low profile case sizes

APPLICATIONS

- Handheld electronics
- USB accessories



CASE DIMENSIONS: millimeters (inches)

Code	EIA Code	EIA Metric	L	W ₁	W ₂	H	S
A	1206	3216-12	3.20 ± 0.20 (0.126 ± 0.008)	1.60 ± 0.20 (0.063 ± 0.008)	1.20 ± 0.10 (0.047 ± 0.004)	1.10 ± 0.10 (0.043 ± 0.004)	0.80 ± 0.20 (0.031 ± 0.008)
B	1311	3428-12	3.40 ± 0.20 (0.134 ± 0.008)	2.80 ± 0.20 (0.110 ± 0.008)	2.30 ± 0.10 (0.091 ± 0.004)	1.10 ± 0.10 (0.043 ± 0.004)	0.80 ± 0.20 (0.031 ± 0.008)
P	0805	2012-12	2.00 ± 0.20 (0.079 ± 0.008)	1.25 ± 0.10 (0.049 ± 0.004)	0.90 ± 0.10 (0.035 ± 0.004)	1.10 ± 0.10 (0.043 ± 0.004)	0.50 ± 0.20 (0.020 ± 0.008)

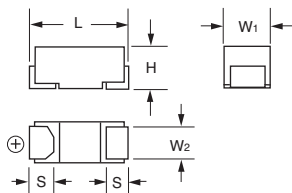

MARKING

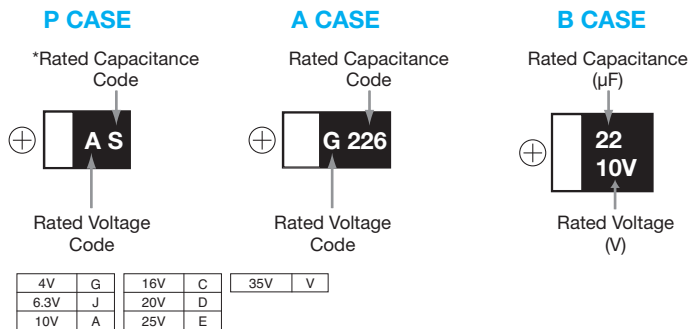

*Capacitance code of "P" case products are as shown below.

HOW TO ORDER

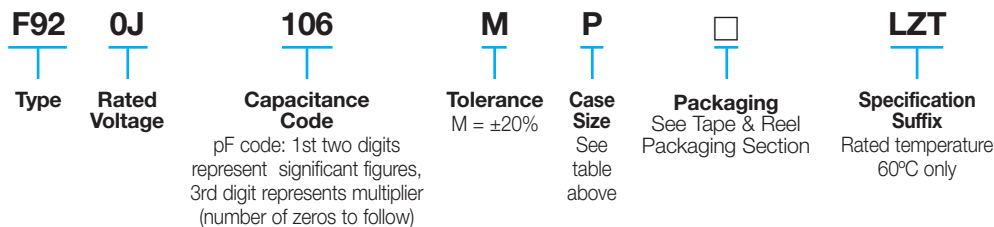

TECHNICAL SPECIFICATIONS

Category Temperature Range:	-55 to +125°C								
Rated Temperature:	+85°C								
Capacitance Tolerance:	±20% at 120Hz								
Dissipation Factor:	Refer to next page								
ESR 100kHz:	Refer to next page								
Leakage Current:	After 1 minute's application of rated voltage, leakage current at 20°C is not more than 0.01CV or 0.5µA, whichever is greater. After 1 minute's application of rated voltage, leakage current at 85°C is not more than 0.1CV or 5µA, whichever is greater. After 1 minute's application of derated voltage, leakage current at 125°C is not more than 0.125CV or 6.3µA, whichever is greater.								
Capacitance Change By Temperature	<table border="1"> <thead> <tr> <th>P Case</th> <th>A, B Case</th> </tr> </thead> <tbody> <tr> <td>+20% Max. at +125°C</td> <td>+15% Max. at +125°C</td> </tr> <tr> <td>+15% Max. at +85°C</td> <td>+10% Max. at +85°C</td> </tr> <tr> <td>-15% Max. at -55°C</td> <td>-10% Max. at -55°C</td> </tr> </tbody> </table>	P Case	A, B Case	+20% Max. at +125°C	+15% Max. at +125°C	+15% Max. at +85°C	+10% Max. at +85°C	-15% Max. at -55°C	-10% Max. at -55°C
P Case	A, B Case								
+20% Max. at +125°C	+15% Max. at +125°C								
+15% Max. at +85°C	+10% Max. at +85°C								
-15% Max. at -55°C	-10% Max. at -55°C								



F92 Series



Resin-Molded Chip, Low Profile J-Lead

CAPACITANCE AND RATED VOLTAGE RANGE (LETTER DENOTES CASE SIZE)

Capacitance		Rated Voltage							*Cap Code
μF	Code	4V (0G)	6.3V (0J)	10V (1A)	16V (1C)	20V (1D)	25V (1E)	35V (1V)	
0.22	224							A	J
0.33	334							A	N
0.47	474				P	A/P		A	S
0.68	684				P	A			W
1.0	105			P	P	A/P	A/P	A	A
1.5	155			P	P	A			E
2.2	225		P	P	A/P	A/P*	A/B	B	J
3.3	335	P	P	A/P	A			B	N
4.7	475	P	P	A/P	A/B/P*	A/B	A/B		S
6.8	685	P	P	A/P	B				w
10	106	A/P	A/P	A/P	A/B	B			a
15	156	P	A/P	A					e
22	226	A/P	A/P	A/B	B				J
33	336	A/P	A/B	B					n
47	476	A/B/P*	A/B	B					s
68	686	A/B							w
100	107	A/B	A**/B						A
150	157	B							E
220	227	B*							J

Available Ratings

*Codes under development – subject to change

**Rated temperature 60°C only. Please contact AVX when you need detail spec.

Please contact to your local AVX sales office when these series are being designed in your application.

F92 Series



Resin-Molded Chip, Low Profile J-Lead

RATINGS & PART NUMBER REFERENCE

AVX Part No.	Case Size	Capacitance (µF)	Rated Voltage (V)	DCL (µA)	DF @ 120Hz (%)	ESR @ 100kHz (Ω)	*1 ΔC/C (%)
4 Volt							
F920G335MPA	P	3.3	4	0.5	8	12.0	*
F920G475MPA	P	4.7	4	0.5	8	6.0	*
F920G685MPA	P	6.8	4	0.5	10	6.0	*
F920G106MAA	A	10	4	0.5	8	4.0	*
F920G106MPA	P	10	4	0.5	10	6.0	*
F920G156MPA	P	15	4	0.6	10	5.0	*
F920G226MAA	A	22	4	0.9	12	2.8	*
F920G226MPA	P	22	4	0.9	20	5.0	*
F920G336MAA	A	33	4	1.3	12	2.8	*
F920G336MPA	P	33	4	1.3	20	4.0	*
F920G476MAA	A	47	4	1.9	18	2.8	*
F920G476MBA	B	47	4	1.9	12	1.7	*
F920G686MAA	A	68	4	2.7	25	2.8	±15
F920G686MBA	B	68	4	2.7	18	1.5	*
F920G107MAA	A	100	4	4.0	30	2.8	±15
F920G107MBA	B	100	4	4.0	18	1.3	*
F920G157MBA	B	150	4	6.0	25	1.3	±15
6.3 Volt							
F920J225MPA	P	2.2	6.3	0.5	8	12.0	*
F920J335MPA	P	3.3	6.3	0.5	8	12.0	*
F920J475MPA	P	4.7	6.3	0.5	8	6.0	*
F920J685MPA	P	6.8	6.3	0.5	10	6.0	*
F920J106MAA	A	10	6.3	0.6	8	4.0	*
F920J106MPA	P	10	6.3	0.6	10	6.0	*
F920J156MAA	A	15	6.3	0.9	8	4.0	*
F920J156MPA	P	15	6.3	0.9	10	6.0	*
F920J226MAA	A	22	6.3	1.4	12	2.8	*
F920J226MPA	P	22	6.3	1.4	20	5.0	*
F920J336MAA	A	33	6.3	2.1	12	2.8	*
F920J336MBA	B	33	6.3	2.1	12	1.7	*
F920J476MAA	A	47	6.3	3.0	18	2.8	±15
F920J476MBA	B	47	6.3	3.0	12	1.7	*
F920J107MAALZT	A	100	6.3	63.0	40	3.0	±20
F920J107MBA	B	100	6.3	6.3	20	1.3	±15
10 Volt							
F921A105MPA	P	1	10	0.5	8	12.0	*
F921A155MPA	P	1.5	10	0.5	8	12.0	*
F921A225MPA	P	2.2	10	0.5	8	12.0	*
F921A335MAA	A	3.3	10	0.5	6	7.0	*
F921A335MPA	P	3.3	10	0.5	8	12.0	*
F921A475MAA	A	4.7	10	0.5	6	4.0	*
F921A475MPA	P	4.7	10	0.5	8	6.0	*
F921A685MAA	A	6.8	10	0.7	6	4.0	*
F921A685MPA	P	6.8	10	0.7	8	6.0	*
F921A106MAA	A	10	10	1.0	8	4.0	*

AVX Part No.	Case Size	Capacitance (µF)	Rated Voltage (V)	DCL (µA)	DF @ 120Hz (%)	ESR @ 100kHz (Ω)	*1 ΔC/C (%)
F921A106MPA	P	10	10	1.0	14	6.0	*
F921A156MAA	A	15	10	1.5	8	4.0	*
F921A226MAA	A	22	10	2.2	14	4.0	±15
F921A226MBA	B	22	10	2.2	8	1.9	*
F921A336MBA	B	33	10	3.3	12	1.9	*
F921A476MBA	B	47	10	4.7	18	1.9	±15
16 Volt							
F921C474MPA	P	0.47	16	0.5	8	20.0	*
F921C684MPA	P	0.68	16	0.5	8	12.0	*
F921C105MPA	P	1	16	0.5	8	12.0	*
F921C155MPA	P	1.5	16	0.5	8	12.0	*
F921C225MAA	A	2.2	16	0.5	6	7.0	*
F921C225MPA	P	2.2	16	0.5	8	12.0	*
F921C335MAA	A	3.3	16	0.5	6	7.0	*
F921C475MAA	A	4.7	16	0.8	6	7.0	*
F921C475MBA	B	4.7	16	0.8	6	3.0	*
F921C685MBA	B	6.8	16	1.1	6	3.0	*
F921C106MAA	A	10	16	1.6	8	7.0	±15
F921C106MBA	B	10	16	1.6	6	2.0	*
F921C226MBA	B	22	16	3.5	12	2.0	±15
20 Volt							
F921D474MAA	A	0.47	20	0.5	4	10.0	*
F921D474MPA	P	0.47	20	0.5	8	20.0	*
F921D684MAA	A	0.68	20	0.5	4	10.0	*
F921D105MAA	A	1	20	0.5	4	10.0	*
F921D105MPA	P	1	20	0.5	8	20.0	*
F921D155MAA	A	1.5	20	0.5	6	7.4	*
F921D225MAA	A	2.2	20	0.5	6	7.0	*
F921D475MAA	A	4.7	20	0.9	10	7.0	±10
F921D475MBA	B	4.7	20	0.9	6	3.0	*
F921D106MBA	B	10	20	2.0	8	3.0	±10
25 Volt							
F921E105MAA	A	1	25	0.5	6	10.0	*
F921E105MPA	P	1	25	0.5	8	20.0	*
F921E225MAA	A	2.2	25	0.6	8	10.0	±15
F921E225MBA	B	2.2	25	0.6	6	4.0	*
F921E475MAA	A	4.7	25	1.2	10	7.0	±10
F921E475MBA	B	4.7	25	1.2	6	3.0	*
35 Volt							
F921V224MAA	A	0.22	35	0.5	4	10.0	*
F921V334MAA	A	0.33	35	0.5	4	10.0	*
F921V474MAA	A	0.47	35	0.5	4	10.0	*
F921V105MAA	A	1	35	0.5	6	10.0	*
F921V225MBA	B	2.2	35	0.8	6	4.0	±10
F921V335MBA	B	3.3	35	1.2	10	4.0	±10

* In case of capacitance tolerance ± 10% type, "K" will be put at 9th digit of type numbering system

1: ΔC/C Marked ""

Item	P Case (%)	A, B Case (%)
Damp Heat	±20	±10
Temperature cycles	±10	±5
Resistance soldering heat	±10	±5
Surge	±10	±5
Endurance	±10	±10

We can consider the type of compliance to AEC-Q200.
Please contact to your local AVX sales office
when these series are being designed in your application.

QUALIFICATION TABLE

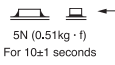
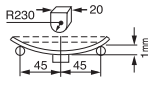
TEST	F92 series (Temperature range -55°C to +125°C)	
	Condition	
	P Case	A, B Case
Damp Heat (Steady State)	At 40°C, 90 to 95% R.H., 500 hours (No voltage applied)	
	Capacitance Change Refer to page 27 (*1)	Refer to page 27 (*1)
	Dissipation Factor 150% or less than the initial specified value Leakage Current Initial specified value or less	Initial specified value or less Initial specified value or less
Temperature Cycles	-55°C / +125°C, 30 minutes each, 5 cycles	
	Capacitance Change Refer to page 27 (*1)	Refer to page 27 (*1)
	Dissipation Factor 150% or less than the initial specified value Leakage Current Initial specified value or less	Initial specified value or less Initial specified value or less
Resistance to Soldering Heat	10 seconds reflow at 260°C, 5 seconds immersion at 260°C.	
	Capacitance Change Refer to page 27 (*1)	Refer to page 27 (*1)
	Dissipation Factor 150% or less than the initial specified value Leakage Current Initial specified value or less	Initial specified value or less Initial specified value or less
Surge	After application of surge voltage in series with a 33Ω (For "P" case: 1kΩ) resistor at the rate of 30 seconds ON, 30 seconds OFF, for 1000 successive test cycles at 85°C, capacitors shall meet the characteristic requirements in the table above.	
	Capacitance Change Refer to page 27 (*1)	Refer to page 27 (*1)
	Dissipation Factor 150% or less than the initial specified value Leakage Current Initial specified value or less	Initial specified value or less Initial specified value or less
Endurance	After 2000 hours' application of rated voltage in series with a 3Ω resistor at 85°C, or derated voltage in series with a 3Ω resistor at 125°C, capacitors shall meet the characteristic requirements in the table above.	
	Capacitance Change Refer to page 27 (*1)	Refer to page 27 (*1)
	Dissipation Factor 150% or less than the initial specified value Leakage Current Initial specified value or less	Initial specified value or less Initial specified value or less
Shear Test	After applying the pressure load of 5N for 10±1 seconds horizontally to the center of capacitor side body which has no electrode and has been soldered beforehand on a substrate, there shall be found neither exfoliation nor its sign at the terminal electrode. 	
Terminal Strength	Keeping a capacitor surface-mounted on a substrate upside down and supporting the substrate at both of the opposite bottom points 45mm apart from the center of capacitor, the pressure strength is applied with a specified jig at the center of substrate so that the substrate may bend by 1mm as illustrated. Then, there shall be found no remarkable abnormality on the capacitor terminals. 	

F93 Series



Resin-Molded Chip, Standard Tantalum J-Lead



FEATURES

- Compliant to the RoHS2 directive 2011/65/EU
- SMD J-lead

APPLICATIONS

- Low power DC/DC



CASE DIMENSIONS: millimeters (inches)

Code	EIA Code	EIA Metric	L	W ₁	W ₂	H	S
A	1206	3216-18	3.20 ± 0.20 (0.126 ± 0.008)	1.60 ± 0.20 (0.063 ± 0.008)	1.20 ± 0.10 (0.047 ± 0.004)	1.60 ± 0.20 (0.063 ± 0.008)	0.80 ± 0.20 (0.031 ± 0.008)
B	1210	3528-21	3.50 ± 0.20 (0.126 ± 0.008)	2.80 ± 0.20 (0.110 ± 0.008)	2.20 ± 0.10 (0.087 ± 0.004)	1.90 ± 0.20 (0.075 ± 0.008)	0.80 ± 0.20 (0.031 ± 0.008)
C	2312	6032-27	6.00 ± 0.20 (0.236 ± 0.008)	3.20 ± 0.20 (0.126 ± 0.008)	2.20 ± 0.10 (0.087 ± 0.004)	2.50 ± 0.20 (0.098 ± 0.008)	1.30 ± 0.20 (0.051 ± 0.008)
N	2917	7343-30	7.30 ± 0.20 (0.287 ± 0.008)	4.30 ± 0.20 (0.169 ± 0.008)	2.40 ± 0.10 (0.094 ± 0.004)	2.80 ± 0.20 (0.110 ± 0.008)	1.30 ± 0.20 (0.051 ± 0.008)

A, B CASE

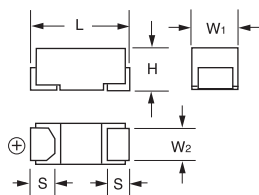

C, N CASE

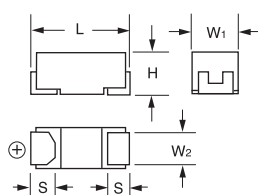

MARKING

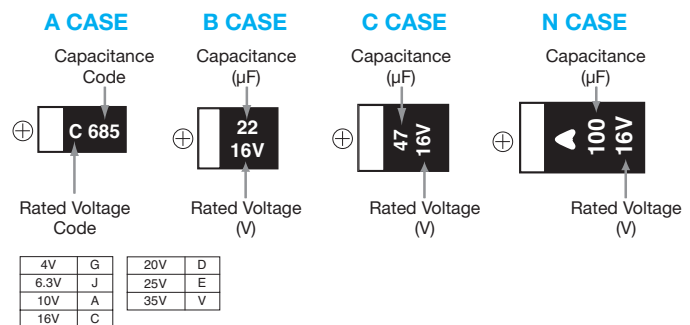

HOW TO ORDER

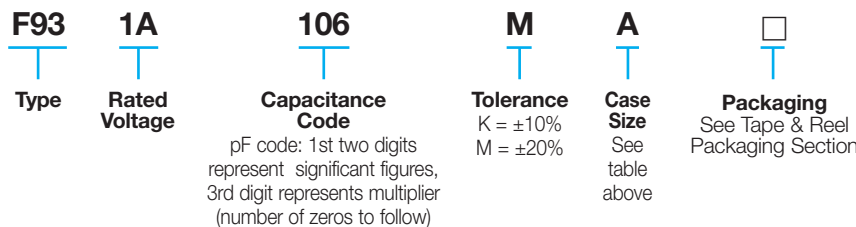

TECHNICAL SPECIFICATIONS

Category Temperature Range:	-55 to +125°C
Rated Temperature:	+85°C
Capacitance Tolerance:	±20%, ±10% at 120Hz
Dissipation Factor:	Refer to next page
ESR 100kHz:	Refer to next page
Leakage Current:	After 1 minute's application of rated voltage, leakage current at 20°C is not more than 0.01CV or 0.5µA, whichever is greater. After 1 minute's application of rated voltage, leakage current at 85°C is not more than 0.1CV or 5µA, whichever is greater. After 1 minute's application of derated voltage, leakage current at 125°C is not more than 0.125CV or 6.3µA, whichever is greater.
Capacitance Change By Temperature	+15% Max. at +125°C +10% Max. at +85°C -10% Max. at -55°C

F93 Series



Resin-Molded Chip, Standard Tantalum J-Lead

CAPACITANCE AND RATED VOLTAGE RANGE (LETTER DENOTES CASE SIZE)

Capacitance		Rated Voltage						
μF	Code	4V (0G)	6.3V (0J)	10V (1A)	16V (1C)	20V (1D)	25V (1E)	35V (1V)
0.68	684							A
1.0	105				A		A	A
1.5	155				A		A	A
2.2	225				A	A	A	A/B
3.3	335				A	A	A	B
4.7	475			A	A	A/B	A/B	B/C
6.8	685			A	A	A/B		C
10	106		A	A	A/B	A/B	B/C	C
15	156		A	A	A/B	C	C	N
22	226	A	A	A/B	A/B/C	B/C	C/N	N
33	336	A	A	A/B	B/C	C/N	N	N
47	476	A	A/B	A/B/C	B/C/N	C/N	N	
68	686	A	A/B	B/C	C/N	N*		
100	107	A/B	A/B/C	B/C/N	C/N			
150	157	B	B/C	C/N	N			
220	227	A*/B/C	B/C/N	C/N	N			
330	337	C	C*/N	N				
470	447	N	N					
680	687	N	N*					

Released ratings

*Ratings under development – subject to change

Please contact to your local AVX sales office when these series are being designed in your application.

F93 Series



Resin-Molded Chip, Standard Tantalum J-Lead

RATINGS & PART NUMBER REFERENCE

AVX Part No.	Case Size	Capacitance (µF)	Rated Voltage (V)	DCL (µA)	DF @ 120Hz (%)	ESR @ 100kHz (Ω)	*1 ΔC/C (%)
4 Volt							
F930G226MAA	A	22	4	0.9	6	2.5	*
F930G336MAA	A	33	4	1.3	8	2.5	*
F930G476MAA	A	47	4	1.9	18	2.5	*
F930G686MAA	A	68	4	2.7	24	2.5	*
F930G107MAA	A	100	4	4.0	30	2.0	*
F930G107MBA	B	100	4	4.0	14	0.9	*
F930G157MBA	B	150	4	6.0	16	0.7	*
F930G227MBA	B	220	4	8.8	18	0.7	*
F930G227MCC	C	220	4	8.8	12	0.7	*
F930G337MCC	C	330	4	13.2	14	0.7	*
F930G477MNC	N	470	4	18.8	16	0.3	*
F930G687MNC	N	680	4	27.2	18	0.3	*
6.3 Volt							
F930J106MAA	A	10	6.3	0.6	6	3.0	*
F930J156MAA	A	15	6.3	0.9	6	2.9	*
F930J226MAA	A	22	6.3	1.4	8	2.5	*
F930J336MAA	A	33	6.3	2.1	8	2.5	*
F930J476MAA	A	47	6.3	3.0	18	2.5	*
F930J476MBA	B	47	6.3	3.0	6	1.0	*
F930J686MAA	A	68	6.3	4.3	20	2.0	*
F930J686MBA	B	68	6.3	4.3	8	1.0	*
F930J107MAA	A	100	6.3	6.3	35	2.0	±15
F930J107MBA	B	100	6.3	6.3	14	0.9	*
F930J107MCC	C	100	6.3	6.3	8	0.7	*
F930J157MBA	B	150	6.3	9.5	18	0.9	*
F930J157MCC	C	150	6.3	9.5	12	0.7	*
F930J227MBA	B	220	6.3	13.9	30	1.2	±15
F930J227MCC	C	220	6.3	13.9	14	0.7	*
F930J227MNC	N	220	6.3	13.9	10	0.5	*
F930J337MNC	N	330	6.3	20.8	14	0.5	*
F930J477MNC	N	470	6.3	29.6	16	0.3	*
10 Volt							
F931A475MAA	A	4.7	10	0.5	6	4.0	*
F931A685MAA	A	6.8	10	0.7	6	3.5	*
F931A106MAA	A	10	10	1.0	6	3.0	*
F931A156MAA	A	15	10	1.5	8	2.9	*
F931A226MAA	A	22	10	2.2	12	2.5	*
F931A226MBA	B	22	10	2.2	6	1.9	*
F931A336MAA	A	33	10	3.3	18	2.5	*
F931A336MBA	B	33	10	3.3	8	1.4	*
F931A476MAA	A	47	10	4.7	40	2.0	±15
F931A476MBA	B	47	10	4.7	8	1.0	*
F931A476MCC	C	47	10	4.7	6	0.9	*
F931A686MBA	B	68	10	6.8	12	0.9	±15
F931A686MCC	C	68	10	6.8	8	0.8	*
F931A107MBA	B	100	10	10.0	18	1.2	±15
F931A107MCC	C	100	10	10.0	10	0.7	*
F931A107MNC	N	100	10	10.0	8	0.6	*
F931A157MCC	C	150	10	15.0	14	0.7	*
F931A157MNC	N	150	10	15.0	10	0.6	*
F931A227MCC	C	220	10	22.0	40	0.9	±15
F931A227MNC	N	220	10	22.0	12	0.5	*
F931A337MNC	N	330	10	33.0	18	0.5	*
16 Volt							
F931C105MAA	A	1	16	0.5	4	7.5	*
F931C155MAA	A	1.5	16	0.5	4	6.0	*
F931C225MAA	A	2.2	16	0.5	4	5.0	*
F931C335MAA	A	3.3	16	0.5	4	4.5	*
F931C475MAA	A	4.7	16	0.8	6	4.0	*
F931C685MAA	A	6.8	16	1.1	6	3.5	*

AVX Part No.	Case Size	Capacitance (µF)	Rated Voltage (V)	DCL (µA)	DF @ 120Hz (%)	ESR @ 100kHz (Ω)	*1 ΔC/C (%)
F931C106MAA	A	10	16	1.6	6	3.0	*
F931C106MBA	B	10	16	1.6	6	2.0	*
F931C156MAA	A	15	16	2.4	10	3.0	*
F931C156MBA	B	15	16	2.4	6	2.0	*
F931C226MAA	A	22	16	3.5	15	3.0	±15
F931C226MBA	B	22	16	3.5	8	1.9	*
F931C226MCC	C	22	16	3.5	6	1.1	*
F931C336MBA	B	33	16	5.3	8	1.9	*
F931C336MCC	C	33	16	5.3	6	1.1	*
F931C476MBA	B	47	16	7.5	16	2.0	±15
F931C476MCC	C	47	16	7.5	8	0.9	*
F931C476MNC	N	47	16	7.5	6	0.7	*
F931C686MCC	C	68	16	10.9	10	0.8	±10
F931C686MNC	N	68	16	10.9	6	0.6	*
F931C107MCC	C	100	16	16.0	15	0.7	±10
F931C107MNC	N	100	16	16.0	10	0.6	*
F931C157MNC	N	150	16	24.0	15	0.6	*
F931C227MNC	N	220	16	35.2	25	0.7	±10
20 Volt							
F931D225MAA	A	2.2	20	0.5	4	5.0	*
F931D335MAA	A	3.3	20	0.7	4	4.5	*
F931D475MAA	A	4.7	20	0.9	6	3.0	*
F931D475MBA	B	4.7	20	0.9	6	2.8	*
F931D685MAA	A	6.8	20	1.4	6	3.5	*
F931D685MBA	B	6.8	20	1.4	6	2.5	*
F931D106MAA	A	10	20	2.0	8	3.5	*
F931D106MBA	B	10	20	2.0	6	2.1	*
F931D156MCC	C	15	20	3.0	6	1.2	*
F931D226MBA	B	22	20	4.4	8	1.9	*
F931D226MCC	C	22	20	4.4	8	1.1	*
F931D336MCC	C	33	20	6.6	8	1.1	*
F931D336MNC	N	33	20	6.6	6	0.7	*
F931D476MCC	C	47	20	9.4	10	1.1	*
F931D476MNC	N	47	20	9.4	8	0.7	*
25 Volt							
F931E105MAA	A	1	25	0.5	4	7.5	*
F931E155MAA	A	1.5	25	0.5	4	6.7	*
F931E225MAA	A	2.2	25	0.6	6	6.3	*
F931E335MAA	A	3.3	25	0.8	6	6.0	*
F931E475MAA	A	4.7	25	1.2	8	4.0	*
F931E475MBA	B	4.7	25	1.2	6	2.8	*
F931E106MBA	B	10	25	2.5	12	1.9	*
F931E106MCC	C	10	25	2.5	6	1.5	*
F931E156MCC	C	15	25	3.8	8	1.2	*
F931E226MCC	C	22	25	5.5	8	1.1	*
F931E226MNC	N	22	25	5.5	6	0.7	*
F931E336MNC	N	33	25	8.3	8	0.7	*
F931E476MNC	N	47	25	11.8	8	0.7	*
35 Volt							
F931V684MAA	A	0.68	35	0.5	4	7.6	*
F931V105MAA	A	1	35	0.5	4	7.5	*
F931V155MAA	A	1.5	35	0.5	6	7.5	*
F931V225MAA	A	2.2	35	0.8	6	7.0	*
F931V225MBA	B	2.2	35	0.8	4	3.8	*
F931V335MBA	B	3.3	35	1.2	4	3.5	*
F931V475MBA	B	4.7	35	1.6	8	3.1	*
F931V475MCC	C	4.7	35	1.6	6	1.8	*
F931V685MCC	C	6.8	35	2.4	6	1.8	*
F931V106MCC	C	10	35	3.5	6	1.6	*
F931V156MNC	N	15	35	5.3	6	0.7	*
F931V226MNC	N	22	35	7.7	8	0.7	*
F931V336MNC	N	33	35	11.6	8	0.7	*

1: ΔC/C Marked “”

Item	All Case (%)
Damp Heat	±10
Temperature cycles	±5
Resistance soldering heat	±5
Surge	±5
Endurance	±10

* In case of capacitance tolerance ± 10% type, “K” will be put at 9th digit of type numbering system

QUALIFICATION TABLE

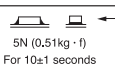
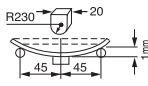
TEST	F93 series (Temperature range -55°C to +125°C)	
	Condition	
Damp Heat (Steady State)	At 40°C, 90 to 95% R.H., 500 hours (No voltage applied) Capacitance Change Refer to page 31 (*1) Dissipation Factor Initial specified value or less Leakage Current Initial specified value or less	
Temperature Cycles	-55°C / +125°C, 30 minutes each, 5 cycles Capacitance Change Refer to page 31 (*1) Dissipation Factor Initial specified value or less Leakage Current Initial specified value or less	
Resistance to Soldering Heat	10 seconds reflow at 260°C, 5 seconds immersion at 260°C. Capacitance Change Refer to page 31 (*1) Dissipation Factor Initial specified value or less Leakage Current Initial specified value or less	
Surge	After application of surge voltage in series with a 33Ω resistor at the rate of 30 seconds ON, 30 seconds OFF, for 1000 successive test cycles at 85°C, capacitors shall meet the characteristic requirements in the table above. Capacitance Change Refer to page 31 (*1) Dissipation Factor Initial specified value or less Leakage Current Initial specified value or less	
Endurance	After 2000 hours' application of rated voltage in series with a 3Ω resistor at 85°C, or derated voltage in series with a 3Ω resistor at 125°C, capacitors shall meet the characteristic requirements in the table above. Capacitance Change Refer to page 31 (*1) Dissipation Factor Initial specified value or less Leakage Current Initial specified value or less	
Shear Test	After applying the pressure load of 5N for 10±1 seconds horizontally to the center of capacitor side body which has no electrode and has been soldered beforehand on a substrate, there shall be found neither exfoliation nor its sign at the terminal electrode.	
Terminal Strength	Keeping a capacitor surface-mounted on a substrate upside down and supporting the substrate at both of the opposite bottom points 45mm apart from the center of capacitor, the pressure strength is applied with a specified jig at the center of substrate so that the substrate may bend by 1mm as illustrated. Then, there shall be found no remarkable abnormality on the capacitor terminals.	
Failure Rate	1% per 1000 hours at 85°C, VR with 0.1Ω/V series impedance, 60% confidence level.	

We can supply the type of compliance to AEC-Q200. Please contact to your local AVX sales office when these series are being designed in your application.

F93-AJ6 Series



Resin-Molded Chip - Automotive Product Range



FEATURES

- Compliant to the RoHS2 directive 2011/65/EU
- Compliant to AEC-Q200

APPLICATIONS

- Cabin electronics
- Infotainment



CASE DIMENSIONS: millimeters (inches)

Code	EIA Code	EIA Metric	L	W ₁	W ₂	H	S
A	1206	3216-18	3.20 ± 0.20 (0.126 ± 0.008)	1.60 ± 0.20 (0.063 ± 0.008)	1.20 ± 0.10 (0.047 ± 0.004)	1.60 ± 0.20 (0.063 ± 0.008)	0.80 ± 0.20 (0.031 ± 0.008)
B	1210	3528-21	3.50 ± 0.20 (0.126 ± 0.008)	2.80 ± 0.20 (0.110 ± 0.008)	2.20 ± 0.10 (0.087 ± 0.004)	1.90 ± 0.20 (0.075 ± 0.008)	0.80 ± 0.20 (0.031 ± 0.008)
C	2312	6032-27	6.00 ± 0.20 (0.236 ± 0.008)	3.20 ± 0.20 (0.126 ± 0.008)	2.20 ± 0.10 (0.087 ± 0.004)	2.50 ± 0.20 (0.098 ± 0.008)	1.30 ± 0.20 (0.051 ± 0.008)
N	2917	7343-30	7.30 ± 0.20 (0.287 ± 0.008)	4.30 ± 0.20 (0.169 ± 0.008)	2.40 ± 0.10 (0.094 ± 0.004)	2.80 ± 0.20 (0.110 ± 0.008)	1.30 ± 0.20 (0.051 ± 0.008)

A, B CASE

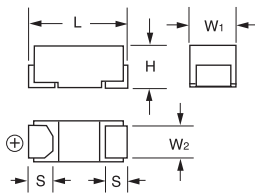

C, N CASE

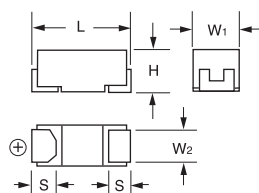

MARKING

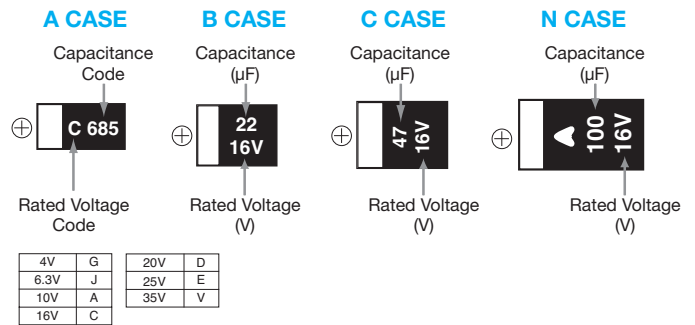

HOW TO ORDER

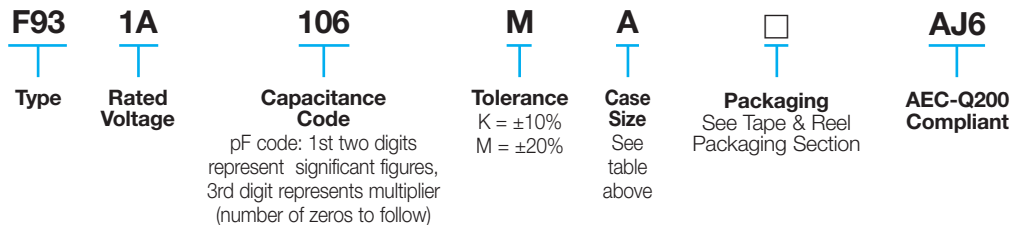

TECHNICAL SPECIFICATIONS

Category Temperature Range:	-55 to +125°C
Rated Temperature:	+85°C
Capacitance Tolerance:	±20%, ±10% at 120Hz
Dissipation Factor:	Refer to next page
ESR 100kHz:	Refer to next page
Leakage Current:	After 1 minute's application of rated voltage, leakage current at 20°C is not more than 0.01CV or 0.5µA, whichever is greater. After 1 minute's application of rated voltage, leakage current at 85°C is not more than 0.1CV or 5µA, whichever is greater. After 1 minute's application of derated voltage, leakage current at 125°C is not more than 0.125CV or 6.3µA, whichever is greater.
Capacitance Change By Temperature	+15% Max. at +125°C +10% Max. at +85°C -10% Max. at -55°C

F93-AJ6 Series



Resin-Molded Chip - Automotive Product Range

CAPACITANCE AND RATED VOLTAGE RANGE (LETTER DENOTES CASE SIZE)

Capacitance		Rated Voltage						
μF	Code	4V (0G)	6.3V (0J)	10V (1A)	16V (1C)	20V (1D)	25V (1E)	35V (1V)
1.0	105				A		A	A
1.5	155				A		A	A
2.2	225				A	A	A	A/B
3.3	335				A	A	A	B
4.7	475			A	A	A/B	A/B	B/C
6.8	685			A	A	A/B		C
10	106		A	A	A/B	A/B	B/C	C
15	156		A	A	A/B	C	C	N
22	226	A	A	A/B	A/B/C	B/C	C/N	N
33	336	A	A	A/B	B/C	C/N	N	
47	476	A	A/B	A/B/C	B*/C/N	C/N	N	
68	686	A	A/B	B/C	C/N			
100	107	A/B	B/C	C/N	C/N			
150	157	B	B/C	N	N			
220	227	B/C	C/N	C*/N				
330	337	C	C*/N	N				
470	477	N	N					
680	687	N	N*					

Available Ratings

*Codes under development – subject to change

F93-AJ6 Series



Resin-Molded Chip - Automotive Product Range

RATINGS & PART NUMBER REFERENCE

AVX Part No.	Case Size	Capacitance (µF)	Rated Voltage (V)	DCL (µA)	DF @ 120Hz (%)	ESR @ 100kHz (Ω)	*1 ΔC/C (%)
4 Volt							
F930G226MAAAJ6	A	22	4	0.9	6	2.5	*
F930G336MAAAJ6	A	33	4	1.3	8	2.5	*
F930G476MAAAJ6	A	47	4	1.9	18	2.5	*
F930G686MAAAJ6	A	68	4	2.7	24	2.5	*
F930G107MAAAJ6	A	100	4	4	30	2.0	*
F930G107MBAAJ6	B	100	4	4	14	0.9	*
F930G157MBAAJ6	B	150	4	6	16	0.7	*
F930G227MBAAJ6	B	220	4	8.8	18	0.7	*
F930G227MCCAJ6	C	220	4	8.8	12	0.7	*
F930G337MCCAJ6	C	330	4	13.2	14	0.7	*
F930G477MNCAJ6	N	470	4	18.8	16	0.3	*
F930G687MNCAJ6	N	680	4	27.2	18	0.3	*
6.3 Volt							
F930J106MAAAJ6	A	10	6.3	0.6	6	3.0	*
F930J156MAAAJ6	A	15	6.3	0.9	6	2.9	*
F930J226MAAAJ6	A	22	6.3	1.4	8	2.5	*
F930J336MAAAJ6	A	33	6.3	2.1	8	2.5	*
F930J476MAAAJ6	A	47	6.3	3	18	2.5	*
F930J476MBAAJ6	B	47	6.3	3	6	1.0	*
F930J686MAAAJ6	A	68	6.3	4.3	20	2.0	*
F930J686MBAAJ6	B	68	6.3	4.3	8	1.0	*
F930J107MBAAJ6	B	100	6.3	6.3	14	0.9	*
F930J107MCCAJ6	C	100	6.3	6.3	8	0.7	*
F930J157MBAAJ6	B	150	6.3	9.5	18	0.9	*
F930J157MCCAJ6	C	150	6.3	9.5	12	0.7	*
F930J227MCCAJ6	C	220	6.3	13.9	14	0.7	*
F930J227MNCAJ6	N	220	6.3	13.9	10	0.5	*
F930J337MNCAJ6	N	330	6.3	20.8	14	0.5	*
F930J477MNCAJ6	N	470	6.3	29.6	16	0.3	*
10 Volt							
F931A475MAAAJ6	A	4.7	10	0.5	6	4.0	*
F931A685MAAAJ6	A	6.8	10	0.7	6	3.5	*
F931A106MAAAJ6	A	10	10	1	6	3.0	*
F931A156MAAAJ6	A	15	10	1.5	8	2.9	*
F931A226MAAAJ6	A	22	10	2.2	12	2.5	*
F931A226MBAAJ6	B	22	10	2.2	6	1.9	*
F931A336MAAAJ6	A	33	10	3.3	18	2.5	*
F931A336MBAAJ6	B	33	10	3.3	8	1.4	*
F931A476MAAAJ6	A	47	10	4.7	40	2.0	*
F931A476MBAAJ6	B	47	10	4.7	8	1.0	*
F931A476MCCAJ6	C	47	10	4.7	6	0.9	*
F931A686MBAAJ6	B	68	10	6.8	12	0.9	±15
F931A686MCCAJ6	C	68	10	6.8	8	0.8	*
F931A107MCCAJ6	C	100	10	10	10	0.7	*
F931A107MNCAJ6	N	100	10	10	8	0.6	*
F931A157MNCAJ6	N	150	10	15	10	0.6	*
F931A227MNCAJ6	N	220	10	22	12	0.5	*
F931A337MNCAJ6	N	330	10	33	18	0.5	*
16 Volt							
F931C105MAAAJ6	A	1	16	0.5	4	7.5	*
F931C155MAAAJ6	A	1.5	16	0.5	4	6.0	*
F931C225MAAAJ6	A	2.2	16	0.5	4	5.0	*
F931C335MAAAJ6	A	3.3	16	0.5	4	4.5	*
F931C475MAAAJ6	A	4.7	16	0.8	6	4.0	*
F931C685MAAAJ6	A	6.8	16	1.1	6	3.5	*
F931C106MAAAJ6	A	10	16	1.6	6	3.0	*

AVX Part No.	Case Size	Capacitance (µF)	Rated Voltage (V)	DCL (µA)	DF @ 120Hz (%)	ESR @ 100kHz (Ω)	*1 ΔC/C (%)
20 Volt							
F931D225MAAAJ6	A	2.2	20	0.5	4	5.0	*
F931D335MAAAJ6	A	3.3	20	0.7	4	4.5	*
F931D475MAAAJ6	A	4.7	20	0.9	6	3.0	*
F931D475MBAAJ6	B	4.7	20	0.9	6	2.8	*
F931D685MAAAJ6	A	6.8	20	1.4	6	3.5	*
F931D685MBAAJ6	B	6.8	20	1.4	6	2.5	*
F931D106MAAAJ6	A	10	20	2	8	3.5	*
F931D106MBAAJ6	B	10	20	2	6	2.1	*
F931D156MCCAJ6	C	15	20	3	6	1.2	*
F931D226MBAAJ6	B	22	20	4.4	8	1.9	*
F931D226MCCAJ6	C	22	20	4.4	8	1.1	*
F931D336MCCAJ6	C	33	20	6.6	8	1.1	*
F931D336MNCAJ6	N	33	20	6.6	6	0.7	*
F931D476MCCAJ6	C	47	20	9.4	10	1.1	*
F931D476MNCAJ6	N	47	20	9.4	8	0.7	*
25 Volt							
F931E105MAAAJ6	A	1	25	0.5	4	7.5	*
F931E155MAAAJ6	A	1.5	25	0.5	4	6.7	*
F931E225MAAAJ6	A	2.2	25	0.6	6	6.3	*
F931E335MAAAJ6	A	3.3	25	0.8	6	6.0	*
F931E475MAAAJ6	A	4.7	25	1.2	8	4.0	*
F931E475MBAAJ6	B	4.7	25	1.2	6	2.8	*
F931E106MBAAJ6	B	10	25	2.5	12	1.9	*
F931E106MCCAJ6	C	10	25	2.5	6	1.5	*
F931E156MCCAJ6	C	15	25	3.8	8	1.2	*
F931E226MCCAJ6	C	22	25	5.5	8	1.1	*
F931E226MNCAJ6	N	22	25	5.5	6	0.7	*
F931E336MNCAJ6	N	33	25	8.3	8	0.7	*
F931E476MNCAJ6	N	47	25	11.8	8	0.7	*
35 Volt							
F931V105MAAAJ6	A	1	35	0.5	4	7.5	*
F931V155MAAAJ6	A	1.5	35	0.5	6	7.5	*
F931V225MAAAJ6	A	2.2	35	0.8	6	7.0	*
F931V225MBAAJ6	B	2.2	35	0.8	4	3.8	*
F931V335MBAAJ6	B	3.3	35	1.2	4	3.5	*
F931V475MBAAJ6	B	4.7	35	1.6	8	3.1	*
F931V475MCCAJ6	C	4.7	35	1.6	6	1.8	*
F931V685MCCAJ6	C	6.8	35	2.4	6	1.8	*
F931V106MCCAJ6	C	10	35	3.5	6	1.6	*
F931V156MNCAJ6	N	15	35	5.3	6	0.7	*
F931V226MNCAJ6	N	22	35	7.7	8	0.7	*

* In case of capacitance tolerance ± 10% type, "K" will be put at 9th digit of type numbering system

1: ΔC/C Marked ""

Item	All Case (%)
Damp Heat	±10
Temperature cycles	±10
Resistance soldering heat	±10
Surge	±10
Endurance	±10
Load Humidity	±10

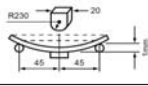

QUALIFICATION TABLE

TEST	F93-AJ6 series (Temperature range -55°C to +125°C)	
	Condition	
Damp Heat (Steady State)	At 40°C, 90 to 95% R.H., 500 hours (No voltage applied) Capacitance Change Refer to page 35 (*1) Dissipation Factor Initial specified value or less Leakage Current Initial specified value or less	
Load Humidity	After 1000 hour's application of rated voltage in series with a 33Ω resistor at 85°C, 85% R.H., capacitors meet the characteristics requirements table below. Capacitance Change Refer to page 35 (*1) Dissipation Factor Initial specified value or less Leakage Current 125% or less than the initial specified value	
Temperature Cycles	At -55°C / +125°C, 30 minutes each, 1000 cycles Capacitance Change Refer to page 35 (*1) Dissipation Factor Initial specified value or less Leakage Current Initial specified value or less	
Resistance to Soldering Heat	10 seconds reflow at 260°C, 10 seconds immersion at 260°C. Capacitance Change Refer to page 35 (*1) Dissipation Factor Initial specified value or less Leakage Current Initial specified value or less	
Surge	After application of surge voltage in series with a 33Ω resistor at the rate of 30 seconds ON, 30 seconds OFF, for 1000 successive test cycles at 85°C, capacitors shall meet the characteristic requirements in the table above. Capacitance Change Refer to page 35 (*1) Dissipation Factor Initial specified value or less Leakage Current Initial specified value or less	
Endurance	After 2000 hours' application of rated voltage in series with a 3Ω resistor at 85°C, or derated voltage in series with a 3Ω resistor at 125°C, capacitors shall meet the characteristic requirements in the table above. Capacitance Change Refer to page 35 (*1) Dissipation Factor Initial specified value or less Leakage Current Initial specified value or less	
Shear Test	After applying the pressure load of 17.7N for 60 seconds horizontally to the center of capacitor side body which has no electrode and has been soldered beforehand on a substrate, there shall be found neither exfoliation nor its sign at the terminal electrode.	
Terminal Strength	Keeping a capacitor surface-mounted on a substrate upside down and supporting the substrate at both of the opposite bottom points 45mm apart from the center of capacitor, the pressure strength is applied with a specified jig at the center of the substrate so that substrate may bend by 1mm as illustrated. Then, there shall be found no remarkable abnormality on the capacitor terminals.	
Failure Rate	1% per 1000 hours at 85°C, V_R with 0.1Ω/V series impedance, 60% confidence level.	

TLJ Series



Tantalum Solid Electrolytic Chip Capacitors High CV Consumer Series



FEATURES

- High Volumetric Efficiency
- 3x reflow 260°C compatible
- 14 case sizes available including low profile codes
- Environmentally friendly
- Consumer applications (e.g. mobiles phones, PDA etc.)
- CV range: 10-1500µF / 2.5-20V



LEAD-FREE
LEAD-FREE COMPATIBLE
COMPONENT

APPLICATIONS

- Mobile phones
- MP3/4 players

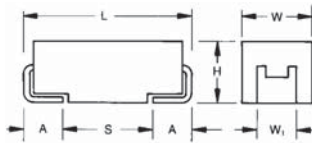

MARKING

A, B, F, G, H, K, S, T, V, W,
Y CASE

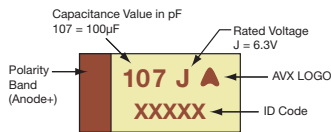

N, P, R CASE

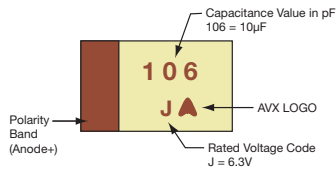

CASE DIMENSIONS: millimeters (inches)

Code	EIA Code	EIA Metric	L±0.20 (0.008)	W+0.20 (0.008) -0.10 (0.004)	H+0.20 (0.008) -0.10 (0.004)	W ₁ ±0.20 (0.008)	A+0.30 (0.012) -0.20 (0.008)	S Min.
A	1206	3216-18	3.20 (0.126)	1.60 (0.063)	1.60 (0.063)	1.20 (0.047)	0.80 (0.031)	1.10 (0.043)
B	1210	3528-21	3.50 (0.138)	2.80 (0.110)	1.90 (0.075)	2.20 (0.087)	0.80 (0.031)	1.40 (0.055)
F	2312	6032-20	6.00 (0.236)	3.20 (0.126)	2.00 (0.079) max.	2.20 (0.087)	1.30 (0.051)	2.90 (0.114)
G	1206	3216-15	3.20 (0.126)	1.60 (0.063)	1.50 (0.059) max.	1.20 (0.047)	0.80 (0.031)	1.10 (0.043)
H	1210	3528-15	3.50 (0.138)	2.80 (0.110)	1.50 (0.059) max.	2.20 (0.087)	0.80 (0.031)	1.40 (0.055)
K	1206	3216-10	3.20 (0.126)	1.60 (0.063)	1.00 (0.039) max.	1.20 (0.047)	0.80 (0.031)	1.10 (0.043)
N	0805	2012-10	2.05 (0.081)	1.30 (0.051)	1.00 (0.039) max.	1.00 (0.039)	0.50 (0.020)	0.85 (0.033)
P	0805	2012-15	2.05 (0.081)	1.35 (0.053)	1.50 (0.059) max.	1.00±0.10 (0.039±0.004)	0.50 (0.020)	0.85 (0.033)
R	0805	2012-12	2.05 (0.081)	1.30 (0.051)	1.20 (0.047) max.	1.00±0.10 (0.039±0.004)	0.50 (0.020)	0.85 (0.033)
S	1206	3216-12	3.20 (0.126)	1.60 (0.063)	1.20 (0.047) max.	1.20 (0.047)	0.80 (0.031)	1.10 (0.043)
T	1210	3528-12	3.50 (0.138)	2.80 (0.110)	1.20 (0.047) max.	2.20 (0.087)	0.80 (0.031)	1.40 (0.033)
V	2924	7361-38	7.30 (0.287)	6.10 (0.240)	3.55 (0.140)	3.10 (0.120)	1.30 (0.051)	4.40 (0.173)
W	2312	6032-15	6.00 (0.236)	3.20 (0.126)	1.50 (0.059) max.	2.20 (0.087)	1.30 (0.051)	2.90 (0.114)
Y	2917	7343-20	7.30 (0.287)	4.30 (0.169)	2.00 (0.079) max.	2.40 (0.094)	1.30 (0.051)	4.40 (0.173)

W1 dimension applies to the termination width for A dimensional area only.

HOW TO ORDER

TLJ

Type

W

Case Size
See table above

157

Capacitance Code
pF code: 1st two digits represent significant figures, 3rd digit represents multiplier (number of zeros to follow)

M

Tolerance
M = ±20%

010

Rated DC Voltage
002 = 2.5Vdc
004 = 4Vdc
006 = 6.3Vdc
010 = 10Vdc
016 = 16Vdc
020 = 20Vdc

R

Packaging
R = Pure Tin 7" Reel
S = Pure Tin 13" Reel

0200

ESR in mΩ

TECHNICAL SPECIFICATIONS

Technical Data: All technical data relate to an ambient temperature of +25°C

Capacitance Range: 10 µF to 1500 µF

Capacitance Tolerance: ±20%

Rated Voltage (V _R)	-55°C ≤ +40°C:	2.5	4	6.3	10	16	20
Category Voltage (V _C)	at 85°C:	1.3	2	3.2	5	8	10
Category Voltage (V _C)	at 125°C:	0.5	0.8	1.3	2	3.2	4

Temperature Range: -55°C to +125°C with category voltage

Reliability: 0.2% per 1000 hours at 85°C, 0.5xV_R with 0.1Ω/V series impedance with 60% confidence level

TLJ Series



Tantalum Solid Electrolytic Chip Capacitors High CV Consumer Series

CAPACITANCE AND RATED VOLTAGE RANGE (LETTER DENOTES CASE SIZE)

Capacitance		Rated Voltage DC to 40°C / 0.5DC to 85°C / 0.2DC to 125°C					
µF	Code	2.5V (e)	4V (G)	6.3V (J)	10V (A)	16V (C)	20V (D)
6.8	685						
10	106				N(2500) R(2000,3000)	S(2200)	T(1000)
15	156				R(2000)		
22	226			N(5400)/R(3500)	K(1800)/N(3800) R(3800)	T(1000)	
33	336		N(8000)/R(3000)	K(1700)/N(8000) P(3000)/R(3000)	K(1500)/N(9600) P(3500) R(3500)/S(1500)	T(1000)	
47	476		K(1500)/N(4000) P(3000)/R(3000)	K(1500)/N(8300) P(700,900,1800,2500) R(3200)/S(1500)	A(600)/G(1500) P(3200)/R(3200) S(1500)/T(600)		
68	686		K(1200)/N(8000) P(3000) R(2900)/S(1500)	A(500)/G(800) K(2000) S(1500)/T(600)	A(1500)		
100	107		A(500)/G(800) K(2000)/P(2700) S(1400)	A(500,800)/G(800) K(2000) P(5400)/T(800)	A(1400) H(900)/T(900)		
150	157		A(800)/T(800)	A(900)/G(2500)* H(900)/T(1200)	B(500) W(150,200)		
220	227	T(1100)	A(1100)/G(3000) H(900)/T(1100)	B(500)/T(2000) W(200)	F(300)		
330	337		T(2700)/W(200)	F(300)			
470	477						
680	687			Y(100,150)			
1000	108						
1500	158			V(100)			

Available Ratings, (ESR ratings in mOhms in brackets)

Engineering samples - please contact manufacturer

*Codes under development - subject to change

Note: Voltage ratings are minimum values. AVX reserves the right to supply higher ratings in the same case size, to the same reliability standards.

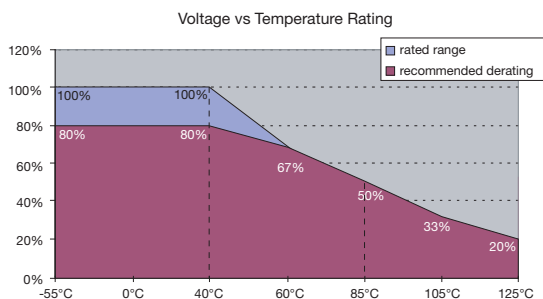

TLJ Series



Tantalum Solid Electrolytic Chip Capacitors High CV Consumer Series

RATINGS & PART NUMBER REFERENCE

AVX Part No.	Case Size	Capacitance (μF)	Rated Voltage (V)	Rated Temperature (°C)	Category Voltage (V)	Category Temperature (°C)	Maximum Surge Current (A)	DCL Max. (μA)	ESR Max. @ 100kHz (mΩ)	MSL	100kHz RMS Current (mA)			Product Category
											25°C	85°C	125°C	
2.5 Volt @ 40°C														
TLJT227M002#1200	T	220	2.5	40	0.5	125	0.8	5.5	1100	3	270	243	108	2
4 Volt @ 40°C														
TLJN336M004#8000	N	33	4	40	0.8	125	0.2	1.3	8000	3	79	71	32	1
TLJR336M004#3000	R	33	4	40	0.8	125	0.6	1.3	3000	3	135	122	54	2
TLJK476M004#1500	K	47	4	40	0.8	125	1.0	1.9	1500	3	208	187	83	2
TLJN476M004#4000	N	47	4	40	0.8	125	0.6	1.9	4000	3	112	101	45	1
TLJP476M004#3000	P	47	4	40	0.8	125	0.6	1.9	3000	3	141	127	57	2
TLJR476M004#3000	R	47	4	40	0.8	125	0.6	1.9	3000	3	135	122	54	2
TLJK686M004#1200	K	68	4	40	0.8	125	1.2	2.7	1200	3	233	209	93	2
TLJN686M004#8000	N	68	4	40	0.8	125	0.2	5.4	8000	3	79	71	32	1
TLJP686M004#3000	P	68	4	40	0.8	125	1.2	2.7	3000	3	141	127	57	2
TLJR686M004#2900	R	68	4	40	0.8	125	0.6	2.7	2900	3	138	124	55	2
TLJS686M004#1500	S	68	4	40	0.8	125	1.0	2.7	1500	3	208	187	83	2
TLJA107M004#0500	A	100	4	40	0.8	125	2.1	4.0	500	3	387	349	155	1
TLJG107M004#0800	G	100	4	40	0.8	125	1.6	4.0	800	3	296	266	118	2
TLJK107M004#2000	K	100	4	40	0.8	125	0.8	8.0	2000	3	180	162	72	2
TLJP107M004#2700	P	100	4	40	0.8	125	0.6	8.0	2700	3	149	134	60	2
TLJS107M004#1400	S	100	4	40	0.8	125	1.1	4.0	1400	3	215	194	86	2
TLJA157M004#0800	A	150	4	40	0.8	125	1.6	6.0	800	3	306	276	122	2
TLJT157M004#0800	T	150	4	40	0.8	125	1.6	6.0	800	3	316	285	126	2
TLJA227M004#1100	A	220	4	40	0.8	125	1.3	17.6	1100	3	261	235	104	2
TLJG227M004#3000	G	220	4	40	0.8	125	0.6	17.6	3000	3	153	137	61	2
TLJH227M004#0900	H	220	4	40	0.8	125	1.5	8.8	900	3	298	268	119	2
TLJT227M004#1100	T	220	4	40	0.8	125	1.3	17.6	1100	3	270	243	108	2
TLJT337M004#2700	T	330	4	40	0.8	125	0.6	26.4	2700	3	172	155	69	2
TLJW337M004#0200	W	330	4	40	0.8	125	3.1	13.2	200	3	671	604	268	1
6.3 Volt @ 40°C														
TLJN226M006#5400	N	22	6.3	40	1.3	125	0.5	1.3	5400	3	96	87	38	1
TLJR226M006#3500	R	22	6.3	40	1.3	125	0.8	1.3	3500	3	125	113	50	2
TLJK336M006#1700	K	33	6.3	40	1.3	125	1.5	2.0	1700	3	196	176	78	2
TLJN336M006#8000	N	33	6.3	40	1.3	125	0.4	2.0	8000	3	79	71	32	1
TLJP336M006#3000	P	33	6.3	40	1.3	125	0.9	2.0	3000	3	141	127	57	1
TLJR336M006#3000	R	33	6.3	40	1.3	125	0.9	2.0	3000	3	135	122	54	2
TLJK476M006#1500	K	47	6.3	40	1.3	125	1.6	2.8	1500	3	208	187	83	2
TLJN476M006#8300	N	47	6.3	40	1.3	125	0.4	5.6	8300	3	78	70	31	1
TLJP476M006#0700	P	47	6.3	40	1.3	125	2.7	2.8	700	3	293	263	117	2
TLJP476M006#0900	P	47	6.3	40	1.3	125	2.3	2.8	900	3	258	232	103	2
TLJP476M006#1800	P	47	6.3	40	1.3	125	1.4	2.8	1800	3	183	164	73	2
TLJP476M006#2500	P	47	6.3	40	1.3	125	1.1	2.8	2500	3	155	139	62	2
TLJR476M006#3200	R	47	6.3	40	1.3	125	0.9	2.8	3200	3	131	118	52	2
TLJS476M006#1500	S	47	6.3	40	1.3	125	1.6	2.8	1500	3	208	187	83	2
TLJA686M006#0500	A	68	6.3	40	1.3	125	3.3	4.1	500	3	387	349	155	1
TLJG686M006#0800	G	68	6.3	40	1.3	125	1.9	4.1	800	3	296	266	118	2
TLJK686M006#2000	K	68	6.3	40	1.3	125	1.3	8.16	2000	3	180	162	72	2
TLJS686M006#1500	S	68	6.3	40	1.3	125	1.6	4.1	1500	3	208	187	83	2
TLJT686M006#0600	T	68	6.3	40	1.3	125	3.0	4.1	600	3	365	329	146	1
TLJA107M006#0500	A	100	6.3	40	1.3	125	3.3	6.0	500	3	387	349	155	2
TLJA107M006#0800	A	100	6.3	40	1.3	125	2.5	6.0	800	3	306	276	122	2
TLJG107M006#0800	G	100	6.3	40	1.3	125	2.5	6.0	800	3	296	266	118	2
TLJK107M006#2000	K	100	6.3	40	1.3	125	1.3	12.0	2000	3	180	162	72	2
TLJP107M006#5400	P	100	6.3	40	1.3	125	0.5	12.0	5400	3	105	95	42	2
TLJT107M006#0800	T	100	6.3	40	1.3	125	2.5	6.0	800	3	316	285	126	2
TLJA157M006#0900	A	150	6.3	40	1.3	125	2.3	9.0	900	3	289	260	115	2
TLJH157M006#0900	H	150	6.3	40	1.3	125	2.3	9.0	900	3	298	268	119	2
TLJT157M006#1200	T	150	6.3	40	1.3	125	1.9	9.0	1200	3	258	232	103	2
TLJB227M006#0500	B	220	6.3	40	1.3	125	3.3	13.2	500	3	412	371	165	1
TLJT227M006#2000	T	220	6.3	40	1.3	125	1.3	26.4	2000	3	200	180	80	2
TLJW227M006#0200	W	220	6.3	40	1.3	125	4.8	13.2	200	3	671	604	268	1
TLJF337M006#0300	F	330	6.3	40	1.3	125	4.2	19.8	300	3	577	520	231	1
TLJY687M006#0100	Y	680	6.3	40	1.3	125	5.7	40.8	100	3	1118	1006	447	1
TLJY687M006#0150	Y	680	6.3	40	1.3	125	5.7	40.8	150	3	913	822	365	1
TLJV158M006#0100	V	1500	6.3	40	1.3	125	5.7	90	100	3	1581	1423	632	1

TLJ Series



Tantalum Solid Electrolytic Chip Capacitors High CV Consumer Series

RATINGS & PART NUMBER REFERENCE

AVX Part No.	Case Size	Capacitance (µF)	Rated Voltage (V)	Rated Temperature (°C)	Category Voltage (V)	Category Temperature (°C)	Maximum Surge Current (A)	DCL Max. (µA)	ESR Max. @ 100kHz (mΩ)	MSL	100kHz RMS Current (mA)			Product Category
											25°C	85°C	125°C	
10 Volt @ 40°C														
TLJN106M010#2500	N	10	10	40	2	125	1.7	1.0	2500	3	141	127	57	1
TLJR106M010#2000	R	10	10	40	2	125	2.0	1.0	2000	3	166	149	66	1
TLJR106M010#3000	R	10	10	40	2	125	1.4	1.0	3000	3	135	122	54	1
TLJR156M010#2000	R	15	10	40	2	125	2.0	1.5	2000	3	166	149	66	1
TLJK226M010#1800	K	22	10	40	2	125	2.2	2.2	1800	3	167	150	67	2
TLJN226M010#3800	N	22	10	40	2	125	1.2	2.2	3800	3	115	103	46	1
TLJR226M010#3800	R	22	10	40	2	125	1.2	2.2	3800	3	120	108	48	2
TLJK336M010#1500	K	33	10	40	2	125	2.6	3.3	1500	3	208	187	83	2
TLJN336M010#9600	N	33	10	40	2	125	0.5	6.6	9600	3	72	65	29	1
TLJP336M010#3500	P	33	10	40	2	125	1.3	3.3	3500	3	131	118	52	2
TLJR336M010#3500	R	33	10	40	2	125	1.3	3.3	3500	3	125	113	50	2
TLJS336M010#1500	S	33	10	40	2	125	2.6	3.3	1500	3	208	187	83	2
TLJA476M010#0600	A	47	10	40	2	125	4.8	4.7	600	3	354	318	141	1
TLJG476M010#1500	G	47	10	40	2	125	2.6	4.7	1500	3	216	194	86	2
TLJP476M010#3200	P	47	10	40	2	125	1.4	4.7	3200	3	137	123	55	2
TLJR476M010#3200	R	47	10	40	2	125	1.4	9.4	3200	3	131	118	52	2
TLJS476M010#1500	S	47	10	40	2	125	2.6	4.7	1500	3	208	187	83	2
TLJT476M010#0600	T	47	10	40	2	125	4.8	4.7	600	3	365	329	146	1
TLJA686M010#1500	A	68	10	40	2	125	2.6	6.8	1500	3	224	201	89	2
TLJA107M010#1400	A	100	10	40	2	125	2.7	10.0	1400	3	231	208	93	2
TLJH107M010#0900	H	100	10	40	2	125	3.7	10.0	900	3	298	268	119	2
TLJT107M010#0900	T	100	10	40	2	125	3.7	10.0	900	3	298	268	119	2
TLJB157M010#0500	B	150	10	40	2	125	5.3	15.0	500	3	412	371	165	1
TLJW157M010#0150	W	150	10	40	2	125	8.3	15.0	150	3	775	697	310	1
TLJW157M010#0200	W	150	10	40	2	125	7.7	15.0	200	3	671	604	268	1
TLJF227M010#0300	F	220	10	40	2	125	6.7	22.0	300	3	577	520	231	1
16 Volt @ 40°C														
TLJS106M016#2200	S	10	16	40	3.2	125	3.0	1.6	2200	3	172	155	69	1
TLJT226M016#1000	T	22	16	40	3.2	125	5.5	3.5	1000	3	283	255	113	1
TLJT336M016#1000	T	33	16	40	3.2	125	5.5	5.3	1000	3	283	255	113	1
20 Volt @ 40°C														
TLJT106M020#1000	T	10	20	40	4	125	6.9	2.0	1000	3	283	255	113	1

Moisture Sensitivity Level (MSL) is defined according to J-STD-020.

All technical data relates to an ambient temperature of +25°C. Capacitance is measured at 120Hz, 0.5V RMS with a maximum DC bias of 2.2 volts. DCL is measured at rated voltage after 5 minutes.

ESR allowed to move up to 1.25 times catalogue limit post mounting

DCL allowed to move up to 2.00 times catalogue limit post mounting

For typical weight and composition see page 222.

NOTE: AVX reserves the right to supply a higher voltage rating or tighter tolerance part in the same case size, to the same reliability standards.

Tantalum Solid Electrolytic Chip Capacitors High CV Consumer Series

QUALIFICATION TABLE – CATEGORY 1

TEST	TLJ series (Temperature range -55°C to +125°C)									
	Condition			Characteristics						
Endurance	Determine after application of rated voltage for 2000 +48/-0 hours at 40±2°C and then leaving 1-2 hours at room temperature. Also determine of 85°C temperature, category voltage for 2000 +48/-0 hours and then leaving 1-2 hours at room temperature. Power supply impedance to be ≤0.1Ω/V.			Visual examination	no visible damage					
				DCL	2 x initial limit					
				ΔC/C	within ±10% of initial value					
				ESR	1.25 x initial limit					
Humidity	Determine after storage without applied voltage at 65±2°C and 90-95% relative humidity for 500hrs and then recovery 1-2 hours at room temperature			Visual examination	no visible damage					
				DCL	2 x initial limit					
				ΔC/C	within ±10% of initial value					
				ESR	1.25 x initial limit					
Temperature Stability	Step	Temperature°C	Duration(min)							
	1	+20±2	15	+20°C	-55°C	+20°C	+85°C	+125°C	+20°C	
	2	-55+0/-3	15	DCL	2 x IL*	n/a	2 x IL*	20 x IL*	25 x IL*	IL*
	3	+20±2	15							
	4	+85+3/-0	15	ΔC/C	n/a	+0/-20%	±5%	+20/-0%	+25/-0%	±5%
	5	+125+3/-0	15	ESR	1.25 x IL*	2.5 x IL*	1.25 x IL*	1.25 x IL*	1.25 x IL*	1.25 x IL*
	6	+20±2	15							
Surge Voltage	Test temperature: 40°C+3/0°C Test voltage: 1.3 x rated voltage Series protection resistance 1000±100Ω Discharge resistance: 1000Ω Number of cycles: 1000x Cycle duration: 6 min; 30 sec charge, 5 min 30 sec discharge			Visual examination	no visible damage					
				DCL	2 x initial limit					
				ΔC/C	within ±5% of initial value					
				ESR	1.25 x initial limit					

*Initial Limit

QUALIFICATION TABLE – CATEGORY 2

TEST	TLJ series (Temperature range -55°C to +125°C)									
	Condition			Characteristics						
Endurance	Determine after application of rated voltage for 2000 +48/-0 hours at 40±2°C and then leaving 1-2 hours at room temperature. Also determine of 85°C temperature, category voltage for 2000 +48/-0 hours and then leaving 1-2 hours at room temperature. Power supply impedance to be ≤0.1Ω/V.			Visual examination	no visible damage					
				DCL	2 x initial limit					
				ΔC/C	within +5/-30% of initial value					
				ESR	1.25 x initial limit					
Humidity	Determine after storage without applied voltage at 65±2°C and 90-95% relative humidity for 500hrs and then recovery 1-2 hours at room temperature			Visual examination	no visible damage					
				DCL	2 x initial limit					
				ΔC/C	within ±10% of initial value					
				ESR	1.25 x initial limit					
Temperature Stability	Step	Temperature°C	Duration(min)							
	1	+20±2	15	+20°C	-55°C	+20°C	+85°C	+125°C	+20°C	
	2	-55+0/-3	15	DCL	2 x IL*	n/a	2 x IL*	20 x IL*	25 x IL*	2 x IL*
	3	+20±2	15							
	4	+85+3/-0	15	ΔC/C	n/a	+5/-20%	±10%	+20/-0%	+25/-0%	±10%
	5	+125+3/-0	15	ESR	1.25 x IL*	2.5 x IL*	1.25 x IL*	1.25 x IL*	1.25 x IL*	1.25 x IL*
	6	+20±2	15							
Surge Voltage	Test temperature: 40°C+3/0°C Test voltage: 1.3 x rated voltage Series protection resistance 1000±100Ω Discharge resistance: 1000Ω Number of cycles: 1000x Cycle duration: 6 min; 30 sec charge, 5 min 30 sec discharge			Visual examination	no visible damage					
				DCL	2 x initial limit					
				ΔC/C	within ±5% of initial value					
				ESR	1.25 x initial limit					

*Initial Limit

TLN Series



Tantalum Solid Electrolytic Chip Capacitors Undertab Series



FEATURES

- Undertab terminations layout:
 - High Volumetric Efficiency
 - High PCB assembly density
 - High capacitance in smaller dimensions
- 3x reflow 260°C compatible
- Consumer applications (e.g. PCMCIA/USB wireless express cards, mobiles, MP3 etc.)
- 6 case sizes available
- CV range: 47-220µF / 4-10V



APPLICATIONS

- Mobile phones
- Tablets
- MP3/4players

CASE DIMENSIONS: millimeters (inches)

Code	EIA Code	EIA Metric	L±0.20 (0.008)	W+0.20 (0.008) -0.10 (0.004)	H max.	W _P ±0.10 (0.004)	W _N ±0.10 (0.004)	A _P ±0.10 (0.004)	A _N ±0.10 (0.004)	S Min.
M	0805	2012-09	2.05 (0.081)	1.30 (0.051)	0.90 (0.035)	1.00 (0.039)	1.00 (0.039)	0.85 (0.033)	0.85 (0.033)	0.40 (0.016)
N	0805	2012-10	2.05 (0.081)	1.30 (0.051)	1.00 (0.039)	1.00 (0.039)	1.00 (0.039)	0.85 (0.033)	0.85 (0.033)	0.40 (0.016)
K	1206	3216-10	3.20 (0.126)	1.60 (0.063)	1.00 (0.039)	1.30 (0.051)	1.30 (0.051)	1.15 (0.045)	1.15 (0.045)	0.90 (0.035)
S	1206	3216-12	3.20 (0.126)	1.60 (0.063)	1.20 (0.047)	1.30 (0.051)	1.30 (0.051)	1.15 (0.045)	1.15 (0.045)	0.90 (0.035)
L	1210	3528-10	3.50 (0.138)	2.80 (0.110)	1.00 (0.039)	2.50 (0.098)	2.10 (0.083)	1.15 (0.045)	1.35 (0.053)	1.00 (0.039)
T	1210	3528-12	3.50 (0.138)	2.80 (0.110)	1.20 (0.047)	2.50 (0.098)	2.10 (0.083)	1.15 (0.045)	1.35 (0.053)	1.00 (0.039)

MARKING

K, L, S, T, CASE

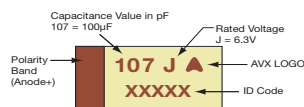

M, N CASE

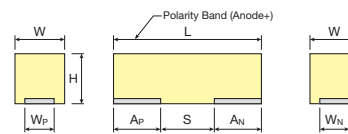
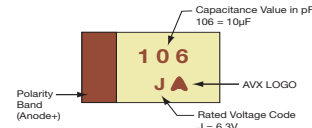

HOW TO ORDER

TLN

Type

S

Case Size
See table above

227

Capacitance Code
pF code: 1st two digits represent significant figures, 3rd digit represents multiplier (number of zeros to follow)

M

Tolerance
M = ±20%

004

Rated DC Voltage
004 = 4Vdc
006 = 6.3Vdc
010 = 10Vdc

R

Packaging
R = Pure Tin 7" Reel
S = Pure Tin 13" Reel

3000

ESR in mΩ

TECHNICAL SPECIFICATIONS

Technical Data:

All technical data relate to an ambient temperature of +25°C

Capacitance Range: 47 µF to 1000 µF

Capacitance Tolerance: ±20%

Rated Voltage (V _R)	-55°C ≤ +40°C:	4	6.3	10
---------------------------------	----------------	---	-----	----

Category Voltage (V _C)	at 85°C:	2	3.2	5
------------------------------------	----------	---	-----	---

Category Voltage (V _C)	at 125°C:	0.8	1.3	2
------------------------------------	-----------	-----	-----	---

Temperature Range: -55°C to +125°C with category voltage

Reliability: 0.2% per 1000 hours at 85°C, 0.5xV_R with 0.1Ω/V series impedance with 60% confidence level

TLN Series



Tantalum Solid Electrolytic Chip Capacitors Undertab Series

CAPACITANCE AND RATED VOLTAGE RANGE (LETTER DENOTES CASE SIZE)

Capacitance		Rated Voltage DC to 40°C / 0.5DC to 85°C/ 0.2DC to 125°C		
µF	Code	4V (G)	6.3V (J)	10V (A)
33	336			
47	476			K(1500)/M(6000)/N(6000)
68	686	N(3000)*	K(5400)	K(5400)/S(6000)
100	107	N(5200)	K(2000,5400)/S(5400)	K(2500)/L(7200)* S(2500)
150	157	K(2500)/S(2500)	K(2500)/L(5400)* S(2500)	H(6000)/(1300) S(7200)*T(1500)
220	227	K(2500)/L(1300) S(3000)/T(1500)	K*/L(1000) S(8300)*T(1500)	G(7200)*H(6000)* T(1300)
330	337	G(4000)*K* L(4000)*S(5200)*	G(5400)*H(3000)*	H(7200)*T(9600)*
470	477	G(5200)*H(3000)* T(4000)*	H(5400)*T(8300)*	H(9600)*
680	687	H(4000)*T(5200)*	H(8300)*	
1000	108	H(5200)*	Y(150)*	

Available Ratings, (ESR ratings in mOhms in brackets)

Engineering samples - please contact manufacturer

*Codes under development - subject to change

Note: Voltage ratings are minimum values. AVX reserves the right to supply higher ratings in the same case size, to the same reliability standards.

RATINGS & PART NUMBER REFERENCE

AVX Part No.	Case Size	Capacitance (µF)	Rated Voltage (V)	Rated Temperature (°C)	Category Voltage (V)	Category Temperature (°C)	Maximum Surge Current (A)	DCL Max. (µA)	ESR Max. @ 100kHz (mΩ)	MSL	100kHz RMS Current (mA)		
											25°C	85°C	125°C
4 Volt @ 40°C													
TLNN107M004#5200	N	100	4	40	0.8	125	0.4	20	5200	3	88	79	35
TLNK157M004#2500	K	150	4	40	0.8	125	0.7	12	2500	3	148	133	59
TLNS157M004#2500	S	150	4	40	0.8	125	0.7	12	2500	3	148	133	59
TLNK227M004#2500	K	220	4	40	0.8	125	0.7	44	2500	3	148	133	59
TLNL227M004#1300	L	220	4	40	0.8	125	1.1	17.6	1300	3	215	193	86
TLNS227M004#3000	S	220	4	40	0.8	125	0.6	17.6	3000	3	135	122	54
TLNT227M004#1500	T	220	4	40	0.8	125	1.0	17.6	1500	3	216	194	86
6.3 Volt @ 40°C													
TLNK686M006#5400	K	68	6.3	40	1.3	125	0.5	4.1	5400	3	101	91	40
TLNK107M006#2000	K	100	6.3	40	1.3	125	1.3	12	2000	3	166	149	66
TLNK107M006#5400	K	100	6.3	40	1.3	125	0.5	6	5400	3	101	91	40
TLNS107M006#5400	S	100	6.3	40	1.3	125	0.5	6	5400	3	101	91	40
TLNK157M006#2500	K	150	6.3	40	1.3	125	1.1	18	2500	3	148	133	59
TLNS157M006#2500	S	150	6.3	40	1.3	125	1.1	18	2500	3	148	133	59
TLNL227M006#1000	L	220	6.3	40	1.3	125	2.2	26.4	1000	3	245	220	98
TLNT227M006#1500	T	220	6.3	40	1.3	125	1.6	26.4	1500	3	216	194	86
TLNY108M006#0150	Y	1000	6.3	40	1.3	125	5.3	63	150	3	876	788	350
10 Volt @ 40°C													
TLNK476M010#1500	K	47	10	40	2	125	2.6	4.7	1500	3	191	172	77
TLNM476M010#6000	M	47	10	40	2	125	0.8	9.4	6000	3	82	73	33
TLNN476M010#6000	N	47	10	40	2	125	0.8	9.4	6000	3	82	73	33
TLNK686M010#5400	K	68	10	40	2	125	0.9	6.8	5400	3	101	91	40
TLNS686M010#6000	S	68	10	40	2	125	0.8	6.8	6000	3	96	86	38
TLNK107M010#2500	K	100	10	40	2	125	1.7	20	2500	3	148	133	59
TLNS107M010#2500	S	100	10	40	2	125	1.7	10	2500	3	148	133	59
TLNH157M010#6000	H	150	10	40	2	125	0.8	30	6000	3	108	97	43
TLNL157M010#1300	L	150	10	40	2	125	2.9	30	1300	3	215	193	86
TLNT157M010#1500	T	150	10	40	2	125	2.6	30	1500	3	216	194	86
TLNT227M010#1300	T	220	10	40	2	125	2.9	44	1300	3	232	209	93

Moisture Sensitivity Level (MSL) is defined according to J-STD-020.

All technical data relates to an ambient temperature of +25°C. Capacitance is measured at 120Hz, 0.5V RMS with a maximum DC bias of 2.2 volts.

DCL is measured at rated voltage after 5 minutes.

ESR allowed to move up to 1.25 times catalogue limit post mounting

DCL allowed to move up to 2.00 times catalogue limit post mounting

For typical weight and composition see page 222.

NOTE: AVX reserves the right to supply a higher voltage rating or tighter tolerance part in the same case size, to the same reliability standards.

TLN Series



Tantalum Solid Electrolytic Chip Capacitors Undertab Series

QUALIFICATION TABLE

TEST	TLN series (Temperature range -55°C to +125°C)										
	Condition			Characteristics							
Endurance	Determine after application of rated voltage for 2000 +48/-0 hours at 40±2°C and then leaving 1-2 hours at room temperature. Also determine of 85°C temperature, category voltage for 2000 +48/-0 hours and then leaving 1-2 hours at room temperature. Power supply impedance to be ≤0.1Ω/V.			Visual examination	no visible damage						
				DCL	2 x initial limit						
				ΔC/C	within +5/-30% of initial value						
				ESR	1.25 x initial limit						
Humidity	Determine after storage without applied voltage at 65±2°C and 90-95% relative humidity for 500 hours and then recovery 1-2 hours at room temperature.			Visual examination	no visible damage						
				DCL	2 x initial limit						
				ΔC/C	within ±10% of initial value						
				ESR	1.25 x initial limit						
Temperature Stability	Step	Temperature°C	Duration(min)		+20°C	-55°C	+20°C	+85°C	+125°C	+20°C	
	1	+20±2	15	DCL	2 x IL*	n/a	2 x IL*	20 x IL*	25 x IL*	2 x IL*	
	2	-55+0/-3	15		ΔC/C	n/a	+5/-20%	±10%	+20/-0%	+25/-0%	±10%
	3	+20±2	15			ESR	1.25 x IL*	2.5 x IL*	1.25 x IL*	1.25 x IL*	1.25 x IL*
	4	+85+3/-0	15								
	5	+125+3/-0	15								
6	+20±2	15									
Surge Voltage	Test temperature: 40°C+3/0°C Test voltage: 1.3 x rated voltage Series protection resistance 1000±100Ω Discharge resistance: 1000Ω Number of cycles: 1000x Cycle duration: 6 min; 30 sec charge, 5 min 30 sec discharge			Visual examination	no visible damage						
				DCL	2 x initial limit						
				ΔC/C	within ±5% of initial value						
				ESR	1.25 x initial limit						

*Initial Limit

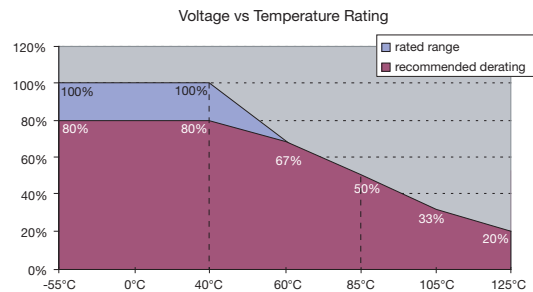

TLN PulseCap™ Series



High Capacitance Tantalum Solid Electrolytic Chip Capacitors Undertab Series



FEATURES

- Large case size for maximum capacitance
- 3x reflow 260°C compatible
- Low profile solution
- Consumer applications (e.g. PCMCIA/USB wireless express cards etc.)
- CV range: 1000-3300µF / 4-10V
- 2 case sizes available

APPLICATIONS

- Data transfer modems
- SSD backup circuits



LEAD-FREE
LEAD-FREE COMPATIBLE
COMPONENT



RoHS
COMPLIANT

CASE DIMENSIONS: millimeters (inches)

Code	EIA Code	EIA Metric	L±0.20 (0.008)	W+0.20 (0.008) -0.10 (0.004)	H max.	W _P ±0.10 (0.004)	W _N ±0.10 (0.004)	A _P ±0.10 (0.004)	A _N ±0.10 (0.004)	S Min.
4	2924	7361-20	7.30 (0.287)	6.10 (0.240)	2.00 (0.079)	4.75 (0.187)	4.75 (0.187)	2.00 (0.079)	3.20 (0.126)	2.10 (0.083)
6	5831	14878-20	14.80 (0.583)	7.80 (0.307)	2.00 (0.079)	5.50 (0.217)	5.50 (0.217)	2.45 (0.096)	2.45 (0.096)	9.90 (0.390)

MARKING

4, 6 CASE

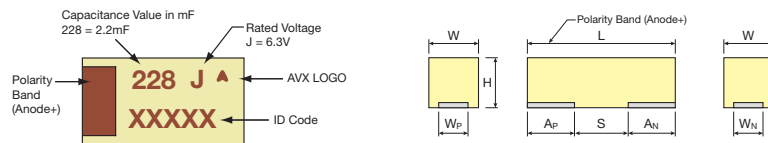

HOW TO ORDER

TLN

Type

6

Case Size
See table above

228

Capacitance Code
pF code: 1st two digits represent significant figures, 3rd digit represents multiplier

M

Tolerance
M = ±20%

006

Rated DC Voltage
004 = 4Vdc
006 = 6.3Vdc
010 = 10Vdc

R

Packaging
R = Pure Tin 7" Reel

0055

ESR in mΩ

TECHNICAL SPECIFICATIONS

Technical Data:	All technical data relate to an ambient temperature of +25°C				
Capacitance Range:	1000 µF to 3300 µF				
Capacitance Tolerance:	±20%				
Leakage Current DCL:	0.01CV				
Rated Voltage (V _R)	-55°C ≤ +40°C:	4	6.3	10	
Category Voltage (V _C)	at 85°C:	2	3.2	5	
Category Voltage (V _C)	at 125°C:	0.8	1.3	2	
Temperature Range:	-55°C to +125°C with category voltage				
Reliability:	0.2% per 1000 hours at 85°C, 0.5xV _R with 0.1Ω/V series impedance with 60% confidence level				

TLN PulseCap™ Series



High Capacitance Tantalum Solid Electrolytic Chip Capacitors Undertab Series

CAPACITANCE AND RATED VOLTAGE RANGE (FIGURE DENOTES CASE SIZE)

Capacitance		Voltage Rating DC (V _R) to 85°C		
µF	Code	4V (G)	6.3V (J)	10V (A)
680	687			
1000	108			4(100)/6(55)
1500	158		4(100)	6(55)
2200	228		6(55)	
3300	338	6(55)	6*	

Available Ratings (ESR ratings in mOhms in brackets)

Engineering samples - please contact manufacturer

*Codes under development – subject to change

Note: Voltage ratings are minimum values. AVX reserves the right to supply higher ratings in the same case size, to the same reliability standards.

RATINGS & PART NUMBER REFERENCE

AVX Part No.	Case Size	Capacitance (µF)	Rated Voltage (V)	Rated Temperature (°C)	Category Voltage (V)	Category Temperature (°C)	DCL Max. (µA)	ESR Max. @ 100kHz (mΩ)	MSL	100kHz RMS Current (mA)		
										25°C	85°C	125°C
4 Volt @ 40°C												
TLN6338M004#0055	6	3300	4	40	0.8	125	132	55	3	2045	1840	818
6.3 Volt @ 40°C												
TLN4158M006#0100	4	1500	6.3	40	1.3	125	90	100	3	1285	1156	514
TLN6228M006#0055	6	2200	6.3	40	1.3	125	132	55	3	2045	1840	818
10 Volt @ 40°C												
TLN4108M010#0100	4	1000	10	40	2	125	100	100	3	1285	1156	514
TLN6108M010#0055	6	1000	10	40	2	125	100	55	3	2045	1840	818
TLN6158M010#0055	6	1500	10	40	2	125	150	55	3	2045	1840	818

Moisture Sensitivity Level (MSL) is defined according to J-STD-020.

All technical data relates to an ambient temperature of +25°C. Capacitance and DF are measured at 120Hz, 0.5V RMS with a maximum DC bias of 2.2 volts. DCL is measured at rated voltage after 5 minutes.

ESR allowed to move up to 1.25 times catalogue limit post mounting

DCL allowed to move up to 2.00 times catalogue limit post mounting

For typical weight and composition see page 222.

NOTE: AVX reserves the right to supply a higher voltage rating or tighter tolerance part in the same case size, to the same reliability standards.

TLN PulseCap™ Series



High Capacitance Tantalum Solid Electrolytic Chip Capacitors Undertab Series

QUALIFICATION TABLE

TEST	TLN PulseCap™ series (Temperature range -55°C to +125°C)									
	Condition			Characteristics						
Endurance	Determine after application of rated voltage for 2000 +48/-0 hours at 40±2°C and then leaving 1-2 hours at room temperature. Also determine of 85°C temperature, category voltage for 2000 +48/-0 hours and then leaving 1-2 hours at room temperature. Power supply impedance to be ≤0.1Ω/V.			Visual examination	no visible damage					
				DCL	2 x initial limit					
				ΔC/C	within +5/-30% of initial value					
				ESR	1.25 x initial limit					
Humidity	Determine after storage without applied voltage at 65±2°C and 90-95% relative humidity for 500 hours and then recovery 1-2 hours at room temperature.			Visual examination	no visible damage					
				DCL	2 x initial limit					
				ΔC/C	within ±10% of initial value					
				ESR	1.25 x initial limit					
Temperature Stability	Step	Temperature°C	Duration(min)	+20°C	-55°C	+20°C	+85°C	+125°C	+20°C	
	1	+20±2	15	DCL	2 x IL*	n/a	2 x IL*	20 x IL*	25 x IL*	2 x IL*
	2	-55+0/-3	15							
	3	+20±2	15							
	4	+85+3/-0	15	ΔC/C	n/a	+5/-20%	±10%	+20/-0%	+25/-0%	±10%
	5	+125+3/-0	15	ESR	1.25 x IL*	2.5 x IL*	1.25 x IL*	1.25 x IL*	1.25 x IL*	1.25 x IL*
	6	+20±2	15							
Surge Voltage	Test temperature: 40°C+3/0°C Test voltage: 1.3 x rated voltage Series protection resistance 1000±100Ω Discharge resistance: 1000Ω Number of cycles: 1000x Cycle duration: 6 min; 30 sec charge, 5 min 30 sec discharge			Visual examination	no visible damage					
				DCL	2 x initial limit					
				ΔC/C	within ±5% of initial value					
				ESR	1.25 x initial limit					

*Initial Limit

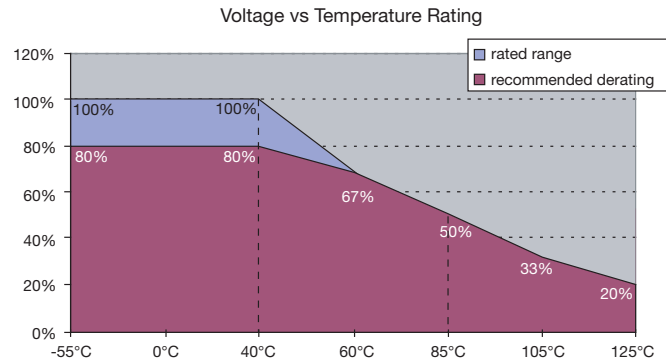

F98 Series



Resin-Molded Chip, High CV Undertab



FEATURES

- Compliant to the RoHS2 directive 2011/65/EU
- SMD face down design
- Small and low profile



APPLICATIONS

- Smartphone
- Mobile phone
- Wireless module
- Hearing aid

CASE DIMENSIONS: millimeters (inches)

Code	EIA Code	EIA Metric	L	W ₁	W ₂	H	S ₁	S ₂
M	0603	1608-09	1.60 ^{+0.20} _{-0.10} (0.063 ^{+0.008} _{-0.004})	0.85 ^{+0.20} _{-0.10} (0.033 ^{+0.008} _{-0.004})	0.65±0.10 (0.026±0.004)	0.80±0.10 ^{*3} (0.031±0.004)	0.50±0.10 (0.020±0.004)	0.60±0.10 (0.024±0.004)
S	0805	2012-09	2.00 ^{+0.20} _{-0.10} (0.079 ^{+0.008} _{-0.004})	1.25 ^{+0.20} _{-0.10} (0.049 ^{+0.008} _{-0.004})	0.90±0.10 (0.035±0.004)	0.80±0.10 (0.031±0.004)	0.50±0.10 (0.020±0.004)	1.00±0.10 (0.039±0.004)
U	0402	1106-06	1.10±0.05 (0.043±0.002)	0.60±0.05 (0.024±0.002)	0.35±0.05 (0.014±0.002)	0.55±0.05 (0.022±0.002)	0.30±0.05 (0.012±0.002)	0.50±0.05 (0.020±0.002)

*3 F980J107MMAAXE: 1.0mm Max.

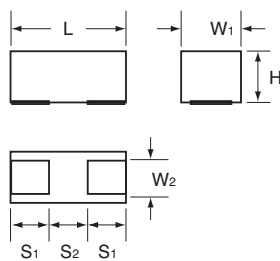

MARKING

U CASE



M CASE

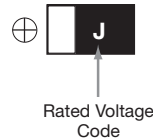

S CASE

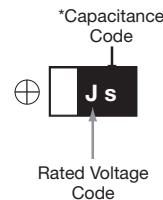

HOW TO ORDER

F98

Type

0J

Rated Voltage

106

Capacitance Code

pF code: 1st two digits represent significant figures, 3rd digit represents multiplier (number of zeros to follow)

M

Tolerance
M = ±20%

M

Case Size
See table above

□

Packaging
See Tape & Reel Packaging Section

□□□

Specification Suffix
LZT = Rated temperature 60°C only
AXE = Rated temperature 60°C and H dimension 1.0mm Max

TECHNICAL SPECIFICATIONS

Category Temperature Range:	-55 to +125°C
Rated Temperature:	+85°C
Capacitance Tolerance:	±20% at 120Hz
Dissipation Factor:	Refer to next page
ESR 100kHz:	Refer to next page
Leakage Current:	Refer to next page Provided that: After 5 minute's application of rated voltage, leakage current at 85°C 10 times or less than 20°C specified value. After 5 minute's application of rated voltage, leakage current at 125°C 12.5 times or less than 20°C specified value.

F98 Series



Resin-Molded Chip, High CV Undertab

CAPACITANCE AND RATED VOLTAGE RANGE (LETTER DENOTES CASE SIZE)

Capacitance		Rated Voltage								*Cap Code
µF	Code	2.5 (0e)	4V (0G)	6.3V (0J)	10V (1A)	16V (1C)	20V (1D)	25V (1E)	35V (1V)	
0.47	474					U**	U**			N
1.0	105					M	M	M	S	A
2.2	225				M/U	M				J
4.7	475		U	M/U	M/U**	M				S
10	106		U	M/U**	M	S				a
15	156		U							e
22	226		M/U**	M	M**/S					J
33	336		M	M	M**/S					n
47	476	M	M	M*/S	S					s
68	686		M/S							w
100	107		M/S	M*/S						A
220	227		S							J

Released ratings

*Ratings under development - subject to change

** Rated temperature 60°C and H dimension 1.0mm Max only. Please contact AVX when you need detail spec.

**Rated temperature 60°C only. Please contact AVX when you need detail spec.

We can consider the type of compliance to AEC-Q200.

Please contact to your local AVX sales office when these series are being designed in your application.

RATINGS & PART NUMBER REFERENCE

AVX Part No.	Case Size	Capacitance (µF)	Rated Voltage (V)	*2 DCL (µA)	DF @ 120Hz (%)	ESR @ 100kHz (Ω)	*1 ΔC/C (%)
2.5 Volt							
F980E476MMA	M	47	2.5	1.2	30	4	±30
4 Volt							
F980G475MUA	U	4.7	4	0.5	20	20	±30
F980G106MUA	U	10	4	0.8	25	20	±30
F980G156MUA	U	15	4	9.0	40	25	±30
F980G226MMA	M	22	4	0.9	15	7.5	±30
F980G226MUALZT	U	22	4	25.0	40	20	±30
F980G336MMA	M	33	4	1.3	30	4	±30
F980G476MMA	M	47	4	1.9	40	8	±30
F980G686MMA	M	68	4	27.2	50	10	±30
F980G686MSA	S	68	4	2.7	30	4	±30
F980G107MMA	M	100	4	80.0	60	10	±30
F980G107MSA	S	100	4	4.0	35	4	±30
F980G227MSA	S	220	4	132	80	5	±30
6.3 Volt							
F980J475MMA	M	4.7	6.3	0.5	20	7.5	±30
F980J475MUA	U	4.7	6.3	0.6	20	20	±30
F980J106MMA	M	10	6.3	0.6	8	6	±30
F980J106MUALZT	U	10	6.3	6.3	30	30	±30
F980J226MMA	M	22	6.3	1.4	20	6	±30
F980J336MMA	M	33	6.3	4.2	35	8	±30
F980J476MMA	M	47	6.3	29.6	45	10	±30
F980J476MSA	S	47	6.3	3.0	25	6	±30
F980J107MMAAXE	M	100	6.3	126	80	10	±30
F980J107MSA	S	100	6.3	63.0	50	8	±30

*2: Leakage Current

After 5 minute's application of rated voltage, leakage current at 20°C.

AVX Part No.	Case Size	Capacitance (µF)	Rated Voltage (V)	*2 DCL (µA)	DF @ 120Hz (%)	ESR @ 100kHz (Ω)	*1 ΔC/C (%)
10 Volt							
F981A225MMA	M	2.2	10	0.5	6	7.5	±30
F981A225MUA	U	2.2	10	0.5	15	15	±30
F981A475MMA	M	4.7	10	0.5	6	6	±30
F981A475MUALZT	U	4.7	10	4.7	25	25	±30
F981A106MMA	M	10	10	1.0	20	7.5	±30
F981A226MMALZT	M	22	10	11.0	30	8	±30
F981A226MSA	S	22	10	2.2	20	4	±30
F981A336MMALZT	M	33	10	33.0	45	8	±30
F981A336MSA	S	33	10	3.3	30	6	±30
F981A476MSA	S	47	10	9.4	35	5	±30
16 Volt							
F981C105MMA	M	1	16	0.5	6	10	±30
F981C225MMA	M	2.2	16	0.5	6	10	±30
F981C475MMA	M	4.7	16	0.8	12	12	±30
F981C106MSA	S	10	16	1.6	18	4	±30
20 Volt							
F981D105MMA	M	1	20	0.5	6	10	±30
25 Volt							
F981E105MMA	M	1	25	0.5	8	10	±30
35 Volt							
F981V105MSA	S	1	35	0.7	20	8	±30

QUALIFICATION TABLE

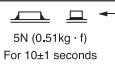
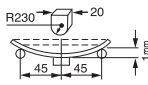
TEST	F98 series (Temperature range -55°C to +125°C)	
	Condition	
Damp Heat (Steady State)	At 40°C, 90 to 95% R.H., 500 hours (No voltage applied) Capacitance Change Refer to page 49 (*1) Dissipation Factor 150% or less of initial specified value Leakage Current 200% or less of initial specified value	
Temperature Cycles	-55°C / +125°C, 30 minutes each, 5 cycles Capacitance Change Refer to page 49 (*1) Dissipation Factor 150% or less of initial specified value Leakage Current 200% or less of initial specified value	
Resistance to Soldering Heat	10 seconds reflow at 260°C, 5 seconds immersion at 260°C. Capacitance Change Refer to page 49 (*1) Dissipation Factor Initial specified value or less Leakage Current Initial specified value or less	
Surge	After application of surge in series with a 1kΩ resistor at the rate of 30 seconds ON, 30 seconds OFF, for 1000 successive test cycles at 85°C, capacitors shall meet the characteristic requirements in the table above. Capacitance Change Refer to page 49 (*1) Dissipation Factor 150% or less of initial specified value Leakage Current 200% or less of initial specified value	
Endurance	After 1000 hours' application of rated voltage in series with a 3Ω resistor at 85°C, capacitors shall meet the characteristic requirements in the table above. Capacitance Change Refer to page 49 (*1) Dissipation Factor 150% or less of initial specified value Leakage Current 200% or less of initial specified value	
Shear Test	After applying the pressure load of 5N for 10±1 seconds horizontally to the center of capacitor side body which has no electrode and has been soldered beforehand on a substrate, there shall be found neither exfoliation nor its sign at the terminal electrode.	
Terminal Strength	Keeping a capacitor surface-mounted on a substrate upside down and supporting the substrate at both of the opposite bottom points 45mm apart from the center of capacitor, the pressure strength is applied with a specified jig at the center of substrate so that the substrate may bend by 1mm as illustrated. Then, there shall be found no remarkable abnormality on the capacitor terminals.	

F98-AS1 Series



Fused Face-Down, High CV



FEATURES

- Compliant to the RoHS2 directive 2011/65/EU

APPLICATIONS

- Industrial equipment
- Smartphone
- Medical equipment
- Automotive electronics
- Portable game



CASE DIMENSIONS: millimeters (inches)

Code	EIA Code	EIA Metric	L	W ₁	W ₂	H	S ₁	S ₂
M	0603	1608-09	1.60 ^{+0.20} _{-0.10} (0.063 ^{+0.008} _{-0.004})	0.85 ^{+0.20} _{-0.10} (0.033 ^{+0.008} _{-0.004})	0.65±0.10 (0.026±0.004)	0.80±0.10 (0.031±0.004)	0.50±0.10 (0.020±0.004)	0.60±0.10 (0.024±0.004)
S	0805	2012-09	2.00 ^{+0.20} _{-0.10} (0.079 ^{+0.008} _{-0.004})	1.25 ^{+0.20} _{-0.10} (0.049 ^{+0.008} _{-0.004})	0.90±0.10 (0.035±0.004)	0.80±0.10 (0.031±0.004)	0.50±0.10 (0.020±0.004)	1.00±0.10 (0.039±0.004)

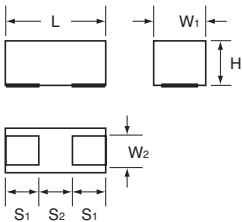

MARKING

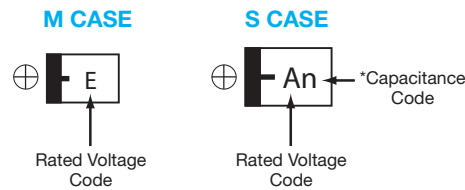

HOW TO ORDER

F98 | **1A** | **336** | **M** | **S** | **AS1**

Type | Rated Voltage | Capacitance Code | Tolerance | Case Size | Packaging | Fuse Series Code

pF code: 1st two digits represent significant figures, 3rd digit represents multiplier (number of zeros to follow)

M = ±20%

Reel Dia (φ180)	Tape Width (mm)
A	8

TECHNICAL SPECIFICATIONS

Category Temperature Range:	-55 to +125°C
Rated Temperature:	+85°C
Capacitance Tolerance:	±20% at 120Hz
Dissipation Factor:	Refer to next page
ESR 100kHz:	Refer to next page
Leakage Current:	Refer to next page
	Provided that:
	After 5 minute's application of rated voltage, leakage current at 85°C 10 times or less than 20°C specified value.
	After 5 minute's application of rated voltage, leakage current at 125°C 12.5 times or less than 20°C specified value.

F98-AS1 Series



Fused Face-Down, High CV

CAPACITANCE AND RATED VOLTAGE RANGE (LETTER DENOTES CASE SIZE)

Capacitance		Rated Voltage					*Cap Code
μF	Code	10V (1A)	16V (1C)	20V (1D)	25V (1E)	35 (1V)	
1.0	105		M*	M*	M*	S	A
2.2	225	M*	M*				J
4.7	475	M*	M*				S
10	106	M*	S				a
22	226	M*/S					J
33	336	M*/S					n
47	476	S					s

Available Ratings

*Codes under development – subject to change

Please contact to your local AVX sales office when these series are being designed in your application.

RATINGS & PART NUMBER REFERENCE

AVX Part No.	Case Size	Capacitance (μF)	Rated Voltage (V)	*2 DCL (μA)	DF @ 120Hz (%)	ESR @ 100kHz (Ω)	*1 ΔC/C (%)
10 Volt							
F981A226MSAAS1	S	22	10	2.2	20	4.5	±20
F981A336MSAAS1	S	33	10	3.3	30	6.5	±30
F981A476MSAAS1	S	47	10	9.4	35	5.5	±30
16 Volt							
F981C106MSAAS1	S	10	16	1.6	18	4.5	±20
35 Volt							
F981V105MSAAS1	S	1	35	0.7	20	8.5	±30

*2: Leakage Current
After 5 minute's application of rated voltage, leakage current at 20°C.

QUALIFICATION TABLE

TEST	F98-AS1 series (Temperature range -55°C to +125°C)	
	Condition	
Damp Heat (Steady State)	At 40°C, 90 to 95% R.H., 500 hours (No voltage applied) Capacitance Change Refer to the table above (*1) Dissipation Factor 150% or less of initial specified value Leakage Current 200% or less of initial specified value	
Temperature Cycles	-55°C / +125°C, 30 minutes each, 5 cycles Capacitance Change Refer to the table above (*1) Dissipation Factor 150% or less of initial specified value Leakage Current 200% or less of initial specified value	
Resistance to Soldering Heat	10 seconds reflow at 260°C, 5 seconds immersion at 260°C. Capacitance Change Refer to the table above (*1) Dissipation Factor Initial specified value or less Leakage Current Initial specified value or less	
Surge	After application of surge in series with a 1kΩ resistor at the rate of 30 seconds ON, 30 seconds OFF, for 1000 successive test cycles at 85°C, capacitors shall meet the characteristic requirements in the table above. Capacitance Change Refer to the table above (*1) Dissipation Factor 150% or less of initial specified value Leakage Current 200% or less of initial specified value	
Endurance	After 1000 hours' application of rated voltage in series with a 3Ω resistor at 85°C, capacitors shall meet the characteristic requirements in the table above. Capacitance Change Refer to the table above (*1) Dissipation Factor 150% or less of initial specified value Leakage Current 200% or less of initial specified value	
Shear Test	After applying the pressure load of 5N for 10±1 seconds horizontally to the center of capacitor side body which has no electrode and has been soldered beforehand on a substrate, there shall be found neither exfoliation nor its sign at the terminal electrode.	
Terminal Strength	Keeping a capacitor surface-mounted on a substrate upside down and supporting the substrate at both of the opposite bottom points 45mm apart from the center of capacitor, the pressure strength is applied with a specified jig at the center of substrate so that the substrate may bend by 1mm as illustrated. Then, there shall be found no remarkable abnormality on the capacitor terminals.	
Fuse activation	5 seconds max. with 2A min. applied current	

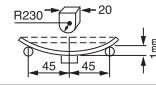
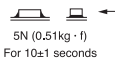

NOTICE: DESIGN, SPECIFICATIONS ARE SUBJECT TO CHANGE WITHOUT NOTICE.

TPS Series

Low ESR

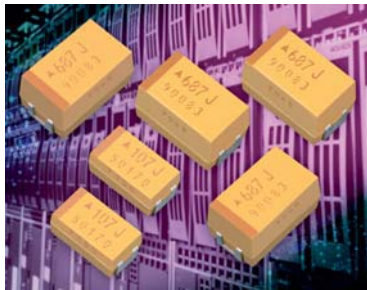

FEATURES

- Low ESR series of robust MnO₂ solid electrolyte capacitors
- CV range: 0.15-1500µF / 2.5-50V
- 14 case sizes available
- Power supply applications



SnPb termination option is not RoHS compliant.

APPLICATIONS

- General medium power DC/DC convertors

CASE DIMENSIONS: millimeters (inches)

Code	EIA Code	EIA Metric	L±0.20 (0.008)	W+0.20 (0.008) -0.10 (0.004)	H+0.20 (0.008) -0.10 (0.004)	W ₁ ±0.20 (0.008)	A+0.30 (0.012) -0.20 (0.008)	S Min.
A	1206	3216-18	3.20 (0.126)	1.60 (0.063)	1.60 (0.063)	1.20 (0.047)	0.80 (0.031)	1.10 (0.043)
B	1210	3528-21	3.50 (0.138)	2.80 (0.110)	1.90 (0.075)	2.20 (0.087)	0.80 (0.031)	1.40 (0.055)
C	2312	6032-28	6.00 (0.236)	3.20 (0.126)	2.60 (0.102)	2.20 (0.087)	1.30 (0.051)	2.90 (0.114)
D	2917	7343-31	7.30 (0.287)	4.30 (0.169)	2.90 (0.114)	2.40 (0.094)	1.30 (0.051)	4.40 (0.173)
E	2917	7343-43	7.30 (0.287)	4.30 (0.169)	4.10 (0.162)	2.40 (0.094)	1.30 (0.051)	4.40 (0.173)
F	2312	6032-20	6.00 (0.236)	3.20 (0.126)	2.00 (0.079) max.	2.20 (0.087)	1.30 (0.051)	2.90 (0.114)
P	0805	2012-15	2.05 (0.081)	1.35 (0.053)	1.50 (0.059) max.	1.00±0.10 (0.039±0.004)	0.50 (0.020)	0.85 (0.033)
R	0805	2012-12	2.05 (0.081)	1.30 (0.051)	1.20 (0.047) max.	1.00±0.10 (0.039±0.004)	0.50 (0.020)	0.85 (0.033)
S	1206	3216-12	3.20 (0.126)	1.60 (0.063)	1.20 (0.047) max.	1.20 (0.047)	0.80 (0.031)	1.10 (0.043)
T	1210	3528-12	3.50 (0.138)	2.80 (0.110)	1.20 (0.047) max.	2.20 (0.087)	0.80 (0.031)	1.40 (0.055)
V	2924	7361-38	7.30 (0.287)	6.10 (0.240)	3.55 (0.140)	3.10 (0.120)	1.30 (0.051)	4.40 (0.173)
W	2312	6032-15	6.00 (0.236)	3.20 (0.126)	1.50 (0.059) max.	2.20 (0.087)	1.30 (0.051)	2.90 (0.114)
X	2917	7343-15	7.30 (0.287)	4.30 (0.169)	1.50 (0.059) max.	2.40 (0.094)	1.30 (0.051)	4.40 (0.173)
Y	2917	7343-20	7.30 (0.287)	4.30 (0.169)	2.00 (0.079) max.	2.40 (0.094)	1.30 (0.051)	4.40 (0.173)

W1 dimension applies to the termination width for A dimensional area only.

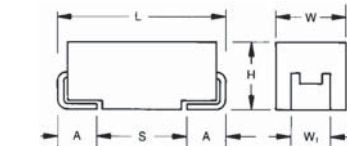

MARKING

A, B, C, D, E, F, S, T, V, W, X, Y CASE

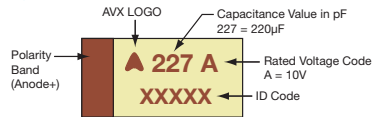

P, R CASE

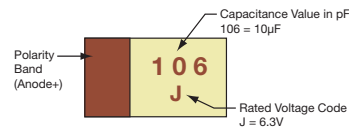

HOW TO ORDER

TPS	C	107	M	010	R	0100	-
Type	Case Size See table above	Capacitance Code pF code: 1st two digits represent significant figures, 3rd digit represents multiplier (number of zeros to follow)	Tolerance K = ±10% M = ±20%	Rated DC Voltage 002 = 2.5Vdc 004 = 4Vdc 006 = 6.3Vdc 010 = 10Vdc 016 = 16Vdc 020 = 20Vdc 025 = 25Vdc 035 = 35Vdc 050 = 50Vdc	Packaging R = Pure Tin 7" Reel S = Pure Tin 13" Reel A = Gold Plating 7" Reel B = Gold Plating 13" Reel H = Tin Lead 7" Reel (Contact Manufacturer) K = Tin Lead 13" Reel (Contact Manufacturer) H, K = Non RoHS	ESR in mΩ	Additional characters may be added for special requirements V = Dry pack Option (selected ratings only)

TECHNICAL SPECIFICATIONS

Technical Data:	All technical data relate to an ambient temperature of +25°C									
Capacitance Range:	0.15 µF to 1500 µF									
Capacitance Tolerance:	±10%; ±20%									
Rated Voltage (V _R)	≤ +85°C:	2.5	4	6.3	10	16	20	25	35	50
Category Voltage (V _C)	≤ +125°C:	1.7	2.7	4	7	10	13	17	23	33
Surge Voltage (V _S)	≤ +85°C:	3.3	5.2	8	13	20	26	32	46	65
Surge Voltage (V _S)	≤ +125°C:	2.2	3.4	5	8	13	16	20	28	40
Temperature Range:	-55°C to +125°C									
Environmental Classification:	55/125/56 (IEC 68-2)									
Reliability:	1% per 1000 hours at 85°C, V _R with 0.1Ω/V series impedance, 60% confidence level									
Termination Finished:	Sn Plating (standard), Gold and SnPb Plating upon request									
	For AEC-Q200 availability, please contact AVX									



CAPACITANCE AND RATED VOLTAGE RANGE (LETTER DENOTES CASE SIZE)

Capacitance		Rated Voltage DC (V _R) to 85°C								
µF	Code	2.5V (e)	4V (G)	6.3V (J)	10V (A)	16V (C)	20V (D)	25V (E)	35V (V)	50V (T)
0.15	154									A(9000)
0.22	224								A(6000)	A(7000)
0.33	334								A(6000)	A(7000)
0.47	474							A(7000)	A(6000) B(4000)	A(6500), B(6000) C(2300)
0.68	684							A(6000)	A(6000)	B(4000)
1.0	105				R(9000)	A(6200)	A(3000), R(6000) S(6000), T(2000)	A(4000) R(2500,4000)	A(3000) B(2000)	A(3000) C(2500)
1.5	155						A(3000)	A(3000) B(1800)	A(3000) B(2500)	C(1500,2000)
2.2	225			R(7000)	A(1800)	A(1800,3500) T(2000)	A(3000), B(1700)	A(2500) B(1300)	A(1500), B(750), 1500,2000, C(1000)	C(1500) D(1200)
3.3	335			A(2100)	T(1500)	A(3500), B(2500)	A(2500) B(1300)	A(1000,1500) B(750,1500,2000)	B(1000) C(700)	C(1000) D(800)
4.7	475			S(4000)	A(1400), B(1400) R(3000,5000)	A(2000) B(800,1500)	A(1800) B(750,1000)	B(700,900,1500) C(700)	B(700,1500) C(600), D(700)	C(800) D(250,300,500,700) X(500)
6.8	685			A(1800)	A(1800), B(1300) T(1800)	A(1500) B(600,1200)	A(1000) B(600,1000) C(700)	B(700) C(500,600,700)	C(350) D(150,400,500)	D(200, 300, 500,600)
10	106		R(3000)	A(1500), B(1500) R(1000,1500,3000) T(1000)	A(900,1800), B(1000) P(2000) ^M , S(900) T(1000,2000)	A(1000), B(500,800) C(500), T(800,1000) W(500,600)	B(500,1000) C(500,700) W(250, 500)	B(1800) C(300,500) D(500)	C(600) D(125,300) E(200), Y(250)	D(500) E(250,300, 400,500)
15	156			A(700,1500)	A(1000) B(450,600), C(700) T(1200)	B(500,800) C(300,700)	B(500) C(400,450)	C(220,300) D(100,300)	C(350,450) D(100,300) Y(250)	E(250) V(250)
22	226			A(500,900) B(375,600) C(500), S(900)	A(900) B(400,500,700) C(300), T(800)	B(400,600) C(150,250,300,375) D(700), W(500)	B(400,600) C(100,150,400) D(200,300)	C(275,400) D(100,200,300) F(300)	D(125,200,300,400) E(125,200,300) Y(200)	
33	336			A(600) B(250,350,450,600) T(800)	A(700) B(250,425,500,650) C(150,375,500) W(350)	B(350,500) C(100,150,225,300) D(200), W(140,175, 250,400,500) Y(300,400)	C(300) D(100,200)	C(400) D(100,200,300) E(100,175, 200,300) Y(200)	D(200,300) E(100,250,300) V(200)	
47	476		A(500)	A(800) B(250,350,500) C(300), T(1200)	B(250,350,500,650) C(200,350) D(100,300) W(125,150,250)	C(110,350) D(80,100,150,200) W(200) X(180), Y(250)	D(75,100,200) E(70,125,150, 200,250) X(200)	D(125,150,250) E(80,100,125) Y(250)	E(200,250) V(150,200)	
68	686			B(250,350,500) C(150,200) W(110,125,250)	B(600) C(80,100,200,300) D(100,150), W(100,150) Y(100,200)	C(125,200) D(70,100,150) F(200), X(150) Y(150,200,250)	D(70,150, 200,300) E(125,150,200) Y(200)	D(150,200,300) E(125,200) V(80,95,150,200)	V(150,200)	
100	107	B(200)	B(200,250, 350,500) W(100)	B(250,400) C(75,150), D(300) W(100,150) Y(100)	B(400) C(75,100,150,200) D(50,65,80,100,125, 150), E(125) W(150) X(85,150,200) Y(100,150,200)	C(200) D(60,100,125,150) E(55,100,125,150) F(150,200) ^M Y(100,150,200)	D(85,100,150) E(100,150,200) V(60,85,100,200)	E(150), V(100)		
150	157	B(150)	B(250) C(70,80)	C(50,90,150,200,250) D(50,125), Y(40,50)	C(150), D(50,85,100), E(100), F(200), X(100) ^M Y(100,150,200)	D(60,85,100,125,150) E(100), V(45,75) Y(200) ^M	V(80)	V(150) ^M		
220	227	B(150, 200,600) D(45)	D(40,50,100) Y(40,50,75)	C(70,100,125,250) D(50,100,125) E(100), F(200) Y(100,150)	D(40,50,100,150) E(50,60,70,100, 125,150) Y(100,150,200)	E(100,150) V(50,75,100,150)				
330	337	Y(40)	C(100) D(35,45,100) F(200) X(100)	C(80,100) D(45,50,70,100) E(50,100,125,150) V(100), Y(75,100,150)	D(50,65,100,150) E(40,50,60,100) V(40,60,100)	E(200) ^M				
470	477	D(35) F(200) Y(100)	D(45,100) E(35,45,100)	D(45,60,100,200) E(45,50,60,100,200) V(40,55,100), Y(150)	E(45,50,60,100,200) V(40,60,100)					
680	687	D(35,50) E(35,50) Y(100)	D(45,60,100) E(40,60,100)	E(45,60,100) V(35,40,50)	E(150) ^M V(100) ^M					
1000	108	E(30,40) Y(100) ^M	E(40,60) V(25,35,40,50)	E(100) ^M , V(40,50) ^M						
1500	158	D(100) E(50) V(30,40) ^M	E(50,75) V(50,75) ^M							

Not recommended for new designs; higher voltage or smaller case size alternatives are available.

Released ratings^M (ESR ratings in mOhms in parentheses)

Engineering samples - please contact AVX

*Ratings under development – subject to change

NOTE: Voltage ratings are minimum values. AVX reserves the right to supply higher voltage ratings in the same case size, to the same reliability standards.

RATINGS & PART NUMBER REFERENCE

AVX Part No.	Case Size	Capacitance (μF)	Rated Voltage (V)	Rated Temperature (°C)	Category Voltage (V)	Category Temperature (°C)	DCL Max. (μA)	DF Max. (%)	ESR Max. @ 100kHz (mΩ)	MSL	100kHz RMS Current (A)		
											25°C	85°C	125°C
2.5 Volt @ 85°C													
TPSB107*002#0200	B	100	2.5	85	1.7	125	2.5	8	200	1	0.652	0.587	0.261
TPSB157*002#0150	B	150	2.5	85	1.7	125	3	10	150	1	0.753	0.677	0.301
TPSB227*002#0150	B	220	2.5	85	1.7	125	4.4	16	150	1	0.753	0.677	0.301
TPSB227*002#0200	B	220	2.5	85	1.7	125	4.4	16	200	1	0.652	0.587	0.261
TPSB227*002#0600	B	220	2.5	85	1.7	125	4.4	16	600	1	0.376	0.339	0.151
TPSD227*002#0045	D	220	2.5	85	1.7	125	5.5	8	45	1	1.826	1.643	0.730
TPSY337*002#0040	Y	330	2.5	85	1.7	125	8.2	8	40	1 ¹⁾	1.768	1.591	0.707
TPSD477*002#0035	D	470	2.5	85	1.7	125	11.6	8	35	1	2.070	1.863	0.828
TPSF477*002#0200	F	470	2.5	85	1.7	125	11.8	12	200	1	0.707	0.636	0.283
TPSY477*002#0100	Y	470	2.5	85	1.7	125	11	12	100	1 ¹⁾	1.118	1.006	0.447
TPSD687*002#0035	D	680	2.5	85	1.7	125	17	16	35	1	2.070	1.863	0.828
TPSD687*002#0050	D	680	2.5	85	1.7	125	17	16	50	1	1.732	1.559	0.693
TPSE687*002#0035	E	680	2.5	85	1.7	125	17	10	35	1 ¹⁾	2.171	1.954	0.868
TPSE687*002#0050	E	680	2.5	85	1.7	125	17	10	50	1 ¹⁾	1.817	1.635	0.727
TPSY687*002#0100	Y	680	2.5	85	1.7	125	17	12	100	1 ¹⁾	1.118	1.006	0.447
TPSE108*002#0030	E	1000	2.5	85	1.7	125	25	14	30	1 ¹⁾	2.345	2.111	0.938
TPSE108*002#0040	E	1000	2.5	85	1.7	125	25	14	40	1 ¹⁾	2.031	1.828	0.812
TPSY108M002#0100	Y	1000	2.5	85	1.7	125	25	30	100	1 ¹⁾	1.118	1.006	0.447
TPSD158*002#0100	D	1500	2.5	85	1.7	125	37.5	60	100	1	1.125	1.102	0.490
TPSE158*002#0050	E	1500	2.5	85	1.7	125	37.5	20	50	1 ¹⁾	1.817	1.635	0.727
TPSV158M002#0030	V	1500	2.5	85	1.7	125	30	20	30	1 ¹⁾	2.887	2.598	1.155
TPSV158M002#0040	V	1500	2.5	85	1.7	125	30	20	40	1 ¹⁾	2.500	2.250	1.000
4 Volt @ 85°C													
TPSR106*004#3000	R	10	4	85	2.7	125	0.5	6	3000	1	0.135	0.122	0.054
TPSA476*004#0500	A	47	4	85	2.7	125	1.9	8	500	1	0.387	0.349	0.155
TPSB107*004#0200	B	100	4	85	2.7	125	4	8	200	1	0.652	0.587	0.261
TPSB107*004#0250	B	100	4	85	2.7	125	4	8	250	1	0.583	0.525	0.233
TPSB107*004#0350	B	100	4	85	2.7	125	4	8	350	1	0.493	0.444	0.197
TPSB107*004#0500	B	100	4	85	2.7	125	4	8	500	1	0.412	0.371	0.165
TPSW107*004#0100	W	100	4	85	2.7	125	4	6	100	1	0.949	0.854	0.379
TPSB157*004#0250	B	150	4	85	2.7	125	6	10	250	1	0.583	0.525	0.233
TPSC157*004#0070	C	150	4	85	2.7	125	6	6	70	1	1.254	1.128	0.501
TPSC157*004#0080	C	150	4	85	2.7	125	6	6	80	1	1.173	1.055	0.469
TPSD227*004#0040	D	220	4	85	2.7	125	8.8	8	40	1	1.936	1.743	0.775
TPSD227*004#0050	D	220	4	85	2.7	125	8.8	8	50	1	1.732	1.559	0.693
TPSD227*004#0100	D	220	4	85	2.7	125	8.8	8	100	1	1.225	1.102	0.490
TPSY227*004#0040	Y	220	4	85	2.7	125	8.8	8	40	1 ¹⁾	1.768	1.591	0.707
TPSY227*004#0050	Y	220	4	85	2.7	125	8.8	8	50	1 ¹⁾	1.581	1.423	0.632
TPSY227*004#0075	Y	220	4	85	2.7	125	8.8	8	75	1 ¹⁾	1.291	1.162	0.516
TPSC337*004#0100	C	330	4	85	2.7	125	13.2	8	100	1	1.049	0.944	0.420
TPSD337*004#0035	D	330	4	85	2.7	125	13.2	8	35	1	2.070	1.863	0.828
TPSD337*004#0045	D	330	4	85	2.7	125	13.2	8	45	1	1.826	1.643	0.730
TPSD337*004#0100	D	330	4	85	2.7	125	13.2	8	100	1	1.225	1.102	0.490
TPSF337*004#0200	F	330	4	85	2.7	125	13.2	10	200	1	0.707	0.636	0.283
TPSX337*004#0100	X	330	4	85	2.7	125	13.2	8	100	1 ¹⁾	1.000	0.900	0.400
TPSD477*004#0045	D	470	4	85	2.7	125	18.8	12	45	1	1.826	1.643	0.730
TPSD477*004#0100	D	470	4	85	2.7	125	18.8	12	100	1	1.225	1.102	0.490
TPSE477*004#0035	E	470	4	85	2.7	125	18.8	10	35	1 ¹⁾	2.171	1.954	0.868
TPSE477*004#0045	E	470	4	85	2.7	125	18.8	10	45	1 ¹⁾	1.915	1.723	0.766
TPSE477*004#0100	E	470	4	85	2.7	125	18.8	10	100	1 ¹⁾	1.285	1.156	0.514
TPSD687*004#0045	D	680	4	85	2.7	125	27.2	14	45	1	1.826	1.643	0.730
TPSD687*004#0060	D	680	4	85	2.7	125	27.2	14	60	1	1.581	1.423	0.632
TPSD687*004#0100	D	680	4	85	2.7	125	27.2	14	100	1	1.225	1.102	0.490
TPSE687*004#0040	E	680	4	85	2.7	125	27.2	10	40	1 ¹⁾	2.031	1.828	0.812
TPSE687*004#0060	E	680	4	85	2.7	125	27.2	10	60	1 ¹⁾	1.658	1.492	0.663
TPSE687*004#0100	E	680	4	85	2.7	125	27.2	10	100	1 ¹⁾	1.285	1.156	0.514
TPSE108*004#0040	E	1000	4	85	2.7	125	40	14	40	1 ¹⁾	2.031	1.828	0.812
TPSE108*004#0060	E	1000	4	85	2.7	125	40	14	60	1 ¹⁾	1.658	1.492	0.663
TPSV108*004#0025	V	1000	4	85	2.7	125	40	16	25	1 ¹⁾	3.162	2.846	1.265
TPSV108*004#0035	V	1000	4	85	2.7	125	40	16	35	1 ¹⁾	2.673	2.405	1.069
TPSV108*004#0040	V	1000	4	85	2.7	125	40	16	40	1 ¹⁾	2.500	2.250	1.000
TPSV108*004#0050	V	1000	4	85	2.7	125	40	16	50	1 ¹⁾	2.236	2.012	0.894
TPSE158*004#0050	E	1500	4	85	2.7	125	60	30	50	1 ¹⁾	1.817	1.635	0.727
TPSE158*004#0075	E	1500	4	85	2.7	125	60	30	75	1 ¹⁾	1.483	1.335	0.593
TPSV158M004#0050	V	1500	4	85	2.7	125	60	30	50	1 ¹⁾	2.236	2.012	0.894
TPSV158M004#0075	V	1500	4	85	2.7	125	60	30	75	1 ¹⁾	1.826	1.643	0.730
6.3 Volt @ 85°C													
TPSR225*006#7000	R	2.2	6.3	85	4	125	0.5	6	7000	1	0.089	0.080	0.035
TPSA335*006#2100	A	3.3	6.3	85	4	125	0.5	6	2100	1	0.189	0.170	0.076
TPSS475*006#4000	S	4.7	6.3	85	4	125	0.5	6	4000	1	0.127	0.115	0.051

RATINGS & PART NUMBER REFERENCE

AVX Part No.	Case Size	Capacitance (µF)	Rated Voltage (V)	Rated Temperature (°C)	Category Voltage (V)	Category Temperature (°C)	DCL Max. (µA)	DF Max. (%)	ESR Max. @ 100kHz (mΩ)	MSL	100kHz RMS Current (A)		
											25°C	85°C	125°C
TPSA685*006#1800	A	6.8	6.3	85	4	125	0.5	6	1800	1	0.204	0.184	0.082
TPSA106*006#1500	A	10	6.3	85	4	125	0.6	6	1500	1	0.224	0.201	0.089
TPSB106*006#1500	B	10	6.3	85	4	125	0.6	6	1500	1	0.238	0.214	0.095
TPSR106*006#1000	R	10	6.3	85	4	125	0.6	8	1000	1	0.235	0.211	0.094
TPSR106*006#1500	R	10	6.3	85	4	125	0.6	8	1500	1	0.191	0.172	0.077
TPSR106*006#3000	R	10	6.3	85	4	125	0.6	8	3000	1	0.135	0.122	0.054
TPST106*006#1000	T	10	6.3	85	4	125	0.6	6	1000	1	0.283	0.255	0.113
TPSA156*006#0700	A	15	6.3	85	4	125	0.9	6	700	1	0.327	0.295	0.131
TPSA156*006#1500	A	15	6.3	85	4	125	0.9	6	1500	1	0.224	0.201	0.089
TPSA226*006#0500	A	22	6.3	85	4	125	1.4	6	500	1	0.387	0.349	0.155
TPSA226*006#0900	A	22	6.3	85	4	125	1.4	6	900	1	0.289	0.260	0.115
TPSB226*006#0375	B	22	6.3	85	4	125	1.4	6	375	1	0.476	0.428	0.190
TPSB226*006#0600	B	22	6.3	85	4	125	1.4	6	600	1	0.376	0.339	0.151
TPSC226*006#0500	C	22	6.3	85	4	125	1.4	6	500	1	0.469	0.422	0.188
TPSS226*006#0900	S	22	6.3	85	4	125	1.3	10	900	1	0.269	0.242	0.107
TPSA336*006#0600	A	33	6.3	85	4	125	2.1	8	600	1	0.354	0.318	0.141
TPSB336*006#0250	B	33	6.3	85	4	125	2.1	6	250	1	0.583	0.525	0.233
TPSB336*006#0350	B	33	6.3	85	4	125	2.1	6	350	1	0.493	0.444	0.197
TPSB336*006#0450	B	33	6.3	85	4	125	2.1	6	450	1	0.435	0.391	0.174
TPSB336*006#0600	B	33	6.3	85	4	125	2.1	6	600	1	0.376	0.339	0.151
TPST336*006#0800	T	33	6.3	85	4	125	2.1	10	800	1	0.316	0.285	0.126
TPSA476*006#0800	A	47	6.3	85	4	125	2.8	10	800	1	0.306	0.276	0.122
TPSB476*006#0250	B	47	6.3	85	4	125	3	6	250	1	0.583	0.525	0.233
TPSB476*006#0350	B	47	6.3	85	4	125	3	6	350	1	0.493	0.444	0.197
TPSB476*006#0500	B	47	6.3	85	4	125	3	6	500	1	0.412	0.371	0.165
TPSC476*006#0300	C	47	6.3	85	4	125	3	6	300	1	0.606	0.545	0.242
TPST476*006#1200	T	47	6.3	85	4	125	2.8	10	1200	1	0.258	0.232	0.103
TPSB686*006#0250	B	68	6.3	85	4	125	4	8	250	1	0.583	0.525	0.233
TPSB686*006#0350	B	68	6.3	85	4	125	4	8	350	1	0.493	0.444	0.197
TPSB686*006#0500	B	68	6.3	85	4	125	4	8	500	1	0.412	0.371	0.165
TPSC686*006#0150	C	68	6.3	85	4	125	4.3	6	150	1	0.856	0.771	0.343
TPSC686*006#0200	C	68	6.3	85	4	125	4.3	6	200	1	0.742	0.667	0.297
TPSW686*006#0110	W	68	6.3	85	4	125	4.3	6	110	1	0.905	0.814	0.362
TPSW686*006#0125	W	68	6.3	85	4	125	4.3	6	125	1	0.849	0.764	0.339
TPSW686*006#0250	W	68	6.3	85	4	125	4.3	6	250	1	0.600	0.540	0.240
TPSB107*006#0250	B	100	6.3	85	4	125	6.3	10	250	1	0.583	0.525	0.233
TPSB107*006#0400	B	100	6.3	85	4	125	6.3	10	400	1	0.461	0.415	0.184
TPSC107*006#0075	C	100	6.3	85	4	125	6.3	6	75	1	1.211	1.090	0.484
TPSC107*006#0150	C	100	6.3	85	4	125	6.3	6	150	1	0.856	0.771	0.343
TPSD107*006#0300	D	100	6.3	85	4	125	6.3	6	300	1	0.707	0.636	0.283
TPSW107*006#0100	W	100	6.3	85	4	125	6.3	6	100	1	0.949	0.854	0.379
TPSW107*006#0150	W	100	6.3	85	4	125	6.3	6	150	1	0.775	0.697	0.310
TPSY107*006#0100	Y	100	6.3	85	4	125	6.3	6	100	1 ¹⁾	1.118	1.006	0.447
TPSC157*006#0050	C	150	6.3	85	4	125	9.5	6	50	1	1.483	1.335	0.593
TPSC157*006#0090	C	150	6.3	85	4	125	9.5	6	90	1	1.106	0.995	0.442
TPSC157*006#0150	C	150	6.3	85	4	125	9.5	6	150	1	0.856	0.771	0.343
TPSC157*006#0200	C	150	6.3	85	4	125	9.5	6	200	1	0.742	0.667	0.297
TPSC157*006#0250	C	150	6.3	85	4	125	9.5	6	250	1	0.663	0.597	0.265
TPSD157*006#0050	D	150	6.3	85	4	125	9.5	6	50	1	1.732	1.559	0.693
TPSD157*006#0125	D	150	6.3	85	4	125	9.5	6	125	1	1.095	0.986	0.438
TPSY157*006#0040	Y	150	6.3	85	4	125	9.5	6	40	1 ¹⁾	1.768	1.591	0.707
TPSY157*006#0050	Y	150	6.3	85	4	125	9.5	6	50	1 ¹⁾	1.581	1.423	0.632
TPSC227*006#0070	C	220	6.3	85	4	125	13.9	8	70	1	1.254	1.128	0.501
TPSC227*006#0100	C	220	6.3	85	4	125	13.9	8	100	1	1.049	0.944	0.420
TPSC227*006#0125	C	220	6.3	85	4	125	13.9	8	125	1	0.938	0.844	0.375
TPSC227*006#0250	C	220	6.3	85	4	125	13.9	8	250	1	0.663	0.597	0.265
TPSD227*006#0050	D	220	6.3	85	4	125	13.9	8	50	1	1.732	1.559	0.693
TPSD227*006#0100	D	220	6.3	85	4	125	13.9	8	100	1	1.225	1.102	0.490
TPSD227*006#0125	D	220	6.3	85	4	125	13.9	8	125	1	1.095	0.986	0.438
TPSE227*006#0100	E	220	6.3	85	4	125	13.9	8	100	1 ¹⁾	1.285	1.156	0.514
TPSF227*006#0200	F	220	6.3	85	4	125	13.2	10	200	1	0.707	0.636	0.283
TPSY227*006#0100	Y	220	6.3	85	4	125	13.9	8	100	1 ¹⁾	1.118	1.006	0.447
TPSY227*006#0150	Y	220	6.3	85	4	125	13.9	8	150	1 ¹⁾	0.913	0.822	0.365
TPSC337*006#0080	C	330	6.3	85	4	125	19.8	12	80	1	1.173	1.055	0.469
TPSC337*006#0100	C	330	6.3	85	4	125	19.8	12	100	1	1.049	0.944	0.420
TPSD337*006#0045	D	330	6.3	85	4	125	20.8	8	45	1	1.826	1.643	0.730
TPSD337*006#0050	D	330	6.3	85	4	125	20.8	8	50	1	1.732	1.559	0.693
TPSD337*006#0070	D	330	6.3	85	4	125	20.8	8	70	1	1.464	1.317	0.586
TPSD337*006#0100	D	330	6.3	85	4	125	20.8	8	100	1	1.225	1.102	0.490
TPSE337*006#0050	E	330	6.3	85	4	125	20.8	8	50	1 ¹⁾	1.817	1.635	0.727
TPSE337*006#0100	E	330	6.3	85	4	125	20.8	8	100	1 ¹⁾	1.285	1.156	0.514

RATINGS & PART NUMBER REFERENCE

AVX Part No.	Case Size	Capacitance (μF)	Rated Voltage (V)	Rated Temperature (°C)	Category Voltage (V)	Category Temperature (°C)	DCL Max. (μA)	DF Max. (%)	ESR Max. @ 100kHz (mΩ)	MSL	100kHz RMS Current (A)		
											25°C	85°C	125°C
TPSE337*006#0125	E	330	6.3	85	4	125	20.8	8	125	1 ¹⁾	1.149	1.034	0.460
TPSE337*006#0150	E	330	6.3	85	4	125	20.8	8	150	1 ¹⁾	1.049	0.944	0.420
TPSV337*006#0100	V	330	6.3	85	4	125	20.8	8	100	1 ¹⁾	1.581	1.423	0.632
TPSY337*006#0075	Y	330	6.3	85	4	125	20.8	12	75	1 ¹⁾	1.291	1.162	0.516
TPSY337*006#0100	Y	330	6.3	85	4	125	20.8	12	100	1 ¹⁾	1.118	1.006	0.447
TPSY337*006#0150	Y	330	6.3	85	4	125	20.8	12	150	1 ¹⁾	0.913	0.822	0.365
TPSD477*006#0045	D	470	6.3	85	4	125	28	12	45	1	1.826	1.643	0.730
TPSD477*006#0060	D	470	6.3	85	4	125	28	12	60	1	1.581	1.423	0.632
TPSD477*006#0100	D	470	6.3	85	4	125	28	12	100	1	1.225	1.102	0.490
TPSD477*006#0200	D	470	6.3	85	4	125	28	12	200	1	0.866	0.779	0.346
TPSE477*006#0045	E	470	6.3	85	4	125	28	10	45	1 ¹⁾	1.915	1.723	0.766
TPSE477*006#0050	E	470	6.3	85	4	125	28	10	50	1 ¹⁾	1.817	1.635	0.727
TPSE477*006#0060	E	470	6.3	85	4	125	28	10	60	1 ¹⁾	1.658	1.492	0.663
TPSE477*006#0100	E	470	6.3	85	4	125	28	10	100	1 ¹⁾	1.285	1.156	0.514
TPSE477*006#0200	E	470	6.3	85	4	125	28	10	200	1 ¹⁾	0.908	0.817	0.363
TPSV477*006#0040	V	470	6.3	85	4	125	28	10	40	1 ¹⁾	2.500	2.250	1.000
TPSV477*006#0055	V	470	6.3	85	4	125	28	10	55	1 ¹⁾	2.132	1.919	0.853
TPSV477*006#0100	V	470	6.3	85	4	125	28	10	100	1 ¹⁾	1.581	1.423	0.632
TPSY477*006#0150	Y	470	6.3	85	4	125	28.2	20	150	1 ¹⁾	0.913	0.822	0.365
TPSE687*006#0045	E	680	6.3	85	4	125	42.8	10	45	1 ¹⁾	1.915	1.723	0.766
TPSE687*006#0060	E	680	6.3	85	4	125	42.8	10	60	1 ¹⁾	1.658	1.492	0.663
TPSE687*006#0100	E	680	6.3	85	4	125	42.8	10	100	1 ¹⁾	1.285	1.156	0.514
TPSV687*006#0035	V	680	6.3	85	4	125	42.8	14	35	1 ¹⁾	2.673	2.405	1.069
TPSV687*006#0040	V	680	6.3	85	4	125	42.8	10	40	1 ¹⁾	2.500	2.250	1.000
TPSV687*006#0050	V	680	6.3	85	4	125	42.8	10	50	1 ¹⁾	2.236	2.012	0.894
TPSE108M006#0100	E	1000	6.3	85	4	125	60	20	100	1 ¹⁾	1.285	1.156	0.514
TPSV108M006#0040	V	1000	6.3	85	4	125	60	16	40	1 ¹⁾	2.500	2.250	1.000
TPSV108M006#0050	V	1000	6.3	85	4	125	60	16	50	1 ¹⁾	2.236	2.012	0.894
10 Volt @ 85°C													
TPSR105*010#9000	R	1	10	85	7	125	0.5	4	9000	1	0.078	0.070	0.031
TPSA225*010#1800	A	2.2	10	85	7	125	0.5	6	1800	1	0.204	0.184	0.082
TPST335*010#1500	T	3.3	10	85	7	125	0.5	6	1500	1	0.231	0.208	0.092
TPSA475*010#1400	A	4.7	10	85	7	125	0.5	6	1400	1	0.231	0.208	0.093
TPSB475*010#1400	B	4.7	10	85	7	125	0.5	6	1400	1	0.246	0.222	0.099
TPSR475*010#3000	R	4.7	10	85	7	125	0.5	6	3000	1	0.135	0.122	0.054
TPSR475*010#5000	R	4.7	10	85	7	125	0.5	6	5000	1	0.105	0.094	0.042
TPSA685*010#1800	A	6.8	10	85	7	125	0.7	6	1800	1	0.204	0.184	0.082
TPSB685*010#1300	B	6.8	10	85	7	125	0.7	6	1300	1	0.256	0.230	0.102
TPST685*010#1800	T	6.8	10	85	7	125	0.7	6	1800	1	0.211	0.190	0.084
TPSA106*010#0900	A	10	10	85	7	125	1	6	900	1	0.289	0.260	0.115
TPSA106*010#1800	A	10	10	85	7	125	1	6	1800	1	0.204	0.184	0.082
TPSB106*010#1000	B	10	10	85	7	125	1	6	1000	1	0.292	0.262	0.117
TPSP106M010#2000	P	10	10	85	7	125	1	8	2000	1	0.173	0.156	0.069
TPSS106*010#0900	S	10	10	85	7	125	1	8	900	1	0.269	0.242	0.107
TPST106*010#1000	T	10	10	85	7	125	1	6	1000	1	0.283	0.255	0.113
TPST106*010#2000	T	10	10	85	7	125	1	6	2000	1	0.200	0.180	0.080
TPSA156*010#1000	A	15	10	85	7	125	1.5	6	1000	1	0.274	0.246	0.110
TPSB156*010#0450	B	15	10	85	7	125	1.5	6	450	1	0.435	0.391	0.174
TPSB156*010#0600	B	15	10	85	7	125	1.5	6	600	1	0.376	0.339	0.151
TPSC156*010#0700	C	15	10	85	7	125	1.5	6	700	1	0.396	0.357	0.159
TPST156*010#1200	T	15	10	85	7	125	1.5	8	1200	1	0.258	0.232	0.103
TPSA226*010#0900	A	22	10	85	7	125	2.2	8	900	1	0.289	0.260	0.115
TPSB226*010#0400	B	22	10	85	7	125	2.2	6	400	1	0.461	0.415	0.184
TPSB226*010#0500	B	22	10	85	7	125	2.2	6	500	1	0.412	0.371	0.165
TPSB226*010#0700	B	22	10	85	7	125	2.2	6	700	1	0.348	0.314	0.139
TPSC226*010#0300	C	22	10	85	7	125	2.2	6	300	1	0.606	0.545	0.242
TPST226*010#0800	T	22	10	85	7	125	2.2	8	800	1	0.316	0.285	0.126
TPSA336*010#0700	A	33	10	85	7	125	3.3	8	700	1	0.327	0.295	0.131
TPSB336*010#0250	B	33	10	85	7	125	3.3	6	250	1	0.583	0.525	0.233
TPSB336*010#0425	B	33	10	85	7	125	3.3	6	425	1	0.447	0.402	0.179
TPSB336*010#0500	B	33	10	85	7	125	3.3	6	500	1	0.412	0.371	0.165
TPSB336*010#0650	B	33	10	85	7	125	3.3	6	650	1	0.362	0.325	0.145
TPSC336*010#0150	C	33	10	85	7	125	3.3	6	150	1	0.856	0.771	0.343
TPSC336*010#0375	C	33	10	85	7	125	3.3	6	375	1	0.542	0.487	0.217
TPSC336*010#0500	C	33	10	85	7	125	3.3	6	500	1	0.469	0.422	0.188
TPSW336*010#0350	W	33	10	85	7	125	3.3	6	350	1	0.507	0.456	0.203
TPSB476*010#0250	B	47	10	85	7	125	4.7	8	250	1	0.583	0.525	0.233
TPSB476*010#0350	B	47	10	85	7	125	4.7	8	350	1	0.493	0.444	0.197
TPSB476*010#0500	B	47	10	85	7	125	4.7	8	500	1	0.412	0.371	0.165
TPSB476*010#0650	B	47	10	85	7	125	4.7	8	650	1	0.362	0.325	0.145
TPSC476*010#0200	C	47	10	85	7	125	4.7	6	200	1	0.742	0.667	0.297

RATINGS & PART NUMBER REFERENCE

AVX Part No.	Case Size	Capacitance (µF)	Rated Voltage (V)	Rated Temperature (°C)	Category Voltage (V)	Category Temperature (°C)	DCL Max. (µA)	DF Max. (%)	ESR Max. @ 100kHz (mΩ)	MSL	100kHz RMS Current (A)		
											25°C	85°C	125°C
TPSC476*010#0350	C	47	10	85	7	125	4.7	6	350	1	0.561	0.505	0.224
TPSD476*010#0100	D	47	10	85	7	125	4.7	6	100	1	1.225	1.102	0.490
TPSD476*010#0300	D	47	10	85	7	125	4.7	6	300	1	0.707	0.636	0.283
TPSW476*010#0125	W	47	10	85	7	125	4.7	6	125	1	0.849	0.764	0.339
TPSW476*010#0150	W	47	10	85	7	125	4.7	6	150	1	0.775	0.697	0.310
TPSW476*010#0250	W	47	10	85	7	125	4.7	6	250	1	0.600	0.540	0.240
TPSB686*010#0600	B	68	10	85	7	125	6.8	8	600	1	0.376	0.339	0.151
TPSC686*010#0080	C	68	10	85	7	125	6.8	6	80	1	1.173	1.055	0.469
TPSC686*010#0100	C	68	10	85	7	125	6.8	6	100	1	1.049	0.944	0.420
TPSC686*010#0200	C	68	10	85	7	125	6.8	6	200	1	0.742	0.667	0.297
TPSC686*010#0300	C	68	10	85	7	125	6.8	6	300	1	0.606	0.545	0.242
TPSD686*010#0100	D	68	10	85	7	125	6.8	6	100	1	1.225	1.102	0.490
TPSD686*010#0150	D	68	10	85	7	125	6.8	6	150	1	1.000	0.900	0.400
TPSY686*010#0100	Y	68	10	85	7	125	6.8	6	100	1 ¹⁾	1.118	1.006	0.447
TPSY686*010#0200	Y	68	10	85	7	125	6.8	6	200	1 ¹⁾	0.791	0.712	0.316
TPSW686*010#0100	W	68	10	85	7	125	6.8	6	100	1	0.949	0.854	0.379
TPSW686*010#0150	W	68	10	85	7	125	6.8	6	150	1	0.775	0.697	0.310
TPSB107*010#0400	B	100	10	85	7	125	10	8	400	1	0.461	0.415	0.184
TPSC107*010#0075	C	100	10	85	7	125	10	8	75	1	1.211	1.090	0.484
TPSC107*010#0100	C	100	10	85	7	125	10	8	100	1	1.049	0.944	0.420
TPSC107*010#0150	C	100	10	85	7	125	10	8	150	1	0.856	0.771	0.343
TPSC107*010#0200	C	100	10	85	7	125	10	8	200	1	0.742	0.667	0.297
TPSD107*010#0050	D	100	10	85	7	125	10	6	50	1	1.732	1.559	0.693
TPSD107*010#0065	D	100	10	85	7	125	10	6	65	1	1.519	1.367	0.608
TPSD107*010#0080	D	100	10	85	7	125	10	6	80	1	1.369	1.232	0.548
TPSD107*010#0100	D	100	10	85	7	125	10	6	100	1	1.225	1.102	0.490
TPSD107*010#0125	D	100	10	85	7	125	10	6	125	1	1.095	0.986	0.438
TPSD107*010#0150	D	100	10	85	7	125	10	6	150	1	1.000	0.900	0.400
TPSE107*010#0125	E	100	10	85	7	125	10	6	125	1 ¹⁾	1.149	1.034	0.460
TPSW107*010#0150	W	100	10	85	7	125	10	6	150	1	0.775	0.697	0.310
TPSX107*010#0085	X	100	10	85	7	125	10	8	85	1 ¹⁾	1.085	0.976	0.434
TPSX107*010#0150	X	100	10	85	7	125	10	8	150	1 ¹⁾	0.816	0.735	0.327
TPSX107*010#0200	X	100	10	85	7	125	10	8	200	1 ¹⁾	0.707	0.636	0.283
TPSY107*010#0100	Y	100	10	85	7	125	10	6	100	1 ¹⁾	1.118	1.006	0.447
TPSY107*010#0150	Y	100	10	85	7	125	10	6	150	1 ¹⁾	0.913	0.822	0.365
TPSY107*010#0200	Y	100	10	85	7	125	10	6	200	1 ¹⁾	0.791	0.712	0.316
TPSC157*010#0150	C	150	10	85	7	125	15	8	150	1	0.856	0.771	0.343
TPSD157*010#0050	D	150	10	85	7	125	15	8	50	1	1.732	1.559	0.693
TPSD157*010#0085	D	150	10	85	7	125	15	8	85	1	1.328	1.196	0.531
TPSD157*010#0100	D	150	10	85	7	125	15	8	100	1	1.225	1.102	0.490
TPSE157*010#0100	E	150	10	85	7	125	15	8	100	1 ¹⁾	1.285	1.156	0.514
TPSF157*010#0200	F	150	10	85	7	125	15	10	200	1	0.707	0.636	0.283
TPSX157*010#0100	X	150	10	85	7	125	15	6	100	1 ¹⁾	1.000	0.900	0.400
TPSY157*010#0100	Y	150	10	85	7	125	15	6	100	1 ¹⁾	1.118	1.006	0.447
TPSY157*010#0150	Y	150	10	85	7	125	15	6	150	1 ¹⁾	0.913	0.822	0.365
TPSY157*010#0200	Y	150	10	85	7	125	15	6	200	1 ¹⁾	0.791	0.712	0.316
TPSD227*010#0040	D	220	10	85	7	125	22	8	40	1	1.936	1.743	0.775
TPSD227*010#0050	D	220	10	85	7	125	22	8	50	1	1.732	1.559	0.693
TPSD227*010#0100	D	220	10	85	7	125	22	8	100	1	1.225	1.102	0.490
TPSD227*010#0150	D	220	10	85	7	125	22	8	150	1	1.000	0.900	0.400
TPSE227*010#0050	E	220	10	85	7	125	22	8	50	1 ¹⁾	1.817	1.635	0.727
TPSE227*010#0060	E	220	10	85	7	125	22	8	60	1 ¹⁾	1.658	1.492	0.663
TPSE227*010#0070	E	220	10	85	7	125	22	8	70	1 ¹⁾	1.535	1.382	0.614
TPSE227*010#0100	E	220	10	85	7	125	22	8	100	1 ¹⁾	1.285	1.156	0.514
TPSE227*010#0125	E	220	10	85	7	125	22	8	125	1 ¹⁾	1.149	1.034	0.460
TPSE227*010#0150	E	220	10	85	7	125	22	8	150	1 ¹⁾	1.049	0.944	0.420
TPSY227*010#0100	Y	220	10	85	7	125	22	10	100	1 ¹⁾	1.118	1.006	0.447
TPSY227*010#0150	Y	220	10	85	7	125	22	10	150	1 ¹⁾	0.913	0.822	0.365
TPSY227*010#0200	Y	220	10	85	7	125	22	10	200	1 ¹⁾	0.791	0.712	0.316
TPSD337*010#0050	D	330	10	85	7	125	33	8	50	1	1.732	1.559	0.693
TPSD337*010#0065	D	330	10	85	7	125	33	8	65	1	1.519	1.367	0.608
TPSD337*010#0100	D	330	10	85	7	125	33	8	100	1	1.225	1.102	0.490
TPSD337*010#0150	D	330	10	85	7	125	33	8	150	1	1.000	0.900	0.400
TPSE337*010#0040	E	330	10	85	7	125	33	8	40	1 ¹⁾	2.031	1.828	0.812
TPSE337*010#0050	E	330	10	85	7	125	33	8	50	1 ¹⁾	1.817	1.635	0.727
TPSE337*010#0060	E	330	10	85	7	125	33	8	60	1 ¹⁾	1.658	1.492	0.663
TPSE337*010#0100	E	330	10	85	7	125	33	8	100	1 ¹⁾	1.285	1.156	0.514
TPSV337*010#0040	V	330	10	85	7	125	33	10	40	1 ¹⁾	2.500	2.250	1.000
TPSV337*010#0060	V	330	10	85	7	125	33	10	60	1 ¹⁾	2.041	1.837	0.816
TPSV337*010#0100	V	330	10	85	7	125	33	10	100	1 ¹⁾	1.581	1.423	0.632
TPSE477*010#0045	E	470	10	85	7	125	47	10	45	1 ¹⁾	1.915	1.723	0.766
TPSE477*010#0050	E	470	10	85	7	125	47	10	50	1 ¹⁾	1.817	1.635	0.727

TPS Series



Low ESR

RATINGS & PART NUMBER REFERENCE

AVX Part No.	Case Size	Capacitance (μF)	Rated Voltage (V)	Rated Temperature (°C)	Category Voltage (V)	Category Temperature (°C)	DCL Max. (μA)	DF Max. (%)	ESR Max. @ 100kHz (mΩ)	MSL	100kHz RMS Current (A)		
											25°C	85°C	125°C
TPSE477*010#0060	E	470	10	85	7	125	47	10	60	1 ¹⁾	1.658	1.492	0.663
TPSE477*010#0100	E	470	10	85	7	125	47	10	100	1 ¹⁾	1.285	1.156	0.514
TPSE477*010#0200	E	470	10	85	7	125	47	10	200	1 ¹⁾	0.908	0.817	0.363
TPSV477*010#0040	V	470	10	85	7	125	47	10	40	1 ¹⁾	2.500	2.250	1.000
TPSV477*010#0060	V	470	10	85	7	125	47	10	60	1 ¹⁾	2.041	1.837	0.816
TPSV477*010#0100	V	470	10	85	7	125	47	10	100	1 ¹⁾	1.581	1.423	0.632
TPSE687M010#0150V	E	680	10	85	7	125	68	18	150	3	1.049	0.944	0.420
TPSV687M010#0100V	V	680	10	85	7	125	68	18	100	3	1.581	1.423	0.632
16 Volt @ 85°C													
TPSA105*016#6200	A	1	16	85	10	125	0.5	4	6200	1	0.110	0.099	0.044
TPSA225*016#1800	A	2.2	16	85	10	125	0.5	6	1800	1	0.204	0.184	0.082
TPSA225*016#3500	A	2.2	16	85	10	125	0.5	6	3500	1	0.146	0.132	0.059
TPST225*016#2000	T	2.2	16	85	10	125	0.5	6	2000	1	0.200	0.180	0.080
TPSA335*016#3500	A	3.3	16	85	10	125	0.5	6	3500	1	0.146	0.132	0.059
TPSB335*016#2500	B	3.3	16	85	10	125	0.5	6	2500	1	0.184	0.166	0.074
TPSA475*016#2000	A	4.7	16	85	10	125	0.8	6	2000	1	0.194	0.174	0.077
TPSB475*016#0800	B	4.7	16	85	10	125	0.8	6	800	1	0.326	0.293	0.130
TPSB475*016#1500	B	4.7	16	85	10	125	0.8	6	1500	1	0.238	0.214	0.095
TPSA685*016#1500	A	6.8	16	85	10	125	1.1	6	1500	1	0.224	0.201	0.089
TPSB685*016#0600	B	6.8	16	85	10	125	1.1	6	600	1	0.376	0.339	0.151
TPSB685*016#1200	B	6.8	16	85	10	125	1.1	6	1200	1	0.266	0.240	0.106
TPSA106*016#1000	A	10	16	85	10	125	1.6	6	1000	1	0.274	0.246	0.110
TPSB106*016#0500	B	10	16	85	10	125	1.6	6	500	1	0.412	0.371	0.165
TPSB106*016#0800	B	10	16	85	10	125	1.6	6	800	1	0.326	0.293	0.130
TPSC106*016#0500	C	10	16	85	10	125	1.6	6	500	1	0.469	0.422	0.188
TPST106*016#0800	T	10	16	85	10	125	1.6	8	800	1	0.316	0.285	0.126
TPST106*016#1000	T	10	16	85	10	125	1.6	8	1000	1	0.283	0.255	0.113
TPSW106*016#0500	W	10	16	85	10	125	1.6	6	500	1	0.424	0.382	0.170
TPSW106*016#0600	W	10	16	85	10	125	1.6	6	600	1	0.387	0.349	0.155
TPSB156*016#0500	B	15	16	85	10	125	2.4	6	500	1	0.412	0.371	0.165
TPSB156*016#0800	B	15	16	85	10	125	2.4	6	800	1	0.326	0.293	0.130
TPSC156*016#0300	C	15	16	85	10	125	2.4	6	300	1	0.606	0.545	0.242
TPSC156*016#0700	C	15	16	85	10	125	2.4	6	700	1	0.396	0.357	0.159
TPSB226*016#0400	B	22	16	85	10	125	3.5	6	400	1	0.461	0.415	0.184
TPSB226*016#0600	B	22	16	85	10	125	3.5	6	600	1	0.376	0.339	0.151
TPSC226*016#0150	C	22	16	85	10	125	3.5	6	150	1	0.856	0.771	0.343
TPSC226*016#0250	C	22	16	85	10	125	3.5	6	250	1	0.663	0.597	0.265
TPSC226*016#0300	C	22	16	85	10	125	3.5	6	300	1	0.606	0.545	0.242
TPSC226*016#0375	C	22	16	85	10	125	3.5	6	375	1	0.542	0.487	0.217
TPSD226*016#0700	D	22	16	85	10	125	3.5	6	700	1	0.463	0.417	0.185
TPSW226*016#0500	W	22	16	85	10	125	3.5	6	500	1	0.424	0.382	0.170
TPSB336*016#0350	B	33	16	85	10	125	5.3	8	350	1	0.493	0.444	0.197
TPSB336*016#0500	B	33	16	85	10	125	5.3	8	500	1	0.412	0.371	0.165
TPSC336*016#0100	C	33	16	85	10	125	5.3	6	100	1	1.049	0.944	0.420
TPSC336*016#0150	C	33	16	85	10	125	5.3	6	150	1	0.856	0.771	0.343
TPSC336*016#0225	C	33	16	85	10	125	5.3	6	225	1	0.699	0.629	0.280
TPSC336*016#0300	C	33	16	85	10	125	5.3	6	300	1	0.606	0.545	0.242
TPSD336*016#0200	D	33	16	85	10	125	5.3	6	200	1	0.866	0.779	0.346
TPSW336*016#0140	W	33	16	85	10	125	5.3	6	140	1	0.802	0.722	0.321
TPSW336*016#0175	W	33	16	85	10	125	5.3	6	175	1	0.717	0.645	0.287
TPSW336*016#0250	W	33	16	85	10	125	5.3	6	250	1	0.600	0.540	0.240
TPSW336*016#0400	W	33	16	85	10	125	5.3	6	400	1	0.474	0.427	0.190
TPSW336*016#0500	W	33	16	85	10	125	5.3	6	500	1	0.424	0.382	0.170
TPSY336*016#0300	Y	33	16	85	10	125	5.3	6	300	1 ¹⁾	0.645	0.581	0.258
TPSY336*016#0400	Y	33	16	85	10	125	5.3	6	400	1 ¹⁾	0.559	0.503	0.224
TPSD476*016#0110	C	47	16	85	10	125	7.5	6	110	1	1.000	0.900	0.400
TPSC476*016#0350	C	47	16	85	10	125	7.5	6	350	1	0.561	0.505	0.224
TPSD476*016#0080	D	47	16	85	10	125	7.5	6	80	1	1.369	1.232	0.548
TPSD476*016#0100	D	47	16	85	10	125	7.5	6	100	1	1.225	1.102	0.490
TPSD476*016#0150	D	47	16	85	10	125	7.5	6	150	1	1.000	0.900	0.400
TPSD476*016#0200	D	47	16	85	10	125	7.5	6	200	1	0.866	0.779	0.346
TPSW476*016#0200	W	47	16	85	10	125	7.5	6	200	1	0.671	0.604	0.268
TPSX476*016#0180	X	47	16	85	10	125	7.5	6	180	1 ¹⁾	0.745	0.671	0.298
TPSY476*016#0250	Y	47	16	85	10	125	7.5	6	250	1 ¹⁾	0.707	0.636	0.283
TPSC686*016#0125	C	68	16	85	10	125	10.9	6	125	1	0.938	0.844	0.375
TPSC686*016#0200	C	68	16	85	10	125	10.9	6	200	1	0.742	0.667	0.297
TPSD686*016#0070	D	68	16	85	10	125	10.9	6	70	1	1.464	1.317	0.586
TPSD686*016#0100	D	68	16	85	10	125	10.9	6	100	1	1.225	1.102	0.490
TPSD686*016#0150	D	68	16	85	10	125	10.9	6	150	1	1.000	0.900	0.400
TPSF686*016#0200	F	68	16	85	10	125	10.9	10	200	1	0.707	0.636	0.283
TPSX686*016#0150	X	68	16	85	10	125	10.9	8	150	1 ¹⁾	0.816	0.735	0.327
TPSY686*016#0150	Y	68	16	85	10	125	10.9	6	150	1 ¹⁾	0.913	0.822	0.365

RATINGS & PART NUMBER REFERENCE

AVX Part No.	Case Size	Capacitance (µF)	Rated Voltage (V)	Rated Temperature (°C)	Category Voltage (V)	Category Temperature (°C)	DCL Max. (µA)	DF Max. (%)	ESR Max. @ 100kHz (mΩ)	MSL	100kHz RMS Current (A)		
											25°C	85°C	125°C
TPSY686*016#0200	Y	68	16	85	10	125	10.9	6	200	1 ¹⁾	0.791	0.712	0.316
TPSY686*016#0250	Y	68	16	85	10	125	10.9	6	250	1 ¹⁾	0.707	0.636	0.283
TPSC107*016#0200	C	100	16	85	10	125	16	8	200	1	0.742	0.667	0.297
TPSD107*016#0060	D	100	16	85	10	125	16	6	60	1	1.581	1.423	0.632
TPSD107*016#0100	D	100	16	85	10	125	16	6	100	1	1.225	1.102	0.490
TPSD107*016#0125	D	100	16	85	10	125	16	6	125	1	1.095	0.986	0.438
TPSD107*016#0150	D	100	16	85	10	125	16	6	150	1	1.000	0.900	0.400
TPSE107*016#0055	E	100	16	85	10	125	16	6	55	1 ¹⁾	1.732	1.559	0.693
TPSE107*016#0100	E	100	16	85	10	125	16	6	100	1 ¹⁾	1.285	1.156	0.514
TPSE107*016#0125	E	100	16	85	10	125	16	6	125	1 ¹⁾	1.149	1.034	0.460
TPSE107*016#0150	E	100	16	85	10	125	16	6	150	1 ¹⁾	1.049	0.944	0.420
TPSF107M016#0150	F	100	16	85	10	125	16	10	150	1	0.816	0.735	0.327
TPSF107M016#0200	F	100	16	85	10	125	16	10	200	1	0.707	0.636	0.283
TPSY107*016#0100	Y	100	16	85	10	125	16	8	100	1 ¹⁾	1.118	1.006	0.447
TPSY107*016#0150	Y	100	16	85	10	125	16	8	150	1 ¹⁾	0.913	0.822	0.365
TPSY107*016#0200	Y	100	16	85	10	125	16	8	200	1 ¹⁾	0.791	0.712	0.316
TPSD157*016#0060	D	150	16	85	10	125	24	6	60	1	1.581	1.423	0.632
TPSD157*016#0085	D	150	16	85	10	125	24	6	85	1	1.328	1.196	0.531
TPSD157*016#0100	D	150	16	85	10	125	24	6	100	1	1.225	1.102	0.490
TPSD157*016#0125	D	150	16	85	10	125	24	6	125	1	1.095	0.986	0.438
TPSD157*016#0150	D	150	16	85	10	125	23	8	150	1	1.000	0.900	0.400
TPSE157*016#0100	E	150	16	85	10	125	24	6	100	1 ¹⁾	1.285	1.156	0.514
TPSV157*016#0045	V	150	16	85	10	125	24	8	45	1 ¹⁾	2.357	2.121	0.943
TPSV157*016#0075	V	150	16	85	10	125	24	8	75	1 ¹⁾	1.826	1.643	0.730
TPSY157M016#0200	Y	150	16	85	10	125	24	15	200	1 ¹⁾	0.791	0.712	0.316
TPSE227*016#0100	E	220	16	85	10	125	35.2	10	100	1 ¹⁾	1.285	1.156	0.514
TPSE227*016#0150	E	220	16	85	10	125	35.2	10	150	1 ¹⁾	1.049	0.944	0.420
TPSV227*016#0050	V	220	16	85	10	125	35.2	8	50	1 ¹⁾	2.236	2.012	0.894
TPSV227*016#0075	V	220	16	85	10	125	35.2	8	75	1 ¹⁾	1.826	1.643	0.730
TPSV227*016#0100	V	220	16	85	10	125	35.2	8	100	1 ¹⁾	1.581	1.423	0.632
TPSV227*016#0150	V	220	16	85	10	125	35.2	8	150	1 ¹⁾	1.291	1.162	0.516
TPSE337M016#0200	E	330	16	85	10	125	52.8	30	200	1 ¹⁾	0.908	0.817	0.363
20 Volt @ 85°C													
TPSA105*020#3000	A	1	20	85	13	125	0.5	4	3000	1	0.158	0.142	0.063
TPSR105*020#6000	R	1	20	85	13	125	0.5	4	6000	1	0.096	0.086	0.038
TPSS105*020#6000	S	1	20	85	13	125	0.5	4	6000	1	0.104	0.094	0.042
TPST105*020#2000	T	1	20	85	13	125	0.5	4	2000	1	0.200	0.180	0.080
TPSA155*020#3000	A	1.5	20	85	13	125	0.5	6	3000	1	0.158	0.142	0.063
TPSA225*020#3000	A	2.2	20	85	13	125	0.5	6	3000	1	0.158	0.142	0.063
TPSB225*020#1700	B	2.2	20	85	13	125	0.5	6	1700	1	0.224	0.201	0.089
TPSA335*020#2500	A	3.3	20	85	13	125	0.7	6	2500	1	0.173	0.156	0.069
TPSB335*020#1300	B	3.3	20	85	13	125	0.7	6	1300	1	0.256	0.230	0.102
TPSA475*020#1800	A	4.7	20	85	13	125	0.9	6	1800	1	0.204	0.184	0.082
TPSB475*020#0750	B	4.7	20	85	13	125	0.9	6	750	1	0.337	0.303	0.135
TPSB475*020#1000	B	4.7	20	85	13	125	0.9	6	1000	1	0.292	0.262	0.117
TPSA685*020#1000	A	6.8	20	85	13	125	1.4	6	1000	1	0.274	0.246	0.110
TPSB685*020#0600	B	6.8	20	85	13	125	1.4	6	600	1	0.376	0.339	0.151
TPSB685*020#1000	B	6.8	20	85	13	125	1.4	6	1000	1	0.292	0.262	0.117
TPSC685*020#0700	C	6.8	20	85	13	125	1.4	6	700	1	0.396	0.357	0.159
TPSB106*020#0500	B	10	20	85	13	125	2	6	500	1	0.412	0.371	0.165
TPSB106*020#1000	B	10	20	85	13	125	2	6	1000	1	0.292	0.262	0.117
TPSC106*020#0500	C	10	20	85	13	125	2	6	500	1	0.469	0.422	0.188
TPSC106*020#0700	C	10	20	85	13	125	2	6	700	1	0.396	0.357	0.159
TPSW106*020#0250	W	10	20	85	13	125	2	6	250	1	0.600	0.540	0.240
TPSW106*020#0500	W	10	20	85	13	125	2	6	500	1	0.424	0.382	0.170
TPSB156*020#0500	B	15	20	85	13	125	3	6	500	1	0.412	0.371	0.165
TPSC156*020#0400	C	15	20	85	13	125	3	6	400	1	0.524	0.472	0.210
TPSC156*020#0450	C	15	20	85	13	125	3	6	450	1	0.494	0.445	0.198
TPSB226*020#0400	B	22	20	85	13	125	4.4	6	400	1	0.461	0.415	0.184
TPSB226*020#0600	B	22	20	85	13	125	4.4	6	600	1	0.376	0.339	0.151
TPSC226*020#0100	C	22	20	85	13	125	4.4	6	100	1	1.049	0.944	0.420
TPSC226*020#0150	C	22	20	85	13	125	4.4	6	150	1	0.856	0.771	0.343
TPSC226*020#0400	C	22	20	85	13	125	4.4	6	400	1	0.524	0.472	0.210
TPSD226*020#0200	D	22	20	85	13	125	4.4	6	200	1	0.866	0.779	0.346
TPSD226*020#0300	D	22	20	85	13	125	4.4	6	300	1	0.707	0.636	0.283
TPSC336*020#0300	C	33	20	85	13	125	6.6	6	300	1	0.606	0.545	0.242
TPSD336*020#0100	D	33	20	85	13	125	6.6	6	100	1	1.225	1.102	0.490
TPSD336*020#0200	D	33	20	85	13	125	6.6	6	200	1	0.866	0.779	0.346
TPSD476*020#0075	D	47	20	85	13	125	9.4	6	75	1	1.414	1.273	0.566
TPSD476*020#0100	D	47	20	85	13	125	9.4	6	100	1	1.225	1.102	0.490
TPSD476*020#0200	D	47	20	85	13	125	9.4	6	200	1	0.866	0.779	0.346

TPS Series



Low ESR

RATINGS & PART NUMBER REFERENCE

AVX Part No.	Case Size	Capacitance (μF)	Rated Voltage (V)	Rated Temperature (°C)	Category Voltage (V)	Category Temperature (°C)	DCL Max. (μA)	DF Max. (%)	ESR Max. @ 100kHz (mΩ)	MSL	100kHz RMS Current (A)		
											25°C	85°C	125°C
TPSE476*020#0070	E	47	20	85	13	125	9.4	6	70	1 ¹⁾	1.535	1.382	0.614
TPSE476*020#0125	E	47	20	85	13	125	9.4	6	125	1 ¹⁾	1.149	1.034	0.460
TPSE476*020#0150	E	47	20	85	13	125	9.4	6	150	1 ¹⁾	1.049	0.944	0.420
TPSE476*020#0200	E	47	20	85	13	125	9.4	6	200	1 ¹⁾	0.908	0.817	0.363
TPSE476*020#0250	E	47	20	85	13	125	9.4	6	250	1 ¹⁾	0.812	0.731	0.325
TPSX476*020#0200	X	47	20	85	13	125	9.4	6	200	1 ¹⁾	0.707	0.636	0.283
TPSD686*020#0070	D	68	20	85	13	125	13.6	6	70	1	1.464	1.317	0.586
TPSD686*020#0150	D	68	20	85	13	125	13.6	6	150	1	1.000	0.900	0.400
TPSD686*020#0200	D	68	20	85	13	125	13.6	6	200	1	0.866	0.779	0.346
TPSD686*020#0300	D	68	20	85	13	125	13.6	6	300	1	0.707	0.636	0.283
TPSE686*020#0125	E	68	20	85	13	125	13.6	6	125	1 ¹⁾	1.149	1.034	0.460
TPSE686*020#0150	E	68	20	85	13	125	13.6	6	150	1 ¹⁾	1.049	0.944	0.420
TPSE686*020#0200	E	68	20	85	13	125	13.6	6	200	1 ¹⁾	0.908	0.817	0.363
TPSY686*020#0200	Y	68	20	85	13	125	13.6	6	200	1 ¹⁾	0.791	0.712	0.316
TPSD107*020#0085	D	100	20	85	13	125	20	6	85	1	1.328	1.196	0.531
TPSD107*020#0100	D	100	20	85	13	125	20	6	100	1	1.225	1.102	0.490
TPSD107*020#0150	D	100	20	85	13	125	20	6	150	1	1.000	0.900	0.400
TPSE107*020#0100	E	100	20	85	13	125	20	6	100	1 ¹⁾	1.285	1.156	0.514
TPSE107*020#0150	E	100	20	85	13	125	20	6	150	1 ¹⁾	1.049	0.944	0.420
TPSE107*020#0200	E	100	20	85	13	125	20	6	200	1 ¹⁾	0.908	0.817	0.363
TPSV107*020#0060	V	100	20	85	13	125	20	8	60	1 ¹⁾	2.041	1.837	0.816
TPSV107*020#0085	V	100	20	85	13	125	20	8	85	1 ¹⁾	1.715	1.543	0.686
TPSV107*020#0100	V	100	20	85	13	125	20	8	100	1 ¹⁾	1.581	1.423	0.632
TPSV107*020#0200	V	100	20	85	13	125	20	8	200	1 ¹⁾	1.118	1.006	0.447
TPSV157*020#0080	V	150	20	85	13	125	30	8	80	1 ¹⁾	1.768	1.591	0.707
25 Volt @ 85°C													
TPSA474*025#7000	A	0.47	25	85	17	125	0.5	4	7000	1	0.104	0.093	0.041
TPSA684*025#6000	A	0.68	25	85	17	125	0.5	4	6000	1	0.112	0.101	0.045
TPSA105*025#4000	A	1	25	85	17	125	0.5	4	4000	1	0.137	0.123	0.055
TPSR105*025#2500	R	1	25	85	17	125	0.5	4	2500	1	0.148	0.133	0.059
TPSR105*025#4000	R	1	25	85	17	125	0.5	4	4000	1	0.117	0.106	0.047
TPSA155*025#3000	A	1.5	25	85	17	125	0.5	6	3000	1	0.158	0.142	0.063
TPSB155*025#1800	B	1.5	25	85	17	125	0.5	6	1800	1	0.217	0.196	0.087
TPSA225*025#2500	A	2.2	25	85	17	125	0.6	6	2500	1	0.173	0.156	0.069
TPSB225*025#0900	B	2.2	25	85	17	125	0.6	6	900	1	0.307	0.277	0.123
TPSB225*025#1200	B	2.2	25	85	17	125	0.6	6	1200	1	0.266	0.240	0.106
TPSB225*025#2500	B	2.2	25	85	17	125	0.6	6	2500	1	0.184	0.166	0.074
TPSA335*025#1000	A	3.3	25	85	17	125	0.8	6	1000	1	0.274	0.246	0.110
TPSA335*025#1500	A	3.3	25	85	17	125	0.8	6	1500	1	0.224	0.201	0.089
TPSB335*025#0750	B	3.3	25	85	17	125	0.8	6	750	1	0.337	0.303	0.135
TPSB335*025#1500	B	3.3	25	85	17	125	0.8	6	1500	1	0.238	0.214	0.095
TPSB335*025#2000	B	3.3	25	85	17	125	0.8	6	2000	1	0.206	0.186	0.082
TPSB475*025#0700	B	4.7	25	85	17	125	1.2	6	700	1	0.348	0.314	0.139
TPSB475*025#0900	B	4.7	25	85	17	125	1.2	6	900	1	0.307	0.277	0.123
TPSB475*025#1500	B	4.7	25	85	17	125	1.2	6	1500	1	0.238	0.214	0.095
TPSC475*025#0700	C	4.7	25	85	17	125	1.2	6	700	1	0.396	0.357	0.159
TPSB685*025#0700	B	6.8	25	85	17	125	1.7	6	700	1	0.348	0.314	0.139
TPSC685*025#0500	C	6.8	25	85	17	125	1.7	6	500	1	0.469	0.422	0.188
TPSC685*025#0600	C	6.8	25	85	17	125	1.7	6	600	1	0.428	0.385	0.171
TPSC685*025#0700	C	6.8	25	85	17	125	1.7	6	700	1	0.396	0.357	0.159
TPSB106*025#1800	B	10	25	85	17	125	2.5	6	1800	1	0.217	0.196	0.087
TPSC106*025#0300	C	10	25	85	17	125	2.5	6	300	1	0.606	0.545	0.242
TPSC106*025#0500	C	10	25	85	17	125	2.5	6	500	1	0.469	0.422	0.188
TPSD106*025#0500	D	10	25	85	17	125	2.5	6	500	1	0.548	0.493	0.219
TPSC156*025#0220	C	15	25	85	17	125	3.8	6	220	1	0.707	0.636	0.283
TPSC156*025#0300	C	15	25	85	17	125	3.8	6	300	1	0.606	0.545	0.242
TPSD156*025#0100	D	15	25	85	17	125	3.8	6	100	1	1.225	1.102	0.490
TPSD156*025#0300	D	15	25	85	17	125	3.8	6	300	1	0.707	0.636	0.283
TPSC226*025#0275	C	22	25	85	17	125	5.5	6	275	1	0.632	0.569	0.253
TPSC226*025#0400	C	22	25	85	17	125	5.5	6	400	1	0.524	0.472	0.210
TPSD226*025#0100	D	22	25	85	17	125	5.5	6	100	1	1.225	1.102	0.490
TPSD226*025#0200	D	22	25	85	17	125	5.5	6	200	1	0.866	0.779	0.346
TPSD226*025#0300	D	22	25	85	17	125	5.5	6	300	1	0.707	0.636	0.283
TPSF226*025#0300	F	22	25	85	17	125	5.5	6	300	1	0.577	0.520	0.231
TPSC336*025#0400	C	33	25	85	17	125	8.3	6	400	1	0.524	0.472	0.210
TPSD336*025#0100	D	33	25	85	17	125	8.3	6	100	1	1.225	1.102	0.490
TPSD336*025#0200	D	33	25	85	17	125	8.3	6	200	1	0.866	0.779	0.346
TPSD336*025#0300	D	33	25	85	17	125	8.3	6	300	1	0.707	0.636	0.283
TPSE336*025#0100	E	33	25	85	17	125	8.3	6	100	1 ¹⁾	1.285	1.156	0.514
TPSE336*025#0175	E	33	25	85	17	125	8.3	6	175	1 ¹⁾	0.971	0.874	0.388
TPSE336*025#0200	E	33	25	85	17	125	8.3	6	200	1 ¹⁾	0.908	0.817	0.363
TPSE336*025#0300	E	33	25	85	17	125	8.3	6	300	1 ¹⁾	0.742	0.667	0.297



RATINGS & PART NUMBER REFERENCE

AVX Part No.	Case Size	Capacitance (µF)	Rated Voltage (V)	Rated Temperature (°C)	Category Voltage (V)	Category Temperature (°C)	DCL Max. (µA)	DF Max. (%)	ESR Max. @ 100kHz (mΩ)	MSL	100kHz RMS Current (A)		
											25°C	85°C	125°C
TPSY336*025#0200	Y	33	25	85	17	125	8.3	6	200	1 ¹⁾	0.791	0.712	0.316
TPSD476*025#0125	D	47	25	85	17	125	11.8	6	125	1	1.095	0.986	0.438
TPSD476*025#0150	D	47	25	85	17	125	11.8	6	150	1	1.000	0.900	0.400
TPSD476*025#0250	D	47	25	85	17	125	11.8	6	250	1	0.775	0.697	0.310
TPSE476*025#0080	E	47	25	85	17	125	11.8	6	80	1 ¹⁾	1.436	1.293	0.574
TPSE476*025#0100	E	47	25	85	17	125	11.8	6	100	1 ¹⁾	1.285	1.156	0.514
TPSE476*025#0125	E	47	25	85	17	125	11.8	6	125	1 ¹⁾	1.149	1.034	0.460
TPSY476*025#0250	Y	47	25	85	17	125	11.8	6	250	1 ¹⁾	0.707	0.636	0.283
TPSD686*025#0150	D	68	25	85	17	125	17	6	150	1	1.000	0.900	0.400
TPSD686*025#0200	D	68	25	85	17	125	17	6	200	1	0.866	0.779	0.346
TPSD686*025#0300	D	68	25	85	17	125	17	6	300	1	0.707	0.636	0.283
TPSE686*025#0125	E	68	25	85	17	125	17	6	125	1 ¹⁾	1.149	1.034	0.460
TPSE686*025#0200	E	68	25	85	17	125	17	6	200	1 ¹⁾	0.908	0.817	0.363
TPSV686*025#0080	V	68	25	85	17	125	17	6	80	1 ¹⁾	1.768	1.591	0.707
TPSV686*025#0095	V	68	25	85	17	125	17	6	95	1 ¹⁾	1.622	1.460	0.649
TPSV686*025#0150	V	68	25	85	17	125	17	6	150	1 ¹⁾	1.291	1.162	0.516
TPSV686*025#0200	V	68	25	85	17	125	17	6	200	1 ¹⁾	1.118	1.006	0.447
TPSE107*025#0150	E	100	25	85	17	125	25	10	150	1 ¹⁾	1.049	0.944	0.420
TPSV107*025#0100	V	100	25	85	17	125	25	8	100	1 ¹⁾	1.581	1.423	0.632
TPSV157M025#0150	V	150	25	85	17	125	37.5	10	150	1 ¹⁾	1.291	1.162	0.516
35 Volt @ 85°C													
TPSA224*035#6000	A	0.22	35	85	23	125	0.5	4	6000	1	0.112	0.101	0.045
TPSA334*035#6000	A	0.33	35	85	23	125	0.5	4	6000	1	0.112	0.101	0.045
TPSA474*035#6000	A	0.47	35	85	23	125	0.5	4	6000	1	0.112	0.101	0.045
TPSB474*035#4000	B	0.47	35	85	23	125	0.5	4	4000	1	0.146	0.131	0.058
TPSA684*035#6000	A	0.68	35	85	23	125	0.5	4	6000	1	0.112	0.101	0.045
TPSA105*035#3000	A	1	35	85	23	125	0.5	4	3000	1	0.158	0.142	0.063
TPSB105*035#2000	B	1	35	85	23	125	0.5	4	2000	1	0.206	0.186	0.082
TPSA155*035#3000	A	1.5	35	85	23	125	0.5	6	3000	1	0.158	0.142	0.063
TPSB155*035#2500	B	1.5	35	85	23	125	0.5	6	2500	1	0.184	0.166	0.074
TPSA225*035#1500	A	2.2	35	85	23	125	0.8	6	1500	1	0.224	0.201	0.089
TPSB225*035#0750	B	2.2	35	85	23	125	0.8	6	750	1	0.337	0.303	0.135
TPSB225*035#1500	B	2.2	35	85	23	125	0.8	6	1500	1	0.238	0.214	0.095
TPSB225*035#2000	B	2.2	35	85	23	125	0.8	6	2000	1	0.206	0.186	0.082
TPSC225*035#1000	C	2.2	35	85	23	125	0.8	6	1000	1	0.332	0.298	0.133
TPSB335*035#1000	B	3.3	35	85	23	125	1.2	6	1000	1	0.292	0.262	0.117
TPSC335*035#0700	C	3.3	35	85	23	125	1.2	6	700	1	0.396	0.357	0.159
TPSB475*035#0700	B	4.7	35	85	23	125	1.6	6	700	1	0.348	0.314	0.139
TPSB475*035#1500	B	4.7	35	85	23	125	1.6	6	1500	1	0.238	0.214	0.095
TPSC475*035#0600	C	4.7	35	85	23	125	1.6	6	600	1	0.428	0.385	0.171
TPSD475*035#0700	D	4.7	35	85	23	125	1.6	6	700	1	0.463	0.417	0.185
TPSE685*035#0350	C	6.8	35	85	23	125	2.4	6	350	1	0.561	0.505	0.224
TPSD685*035#0150	D	6.8	35	85	23	125	2.4	6	150	1	1.000	0.900	0.400
TPSD685*035#0400	D	6.8	35	85	23	125	2.4	6	400	1	0.612	0.551	0.245
TPSD685*035#0500	D	6.8	35	85	23	125	2.4	6	500	1	0.548	0.493	0.219
TPSC106*035#0600	C	10	35	85	23	125	3.5	6	600	1	0.428	0.385	0.171
TPSD106*035#0125	D	10	35	85	23	125	3.5	6	125	1	1.095	0.986	0.438
TPSD106*035#0300	D	10	35	85	23	125	3.5	6	300	1	0.707	0.636	0.283
TPSE106*035#0200	E	10	35	85	23	125	3.5	6	200	1 ¹⁾	0.908	0.817	0.363
TPSY106*035#0250	Y	10	35	85	23	125	3.5	6	250	1 ¹⁾	0.707	0.636	0.283
TPSC156*035#0350	C	15	35	85	23	125	5.3	6	350	1	0.561	0.505	0.224
TPSC156*035#0450	C	15	35	85	23	125	5.3	6	450	1	0.494	0.445	0.198
TPSD156*035#0100	D	15	35	85	23	125	5.3	6	100	1	1.225	1.102	0.490
TPSD156*035#0300	D	15	35	85	23	125	5.3	6	300	1	0.707	0.636	0.283
TPSY156*035#0250	Y	15	35	85	23	125	5.3	6	250	1 ¹⁾	0.707	0.636	0.283
TPSD226*035#0125	D	22	35	85	23	125	7.7	6	125	1	1.095	0.986	0.438
TPSD226*035#0200	D	22	35	85	23	125	7.7	6	200	1	0.866	0.779	0.346
TPSD226*035#0300	D	22	35	85	23	125	7.7	6	300	1	0.707	0.636	0.283
TPSD226*035#0400	D	22	35	85	23	125	7.7	6	400	1	0.612	0.551	0.245
TPSE226*035#0125	E	22	35	85	23	125	7.7	6	125	1 ¹⁾	1.149	1.034	0.460
TPSE226*035#0200	E	22	35	85	23	125	7.7	6	200	1 ¹⁾	0.908	0.817	0.363
TPSE226*035#0300	E	22	35	85	23	125	7.7	6	300	1 ¹⁾	0.742	0.667	0.297
TPSY226*035#0200	Y	22	35	85	23	125	7.7	6	200	1 ¹⁾	0.791	0.712	0.316
TPSD336*035#0200	D	33	35	85	23	125	11.6	6	200	1	0.866	0.779	0.346
TPSD336*035#0300	D	33	35	85	23	125	11.6	6	300	1	0.707	0.636	0.283
TPSE336*035#0100	E	33	35	85	23	125	11.6	6	100	1 ¹⁾	1.285	1.156	0.514
TPSE336*035#0250	E	33	35	85	23	125	11.6	6	250	1 ¹⁾	0.812	0.731	0.325
TPSE336*035#0300	E	33	35	85	23	125	11.6	6	300	1 ¹⁾	0.742	0.667	0.297
TPSV336*035#0200	V	33	35	85	23	125	11.6	6	200	1 ¹⁾	1.118	1.006	0.447
TPSE476*035#0200	E	47	35	85	23	125	16.5	6	200	1 ¹⁾	0.908	0.817	0.363
TPSE476*035#0250	E	47	35	85	23	125	16.5	6	250	1 ¹⁾	0.812	0.731	0.325
TPSV476*035#0150	V	47	35	85	23	125	16.5	6	150	1 ¹⁾	1.291	1.162	0.516
TPSV476*035#0200	V	47	35	85	23	125	16.5	6	200	1 ¹⁾	1.118	1.006	0.447

RATINGS & PART NUMBER REFERENCE

AVX Part No.	Case Size	Capacitance (µF)	Rated Voltage (V)	Rated Temperature (°C)	Category Voltage (V)	Category Temperature (°C)	DCL Max. (µA)	DF Max. (%)	ESR Max. @ 100kHz (mΩ)	MSL	100kHz RMS Current (A)		
											25°C	85°C	125°C
TPSV686*035#0150	V	68	35	85	23	125	23.8	6	150	1 ¹⁾	1.291	1.162	0.516
TPSV686*035#0200	V	68	35	85	23	125	23.8	6	200	1 ¹⁾	1.118	1.006	0.447
50 Volt @ 85°C													
TPSA154*050#9000	A	0.15	50	85	33	125	0.5	4	9000	1	0.091	0.082	0.037
TPSA224*050#7000	A	0.22	50	85	33	125	0.5	4	7000	1	0.104	0.093	0.041
TPSA334*050#7000	A	0.33	50	85	33	125	0.5	4	7000	1	0.104	0.093	0.041
TPSA474*050#6500	A	0.47	50	85	33	125	0.5	4	6500	1	0.107	0.097	0.043
TPSB474*050#6000	B	0.47	50	85	33	125	0.5	4	6000	1	0.119	0.107	0.048
TPSC474*050#2300	C	0.47	50	85	33	125	0.5	4	2300	1	0.219	0.197	0.087
TPSB684*050#4000	B	0.68	50	85	33	125	0.5	4	4000	1	0.146	0.131	0.058
TPSB105*050#3000	B	1	50	85	33	125	0.5	6	3000	1	0.168	0.151	0.067
TPSC105*050#2500	C	1	50	85	33	125	0.5	4	2500	1	0.210	0.189	0.084
TPSC155*050#1500	C	1.5	50	85	33	125	0.8	6	1500	1	0.271	0.244	0.108
TPSC155*050#2000	C	1.5	50	85	33	125	0.8	6	2000	1	0.235	0.211	0.094
TPSC225*050#1500	C	2.2	50	85	33	125	1.1	8	1500	1	0.271	0.244	0.108
TPSD225*050#1200	D	2.2	50	85	33	125	1.1	6	1200	1	0.354	0.318	0.141
TPSC335*050#1000	C	3.3	50	85	33	125	1.6	6	1000	1	0.332	0.298	0.133
TPSD335*050#0800	D	3.3	50	85	33	125	1.7	6	800	1	0.433	0.390	0.173
TPSC475*050#0800	C	4.7	50	85	33	125	2.4	6	800	1	0.371	0.334	0.148
TPSD475*050#0250	D	4.7	50	85	33	125	2.4	6	250	1	0.775	0.697	0.310
TPSD475*050#0300	D	4.7	50	85	33	125	2.4	6	300	1	0.707	0.636	0.283
TPSD475*050#0500	D	4.7	50	85	33	125	2.4	6	500	1	0.548	0.493	0.219
TPSD475*050#0700	D	4.7	50	85	33	125	2.4	6	700	1	0.463	0.417	0.185
TPSX475*050#0500V	X	4.7	50	85	33	125	2.4	6	500	3	0.447	0.402	0.179
TPSD685*050#0200	D	6.8	50	85	33	125	3.4	6	200	1	0.866	0.779	0.346
TPSD685*050#0300	D	6.8	50	85	33	125	3.4	6	300	1	0.707	0.636	0.283
TPSD685*050#0500	D	6.8	50	85	33	125	3.4	6	500	1	0.548	0.493	0.219
TPSD685*050#0600	D	6.8	50	85	33	125	3.4	6	600	1	0.500	0.450	0.200
TPSD106*050#0500	D	10	50	85	33	125	5	6	500	1	0.548	0.493	0.219
TPSE106*050#0250	E	10	50	85	33	125	5	6	250	1 ¹⁾	0.812	0.731	0.325
TPSE106*050#0300	E	10	50	85	33	125	5	6	300	1 ¹⁾	0.742	0.667	0.297
TPSE106*050#0400	E	10	50	85	33	125	5	6	400	1 ¹⁾	0.642	0.578	0.257
TPSE106*050#0500	E	10	50	85	33	125	5	6	500	1 ¹⁾	0.574	0.517	0.230
TPSE156*050#0250	E	15	50	85	33	125	7.5	6	250	1 ¹⁾	0.812	0.731	0.325
TPSV156*050#0250	V	15	50	85	33	125	7.5	6	250	1 ¹⁾	1.000	0.900	0.400

1¹⁾ -Dry pack option (see How to order) is recommended for reduction of stress during soldering. Dry pack parts should be treated as MSL 3.

For AEC-Q200 availability, please contact AVX.

Moisture Sensitivity Level (MSL) is defined according to J-STD-020

All technical data relates to an ambient temperature of +25°C. Capacitance and DF are measured at 120Hz, 0.5V RMS with a maximum DC bias of 2.2 volts.

DCL is measured at rated voltage after 5 minutes.

The EIA & CECC standards for low ESR Solid Tantalum Capacitors allow an ESR movement to 1.25 times catalogue limit post mounting.

For typical weight and composition see page 222.

NOTE: AVX reserves the right to supply a higher voltage ratings or tighter tolerance part in the same case size, to the same reliability standards.

QUALIFICATION TABLE

TEST	TPS series (Temperature range -55°C to +125°C)										
	Condition			Characteristics							
Endurance	Apply rated voltage (UR) at 85±2°C and / or category voltage (Uc) at 125±2°C for 2000 +48/-0 hours through a circuit impedance of ≤0.1Ω/V. Stabilize at room temperature for 1-2 hours before measuring.			Visual examination	no visible damage						
				DCL	1.5 x initial limit						
				ΔC/C	within ±10% of initial value						
				DF	initial limit						
				ESR	1.25 x initial limit						
Humidity	Store at 65±2°C and 95±2% relative humidity for 500 +48/-0 hours, with no applied voltage. Stabilize at room temperature and humidity for 1-2 hours before measuring.			Visual examination	no visible damage						
				DCL	1.5 x initial limit						
				ΔC/C	within ±10% of initial value						
				DF	1.2 x initial limit						
				ESR	1.25 x initial limit						
Temperature Stability	Step	Temperature°C	Duration(min)		+20°C	-55°C	+20°C	+85°C	+125°C	+20°C	
	1	+20±2	15	DCL	IL*	n/a	IL*	10 x IL*	12.5 x IL*	IL*	
	2	-55+0/-3	15		ΔC/C	n/a	+0/-10%	±5%	+10/-0%	+12/-0%	±5%
	3	+20±2	15	DF		IL*	1.5 x IL*	IL*	1.5 x IL*	2 x IL*	IL*
	4	+85+3/-0	15		ESR	1.25 x IL*	2.5 x IL*	1.25 x IL*	1.25 x IL*	1.25 x IL*	1.25 x IL*
	5	+125+3/-0	15								
	6	+20±2	15								
Surge Voltage	Apply 1.3x category voltage (Uc) at 125 +3/-0°C for 1,000 cycles of duration 6 mins. (30 secs. charge, 5 min. 30 sec. discharge) through a charge / discharge resistance of 1000±100Ω			Visual examination	no visible damage						
				DCL	initial limit						
				ΔC/C	within ±5% of initial value						
				DF	initial limit						
				ESR	1.25 x initial limit						

*Initial Limit

AVX SOLID ELECTROLYTIC CAPACITOR ROADMAP

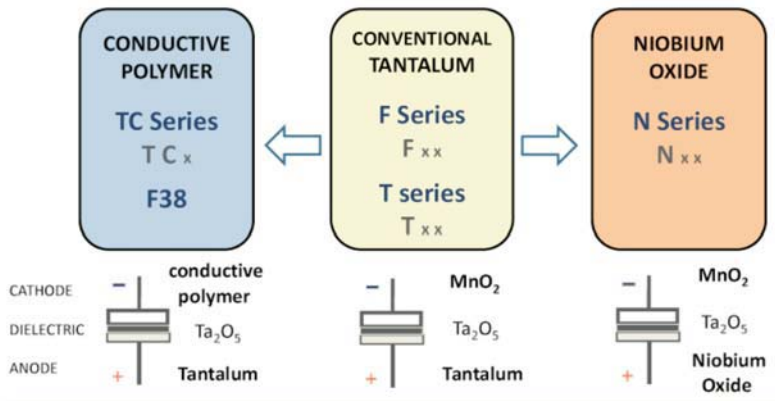

FIVE CAPACITOR CONSTRUCTION STYLES

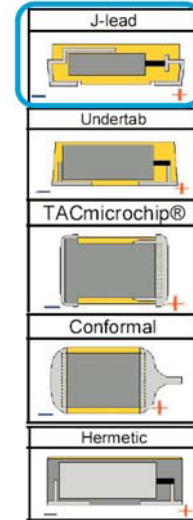

SERIES LINE UP: CONVENTIONAL SMD MnO₂

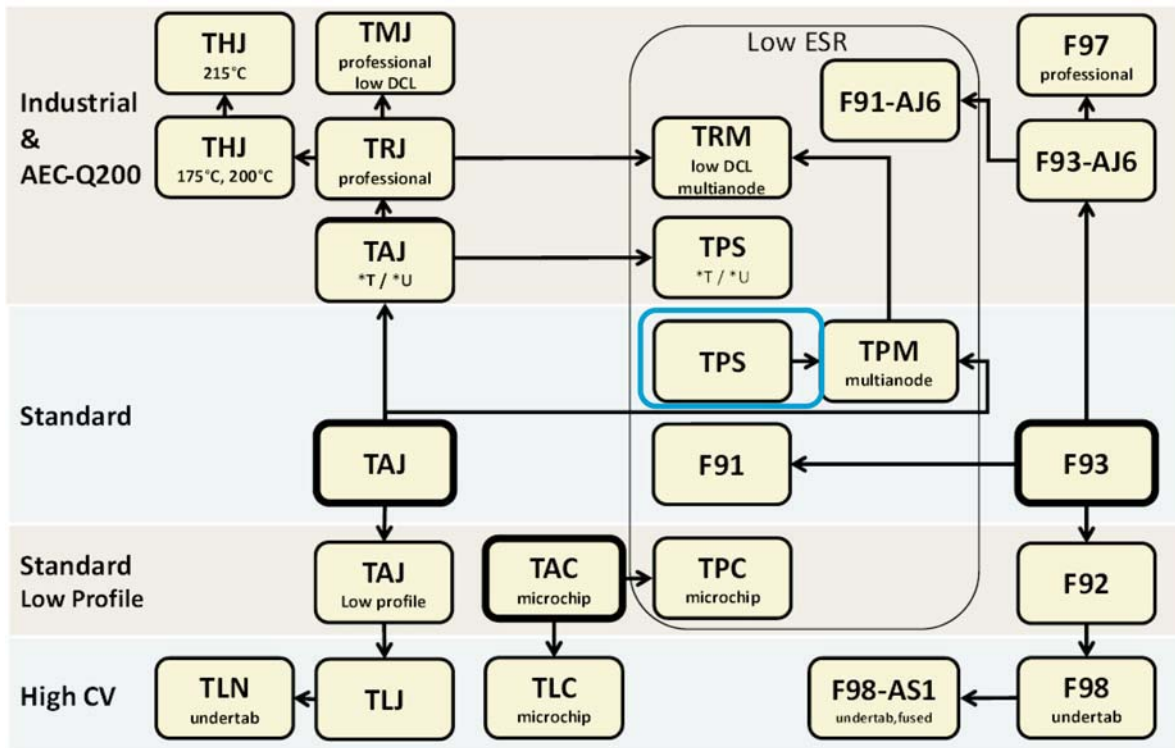

TPS Automotive Range



Low ESR - Automotive Product Range



FEATURES

- Low ESR series of robust MnO₂ solid electrolyte capacitors
- CV range: 0.22-680µF / 6.3-50V
- 5 case sizes available
- Power supply applications



APPLICATIONS

- Power Supply
- Electric Window Control
- Battery Management Systems
- DC/DC Converter

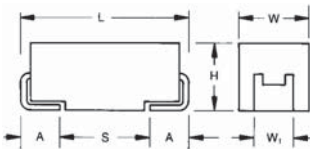

MARKING

A, B, C, D, E CASE

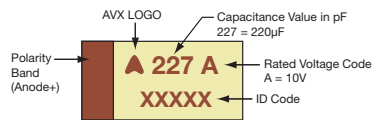

CASE DIMENSIONS: millimeters (inches)

Code	EIA Code	EIA Metric	L±0.20 (0.008)	W+0.20 (0.008) -0.10 (0.004)	H+0.20 (0.008) -0.10 (0.004)	W±0.20 (0.008)	A+0.30 (0.012) -0.20 (0.008)	S Min.
A	1206	3216-18	3.20 (0.126)	1.60 (0.063)	1.60 (0.063)	1.20 (0.047)	0.80 (0.031)	1.10 (0.043)
B	1210	3528-21	3.50 (0.138)	2.80 (0.110)	1.90 (0.075)	2.20 (0.087)	0.80 (0.031)	1.40 (0.055)
C	2312	6032-28	6.00 (0.236)	3.20 (0.126)	2.60 (0.102)	2.20 (0.087)	1.30 (0.051)	2.90 (0.114)
D	2917	7343-31	7.30 (0.287)	4.30 (0.169)	2.90 (0.114)	2.40 (0.094)	1.30 (0.051)	4.40 (0.173)
E	2917	7343-43	7.30 (0.287)	4.30 (0.169)	4.10 (0.162)	2.40 (0.094)	1.30 (0.051)	4.40 (0.173)

W1 dimension applies to the termination width for A dimensional area only.

HOW TO ORDER

TPS	C	107	M	010	T	0150	V
Type	Case Size See table above	Capacitance Code pF code: 1st two digits represent significant figures, 3rd digit represents multiplier (number of zeros to follow)	Tolerance K = ±10% M = ±20%	Rated DC Voltage 006 = 6.3Vdc 010 = 10Vdc 016 = 16Vdc 020 = 20Vdc	Packaging T = Automotive Lead Free 7" Reel U = Automotive Lead Free 13" Reel	ESR in mΩ	Dry Pack Option (D,E case sizes mandatory)

TECHNICAL SPECIFICATIONS

Technical Data:	All technical data relate to an ambient temperature of +25°C								
Capacitance Range:	0.22 µF to 680 µF								
Capacitance Tolerance:	±10%; ±20%								
Rated Voltage (V _R)	≤ +85°C:	6.3	10	16	20	25	35	50	
Category Voltage (V _C)	≤ +125°C:	4	7	10	13	17	23	33	
Surge Voltage (V _S)	≤ +85°C:	8	13	20	26	32	46	65	
Surge Voltage (V _S)	≤ +125°C:	5	8	13	16	20	28	40	
Temperature Range:	-55°C to +125°C								
Environmental Classification:	55/125/56 (IEC 68-2)								
Reliability:	1% per 1000 hours at 85°C, V _R with 0.1Ω/V series impedance, 60% confidence level								
Termination Finished:	Sn Plating (standard), Gold and SnPb Plating upon request								
	Meets requirements of AEC-Q200								

TPS Automotive Range



Low ESR - Automotive Product Range

TPS AUTOMOTIVE RANGE CAPACITANCE AND RATED VOLTAGE RANGE (LETTER DENOTES CASE SIZE)

Capacitance		Rated Voltage DC (V _r) to 85°C						
µF	Code	6.3V (J)	10V (A)	16V (C)	20V (D)	25V (E)	35V (V)	50V (T)
0.15	154							
0.22	224							A(7000)
0.33	334						A(6000)	A(7000)
0.47	474					A(7000)	A(6000)	A(6500), B(6000)
0.68	684					A(6000)	A(6000)	B(4000)
1.0	105			A(6200)	A(3000)	A(4000)	A(3000), B(2000)	B(3000), C(2500)
1.5	155				A(3000)	A(3000)	A(3000), B(2500)	C(1500,2000)
2.2	225		A(1800)	A(1800,3500)	A(3000), B(1700)	A(2500), B(900,1200,2500)	B(750,1500,2000), C(1000)	C(1500), D(1200)
3.3	335	A(2100)		A(3500), B(2500)	A(2500), B(1300)	B(750,1500,2000)	B(1000), C(700)	C(1000), D(800)
4.7	475		A(1400), B(1400)	A(2000), B(800,1500)	A(1800), B(750,1000)	B(700,900), C(700)	B(700,1500), C(600), D(700)	C(800), D(250,500,700)
6.8	685		A(1800), B(1300)	A(1500), B(600,1200)	B(600,1000), C(700)	B(700), C(500,600,700)	C(350), D(400,500)	D(500,600)
10	106	A(1500), B(1500)	A(900,1800), B(1000)	A(1000), B(500,800), C(500)	B(500,1000), C(500,700)	C(300,500), D(500)	C(600), D(300)	D(500), E(250,300,400,500)
15	156	A(700,1500)	A(1000), B(450,600), C(700)	B(600,800) C(300,700)	B(500), C(400,450)	C(220,300), D(300)	D(300)	E(250)
22	226	A(500,900), B(375,600), C(500)	A(900), B(400,500,700), C(180,300)	B(400,600), C(300,375), D(500), D(700)	C(400), D(200,300)	C(275,400), D(200,300)	D(200,300,400), E(200,300)	
33	336	A(600), B(250,350,450,600)	B(250,425,500,650), C(375,500)	C(225,300), D(200)	C(300), D(160,200)	D(200,300)	E(250,300)	
47	476	B(250,350,500), C(300)	B(250,350,500,650), C(200,350), D(300)	C(350), D(150,200)	D(200)	D(125,150,250), E(125)		
68	686	B(250,350,500), C(150,200)	C(200,300), D(150)	C(200), D(150)	D(150,200,300), E(125,150,200)			
100	107	C(150), D(300)	C(150,200), D(100,125,150)	D(100,125,150), E(100,125,150)	E(100,150,200)	E(150)		
150	157	C(150,200,250), D(125)	D(85,100), E(100)	E(100)				
220	227	D(100,125)	D(100,150), E(70,100,125,150)					
330	337	D(45,50,70,100), E(100,125,150)	E(50,60,100)					
470	477	D(45,60,100,200), E(45,50,60,100,200)						
680	687	E(45,60,100)						

Not recommended for new designs; higher voltage or smaller case size alternatives are available.

Released ratings (ESR ratings in mOhms in parenthesis)

Engineering samples - please contact AVX

Note: Voltage ratings are minimum values. AVX reserves the right to supply higher ratings in the same case size, to the same reliability standards.

TPS Automotive Range

Low ESR - Automotive Product Range



RATINGS & PART NUMBER REFERENCE

AVX Part No.	Case Size	Capacitance (µF)	Rated Voltage (V)	Rated Temperature (°C)	Category Voltage (V)	Category Temperature (°C)	DCL Max. (µA)	DF Max. (%)	ESR Max. @ 100kHz (mΩ)	MSL	100kHz RMS Current (A)		
											25°C	85°C	125°C
6.3 Volt @ 85°C													
TPSA335*006T2100	A	3.3	6.3	85	4	125	0.5	6	2100	1	0.189	0.170	0.076
TPSA106*006T1500	A	10	6.3	85	4	125	0.6	6	1500	1	0.224	0.201	0.089
TPSB106*006T1500	B	10	6.3	85	4	125	0.6	6	1500	1	0.238	0.214	0.095
TPSA156*006T0700	A	15	6.3	85	4	125	0.9	6	700	1	0.327	0.295	0.131
TPSA156*006T1500	A	15	6.3	85	4	125	0.9	6	1500	1	0.224	0.201	0.089
TPSA226*006T0500	A	22	6.3	85	4	125	1.4	6	500	1	0.387	0.349	0.155
TPSA226*006T0900	A	22	6.3	85	4	125	1.4	6	900	1	0.289	0.260	0.115
TPSB226*006T0375	B	22	6.3	85	4	125	1.4	6	375	1	0.476	0.428	0.190
TPSB226*006T0600	B	22	6.3	85	4	125	1.4	6	600	1	0.376	0.339	0.151
TPSC226*006T0500	C	22	6.3	85	4	125	1.4	6	500	1	0.469	0.422	0.188
TPSA336*006T0600	A	33	6.3	85	4	125	2.1	8	600	1	0.354	0.318	0.141
TPSB336*006T0250	B	33	6.3	85	4	125	2.1	6	250	1	0.583	0.525	0.233
TPSB336*006T0350	B	33	6.3	85	4	125	2.1	6	350	1	0.493	0.444	0.197
TPSB336*006T0450	B	33	6.3	85	4	125	2.1	6	450	1	0.435	0.391	0.174
TPSB336*006T0600	B	33	6.3	85	4	125	2.1	6	600	1	0.376	0.339	0.151
TPSB476*006T0250	B	47	6.3	85	4	125	3	6	250	1	0.583	0.525	0.233
TPSB476*006T0350	B	47	6.3	85	4	125	3	6	350	1	0.493	0.444	0.197
TPSB476*006T0500	B	47	6.3	85	4	125	3	6	500	1	0.412	0.371	0.165
TPSC476*006T0300	C	47	6.3	85	4	125	3	6	300	1	0.606	0.545	0.242
TPSB686*006T0250	B	68	6.3	85	4	125	4	8	250	1	0.583	0.525	0.233
TPSB686*006T0350	B	68	6.3	85	4	125	4	8	350	1	0.493	0.444	0.197
TPSB686*006T0500	B	68	6.3	85	4	125	4	8	500	1	0.412	0.371	0.165
TPSC686*006T0150	C	68	6.3	85	4	125	4.3	6	150	1	0.856	0.771	0.343
TPSC686*006T0200	C	68	6.3	85	4	125	4.3	6	200	1	0.742	0.667	0.297
TPSC107*006T0150	C	100	6.3	85	4	125	6.3	6	150	1	0.856	0.771	0.343
TPSD107*006T0300V	D	100	6.3	85	4	125	6.3	6	300	3	0.707	0.636	0.283
TPSC157*006T0150	C	150	6.3	85	4	125	9.5	6	150	1	0.856	0.771	0.343
TPSC157*006T0200	C	150	6.3	85	4	125	9.5	6	200	1	0.742	0.667	0.297
TPSC157*006T0250	C	150	6.3	85	4	125	9.5	6	250	1	0.663	0.597	0.265
TPSD157*006T0125V	D	150	6.3	85	4	125	9.5	6	125	3	1.095	0.986	0.438
TPSD227*006T0100V	D	220	6.3	85	4	125	13.9	8	100	3	1.225	1.102	0.490
TPSD227*006T0125V	D	220	6.3	85	4	125	13.9	8	125	3	1.095	0.986	0.438
TPSD337*006T0045V	D	330	6.3	85	4	125	20.8	8	45	3	1.826	1.643	0.730
TPSD337*006T0050V	D	330	6.3	85	4	125	20.8	8	50	3	1.732	1.559	0.693
TPSD337*006T0070V	D	330	6.3	85	4	125	20.8	8	70	3	1.464	1.317	0.586
TPSD337*006T0100V	D	330	6.3	85	4	125	20.8	8	100	3	1.225	1.102	0.490
TPSE337*006T0100V	E	330	6.3	85	4	125	20.8	8	100	3	1.285	1.156	0.514
TPSE337*006T0125V	E	330	6.3	85	4	125	20.8	8	125	3	1.149	1.034	0.460
TPSE337*006T0150V	E	330	6.3	85	4	125	20.8	8	150	3	1.049	0.944	0.420
TPSD477*006T0045V	D	470	6.3	85	4	125	28	12	45	3	1.826	1.643	0.730
TPSD477*006T0060V	D	470	6.3	85	4	125	28	12	60	3	1.581	1.423	0.632
TPSD477*006T0100V	D	470	6.3	85	4	125	28	12	100	3	1.225	1.102	0.490
TPSD477*006T0200V	D	470	6.3	85	4	125	28	12	200	3	0.866	0.779	0.346
TPSE477*006T0045V	E	470	6.3	85	4	125	28	10	45	3	1.915	1.723	0.766
TPSE477*006T0050V	E	470	6.3	85	4	125	28	10	50	3	1.817	1.635	0.727
TPSE477*006T0060V	E	470	6.3	85	4	125	28	10	60	3	1.658	1.492	0.663
TPSE477*006T0100V	E	470	6.3	85	4	125	28	10	100	3	1.285	1.156	0.514
TPSE477*006T0200V	E	470	6.3	85	4	125	28	10	200	3	0.908	0.817	0.363
TPSE687*006T0045V	E	680	6.3	85	4	125	42.8	10	45	3	1.915	1.723	0.766
TPSE687*006T0060V	E	680	6.3	85	4	125	42.8	10	60	3	1.658	1.492	0.663
TPSE687*006T0100V	E	680	6.3	85	4	125	42.8	10	100	3	1.285	1.156	0.514
10 Volt @ 85°C													
TPSA225*010T1800	A	2.2	10	85	7	125	0.5	6	1800	1	0.204	0.184	0.082
TPSA475*010T1400	A	4.7	10	85	7	125	0.5	6	1400	1	0.231	0.208	0.093
TPSB475*010T1400	B	4.7	10	85	7	125	0.5	6	1400	1	0.246	0.222	0.099
TPSA685*010T1800	A	6.8	10	85	7	125	0.7	6	1800	1	0.204	0.184	0.082
TPSB685*010T1300	B	6.8	10	85	7	125	0.7	6	1300	1	0.256	0.230	0.102
TPSA106*010T0900	A	10	10	85	7	125	1	6	900	1	0.289	0.260	0.115
TPSA106*010T1800	A	10	10	85	7	125	1	6	1800	1	0.204	0.184	0.082
TPSB106*010T1000	B	10	10	85	7	125	1	6	1000	1	0.292	0.262	0.117
TPSA156*010T1000	A	15	10	85	7	125	1.5	6	1000	1	0.274	0.246	0.110
TPSB156*010T0450	B	15	10	85	7	125	1.5	6	450	1	0.435	0.391	0.174
TPSB156*010T0600	B	15	10	85	7	125	1.5	6	600	1	0.376	0.339	0.151
TPSC156*010T0700	C	15	10	85	7	125	1.5	6	700	1	0.396	0.357	0.159
TPSA226*010T0900	A	22	10	85	7	125	2.2	8	900	1	0.289	0.260	0.115
TPSB226*010T0400	B	22	10	85	7	125	2.2	6	400	1	0.461	0.415	0.184
TPSB226*010T0500	B	22	10	85	7	125	2.2	6	500	1	0.412	0.371	0.165
TPSB226*010T0700	B	22	10	85	7	125	2.2	6	700	1	0.348	0.314	0.139
TPSC226*010T0180	C	22	10	85	7	125	2.2	6	180	1	0.782	0.704	0.313
TPSC226*010T0300	C	22	10	85	7	125	2.2	6	300	1	0.606	0.545	0.242
TPSB336*010T0250	B	33	10	85	7	125	3.3	6	250	1	0.583	0.525	0.233

TPS Automotive Range



Low ESR - Automotive Product Range

RATINGS & PART NUMBER REFERENCE

AVX Part No.	Case Size	Capacitance (µF)	Rated Voltage (V)	Rated Temperature (°C)	Category Voltage (V)	Category Temperature (°C)	DCL Max. (µA)	DF Max. (%)	ESR Max. @ 100kHz (mΩ)	MSL	100kHz RMS Current (A)		
											25°C	85°C	125°C
TPSB336*010T0425	B	33	10	85	7	125	3.3	6	425	1	0.447	0.402	0.179
TPSB336*010T0500	B	33	10	85	7	125	3.3	6	500	1	0.412	0.371	0.165
TPSB336*010T0650	B	33	10	85	7	125	3.3	6	650	1	0.362	0.325	0.145
TPSC336*010T0375	C	33	10	85	7	125	3.3	6	375	1	0.542	0.487	0.217
TPSC336*010T0500	C	33	10	85	7	125	3.3	6	500	1	0.469	0.422	0.188
TPSB476*010T0250	B	47	10	85	7	125	4.7	8	250	1	0.583	0.525	0.233
TPSB476*010T0350	B	47	10	85	7	125	4.7	8	350	1	0.493	0.444	0.197
TPSB476*010T0500	B	47	10	85	7	125	4.7	8	500	1	0.412	0.371	0.165
TPSB476*010T0650	B	47	10	85	7	125	4.7	8	650	1	0.362	0.325	0.145
TPSC476*010T0200	C	47	10	85	7	125	4.7	6	200	1	0.742	0.667	0.297
TPSC476*010T0350	C	47	10	85	7	125	4.7	6	350	1	0.561	0.505	0.224
TPSD476*010T0300V	D	47	10	85	7	125	4.7	6	300	3	0.707	0.636	0.283
TPSC686*010T0200	C	68	10	85	7	125	6.8	6	200	1	0.742	0.667	0.297
TPSC686*010T0300	C	68	10	85	7	125	6.8	6	300	1	0.606	0.545	0.242
TPSD686*010T0150V	D	68	10	85	7	125	6.8	6	150	3	1.000	0.900	0.400
TPSC107*010T0150	C	100	10	85	7	125	10	8	150	1	0.856	0.771	0.343
TPSC107*010T0200	C	100	10	85	7	125	10	8	200	1	0.742	0.667	0.297
TPSD107*010T0100V	D	100	10	85	7	125	10	6	100	3	1.225	1.102	0.490
TPSD107*010T0125V	D	100	10	85	7	125	10	6	125	3	1.095	0.986	0.438
TPSD107*010T0150V	D	100	10	85	7	125	10	6	150	3	1.000	0.900	0.400
TPSD157*010T0085V	D	150	10	85	7	125	15	8	85	3	1.328	1.196	0.531
TPSD157*010T0100V	D	150	10	85	7	125	15	8	100	3	1.225	1.102	0.490
TPSE157*010T0100V	E	150	10	85	7	125	15	8	100	3	1.285	1.156	0.514
TPSD227*010T0100V	D	220	10	85	7	125	22	8	100	3	1.225	1.102	0.490
TPSD227*010T0150V	D	220	10	85	7	125	22	8	150	3	1.000	0.900	0.400
TPSE227*010T0070V	E	220	10	85	7	125	22	8	70	3	1.535	1.382	0.614
TPSE227*010T0100V	E	220	10	85	7	125	22	8	100	3	1.285	1.156	0.514
TPSE227*010T0125V	E	220	10	85	7	125	22	8	125	3	1.149	1.034	0.460
TPSE227*010T0150V	E	220	10	85	7	125	22	8	150	3	1.049	0.944	0.420
TPSE337*010T0050V	E	330	10	85	7	125	33	8	50	3	1.817	1.635	0.727
TPSE337*010T0060V	E	330	10	85	7	125	33	8	60	3	1.658	1.492	0.663
TPSE337*010T0100V	E	330	10	85	7	125	33	8	100	3	1.285	1.156	0.514
16 Volt @ 85°C													
TPSA105*016T6200	A	1.0	16	85	10	125	0.5	4	6200	1	0.110	0.099	0.044
TPSA225*016T1800	A	2.2	16	85	10	125	0.5	6	1800	1	0.204	0.184	0.082
TPSA225*016T3500	A	2.2	16	85	10	125	0.5	6	3500	1	0.146	0.132	0.059
TPSA335*016T3500	A	3.3	16	85	10	125	0.5	6	3500	1	0.146	0.132	0.059
TPSB335*016T2500	B	3.3	16	85	10	125	0.5	6	2500	1	0.184	0.166	0.074
TPSA475*016T2000	A	4.7	16	85	10	125	0.8	6	2000	1	0.194	0.174	0.077
TPSB475*016T0800	B	4.7	16	85	10	125	0.8	6	800	1	0.326	0.293	0.130
TPSB475*016T1500	B	4.7	16	85	10	125	0.8	6	1500	1	0.238	0.214	0.095
TPSA685*016T1500	A	6.8	16	85	10	125	1.1	6	1500	1	0.224	0.201	0.089
TPSB685*016T0600	B	6.8	16	85	10	125	1.1	6	600	1	0.376	0.339	0.151
TPSB685*016T1200	B	6.8	16	85	10	125	1.1	6	1200	1	0.266	0.240	0.106
TPSA106*016T1000	A	10	16	85	10	125	1.6	6	1000	1	0.274	0.246	0.110
TPSB106*016T0500	B	10	16	85	10	125	1.6	6	500	1	0.412	0.371	0.165
TPSB106*016T0800	B	10	16	85	10	125	1.6	6	800	1	0.326	0.293	0.130
TPSC106*016T0500	C	10	16	85	10	125	1.6	6	500	1	0.469	0.422	0.188
TPSB156*016T0500	B	15	16	85	10	125	2.4	6	500	1	0.412	0.371	0.165
TPSB156*016T0800	B	15	16	85	10	125	2.4	6	800	1	0.326	0.293	0.130
TPSC156*016T0300	C	15	16	85	10	125	2.4	6	300	1	0.606	0.545	0.242
TPSC156*016T0700	C	15	16	85	10	125	2.4	6	700	1	0.396	0.357	0.159
TPSB226*016T0400	B	22	16	85	10	125	3.5	6	400	1	0.461	0.415	0.184
TPSB226*016T0600	B	22	16	85	10	125	3.5	6	600	1	0.376	0.339	0.151
TPSC226*016T0300	C	22	16	85	10	125	3.5	6	300	1	0.606	0.545	0.242
TPSC226*016T0375	C	22	16	85	10	125	3.5	6	375	1	0.542	0.487	0.217
TPSD226*016T0500V	D	22	16	85	10	125	3.5	6	500	3	0.548	0.493	0.219
TPSD226*016T0700V	D	22	16	85	10	125	3.5	6	700	3	0.463	0.417	0.185
TPSC336*016T0225	C	33	16	85	10	125	5.3	6	225	1	0.699	0.629	0.280
TPSC336*016T0300	C	33	16	85	10	125	5.3	6	300	1	0.606	0.545	0.242
TPSD336*016T0200V	D	33	16	85	10	125	5.3	6	200	3	0.866	0.779	0.346
TPSC476*016T0350	C	47	16	85	10	125	7.5	6	350	1	0.561	0.505	0.224
TPSD476*016T0150V	D	47	16	85	10	125	7.5	6	150	3	1.000	0.900	0.400
TPSD476*016T0200V	D	47	16	85	10	125	7.5	6	200	3	0.866	0.779	0.346
TPSC686*016T0200	C	68	16	85	10	125	10.9	6	200	1	0.742	0.667	0.297
TPSD686*016T0150V	D	68	16	85	10	125	10.9	6	150	3	1.000	0.900	0.400
TPSD107*016T0100V	D	100	16	85	10	125	16	6	100	3	1.225	1.102	0.490
TPSD107*016T0125V	D	100	16	85	10	125	16	6	125	3	1.095	0.986	0.438
TPSD107*016T0150V	D	100	16	85	10	125	16	6	150	3	1.000	0.900	0.400
TPSE107*016T0100V	E	100	16	85	10	125	16	6	100	3	1.285	1.156	0.514
TPSE107*016T0125V	E	100	16	85	10	125	16	6	125	3	1.149	1.034	0.460
TPSE107*016T0150V	E	100	16	85	10	125	16	6	150	3	1.049	0.944	0.420
TPSE157*016T0100V	E	150	16	85	10	125	23	8	100	3	1.285	1.156	0.514

TPS Automotive Range



Low ESR - Automotive Product Range

RATINGS & PART NUMBER REFERENCE

AVX Part No.	Case Size	Capacitance (µF)	Rated Voltage (V)	Rated Temperature (°C)	Category Voltage (V)	Category Temperature (°C)	DCL Max. (µA)	DF Max. (%)	ESR Max. @ 100kHz (mΩ)	MSL	100kHz RMS Current (A)		
											25°C	85°C	125°C
20 Volt @ 85°C													
TPSA105*020T3000	A	1	20	85	13	125	0.5	4	3000	1	0.158	0.142	0.063
TPSA155*020T3000	A	1.5	20	85	13	125	0.5	6	3000	1	0.158	0.142	0.063
TPSA225*020T3000	A	2.2	20	85	13	125	0.5	6	3000	1	0.158	0.142	0.063
TPSB225*020T1700	B	2.2	20	85	13	125	0.5	6	1700	1	0.224	0.201	0.089
TPSA335*020T2500	A	3.3	20	85	13	125	0.7	6	2500	1	0.173	0.156	0.069
TPSB335*020T1300	B	3.3	20	85	13	125	0.7	6	1300	1	0.256	0.230	0.102
TPSA475*020T1800	A	4.7	20	85	13	125	0.9	6	1800	1	0.204	0.184	0.082
TPSB475*020T0750	B	4.7	20	85	13	125	0.9	6	750	1	0.337	0.303	0.135
TPSB475*020T1000	B	4.7	20	85	13	125	0.9	6	1000	1	0.292	0.262	0.117
TPSB685*020T0600	B	6.8	20	85	13	125	1.4	6	600	1	0.376	0.339	0.151
TPSB685*020T1000	B	6.8	20	85	13	125	1.4	6	1000	1	0.292	0.262	0.117
TPSC685*020T0700	C	6.8	20	85	13	125	1.4	6	700	1	0.396	0.357	0.159
TPSB106*020T0500	B	10	20	85	13	125	2	6	500	1	0.412	0.371	0.165
TPSB106*020T1000	B	10	20	85	13	125	2	6	1000	1	0.292	0.262	0.117
TPSC106*020T0500	C	10	20	85	13	125	2	6	500	1	0.469	0.422	0.188
TPSC106*020T0700	C	10	20	85	13	125	2	6	700	1	0.396	0.357	0.159
TPSB156*020T0500	B	15	20	85	13	125	3	6	500	1	0.412	0.371	0.165
TPSC156*020T0400	C	15	20	85	13	125	3	6	400	1	0.524	0.472	0.210
TPSC156*020T0450	C	15	20	85	13	125	3	6	450	1	0.494	0.445	0.198
TPSC226*020T0400	C	22	20	85	13	125	4.4	6	400	1	0.524	0.472	0.210
TPSD226*020T0200V	D	22	20	85	13	125	4.4	6	200	3	0.866	0.779	0.346
TPSD226*020T0300V	D	22	20	85	13	125	4.4	6	300	3	0.707	0.636	0.283
TPSC336*020T0300	C	33	20	85	13	125	6.6	6	300	1	0.606	0.545	0.242
TPSD336*020T0160V	D	33	20	85	13	125	6.6	6	160	3	0.968	0.871	0.387
TPSD336*020T0200V	D	33	20	85	13	125	6.6	6	200	3	0.866	0.779	0.346
TPSD476*020T0200V	D	47	20	85	13	125	9.4	6	200	3	0.866	0.779	0.346
TPSD686*020T0150V	D	68	20	85	13	125	13.6	6	150	3	1.000	0.900	0.400
TPSD686*020T0200V	D	68	20	85	13	125	13.6	6	200	3	0.866	0.779	0.346
TPSD686*020T0300V	D	68	20	85	13	125	13.6	6	300	3	0.707	0.636	0.283
TPSE686*020T0125V	E	68	20	85	13	125	13.6	6	125	3	1.149	1.034	0.460
TPSE686*020T0150V	E	68	20	85	13	125	13.6	6	150	3	1.049	0.944	0.420
TPSE686*020T0200V	E	68	20	85	13	125	13.6	6	200	3	0.908	0.817	0.363
TPSE107*020T0100V	E	100	20	85	13	125	20	6	100	3	1.285	1.156	0.514
TPSE107*020T0150V	E	100	20	85	13	125	20	6	150	3	1.049	0.944	0.420
TPSE107*020T0200V	E	100	20	85	13	125	20	6	200	3	0.908	0.817	0.363
25 Volt @ 85°C													
TPSA474*025T7000	A	0.47	25	85	17	125	0.5	4	7000	1	0.104	0.093	0.041
TPSA684*025T6000	A	0.68	25	85	17	125	0.5	4	6000	1	0.112	0.101	0.045
TPSA105*025T4000	A	1.0	25	85	17	125	0.5	4	4000	1	0.137	0.123	0.055
TPSA155*025T3000	A	1.5	25	85	17	125	0.5	6	3000	1	0.158	0.142	0.063
TPSA225*025T2500	A	2.2	25	85	17	125	0.6	6	2500	1	0.173	0.156	0.069
TPSB225*025T0900	B	2.2	25	85	17	125	0.6	6	900	1	0.307	0.277	0.123
TPSB225*025T1200	B	2.2	25	85	17	125	0.6	6	1200	1	0.266	0.240	0.106
TPSB225*025T2500	B	2.2	25	85	17	125	0.6	6	2500	1	0.184	0.166	0.074
TPSB335*025T0750	B	3.3	25	85	17	125	0.8	6	750	1	0.337	0.303	0.135
TPSB335*025T1500	B	3.3	25	85	17	125	0.8	6	1500	1	0.238	0.214	0.095
TPSB335*025T2000	B	3.3	25	85	17	125	0.8	6	2000	1	0.206	0.186	0.082
TPSB475*025T0700	B	4.7	25	85	17	125	1.2	6	700	1	0.348	0.314	0.139
TPSB475*025T0900	B	4.7	25	85	17	125	1.2	6	900	1	0.307	0.277	0.123
TPSC475*025T0700	C	4.7	25	85	17	125	1.2	6	700	1	0.396	0.357	0.159
TPSB685*025T0700	B	6.8	25	85	17	125	1.7	6	700	1	0.348	0.314	0.139
TPSC685*025T0500	C	6.8	25	85	17	125	1.7	6	500	1	0.469	0.422	0.188
TPSC685*025T0600	C	6.8	25	85	17	125	1.7	6	600	1	0.428	0.385	0.171
TPSC685*025T0700	C	6.8	25	85	17	125	1.7	6	700	1	0.396	0.357	0.159
TPSC106*025T0300	C	10	25	85	17	125	2.5	6	300	1	0.606	0.545	0.242
TPSC106*025T0500	C	10	25	85	17	125	2.5	6	500	1	0.469	0.422	0.188
TPSD106*025T0500V	D	10	25	85	17	125	2.5	6	500	3	0.548	0.493	0.219
TPSC156*025T0220	C	15	25	85	17	125	3.8	6	220	1	0.707	0.636	0.283
TPSC156*025T0300	C	15	25	85	17	125	3.8	6	300	1	0.606	0.545	0.242
TPSD156*025T0300V	D	15	25	85	17	125	3.8	6	300	3	0.707	0.636	0.283
TPSC226*025T0275	C	22	25	85	17	125	5.5	6	275	1	0.632	0.569	0.253
TPSC226*025T0400	C	22	25	85	17	125	5.5	6	400	1	0.524	0.472	0.210
TPSD226*025T0200V	D	22	25	85	17	125	5.5	6	200	3	0.866	0.779	0.346
TPSD226*025T0300V	D	22	25	85	17	125	5.5	6	300	3	0.707	0.636	0.283
TPSD336*025T0200V	D	33	25	85	17	125	8.3	6	200	3	0.866	0.779	0.346
TPSD336*025T0300V	D	33	25	85	17	125	8.3	6	300	3	0.707	0.636	0.283
TPSD476*025T0125V	D	47	25	85	17	125	11.8	6	125	3	1.095	0.986	0.438
TPSD476*025T0150V	D	47	25	85	17	125	11.8	6	150	3	1.000	0.900	0.400
TPSD476*025T0250V	D	47	25	85	17	125	11.8	6	250	3	0.775	0.697	0.310
TPSE476*025T0125V	E	47	25	85	17	125	11.8	6	125	3	1.149	1.034	0.460
TPSE107*025T0150V	E	100	25	85	17	125	25	10	150	3	1.049	0.944	0.420



TPS Automotive Range

Low ESR - Automotive Product Range



RATINGS & PART NUMBER REFERENCE

AVX Part No.	Case Size	Capacitance (µF)	Rated Voltage (V)	Rated Temperature (°C)	Category Voltage (V)	Category Temperature (°C)	DCL Max. (µA)	DF Max. (%)	ESR Max. @ 100kHz (mΩ)	MSL	100kHz RMS Current (A)		
											25°C	85°C	125°C
35 Volt @ 85°C													
TPSA334*035T6000	A	0.33	35	85	23	125	0.5	4	6000	1	0.112	0.101	0.045
TPSA474*035T6000	A	0.47	35	85	23	125	0.5	4	6000	1	0.112	0.101	0.045
TPSA684*035T6000	A	0.68	35	85	23	125	0.5	4	6000	1	0.112	0.101	0.045
TPSA105*035T3000	A	1	35	85	23	125	0.5	4	3000	1	0.158	0.142	0.063
TPSB105*035T2000	B	1	35	85	23	125	0.5	4	2000	1	0.206	0.186	0.082
TPSA155*035T3000	A	1.5	35	85	23	125	0.5	6	3000	1	0.158	0.142	0.063
TPSB155*035T2500	B	1.5	35	85	23	125	0.5	6	2500	1	0.184	0.166	0.074
TPSB225*035T0750	B	2.2	35	85	23	125	0.8	6	750	1	0.337	0.303	0.135
TPSB225*035T1500	B	2.2	35	85	23	125	0.8	6	1500	1	0.238	0.214	0.095
TPSB225*035T2000	B	2.2	35	85	23	125	0.8	6	2000	1	0.206	0.186	0.082
TPSC225*035T1000	C	2.2	35	85	23	125	0.8	6	1000	1	0.332	0.298	0.133
TPSB335*035T1000	B	3.3	35	85	23	125	1.2	6	1000	1	0.292	0.262	0.117
TPSC335*035T0700	C	3.3	35	85	23	125	1.2	6	700	1	0.396	0.357	0.159
TPSB475*035T0700	B	4.7	35	85	23	125	1.6	6	700	1	0.348	0.314	0.139
TPSB475*035T1500	B	4.7	35	85	23	125	1.6	6	1500	1	0.238	0.214	0.095
TPSC475*035T0600	C	4.7	35	85	23	125	1.6	6	600	1	0.428	0.385	0.171
TPSD475*035T0700V	D	4.7	35	85	23	125	1.6	6	700	3	0.463	0.417	0.185
TPSC685*035T0350	C	6.8	35	85	23	125	2.4	6	350	1	0.561	0.505	0.224
TPSD685*035T0400V	D	6.8	35	85	23	125	2.4	6	400	3	0.612	0.551	0.245
TPSD685*035T0500V	D	6.8	35	85	23	125	2.4	6	500	3	0.548	0.493	0.219
TPSC106*035T0600	C	10	35	85	23	125	3.5	6	600	1	0.428	0.385	0.171
TPSD106*035T0300V	D	10	35	85	23	125	3.5	6	300	3	0.707	0.636	0.283
TPSD156*035T0300V	D	15	35	85	23	125	5.3	6	300	3	0.707	0.636	0.283
TPSD226*035T0200V	D	22	35	85	23	125	7.7	6	200	3	0.866	0.779	0.346
TPSD226*035T0300V	D	22	35	85	23	125	7.7	6	300	3	0.707	0.636	0.283
TPSD226*035T0400V	D	22	35	85	23	125	7.7	6	400	3	0.612	0.551	0.245
TPSE226*035T0200V	E	22	35	85	23	125	7.7	6	200	3	0.908	0.817	0.363
TPSE226*035T0300V	E	22	35	85	23	125	7.7	6	300	3	0.742	0.667	0.297
TPSE336*035T0250V	E	33	35	85	23	125	11.6	6	250	3	0.812	0.731	0.325
TPSE336*035T0300V	E	33	35	85	23	125	11.6	6	300	3	0.742	0.667	0.297
50 Volt @ 85°C													
TPSA224*050T7000	A	0.22	50	85	33	125	0.5	4	7000	1	0.104	0.093	0.041
TPSA334*050T7000	A	0.33	50	85	33	125	0.5	4	7000	1	0.104	0.093	0.041
TPSA474*050T6500	A	0.47	50	85	33	125	0.5	4	6500	1	0.107	0.097	0.043
TPSB474*050T6000	B	0.47	50	85	33	125	0.5	4	6000	1	0.119	0.107	0.048
TPSB684*050T4000	B	0.68	50	85	33	125	0.5	4	4000	1	0.146	0.131	0.058
TPSB105*050T3000	B	1	50	85	33	125	0.5	6	3000	1	0.168	0.151	0.067
TPSC105*050T2500	C	1	50	85	33	125	0.5	4	2500	1	0.210	0.189	0.084
TPSC155*050T1500	C	1.5	50	85	33	125	0.8	6	1500	1	0.271	0.244	0.108
TPSC155*050T2000	C	1.5	50	85	33	125	0.8	6	2000	1	0.235	0.211	0.094
TPSC225*050T1500	C	2.2	50	85	33	125	1.1	8	1500	1	0.271	0.244	0.108
TPSD225*050T1200V	D	2.2	50	85	33	125	1.1	6	1200	3	0.354	0.318	0.141
TPSC335*050T1000	C	3.3	50	85	33	125	1.6	6	1000	1	0.332	0.298	0.133
TPSD335*050T0800V	D	3.3	50	85	33	125	1.7	6	800	3	0.433	0.390	0.173
TPSC475*050T0800	C	4.7	50	85	33	125	2.4	6	800	1	0.371	0.334	0.148
TPSD475*050T0250V	D	4.7	50	85	33	125	2.4	6	250	1	0.775	0.697	0.310
TPSD475*050T0500V	D	4.7	50	85	33	125	2.4	6	500	3	0.548	0.493	0.219
TPSD475*050T0700V	D	4.7	50	85	33	125	2.4	6	700	3	0.463	0.417	0.185
TPSD685*050T0500V	D	6.8	50	85	33	125	3.4	6	500	3	0.548	0.493	0.219
TPSD685*050T0600V	D	6.8	50	85	33	125	3.4	6	600	3	0.500	0.450	0.200
TPSD106*050T0500V	D	10	50	85	33	125	5	6	500	3	0.548	0.493	0.219
TPSE106*050T0250V	E	10	50	85	33	125	5	6	250	3	0.812	0.731	0.325
TPSE106*050T0300V	E	10	50	85	33	125	5	6	300	3	0.742	0.667	0.297
TPSE106*050T0400V	E	10	50	85	33	125	5	6	400	3	0.642	0.578	0.257
TPSE106*050T0500V	E	10	50	85	33	125	5	6	500	3	0.574	0.517	0.230
TPSE156*050T0250V	E	15	50	85	33	125	7.5	6	250	3	0.812	0.731	0.325

Moisture Sensitivity Level (MSL) is defined according to J-STD-020

*Please use "U" instead of "T" in the suffix letter for 13" reel packaging

Please use specific PN for automotive version – see "HOW TO ORDER".

All technical data relates to an ambient temperature of +25°C. Capacitance and DF are measured at 120Hz, 0.5V RMS with a maximum DC bias of 2.2 volts.

DCL is measured at rated voltage after 5 minutes.

The EIA & CECC standards for low ESR Solid Tantalum Capacitors allow an ESR movement to 1.25 times catalogue limit post mounting.

For typical weight and composition see page 222.

NOTE: AVX reserves the right to supply a higher voltage rating or tighter tolerance part in the same case size, to the same reliability standards.

TPS Automotive Range



Low ESR - Automotive Product Range

QUALIFICATION TABLE

TEST	TPS automotive series (Temperature range -55°C to +125°C)										
	Condition			Characteristics							
Endurance	Determine after application of rated voltage for 2000 +48/-0 hours at 85±2°C and then leaving 1-2 hours at room temperature. Also determine of 125°C temperature, category voltage for 2000 +48/-0 hours and then leaving 1-2 hours at room temperature. Power supply impedance to be ≤0.1Ω/V.			Visual examination	no visible damage						
				DCL	1.25 x initial limit						
				ΔC/C	within ±10% of initial value						
				DF	initial limit						
				ESR	1.25 x initial limit						
Storage Life	125°C, 0V, 2000h			Visual examination	no visible damage						
				DCL	1.25 x initial limit						
				ΔC/C	within ±10% of initial value						
				DF	initial limit						
				ESR	1.25 x initial limit						
Humidity	Determine after storage without applied voltage at 65±2°C and 95±2% relative humidity for 500 hours and then recovery 1-2 hours at room temperature.			Visual examination	no visible damage						
				DCL	1.5 x initial limit						
				ΔC/C	within ±10% of initial value						
				DF	1.2 x initial limit						
				ESR	1.25 x initial limit						
Biased Humidity	Determine after leaving for 1000 hours at 85±2°C, 85% relative humidity and rated voltage and then recovery 1-2 hours at room temperature.			Visual examination	no visible damage						
				DCL	2 x initial limit						
				ΔC/C	within ±10% of initial value						
				DF	1.2 x initial limit						
				ESR	1.25 x initial limit						
Temperature Stability	Step	Temperature°C	Duration(min)		+20°C	-55°C	+20°C	+85°C	+125°C	+20°C	
	1	+20±2	15	DCL	IL*	n/a	IL*	10 x IL*	12.5 x IL*	IL*	
	2	-55+0/-3	15	ΔC/C	n/a	+0/-10%	±5%	+10/-0%	+12/-0%	±5%	
	3	+20±2	15	DF	IL*	1.5 x IL*	IL*	1.5 x IL*	2 x IL*	IL*	
	4	+85+3/-0	15	ESR	1.25 x IL*	2.5 x IL*	1.25 x IL*	1.25 x IL*	1.25 x IL*	1.25 x IL*	
	5	+125+3/-0	15								
	6	+20±2	15								
Surge Voltage	Test temperature: 125°C+3/0°C Test voltage: Category voltage at 125°C Surge voltage: 1.3 x category voltage at 125°C Series protection resistance 1000±100Ω Discharge resistance: 1000Ω Number of cycles: 1000x Cycle duration: 6 min; 30 sec charge, 5 min 30 sec discharge			Visual examination	no visible damage						
				DCL	initial limit						
				ΔC/C	within ±5% of initial value						
				DF	initial limit						
				ESR	1.25 x initial limit						
Mechanical Shock	MIL-STD-202, Method 213, Condition F			Visual examination	no visible damage						
				DCL	initial limit						
				ΔC/C	within ±5% of initial value						
				DF	initial limit						
				ESR	1.25 x initial limit						
Vibration	MIL-STD-202, Method 204, Condition D			Visual examination	no visible damage						
				DCL	initial limit						
				ΔC/C	within ±5% of initial value						
				DF	initial limit						
				ESR	1.25 x initial limit						

*Initial Limit

F91 Series



Low ESR, Resin-Molded Chip J-Lead



FEATURES

- Compliant to the RoHS2 directive 2011/65/EU
- SMD J-lead
- Low ESR



APPLICATIONS

- General medium power DC/DC convertors

CASE DIMENSIONS: millimeters (inches)

Code	EIA Code	EIA Metric	L	W ₁	W ₂	H	S
B	1210	3528-21	3.50 ± 0.20 (0.126 ± 0.008)	2.80 ± 0.20 (0.110 ± 0.008)	2.20 ± 0.10 (0.087 ± 0.004)	1.90 ± 0.20 (0.075 ± 0.008)	0.80 ± 0.20 (0.031 ± 0.008)
C	2312	6032-27	6.00 ± 0.20 (0.236 ± 0.008)	3.20 ± 0.20 (0.126 ± 0.008)	2.20 ± 0.10 (0.087 ± 0.004)	2.50 ± 0.20 (0.098 ± 0.008)	1.30 ± 0.20 (0.051 ± 0.008)
N	2917	7343-30	7.30 ± 0.20 (0.287 ± 0.008)	4.30 ± 0.20 (0.169 ± 0.008)	2.40 ± 0.10 (0.094 ± 0.004)	2.80 ± 0.20 (0.110 ± 0.008)	1.30 ± 0.20 (0.051 ± 0.008)

B CASE

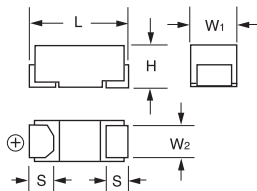

C, N CASE

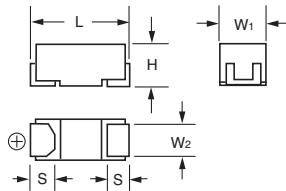

MARKING

B CASE

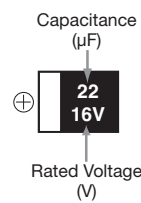

C CASE

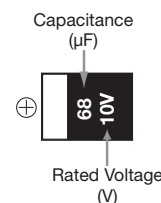

N CASE

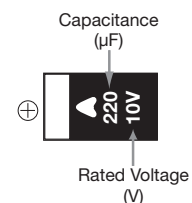

HOW TO ORDER

F91

Type

1A

Rated Voltage

107

Capacitance Code

pF code: 1st two digits represent significant figures, 3rd digit represents multiplier (number of zeros to follow)

M

Tolerance
K = ±10%
M = ±20%

C

Case Size
See table above

□

Packaging
See Tape & Reel Packaging Section

TECHNICAL SPECIFICATIONS

Category Temperature Range:	-55 to +125°C
Rated Temperature:	+85°C
Capacitance Tolerance:	±20%, ±10% at 120Hz
Dissipation Factor:	Refer to next page
ESR 100kHz:	Refer to next page
Leakage Current:	After 1 minute's application of rated voltage, leakage current at 20°C is not more than 0.01CV or 0.5µA, whichever is greater. After 1 minute's application of rated voltage, leakage current at 85°C is not more than 0.1CV or 5µA, whichever is greater. After 1 minute's application of derated voltage, leakage current at 125°C is not more than 0.125CV or 6.3µA, whichever is greater.
Capacitance Change By Temperature	+15% Max. at +125°C +10% Max. at +85°C -10% Max. at -55°C

F91 Series



Low ESR, Resin-Molded Chip J-Lead

CAPACITANCE AND RATED VOLTAGE RANGE (LETTER DENOTES CASE SIZE)

Capacitance		Rated Voltage						
µF	Code	4V (0G)	6.3V (0J)	10V (1A)	16V (1C)	20V (1D)	25V (1E)	35V (1V)
6.8	685							C
10	106						C	N
15	156					C		N
22	226				B		N	N
33	336				B/C	N	N	
47	476			B	N	N	N	
68	686			C				
100	107		C	C	N			
150	157	C	C	N				
220	227	C	C/N	N				
330	337	N	N	N				
470	477	N	N					
680	687	N						

Available Ratings

RATINGS & PART NUMBER REFERENCE

AVX Part No.	Case Size	Capacitance (µF)	Rated Voltage (V)	DCL (µA)	DF @ 120Hz (%)	ESR @ 100kHz (mΩ)	100kHz RMS Current (mA) 20°C
4 Volt							
F910G157MCC	C	150	4	6.0	12	250	663
F910G227MCC	C	220	4	8.8	12	250	663
F910G337MNC	N	330	4	13.2	10	100	1225
F910G477MNC	N	470	4	18.8	16	100	1225
F910G687MNC	N	680	4	27.2	18	100	1225
6.3 Volt							
F910J107MCC	C	100	6.3	6.3	8	250	663
F910J157MCC	C	150	6.3	9.5	12	250	663
F910J227MCC	C	220	6.3	13.9	14	250	663
F910J227MNC	N	220	6.3	13.9	10	100	1225
F910J337MNC	N	330	6.3	20.8	14	100	1225
F910J477MNC	N	470	6.3	29.6	16	100	1225
10 Volt							
F911A476MBA	B	47	10	4.7	8	500	412
F911A686MCC	C	68	10	6.8	8	300	606
F911A107MCC	C	100	10	10.0	10	250	663
F911A157MNC	N	150	10	15.0	10	100	1225
F911A227MNC	N	220	10	22.0	12	100	1225
F911A337MNC	N	330	10	33.0	18	100	1225
16 Volt							
F911C226MBA	B	22	16	3.5	8	950	299
F911C336MBA	B	33	16	5.3	8	950	299
F911C336MCC	C	33	16	5.3	6	400	524
F911C476MNC	N	47	16	7.6	6	150	1000
F911C107MNC	N	100	16	16	10	100	1225
20 Volt							
F911D156MCC	C	15	20	3	6	450	494
F911D336MNC	N	33	20	6.6	6	200	866
F911D476MNC	N	47	20	9.4	8	200	866
25 Volt							
F911E106MCC	C	10	25	2.5	6	450	494
F911E226MNC	N	22	25	5.5	6	200	866
F911E336MNC	N	33	25	8.3	8	200	866
F911E476MNC	N	47	25	11.8	8	250	775
35 Volt							
F911V685MCC	C	6.8	35	2.4	6	600	428
F911V106MNC	N	10	35	3.5	6	300	707
F911V156MNC	N	15	35	5.3	6	300	707
F911V226MNC	N	22	35	7.7	8	300	707

* In case of capacitance tolerance ± 10% type, "K" will be put at 9th digit of type numbering system

F91 Series



Low ESR, Resin-Molded Chip J-Lead

QUALIFICATION TABLE

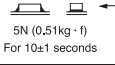
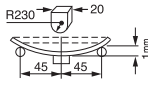
TEST	F91 series (Temperature range -55°C to +125°C)	
	Condition	
Damp Heat (Steady State)	At 40°C, 90 to 95% R.H., 500 hours (No voltage applied) Capacitance Change Within $\pm 10\%$ of the initial value Dissipation Factor Initial specified value or less Leakage Current Initial specified value or less	
Temperature Cycles	-55°C / +125°C, 30 minutes each, 5 cycles Capacitance Change Within $\pm 5\%$ of the initial value Dissipation Factor Initial specified value or less Leakage Current Initial specified value or less	
Resistance to Soldering Heat	10 seconds reflow at 260°C, 5 seconds immersion at 260°C. Capacitance Change Within $\pm 5\%$ of the initial value Dissipation Factor Initial specified value or less Leakage Current Initial specified value or less	
Surge	After application of surge voltage in series with a 33 Ω resistor at the rate of 30 seconds ON, 30 seconds OFF, for 1000 successive test cycles at 85°C, capacitors shall meet the characteristic requirements in the table above. Capacitance Change Within $\pm 5\%$ of the initial value Dissipation Factor Initial specified value or less Leakage Current Initial specified value or less	
Endurance	After 2000 hours' application of rated voltage in series with a 3 Ω resistor at 85°C, or derated voltage in series with a 3 Ω resistor at 125°C, capacitors shall meet the characteristic requirements in the table above. Capacitance Change Within $\pm 10\%$ of the initial value Dissipation Factor Initial specified value or less Leakage Current Initial specified value or less	
Shear Test	After applying the pressure load of 5N for 10 \pm 1 seconds horizontally to the center of capacitor side body which has no electrode and has been soldered beforehand on a substrate, there shall be found neither exfoliation nor its sign at the terminal electrode. 	
Terminal Strength	Keeping a capacitor surface-mounted on a substrate upside down and supporting the substrate at both of the opposite bottom points 45mm apart from the center of capacitor, the pressure strength is applied with a specified jig at the center of substrate so that the substrate may bend by 1mm as illustrated. Then, there shall be found no remarkable abnormality on the capacitor terminals. 	

F91-AJ6 Series



Low ESR, Resin-Molded Chip - Automotive Product Range



FEATURES

- Compliant to the RoHS2 directive 2011/65/EU
- Compliant to AEC-Q200



APPLICATIONS

- Cabin electronics
- Infotainment

CASE DIMENSIONS: millimeters (inches)

Code	EIA Code	EIA Metric	L	W ₁	W ₂	H	S
A	1206	3216-18	3.20 ± 0.20 (0.126 ± 0.008)	1.60 ± 0.20 (0.063 ± 0.008)	1.20 ± 0.10 (0.047 ± 0.004)	1.60 ± 0.20 (0.063 ± 0.008)	0.80 ± 0.20 (0.031 ± 0.008)
B	1210	3528-21	3.50 ± 0.20 (0.126 ± 0.008)	2.80 ± 0.20 (0.110 ± 0.008)	2.20 ± 0.10 (0.087 ± 0.004)	1.90 ± 0.20 (0.075 ± 0.008)	0.80 ± 0.20 (0.031 ± 0.008)
N	2917	7343-30	7.30 ± 0.20 (0.287 ± 0.008)	4.30 ± 0.20 (0.169 ± 0.008)	2.40 ± 0.10 (0.094 ± 0.004)	2.80 ± 0.20 (0.110 ± 0.008)	1.30 ± 0.20 (0.051 ± 0.008)

A, B CASE

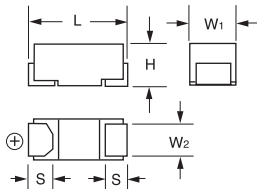

N CASE

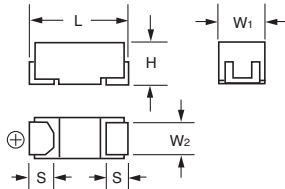

MARKING

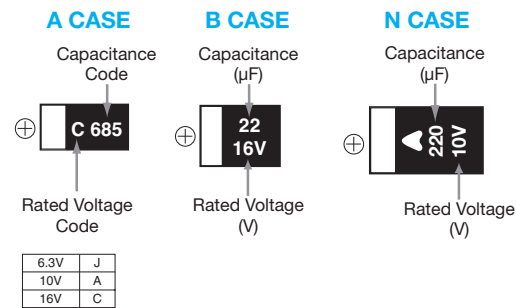

HOW TO ORDER

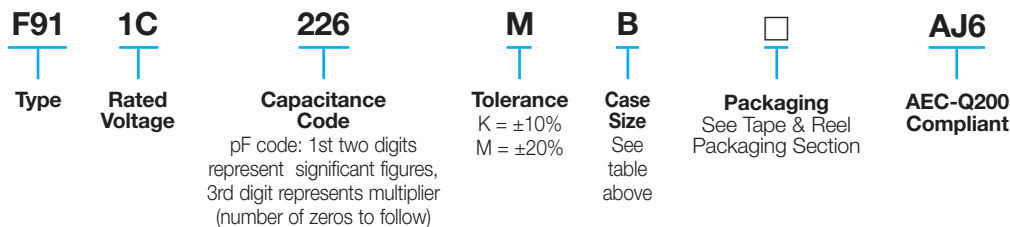

TECHNICAL SPECIFICATIONS

Category Temperature Range:	-55 to +125°C
Rated Temperature:	+85°C
Capacitance Tolerance:	±20%, ±10% at 120Hz
Dissipation Factor:	Refer to next page
ESR 100kHz:	Refer to next page
Leakage Current:	After 1 minute's application of rated voltage, leakage current at 20°C is not more than 0.01CV or 0.5µA, whichever is greater. After 1 minute's application of rated voltage, leakage current at 85°C is not more than 0.1CV or 5µA, whichever is greater. After 1 minute's application of derated voltage, leakage current at 125°C is not more than 0.125CV or 6.3µA, whichever is greater.
Capacitance Change By Temperature	+15% Max. at +125°C +10% Max. at +85°C -10% Max. at -55°C

F91-AJ6 Series



Low ESR, Resin-Molded Chip - Automotive Product Range

CAPACITANCE AND RATED VOLTAGE RANGE (LETTER DENOTES CASE SIZE)

Capacitance		Rated Voltage		
μF	Code	6.3V (0J)	10V (1A)	16V (1C)
10	106		A	A
22	226	A	A	B
33	336	A	B	B
47	476	B	B	
100	107			N

Available Ratings

RATINGS & PART NUMBER REFERENCE

AVX Part No.	Case Size	Capacitance (μF)	Rated Voltage (V)	DCL (μA)	DF @ 120Hz (%)	ESR @ 100kHz (mΩ)	100kHz RMS Current (mA) 20°C	*1 ΔC/C (%)
6.3 Volt								
F910J226MAAAJ6	A	22	6.3	1.4	8	1250	245	*
F910J336MAAAJ6	A	33	6.3	2.1	8	1250	245	*
F910J476MBAAJ6	B	47	6.3	3.0	6	500	412	*
10 Volt								
F911A106MAAAJ6	A	10	10	1.0	6	1500	224	*
F911A226MAAAJ6	A	22	10	2.2	12	1250	245	*
F911A336MBAAJ6	B	33	10	3.3	8	700	348	*
F911A476MBAAJ6	B	47	10	4.7	8	500	412	*
16 Volt								
F911C106MAAAJ6	A	10	16	1.6	6	1500	224	*
F911C226MBAAJ6	B	22	16	3.5	8	950	299	*
F911C336MBAAJ6	B	33	16	5.3	8	950	299	*
F911C107MNC AJ6	N	100	16	16.0	10	100	1225	*

* In case of capacitance tolerance ± 10% type, "K" will be put at 9th digit of type numbering system

1: ΔC/C Marked ""

Item	All Case (%)
Damp Heat	±10
Temperature cycles	±10
Resistance soldering heat	±10
Surge	±10
Endurance	±10

QUALIFICATION TABLE

TEST	F91-AJ6 series (Temperature range -55°C to +125°C)	
	Condition	
Damp Heat (Steady State)	At 40°C, 90 to 95% R.H., 500 hours (No voltage applied) Capacitance Change Refer to above (*1) Dissipation Factor Initial specified value or less Leakage Current Initial specified value or less	
Load Humidity	After 1000 hour's application of rated voltage in series with a 33Ω resistor at 85°C, 85% R.H., capacitors meet the characteristics requirements table below. Capacitance Change Refer to above (*1) Dissipation Factor Initial specified value or less Leakage Current 125% or less than the initial specified value	
Temperature Cycles	At -55°C / +125°C, 30 minutes each, 1000 cycles Capacitance Change Refer to above (*1) Dissipation Factor Initial specified value or less Leakage Current Initial specified value or less	
Resistance to Soldering Heat	10 seconds reflow at 260°C, 10 seconds immersion at 260°C. Capacitance Change Refer to above (*1) Dissipation Factor Initial specified value or less Leakage Current Initial specified value or less	
Surge	After application of surge voltage in series with a 33Ω resistor at the rate of 30 seconds ON, 30 seconds OFF, for 1000 successive test cycles at 85°C, capacitors shall meet the characteristic requirements in the table above. Capacitance Change Refer to above (*1) Dissipation Factor Initial specified value or less Leakage Current Initial specified value or less	
Endurance	After 2000 hours' application of rated voltage in series with a 3Ω resistor at 85°C, or derated voltage in series with a 3Ω resistor at 125°C, capacitors shall meet the characteristic requirements in the table above. Capacitance Change Refer to above (*1) Dissipation Factor Initial specified value or less Leakage Current Initial specified value or less	
Shear Test	After applying the pressure load of 17.7N for 60 seconds horizontally to the center of capacitor side body which has no electrode and has been soldered beforehand on a substrate, there shall be found neither exfoliation nor its sign at the terminal electrode.	
Terminal Strength	Keeping a capacitor surface-mounted on a substrate upside down and supporting the substrate at both of the opposite bottom points 45mm apart from the center of capacitor, the pressure strength is applied with a specified jig at the center of the substrate so that substrate may bend by 1mm as illustrated. Then, there shall be found no remarkable abnormality on the capacitor terminals.	
Failure Rate	1% per 1000 hours at 85°C, V _R with 0.1Ω/V series impedance, 60% confidence level.	

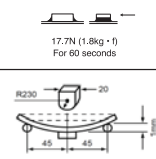

TPM Multianode



Tantalum Ultra Low ESR Capacitor



FEATURES

- Multi-anode construction
- Super low ESR
- CV range: 10-2200 μ F / 2.5-50V
- 4 case sizes available
- "Mirror" multi-anode construction used with D, Y case capacitors reduces ESL to half



SnPb termination option is not RoHS compliant.

APPLICATIONS

- High power DC/DC general applications

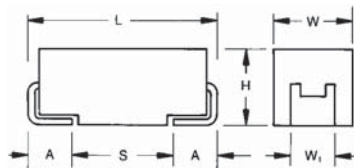

MULTIANODE CONSTRUCTION

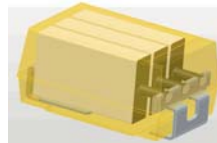

MULTIANODE TPM D, Y LOW SELF INDUCTANCE CONSTRUCTION "MIRROR" DESIGN

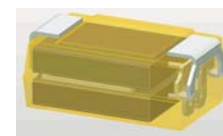

MARKING

D, E, V, Y CASE

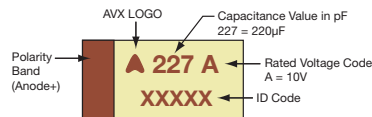

CASE DIMENSIONS: millimeters (inches)

Code	EIA Code	EIA Metric	L \pm 0.20 (0.008)	W \pm 0.20 (0.008) -0.10 (0.004)	H \pm 0.20 (0.008) -0.10 (0.004)	W $_1$ \pm 0.20 (0.008)	A \pm 0.30 (0.012) -0.20 (0.008)	S Min.
D	2917	7343-31	7.30 (0.287)	4.30 (0.169)	2.90 (0.114)	2.40 (0.094)	1.30 (0.051)	4.40 (0.173)
E	2917	7343-43	7.30 (0.287)	4.30 (0.169)	4.10 (0.162)	2.40 (0.094)	1.30 (0.051)	4.40 (0.173)
V	2924	7361-38	7.30 (0.287)	6.10 (0.240)	3.55 (0.140)	3.10 (0.120)	1.30 (0.051)	4.40 (0.173)
Y	2917	7343-20	7.30 (0.287)	4.30 (0.169)	2.00 (0.079) max	2.40 (0.094)	1.30 (0.051)	4.40 (0.173)

W1 dimension applies to the termination width for A dimensional area only.

HOW TO ORDER

TPM

Type

E

Case Size
See table above

108

Capacitance Code
pF code: 1st two digits represent significant figures, 3rd digit represents multiplier (number of zeros to follow)

M

Tolerance
K= \pm 10%
M= \pm 20%

004

Rated DC Voltage
002=2.5Vdc
004=4Vdc
006=6.3Vdc
010=10Vdc
016=16Vdc
020=20Vdc
025=25Vdc
035=35Vdc
050=50Vdc

R

Packaging
R = Pure Tin 7" Reel
S = Pure Tin 13" Reel
H = Tin Lead 7" Reel (Contact Manufacturer)
K = Tin Lead 13" Reel (Contact Manufacturer)
H, K = Non RoHS

0018

ESR in m Ω

TECHNICAL SPECIFICATIONS

Technical Data:	All technical data relate to an ambient temperature of +25°C										
Capacitance Range:	10 μ F to 2200 μ F										
Capacitance Tolerance:	\pm 10%, \pm 20%										
Rated Voltage (V _R)	\leq +85°C:	2.5	4	6.3	10	16	20	25	35	50	
Category Voltage (V _C)	\leq +125°C:	1.7	2.7	4	7	10	13	17	23	33	
Surge Voltage (V _S)	\leq +85°C:	3.3	5.2	8	13	20	26	32	46	65	
Surge Voltage (V _S)	\leq +125°C:	2.2	3.4	5	8	13	16	20	28	40	
Temperature Range:	-55°C to +125°C										
Reliability:	1% per 1000 hours at 85°C, V _R with 0.1 Ω /V series impedance, 60% confidence level										



TPM Multianode



Tantalum Ultra Low ESR Capacitor

CAPACITANCE AND RATED VOLTAGE RANGE (LETTER DENOTES CASE SIZE)

Capacitance		Rated Voltage DC (V _R) to 85°C								
μF	Code	2.5V (e)	4V (G)	6.3V (J)	10V (A)	16V (C)	20V (D)	25V (E)	35V (V)	50V (T)
6.8	685									
10	106									D(140) E(120)
15	156									E(75,100)
22	226								D(70) E(60,100)	E(75,100)
33	336							D(65)	E(50,65)	
47	476					D(100)	D(45,55)	D(55)/E(65)	E(55,65)	
68	686					D(40,50)	D(40,50)	E(45,55)		
100	107				Y(45) ^(M)	D(40,50)	E(35,45)			
150	157				Y(45) ^(M)	E(30,40)	E(35)			
220	227			Y(30) ^(M)	D(35)	E(25,40)				
330	337		D(25,35)	D(25,35)	D(35) E(23,35)	E(50)*				
470	477		D(25,35)	D(30) E(18,23,30)	E(23,30)					
680	687		D(25) E(18,23)	E(18,23) V(23)						
1000	108	D(25)	D(25,45) E(18,23), V(18)	E(25) ^(M) V(20) ^(M)						
1500	158	E(12,15,18)	E(15,18)							
2200	228	E(18) ^(M)								

Released ratings ^(M tolerance only), (ESR ratings in mOhms in parenthesis)

Engineering samples - please contact AVX

*Ratings under development - subject to change

Note: Voltage ratings are minimum values. AVX reserves the right to supply higher ratings in the same case size, to the same reliability standards.

TPM Multianode



Tantalum Ultra Low ESR Capacitor

RATINGS & PART NUMBER REFERENCE

AVX Part No.	Case Size	Capacitance (µF)	Rated Voltage (V)	Rated Temperature (°C)	Category Voltage (V)	Category Temperature (°C)	DCL Max. (µA)	DF Max. (%)	ESR Max. @ 100kHz (mΩ)	MSL	100kHz RMS Current (A)		
											25°C	85°C	125°C
2.5 Volt @ 85°C													
TPMD108*002#0025	D	1000	2.5	85	1.7	125	25	8	25	3	3.194	2.874	1.277
TPME158*002#0012	E	1500	2.5	85	1.7	125	38	6	12	3	4.743	4.269	1.897
TPME158*002#0015	E	1500	2.5	85	1.7	125	38	6	15	3	4.243	3.818	1.697
TPME158*002#0018	E	1500	2.5	85	1.7	125	38	6	18	3	3.873	3.486	1.549
TPME228M002#0018	E	2200	2.5	85	1.7	125	44	10	18	3	3.873	3.486	1.549
4 Volt @ 85°C													
TPMD337*004#0025	D	330	4	85	2.7	125	13.2	8	25	3	3.194	2.874	1.277
TPMD337*004#0035	D	330	4	85	2.7	125	13.2	8	35	3	2.699	2.429	1.080
TPMD477*004#0025	D	470	4	85	2.7	125	18.8	8	25	3	3.194	2.874	1.277
TPMD477*004#0035	D	470	4	85	2.7	125	18.8	8	35	3	2.699	2.429	1.080
TPMD687*004#0025	D	680	4	85	2.7	125	27.2	8	25	3	3.194	2.874	1.277
TPME687*004#0018	E	680	4	85	2.7	125	27	6	18	3	3.873	3.486	1.549
TPME687*004#0023	E	680	4	85	2.7	125	27	6	23	3	3.426	3.084	1.370
TPMD108*004#0025	D	1000	4	85	2.7	125	40	8	25	3	3.194	2.874	1.277
TPMD108*004#0045	D	1000	4	85	2.7	125	40	8	45	3	2.380	2.142	0.952
TPME108*004#0018	E	1000	4	85	2.7	125	40	6	18	3	3.873	3.486	1.549
TPME108*004#0023	E	1000	4	85	2.7	125	40	6	23	3	3.426	3.084	1.370
TPMV108*004#0018	V	1000	4	85	2.7	125	40	6	18	3	3.979	3.581	1.592
TPME158*004#0015	E	1500	4	85	2.7	125	40	6	15	3	4.243	3.818	1.697
TPME158*004#0018	E	1500	4	85	2.7	125	40	6	18	3	3.873	3.486	1.549
6.3 Volt @ 85°C													
TPMY227M006#0030	Y	220	6.3	85	4	125	13.2	6	30	3	2.646	2.381	1.058
TPMD337*006#0025	D	330	6.3	85	4	125	19.8	8	25	3	3.194	2.874	1.277
TPMD337*006#0035	D	330	6.3	85	4	125	19.8	8	35	3	2.699	2.429	1.080
TPMD477*006#0030	D	470	6.3	85	4	125	28.2	8	30	3	2.915	2.624	1.166
TPME477*006#0018	E	470	6.3	85	4	125	28	6	18	3	3.873	3.486	1.549
TPME477*006#0023	E	470	6.3	85	4	125	28	6	23	3	3.426	3.084	1.370
TPME477*006#0030	E	470	6.3	85	4	125	28	6	30	3	3.000	2.700	1.200
TPME687*006#0018	E	680	6.3	85	4	125	41	6	18	3	3.873	3.486	1.549
TPME687*006#0023	E	680	6.3	85	4	125	41	6	23	3	3.426	3.084	1.370
TPMV687*006#0023	V	680	6.3	85	4	125	41	6	23	3	3.520	3.168	1.408
TPME108M006#0025	E	1000	6.3	85	4	125	63	8	25	3	3.286	2.958	1.315
TPMV108M006#0020	V	1000	6.3	85	4	125	63	8	20	3	3.775	3.397	1.510
10 Volt @ 85°C													
TPMY107M010#0045	Y	100	10	85	7	125	10	8	45	3	2.160	1.944	0.864
TPMY157M010#0045	Y	150	10	85	7	125	15	8	45	3	2.160	1.944	0.864
TPMD227*010#0035	D	220	10	85	7	125	22	8	35	3	2.699	2.429	1.080
TPMD337*010#0035	D	330	10	85	7	125	33	8	35	3	2.699	2.429	1.080
TPME337*010#0023	E	330	10	85	7	125	33	6	23	3	3.426	3.084	1.370
TPME337*010#0035	E	330	10	85	7	125	33	6	35	3	2.777	2.500	1.111
TPME477*010#0023	E	470	10	85	7	125	47	6	23	3	3.426	3.084	1.370
TPME477*010#0030	E	470	10	85	7	125	47	6	30	3	3.000	2.700	1.200
16 Volt @ 85°C													
TPMD476*016#0100	D	47	16	85	10	125	7.5	8	100	3	1.597	1.437	0.639
TPMD686*016#0040	D	68	16	85	10	125	10.9	8	40	3	2.525	2.272	1.010
TPMD686*016#0050	D	68	16	85	10	125	10.9	8	50	3	2.258	2.032	0.903
TPMD107*016#0040	D	100	16	85	10	125	16	8	40	3	2.525	2.272	1.010
TPMD107*016#0050	D	100	16	85	10	125	16	8	50	3	2.258	2.032	0.903
TPME157*016#0030	E	150	16	85	10	125	24	6	30	3	3.000	2.700	1.200
TPME157*016#0040	E	150	16	85	10	125	24	6	40	3	2.598	2.338	1.039
TPME227*016#0025	E	220	16	85	10	125	35	6	25	3	3.286	2.958	1.315
TPME227*016#0040	E	220	16	85	10	125	35	6	40	3	2.598	2.338	1.039
20 Volt @ 85°C													
TPMD476*020#0045	D	47	20	85	13	125	9.4	8	45	3	2.380	2.142	0.952
TPMD476*020#0055	D	47	20	85	13	125	9.4	8	55	3	2.153	1.938	0.861
TPME107*020#0035	E	100	20	85	13	125	20	6	35	3	2.777	2.500	1.111
TPME107*020#0045	E	100	20	85	13	125	20	6	45	3	2.449	2.205	0.980
TPME157*020#0035	E	150	20	85	13	125	30	10	35	3	2.777	2.500	1.111
25 Volt @ 85°C													
TPMD336*025#0065	D	33	25	85	17	125	8.3	8	65	3	1.981	1.783	0.792
TPMD476*025#0055	D	47	25	85	17	125	11.8	8	55	3	2.153	1.938	0.861
TPME476*025#0065	E	47	25	85	17	125	11.8	6	65	3	2.038	1.834	0.815
TPME686*025#0045	E	68	25	85	17	125	17	6	45	3	2.449	2.205	0.980
TPME686*025#0055	E	68	25	85	17	125	17	6	55	3	2.216	1.994	0.886
35 Volt @ 85°C													
TPMD226*035#0070	D	22	35	85	23	125	7.7	8	70	3	1.909	1.718	0.763
TPME226*035#0060	E	22	35	85	23	125	8	6	60	3	2.121	1.909	0.849
TPME226*035#0100	E	22	35	85	23	125	8	6	100	3	1.643	1.479	0.657
TPME336*035#0050	E	33	35	85	23	125	12	6	50	3	2.324	2.091	0.930
TPME336*035#0065	E	33	35	85	23	125	12	6	65	3	2.038	1.834	0.815

TPM Multianode



Tantalum Ultra Low ESR Capacitor

RATINGS & PART NUMBER REFERENCE

AVX Part No.	Case Size	Capacitance (µF)	Rated Voltage (V)	Rated Temperature (°C)	Category Voltage (V)	Category Temperature (°C)	DCL Max. (µA)	DF Max. (%)	ESR Max. @ 100kHz (mΩ)	MSL	100kHz RMS Current (A)		
											25°C	85°C	125°C
TPME476*035#0055	E	47	35	85	23	125	16	6	55	3	2.216	1.994	0.886
TPME476*035#0065	E	47	35	85	23	125	16	6	65	3	2.038	1.834	0.815
50 Volt @ 85°C													
TPMD106*050#0140	D	10	50	85	33	125	5	8	140	3	1.350	1.215	0.540
TPME106*050#0120	E	10	50	85	33	125	5	6	120	3	1.500	1.350	0.600
TPME156*050#0075	E	15	50	85	33	125	7.5	6	75	3	1.897	1.708	0.759
TPME156*050#0100	E	15	50	85	33	125	7.5	6	100	3	1.643	1.479	0.657
TPME226*050#0075	E	22	50	85	33	125	11	8	75	3	1.897	1.708	0.759
TPME226*050#0100	E	22	50	85	33	125	11	8	100	3	1.643	1.479	0.657

Moisture Sensitivity Level (MSL) is defined according to J-STD-020

All technical data relates to an ambient temperature of +25°C. Capacitance and DF are measured at 120Hz, 0.5V RMS with a maximum DC bias of 2.2 volts.

DCL is measured at rated voltage after 5 minutes.

The EIA & CECC standards for low ESR Solid Tantalum Capacitors allow an ESR movement to 1.25 times catalogue limit post mounting.

For typical weight and composition see page 222.

NOTE: AVX reserves the right to supply a higher voltage rating or tighter tolerance part in the same case size, to the same reliability standards.

QUALIFICATION TABLE

TEST	TPM series (Temperature range -55°C to +125°C)										
	Condition			Characteristics							
Endurance	Determine after application of rated voltage for 2000 +48/-0 hours at 85±2°C and then leaving 1-2 hours at room temperature. Also determine of 125°C temperature, category voltage for 2000 +48/-0 hours and then leaving 1-2 hours at room temperature. Power supply impedance to be ≤0.1Ω/V.			Visual examination	no visible damage						
				DCL	initial limit						
				ΔC/C	within ±10% of initial value						
				DF	initial limit						
				ESR	1.25 x initial limit						
Humidity	Determine after storage without applied voltage at 65±2°C and 95±2% relative humidity for 500 hours and then recovery 1-2 hours at room temperature.			Visual examination	no visible damage						
				DCL	1.5 x initial limit						
				ΔC/C	within ±10% of initial value						
				DF	1.2 x initial limit						
				ESR	1.25 x initial limit						
Temperature Stability	Step	Temperature°C	Duration(min)		+20°C	-55°C	+20°C	+85°C	+125°C	+20°C	
	1	+20±2	15	DCL	IL*	n/a	IL*	10 x IL*	12.5 x IL*	IL*	
	2	-55+0/-3	15		ΔC/C	n/a	+0/-10%	±5%	+10/-0%	+12/-0%	±5%
	3	+20±2	15	DF		IL*	1.5 x IL*	IL*	1.5 x IL*	2 x IL*	IL*
	4	+85+3/-0	15		ESR	1.25 x IL*	2.5 x IL*	1.25 x IL*	1.25 x IL*	1.25 x IL*	1.25 x IL*
	5	+125+3/-0	15								
	6	+20±2	15								
Surge Voltage	Test temperature: 125°C±3/0°C Test voltage: Category voltage at 125°C Surge voltage: 1.3 x category voltage at 125°C Series protection resistance 1000±100Ω Discharge resistance: 1000Ω Number of cycles: 1000x Cycle duration: 6 min; 30 sec charge, 5 min 30 sec discharge			Visual examination	no visible damage						
				DCL	initial limit						
				ΔC/C	within ±5% of initial value						
				DF	initial limit						
				ESR	1.25 x initial limit						

*Initial Limit

Professional Tantalum Chip Capacitor



FEATURES

- Improved reliability – 2x standard
- DCL reduced by 25% to 0.0075 CV
- Robust against higher thermo-mechanical stresses during assembly process
- CV range: 0.10-680µF / 4-50V
- 6 case sizes available
- 130 low ESR parts released
- Automotive, medical, aerospace, military and other high-end applications



SnPb termination option is not RoHS compliant.

APPLICATIONS

- Automotive ECU
- ABS
- Airbag systems
- Avionics,
- Industrial control units

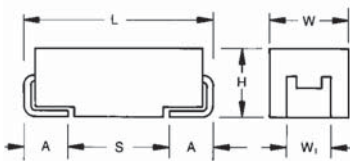

CASE DIMENSIONS: millimeters (inches)

Code	EIA Code	EIA Metric	L±0.20 (0.008)	W+0.20 (0.008) -0.10 (0.004)	H+0.20 (0.008) -0.10 (0.004)	W ₁ ±0.20 (0.008)	A+0.30 (0.012) -0.20 (0.008)	S Min.
A	1206	3216-18	3.20 (0.126)	1.60 (0.063)	1.60 (0.063)	1.20 (0.047)	0.80 (0.031)	1.10 (0.043)
B	1210	3528-21	3.50 (0.138)	2.80 (0.110)	1.90 (0.075)	2.20 (0.087)	0.80 (0.031)	1.40 (0.055)
C	2312	6032-28	6.00 (0.236)	3.20 (0.126)	2.60 (0.102)	2.20 (0.087)	1.30 (0.051)	2.90 (0.114)
D	2917	7343-31	7.30 (0.287)	4.30 (0.169)	2.90 (0.114)	2.40 (0.094)	1.30 (0.051)	4.40 (0.173)
E	2917	7343-43	7.30 (0.287)	4.30 (0.169)	4.10 (0.162)	2.40 (0.094)	1.30 (0.051)	4.40 (0.173)
U	2924	7361-43	7.30 (0.287)	6.10 (0.240)	4.10 (0.162)	3.10 (0.120)	1.30 (0.051)	4.40 (0.173)

W₁ dimension applies to the termination width for A dimensional area only.

MARKING

A, B, C, D, E, U CASE

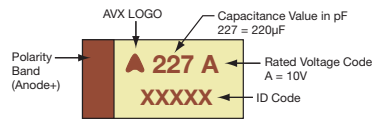

HOW TO ORDER

TRJ	B	105	*	035	R	RJ	—
Type	Case Size See table above	Capacitance Code pF code: 1st two digits represent significant figures, 3rd digit represents multiplier (number of zeros to follow)	Tolerance K=±10% M=±20%	Rated DC Voltage 004 = 4V 006 = 6.3V 010 = 10V 016 = 16V 020 = 20V 025 = 25V 035 = 35V 050 = 50V	Packaging R = Pure Tin 7" Reel S = Pure Tin 13" Reel A = Gold Plating 7" Reel (Contact Manufacturer) B = Gold Plating 13" Reel (Contact Manufacturer) H = Tin Lead 7" Reel (Contact Manufacturer) K = Tin Lead 13" Reel (Contact Manufacturer) H, K = Non RoHS	Standard Suffix OR 0100 Low ESR in mΩ	Additional characters may be added for special requirements V = Dry pack Option (selected codes only)

TECHNICAL SPECIFICATIONS

Technical Data:	All technical data relate to an ambient temperature of +25°C									
Capacitance Range:	0.10 µF to 680 µF									
Capacitance Tolerance:	±10%; ±20%									
Leakage Current DCL:	0.0075CV or 0.3µA whichever is the greater									
Rated Voltage (V _R)	≤ +85°C:	4	6.3	10	16	20	25	35	50	
Category Voltage (V _C)	≤ +125°C:	2.7	4	7	10	13	17	23	33	
Surge Voltage (V _S)	≤ +85°C:	5.2	8	13	20	26	32	46	65	
Surge Voltage (V _S)	≤ +125°C:	3.4	5	8	13	16	20	28	40	
Temperature Range:	-55°C to +125°C									
Reliability:	0.5% per 1000 hours at 85°C, V _R with 0.1Ω/V series impedance, 60% confidence level									
Termination Plating:	Sn Plating (standard), Gold and SnPb Plating upon request Meets requirements of AEC-Q200									

Professional Tantalum Chip Capacitor

CAPACITANCE AND RATED VOLTAGE RANGE (LETTER DENOTES CASE SIZE)

Capacitance		Rated Voltage DC (V_R) to 85°C							
μF	Code	4V (G)	6.3V (J)	10V (A)	16V (C)	20V (D)	25V (E)	35V (V)	50V (T)
0.10	104							A	
0.15	154							A, A(6000)	
0.22	224							A, A(6000)	A, A(7000)
0.33	334							A, A(6000)	A
0.47	474						A, A(7000)	A, A(4000)	B
0.68	684						A, A(6000)	A, A(6000)	B, B(2000)
1.0	105				A	A, A(3000)	A, A(3000)	A, B, A(3000), B(2000)	C, B, B(2000)
1.5	155			A		A, A(3000)	A, B, A(3000)	A, B, A(2000), B(2500)	C, C(1500)
2.2	225			A	A, A(3500)	A, A(3000)	A, B, A(1600), B(1200)	B, B(2000)	C, D, C(1000), D(1200)
3.3	335				A, B, A(3500)	A, B, A(2500), B(1300)	B, B(2000)	B, C, D, B(1000), C(800)	C, D, C(1000), D(800)
4.7	475			A, A(2000)	A, B, A(2000), B(1500)	A, B, A(1800), B(1000)	B, B(1000)	B, C, D, B(1500), C(600)	D, D(600)
6.8	685			A, B, A(1800)	A, B, C, A(1500), B(1200)	B, C, B(1000)	B, C, B(1000), C(600)	C, D, C(600)	D
10	106		A, B, A(1500)	A, B, A(1800), B(800)	B, C, B(800)	B, C, B(1000), C(500)	C, D, C(600)	C, D, C(600), D(250,400)	E, E(300,400)
15	156	B	A, B, A(1500), B(700)	A, B, C, A(1000), B(600)	B, B(800)	B, C, D, B(500), C(400)	C, D, C(500), D(300)	D, D(225)	U
22	226		A, B, C, A(900), B(600)	B, B(700)	B, C, D, B(600), C(350)	C, D, C(400), D(150,300)	D, D(300)	D, D(200,400)	U
33	336	C	B, C, B(600)	B, C, D, B(650), C(300)	C, C(300)	C, D, C(300), D(250)	D, D(400)	E, E(150,250)	
47	476		B, C, B(500), C(250)	C, D, C(300)	C, D, C(350), D(200)	D, D(200)	D, E, D(250), E(150)	U, U(200)	
68	686		C, C(200)	C, C(300)	C, D, C(200), D(150)	D, E, D(200), E(120,200)	U		
100	107		C, C(300)	C, D, E, C(200), D(100,150), E(100)	D, E, D(150), E(150)	E, E(150)	U		
150	157		C, D, C(300), D(150)	D, E, D(150), E(150)	E, E(150)	U, U(250)			
220	227		D, D(150)	D, E, E(150)	U, U(200)				
330	337		D, E, E(150)	E, E(100)	U, U(200)				
470	477		E, E(200)	U, U(200)					
680	687		U, U(250)						

Not recommended for new designs; higher voltage or smaller case size alternatives are available.

Released ratings, (ESR ratings in mOhms in parenthesis)

Engineering samples - please contact AVX

*Ratings under development – subject to change.

Note: Voltage ratings are minimum values. AVX reserves the right to supply higher ratings in the same case size, to the same reliability standards.

RATINGS & PART NUMBER REFERENCE

AVX Part No.	Case Size	Capacitance (µF)	Rated Voltage (V)	Rated Temperature (°C)	Category Voltage (V)	Category Temperature (°C)	DCL Max. (µA)	DF Max. (%)	ESR Max. @ 100kHz (mΩ)	MSL	100kHz RMS Current (mA)		
											25°C	85°C	125°C
4 Volt @ 85°C													
TRJB156*004#RJ	B	15	4	85	2.7	125	0.45	6	3000	1	168	151	67
TRJC336*004#RJ	C	33	4	85	2.7	125	1	6	2000	1	235	211	94
6.3 Volt @ 85°C													
TRJA106*006#RJ	A	10	6.3	85	4	125	0.45	6	2200	1	185	166	74
TRJA106*006#1500	A	10	6.3	85	4	125	0.45	6	1500	1	224	201	89
TRJB106*006#RJ	B	10	6.3	85	4	125	0.45	6	3000	1	168	151	67
TRJA156*006#RJ	A	15	6.3	85	4	125	0.68	6	2030	1	192	173	77
TRJA156*006#1500	A	15	6.3	85	4	125	0.68	6	1500	1	224	201	89
TRJB156*006#RJ	B	15	6.3	85	4	125	0.68	6	2030	1	205	184	82
TRJB156*006#0700	B	15	6.3	85	4	125	0.68	6	700	1	348	314	139
TRJA226*006#RJ	A	22	6.3	85	4	125	0.99	6	1700	1	210	189	84
TRJA226*006#0900	A	22	6.3	85	4	125	0.99	6	900	1	289	260	115
TRJB226*006#RJ	B	22	6.3	85	4	125	0.99	6	1880	1	213	191	85
TRJB226*006#0600	B	22	6.3	85	4	125	0.99	6	600	1	376	339	151
TRJC226*006#RJ	C	22	6.3	85	4	125	0.99	6	2000	1	235	211	94
TRJB336*006#RJ	B	33	6.3	85	4	125	1.5	6	1740	1	221	199	88
TRJB336*006#0600	B	33	6.3	85	4	125	1.5	6	600	1	376	339	151
TRJC336*006#RJ	C	33	6.3	85	4	125	1.5	6	1800	1	247	222	99
TRJB476*006#RJ	B	47	6.3	85	4	125	2.1	6	1620	1	229	206	92
TRJB476*006#0500	B	47	6.3	85	4	125	2.1	6	500	1	412	371	165
TRJC476*006#RJ	C	47	6.3	85	4	125	2.1	6	540	1	451	406	181
TRJC476*006#0250	C	47	6.3	85	4	125	2.1	6	250	1	663	597	265
TRJC686*006#RJ	C	68	6.3	85	4	125	3.1	6	490	1	474	426	190
TRJC686*006#0200	C	68	6.3	85	4	125	3.1	6	200	1	742	667	297
TRJC107*006#RJ	C	100	6.3	85	4	125	4.5	6	440	1	500	450	200
TRJC107*006#0300	C	100	6.3	85	4	125	4.5	6	300	1	606	545	242
TRJC157*006#RJ	C	150	6.3	85	4	125	6.8	8	500	1	469	422	188
TRJC157*006#0300	C	150	6.3	85	4	125	6.8	8	300	1	606	545	242
TRJD157*006#RJ	D	150	6.3	85	4	125	6.8	6	400	1	612	551	245
TRJD157*006#0150	D	150	6.3	85	4	125	6.8	6	150	1	1000	900	400
TRJD227*006#RJ	D	220	6.3	85	4	125	9.9	8	360	1	645	581	258
TRJD227*006#0150	D	220	6.3	85	4	125	9.9	8	150	1	1000	900	400
TRJD337*006#RJ	D	330	6.3	85	4	125	14	8	400	1	612	551	245
TRJE337*006#RJ	E	330	6.3	85	4	125	14	8	330	1 ¹⁾	707	636	283
TRJE337*006#0150	E	330	6.3	85	4	125	14	8	150	1 ¹⁾	1049	944	420
TRJE477*006#RJ	E	470	6.3	85	4	125	21	8	250	1 ¹⁾	812	731	325
TRJE477*006#0200	E	470	6.3	85	4	125	21	8	200	1 ¹⁾	908	817	363
TRJU687*006#RJ	U	680	6.3	85	4	125	30	30	500	3	574	517	230
TRJU687*006#R0250V	U	680	6.3	85	4	125	30	30	250	3	812	731	325
10 Volt @ 85°C													
TRJA155*010#RJ	A	1.5	10	85	7	125	0.3	6	7000	1	104	93	41
TRJA225*010#RJ	A	2.2	10	85	7	125	0.3	6	7000	1	104	93	41
TRJA475*010#RJ	A	4.7	10	85	7	125	0.35	6	2900	1	161	145	64
TRJA475*010#2000	A	4.7	10	85	7	125	0.35	6	2000	1	194	174	77
TRJA685*010#RJ	A	6.8	10	85	7	125	0.51	6	2650	1	168	151	67
TRJA685*010#1800	A	6.8	10	85	7	125	0.51	6	1800	1	204	184	82
TRJB685*010#RJ	B	6.8	10	85	7	125	0.51	6	3000	1	168	151	67
TRJA106*010#RJ	A	10	10	85	7	125	0.75	6	2200	1	185	166	74
TRJA106*010#1800	A	10	10	85	7	125	0.75	6	1800	1	204	184	82
TRJB106*010#RJ	B	10	10	85	7	125	0.75	6	2200	1	197	177	79
TRJB106*010#0800	B	10	10	85	7	125	0.75	6	800	1	326	293	130
TRJA156*010#RJ	A	15	10	85	7	125	1.1	6	1800	1	204	184	82
TRJA156*010#1000	A	15	10	85	7	125	1.1	6	1000	1	274	246	110
TRJB156*010#RJ	B	15	10	85	7	125	1.1	6	2030	1	205	184	82
TRJB156*010#0600	B	15	10	85	7	125	1.1	6	600	1	376	339	151
TRJC156*010#RJ	C	15	10	85	7	125	1.1	6	2000	1	235	211	94
TRJB226*010#RJ	B	22	10	85	7	125	1.7	6	1880	1	213	191	85
TRJB226*010#0700	B	22	10	85	7	125	1.7	6	700	1	348	314	139
TRJB336*010#RJ	B	33	10	85	7	125	2.5	6	1000	1	292	262	117
TRJB336*010#0650	B	33	10	85	7	125	2.5	6	650	1	362	325	145
TRJC336*010#RJ	C	33	10	85	7	125	2.5	6	590	1	432	389	173
TRJC336*010#0300	C	33	10	85	7	125	2.5	6	300	1	606	545	242
TRJD336*010#RJ	D	33	10	85	7	125	2.5	6	1100	1	369	332	148
TRJC476*010#RJ	C	47	10	85	7	125	3.5	6	540	1	451	406	181
TRJC476*010#0300	C	47	10	85	7	125	3.5	6	300	1	606	545	242
TRJD476*010#RJ	D	47	10	85	7	125	3.5	6	400	1	612	551	245
TRJC686*010#RJ	C	68	10	85	7	125	5.1	6	490	1	474	426	190
TRJC686*010#0300	C	68	10	85	7	125	5.1	6	300	1	606	545	242
TRJC107*010#RJ	C	100	10	85	7	125	7.5	8	500	1	469	422	188
TRJC107*010#0200	C	100	10	85	7	125	7.5	8	200	1	742	667	297

TRJ Series



Professional Tantalum Chip Capacitor

RATINGS & PART NUMBER REFERENCE

AVX Part No.	Case Size	Capacitance (μF)	Rated Voltage (V)	Rated Temperature (°C)	Category Voltage (V)	Category Temperature (°C)	DCL Max. (μA)	DF Max. (%)	ESR Max. @ 100kHz (mΩ)	MSL	100kHz RMS Current (mA)		
											25°C	85°C	125°C
TRJD107*010#RJ	D	100	10	85	7	125	7.5	6	440	1	584	525	234
TRJD107*010#0100	D	100	10	85	7	125	7.5	6	100	1	1225	1102	490
TRJD107*010#0150	D	100	10	85	7	125	7.5	6	150	1	1000	900	400
TRJE107*010#RJ	E	100	10	85	7	125	7.5	6	440	1 ¹⁾	612	551	245
TRJE107*010#0100	E	100	10	85	7	125	7.5	6	100	1 ¹⁾	1285	1156	514
TRJD157*010#RJ	D	150	10	85	7	125	11	8	400	1	612	551	245
TRJD157*010#0150	D	150	10	85	7	125	11	8	150	1	1000	900	400
TRJE157*010#RJ	E	150	10	85	7	125	11	8	400	1 ¹⁾	642	578	257
TRJE157*010#0150	E	150	10	85	7	125	11	8	150	1 ¹⁾	1049	944	420
TRJD227*010#RJ	D	220	10	85	7	125	17	8	500	1	548	493	219
TRJE227*010#RJ	E	220	10	85	7	125	17	8	360	1 ¹⁾	677	609	271
TRJE227*010#0150	E	220	10	85	7	125	17	8	150	1 ¹⁾	1049	944	420
TRJE337*010#RJ	E	330	10	85	7	125	25	8	300	1 ¹⁾	742	667	297
TRJE337*010#0100	E	330	10	85	7	125	25	8	100	1 ¹⁾	1285	1156	514
TRJU477*010RFRJV	U	470	10	85	7	125	35	30	400	3	642	578	257
TRJU477*010R0200V	U	470	10	85	7	125	35	30	200	3	908	817	363
16 Volt @ 85°C													
TRJA105*016#RJ	A	1.0	16	85	10	125	0.3	6	10000	1	87	78	35
TRJA225*016#RJ	A	2.2	16	85	10	125	0.3	6	4550	1	128	116	51
TRJA225*016#3500	A	2.2	16	85	10	125	0.3	6	3500	1	146	132	59
TRJA335*016#RJ	A	3.3	16	85	10	125	0.4	6	3740	1	142	127	57
TRJA335*016#3500	A	3.3	16	85	10	125	0.4	6	3500	1	146	132	59
TRJB335*016#RJ	B	3.3	16	85	10	125	0.4	6	4500	1	137	124	55
TRJA475*016#RJ	A	4.7	16	85	10	125	0.56	6	3160	1	154	139	62
TRJA475*016#2000	A	4.7	16	85	10	125	0.56	6	2000	1	194	174	77
TRJB475*016#RJ	B	4.7	16	85	10	125	0.56	6	3160	1	164	148	66
TRJB475*016#1500	B	4.7	16	85	10	125	0.56	6	1500	1	238	214	95
TRJA685*016#RJ	A	6.8	16	85	10	125	0.82	4	2000	1	194	174	77
TRJA685*016#1500	A	6.8	16	85	10	125	0.82	4	1500	1	224	201	89
TRJB685*016#RJ	B	6.8	16	85	10	125	0.82	6	2650	1	179	161	72
TRJB685*016#1200	B	6.8	16	85	10	125	0.82	6	1200	1	266	240	106
TRJC685*016#RJ	C	6.8	16	85	10	125	0.82	6	2500	1	210	189	84
TRJB106*016#RJ	B	10	16	85	10	125	1.2	6	2200	1	197	177	79
TRJB106*016#0800	B	10	16	85	10	125	1.2	6	800	1	326	293	130
TRJC106*016#RJ	C	10	16	85	10	125	1.2	6	2000	1	235	211	94
TRJB156*016#RJ	B	15	16	85	10	125	1.8	6	2030	1	205	184	82
TRJB156*016#0800	B	15	16	85	10	125	1.8	6	800	1	326	293	130
TRJB226*016#RJ	B	22	16	85	10	125	2.6	6	1100	1	278	250	111
TRJB226*016#0600	B	22	16	85	10	125	2.6	6	600	1	376	339	151
TRJC226*016#RJ	C	22	16	85	10	125	2.6	6	700	1	396	357	159
TRJC226*016#0350	C	22	16	85	10	125	2.6	6	350	1	561	505	224
TRJD226*016#RJ	D	22	16	85	10	125	2.6	6	1100	1	369	332	148
TRJC336*016#RJ	C	33	16	85	10	125	4	6	590	1	432	389	173
TRJC336*016#0300	C	33	16	85	10	125	4	6	300	1	606	545	242
TRJC476*016#RJ	C	47	16	85	10	125	5.6	6	540	1	451	406	181
TRJC476*016#0350	C	47	16	85	10	125	5.6	6	350	1	561	505	224
TRJD476*016#RJ	D	47	16	85	10	125	5.6	6	540	1	527	474	211
TRJD476*016#0200	D	47	16	85	10	125	5.6	6	200	1	866	779	346
TRJC686*016#RJ	C	68	16	85	10	125	8.2	6	490	1	474	426	190
TRJC686*016#0200	C	68	16	85	10	125	8.2	6	200	1	742	667	297
TRJD686*016#RJ	D	68	16	85	10	125	8.2	6	490	1	553	498	221
TRJD686*016#0150	D	68	16	85	10	125	8.2	6	150	1	1000	900	400
TRJD107*016#RJ	D	100	16	85	10	125	12	6	440	1	584	525	234
TRJD107*016#0150	D	100	16	85	10	125	12	6	150	1	1000	900	400
TRJE107*016#RJ	E	100	16	85	10	125	12	6	440	1 ¹⁾	612	551	245
TRJE107*016#0150	E	100	16	85	10	125	12	6	150	1 ¹⁾	1049	944	420
TRJE157*016#RJ	E	150	16	85	10	125	16	6	300	1 ¹⁾	742	667	297
TRJE157*016#0150	E	150	16	85	10	125	16	6	150	1 ¹⁾	1049	944	420
TRJU227*016RFRJV	U	220	16	85	10	125	26.4	12	500	3	574	517	230
TRJU227*016R0200V	U	220	16	85	10	125	26.4	12	200	3	908	817	363
TRJU337*016RFRJV	U	330	16	85	10	125	39	30	400	3	642	578	257
TRJU337*016R0200V	U	330	16	85	10	125	39	30	200	3	908	817	363
20 Volt @ 85°C													
TRJA105*020#RJ	A	1	20	85	13	125	0.3	4	6630	1	106	96	43
TRJA105*020#3000	A	1	20	85	13	125	0.3	4	3000	1	158	142	63
TRJA155*020#RJ	A	1.5	20	85	13	125	0.3	6	5460	1	117	105	47
TRJA155*020#3000	A	1.5	20	85	13	125	0.3	6	3000	1	158	142	63
TRJA225*020#RJ	A	2.2	20	85	13	125	0.33	6	4550	1	128	116	51
TRJA225*020#3000	A	2.2	20	85	13	125	0.33	6	3000	1	158	142	63
TRJA335*020#RJ	A	3.3	20	85	13	125	0.5	6	3740	1	142	127	57
TRJA335*020#2500	A	3.3	20	85	13	125	0.5	6	2500	1	173	156	69

RATINGS & PART NUMBER REFERENCE

AVX Part No.	Case Size	Capacitance (µF)	Rated Voltage (V)	Rated Temperature (°C)	Category Voltage (V)	Category Temperature (°C)	DCL Max. (µA)	DF Max. (%)	ESR Max. @ 100kHz (mΩ)	MSL	100kHz RMS Current (mA)		
											25°C	85°C	125°C
TRJB335*020#RJ	B	3.3	20	85	13	125	0.5	6	3740	1	151	136	60
TRJB335*020#1300	B	3.3	20	85	13	125	0.5	6	1300	1	256	230	102
TRJA475*020#RJ	A	4.7	20	85	13	125	0.71	5	2500	1	184	166	74
TRJA475*020#1800	A	4.7	20	85	13	125	0.71	5	1800	1	217	196	87
TRJB475*020#RJ	B	4.7	20	85	13	125	0.71	6	3160	1	164	148	66
TRJB475*020#1000	B	4.7	20	85	13	125	0.71	6	1000	1	292	262	117
TRJB685*020#RJ	B	6.8	20	85	13	125	1	6	2650	1	179	161	72
TRJB685*020#1000	B	6.8	20	85	13	125	1	6	1000	1	292	262	117
TRJC685*020#RJ	C	6.8	20	85	13	125	1	6	2000	1	235	211	94
TRJB106*020#RJ	B	10	20	85	13	125	1.5	6	2200	1	197	177	79
TRJB106*020#1000	B	10	20	85	13	125	1.5	6	1000	1	292	262	117
TRJC106*020#RJ	C	10	20	85	13	125	1.5	6	800	1	371	334	148
TRJC106*020#0500	C	10	20	85	13	125	1.5	6	500	1	469	422	188
TRJB156*020#RJ	B	15	20	85	13	125	2.3	6	1400	1	280	252	112
TRJB156*020#0500	B	15	20	85	13	125	2.3	6	500	1	469	422	188
TRJC156*020#RJ	C	15	20	85	13	125	2.3	6	720	1	391	352	156
TRJC156*020#0400	C	15	20	85	13	125	2.3	6	400	1	524	472	210
TRJD156*020#RJ	D	15	20	85	13	125	2.3	6	1100	1	369	332	148
TRJC226*020#RJ	C	22	20	85	13	125	3.3	6	650	1	411	370	165
TRJC226*020#0400	C	22	20	85	13	125	3.3	6	400	1	524	472	210
TRJD226*020#RJ	D	22	20	85	13	125	3.3	6	650	1	480	432	192
TRJD226*020#0150	D	22	20	85	13	125	3.3	6	150	1	1000	900	400
TRJD226*020#0300	D	22	20	85	13	125	3.3	6	300	1	707	636	283
TRJC336*020#RJ	C	33	20	85	13	125	5	6	590	1	432	389	173
TRJC336*020#0300	C	33	20	85	13	125	5	6	300	1	606	545	242
TRJD336*020#RJ	D	33	20	85	13	125	5	6	590	1	504	454	202
TRJD336*020#0250	D	33	20	85	13	125	5	6	250	1	775	697	310
TRJD476*020#RJ	D	47	20	85	13	125	7.1	6	540	1	527	474	211
TRJD476*020#0200	D	47	20	85	13	125	7.1	6	200	1	866	779	346
TRJD686*020#RJ	D	68	20	85	13	125	10	6	490	1	553	498	221
TRJD686*020#0200	D	68	20	85	13	125	10	6	200	1	866	779	346
TRJE686*020#RJ	E	68	20	85	13	125	10	6	490	1 ¹⁾	580	522	232
TRJE686*020#0120	E	68	20	85	13	125	10	6	120	1 ¹⁾	1173	1055	469
TRJE686*020#0200	E	68	20	85	13	125	10	6	200	1 ¹⁾	908	817	363
TRJE107*020#RJ	E	100	20	85	13	125	15	6	300	1 ¹⁾	742	667	297
TRJE107*020#0150	E	100	20	85	13	125	15	6	150	1 ¹⁾	1049	944	420
TRJU157*020#RRJV	U	150	20	85	13	125	22	30	500	3	574	517	230
TRJU157*020#R0250V	U	150	20	85	13	125	22	30	250	3	812	731	325
25 Volt @ 85°C													
TRJA474*025#RJ	A	0.47	25	85	17	125	0.3	4	9530	1	89	80	35
TRJA474*025#7000	A	0.47	25	85	17	125	0.3	4	7000	1	104	93	41
TRJA684*025#RJ	A	0.68	25	85	17	125	0.3	4	7980	1	97	87	39
TRJA684*025#6000	A	0.68	25	85	17	125	0.3	4	6000	1	112	101	45
TRJA105*025#RJ	A	1	25	85	17	125	0.3	4	6630	1	106	96	43
TRJA105*025#3000	A	1	25	85	17	125	0.3	4	3000	1	158	142	63
TRJA155*025#RJ	A	1.5	25	85	17	125	0.3	6	5460	1	117	105	47
TRJA155*025#3000	A	1.5	25	85	17	125	0.3	6	3000	1	158	142	63
TRJB155*025#RJ	B	1.5	25	85	17	125	0.3	6	5000	1	130	117	52
TRJA225*025#RJ	A	2.2	25	85	17	125	0.41	6	2900	1	161	145	64
TRJA225*025#1600	A	2.2	25	85	17	125	0.41	6	1600	1	217	195	87
TRJB225*025#RJ	B	2.2	25	85	17	125	0.41	6	4550	1	137	123	55
TRJB225*025#1200	B	2.2	25	85	17	125	0.41	6	1200	1	266	240	106
TRJB335*025#RJ	B	3.3	25	85	17	125	0.62	6	3740	1	151	136	60
TRJB335*025#2000	B	3.3	25	85	17	125	0.62	6	2000	1	206	186	82
TRJB475*025#RJ	B	4.7	25	85	17	125	0.88	6	3160	1	164	148	66
TRJB475*025#1000	B	4.7	25	85	17	125	0.88	6	1000	1	292	262	117
TRJB685*025#RJ	B	6.8	25	85	17	125	1.3	6	1500	1	238	214	95
TRJB685*025#1000	B	6.8	25	85	17	125	1.3	6	1000	1	292	262	117
TRJC685*025#RJ	C	6.8	25	85	17	125	1.3	6	1070	1	321	289	128
TRJC685*025#0600	C	6.8	25	85	17	125	1.3	6	600	1	428	385	171
TRJC106*025#RJ	C	10	25	85	17	125	1.9	6	800	1	371	334	148
TRJC106*025#0600	C	10	25	85	17	125	1.9	6	600	1	428	385	171
TRJD106*025#RJ	D	10	25	85	17	125	1.9	6	1200	1	354	318	141
TRJC156*025#RJ	C	15	25	85	17	125	2.8	6	720	1	391	352	156
TRJC156*025#0500	C	15	25	85	17	125	2.8	6	500	1	469	422	188
TRJD156*025#RJ	D	15	25	85	17	125	2.8	6	720	1	456	411	183
TRJD156*025#0300	D	15	25	85	17	125	2.8	6	300	1	707	636	283
TRJD226*025#RJ	D	22	25	85	17	125	4.1	6	650	1	480	432	192
TRJD226*025#0300	D	22	25	85	17	125	4.1	6	300	1	707	636	283
TRJD336*025#RJ	D	33	25	85	17	125	6.2	6	590	1	504	454	202
TRJD336*025#0400	D	33	25	85	17	125	6.2	6	400	1	612	551	245

TRJ Series



Professional Tantalum Chip Capacitor

RATINGS & PART NUMBER REFERENCE

AVX Part No.	Case Size	Capacitance (µF)	Rated Voltage (V)	Rated Temperature (°C)	Category Voltage (V)	Category Temperature (°C)	DCL Max. (µA)	DF Max. (%)	ESR Max. @ 100kHz (mΩ)	MSL	100kHz RMS Current (mA)		
											25°C	85°C	125°C
TRJD476*025#RJ	D	47	25	85	17	125	8.8	6	540	1	527	474	211
TRJD476*025#0250	D	47	25	85	17	125	8.8	6	250	1	775	697	310
TRJE476*025#RJ	E	47	25	85	17	125	8.8	6	540	1 ¹⁾	553	497	221
TRJE476*025#0150	E	47	25	85	17	125	8.8	6	150	1 ¹⁾	1049	944	420
TRJU686*025RRJV	U	68	25	85	17	125	12	30	500	3	574	517	230
TRJU107*025RRJV	U	100	25	85	17	125	18	30	500	3	574	517	230
35 Volt @ 85°C													
TRJA104*035#RJ	A	0.1	35	85	23	125	0.3	4	20000	1	61	55	24
TRJA154*035#RJ	A	0.15	35	85	23	125	0.3	4	16470	1	67	61	27
TRJA154*035#6000	A	0.15	35	85	23	125	0.3	4	6000	1	112	101	45
TRJA224*035#RJ	A	0.22	35	85	23	125	0.3	4	13710	1	74	67	30
TRJA224*035#6000	A	0.22	35	85	23	125	0.3	4	6000	1	112	101	45
TRJA334*035#RJ	A	0.33	35	85	23	125	0.3	4	11280	1	82	73	33
TRJA334*035#6000	A	0.33	35	85	23	125	0.3	4	6000	1	112	101	45
TRJA474*035#RJ	A	0.47	35	85	23	125	0.3	4	9530	1	89	80	35
TRJA474*035#4000	A	0.47	35	85	23	125	0.3	4	4000	1	137	123	55
TRJA684*035#RJ	A	0.68	35	85	23	125	0.3	4	7980	1	97	87	39
TRJA684*035#6000	A	0.68	35	85	23	125	0.3	4	6000	1	112	101	45
TRJA105*035#RJ	A	1	35	85	23	125	0.3	4	6630	1	106	96	43
TRJA105*035#3000	A	1	35	85	23	125	0.3	4	3000	1	158	142	63
TRJB105*035#RJ	B	1	35	85	23	125	0.3	4	3400	1	158	142	63
TRJB105*035#2000	B	1	35	85	23	125	0.3	4	2000	1	206	186	82
TRJA155*035#RJ	A	1.5	35	85	23	125	0.39	6	3100	1	166	149	66
TRJA155*035#2000	A	1.5	35	85	23	125	0.39	6	2000	1	206	186	82
TRJB155*035#RJ	B	1.5	35	85	23	125	0.39	6	5460	1	125	112	50
TRJB155*035#2500	B	1.5	35	85	23	125	0.39	6	2500	1	184	166	74
TRJB225*035#RJ	B	2.2	35	85	23	125	0.58	6	4550	1	137	123	55
TRJB225*035#2000	B	2.2	35	85	23	125	0.58	6	2000	1	206	186	82
TRJB335*035#RJ	B	3.3	35	85	23	125	0.87	6	3740	1	151	136	60
TRJB335*035#1000	B	3.3	35	85	23	125	0.87	6	1000	1	292	262	117
TRJC335*035#RJ	C	3.3	35	85	23	125	0.87	6	1840	1	245	220	98
TRJC335*035#8000	C	3.3	35	85	23	125	0.87	6	800	1	371	334	148
TRJD335*035#RJ	D	3.3	35	85	23	125	0.87	6	2000	1	274	246	110
TRJB475*035#RJ	B	4.7	35	85	23	125	1.2	6	2200	1	224	201	89
TRJB475*035#1500	B	4.7	35	85	23	125	1.2	6	1500	1	271	244	108
TRJC475*035#RJ	C	4.7	35	85	23	125	1.2	6	1410	1	279	251	112
TRJC475*035#0600	C	4.7	35	85	23	125	1.2	6	600	1	428	385	171
TRJD475*035#RJ	D	4.7	35	85	23	125	1.2	6	1500	1	316	285	126
TRJC685*035#RJ	C	6.8	35	85	23	125	1.8	6	1070	1	321	289	128
TRJC685*035#0600	C	6.8	35	85	23	125	1.8	6	600	1	428	385	171
TRJD685*035#RJ	D	6.8	35	85	23	125	1.8	6	1300	1	340	306	136
TRJC106*035#RJ	C	10	35	85	23	125	2.6	6	800	1	371	334	148
TRJC106*035#0600	C	10	35	85	23	125	2.6	6	600	1	428	385	171
TRJD106*035#RJ	D	10	35	85	23	125	2.6	6	800	1	433	390	173
TRJD106*035#0250	D	10	35	85	23	125	2.6	6	250	1	775	697	310
TRJD106*035#0400	D	10	35	85	23	125	2.6	6	400	1	612	551	245
TRJD156*035#RJ	D	15	35	85	23	125	3.9	6	720	1	456	411	183
TRJD156*035#0225	D	15	35	85	23	125	3.9	6	225	1	816	735	327
TRJD226*035#RJ	D	22	35	85	23	125	5.8	6	650	1	480	432	192
TRJD226*035#0200	D	22	35	85	23	125	5.8	6	200	1	866	779	346
TRJD226*035#0400	D	22	35	85	23	125	5.8	6	400	1	612	551	245
TRJE336*035#RJ	E	33	35	85	23	125	8.7	6	590	1 ¹⁾	529	476	212
TRJE336*035#0150	E	33	35	85	23	125	8.7	6	150	1 ¹⁾	1049	944	420
TRJE336*035#0250	E	33	35	85	23	125	8.7	6	250	1 ¹⁾	812	731	325
TRJU476*035RRJV	U	47	35	85	23	125	12.3	10	400	3	642	578	257
TRJU476*035R0200V	U	47	35	85	23	125	12.3	10	200	3	908	8.17	363
50 Volt @ 85°C													
TRJA224*050#RJ	A	0.22	50	85	33	125	0.3	4	7500	1	100	90	40
TRJA224*050#7000	A	0.22	50	85	33	125	0.3	4	7000	1	104	93	41
TRJA334*050#RJ	A	0.33	50	85	33	125	0.3	4	7000	1	104	93	41
TRJB474*050#RJ	B	0.47	50	85	33	125	0.3	4	5000	1	130	117	52
TRJB684*050#RJ	B	0.68	50	85	33	125	0.3	4	4000	1	146	131	58
TRJB684*050#2000	B	0.68	50	85	33	125	0.3	4	2000	1	206	186	82
TRJB105*050#RJ	B	1	50	85	33	125	0.4	4	3400	1	158	142	63
TRJB105*050#2000	B	1	50	85	33	125	0.4	4	2000	1	206	186	82
TRJC105*050#RJ	C	1	50	85	33	125	0.4	4	3000	1	191	172	77
TRJC155*050#RJ	C	1.5	50	85	33	125	0.6	6	2500	1	210	189	84
TRJC155*050#1500	C	1.5	50	85	33	125	0.6	6	1500	1	271	244	108
TRJC225*050#RJ	C	2.2	50	85	33	125	0.8	6	1700	1	254	229	102
TRJC225*050#1000	C	2.2	50	85	33	125	0.8	6	1000	1	332	298	133
TRJD225*050#RJ	D	2.2	50	85	33	125	0.8	4.5	2000	1	274	246	110

RATINGS & PART NUMBER REFERENCE

AVX Part No.	Case Size	Capacitance (μF)	Rated Voltage (V)	Rated Temperature (°C)	Category Voltage (V)	Category Temperature (°C)	DCL Max. (μA)	DF Max. (%)	ESR Max. @ 100kHz (mΩ)	MSL	100kHz RMS Current (mA)		
											25°C	85°C	125°C
TRJD225*050#1200	D	2.2	50	85	33	125	0.8	4.5	1200	1	354	318	141
TRJC335*050#RJ	C	3.3	50	85	33	125	1.2	6	1400	1	280	252	112
TRJC335*050#1000	C	3.3	50	85	33	125	1.2	6	1000	1	332	298	133
TRJD335*050#RJ	D	3.3	50	85	33	125	1.2	4.5	1100	1	369	332	148
TRJD335*050#0800	D	3.3	50	85	33	125	1.2	4.5	800	1	433	390	173
TRJD475*050#RJ	D	4.7	50	85	33	125	1.8	4.5	900	1	408	367	163
TRJD475*050#0600	D	4.7	50	85	33	125	1.8	4.5	600	1	500	450	200
TRJD685*050#RJ	D	6.8	50	85	33	125	2.6	4.5	700	1	463	417	185
TRJE106*050#RJ	E	10	50	85	33	125	3.8	4.5	700	1 ¹⁾	486	437	194
TRJE106*050#0300	E	10	50	85	33	125	3.8	4.5	300	1 ¹⁾	742	667	297
TRJE106*050#0400	E	10	50	85	33	125	3.8	4.5	400	1 ¹⁾	642	578	257
TRJU156*050RRJV	U	15	50	85	33	125	5.6	30	500	3	574	517	230
TRJU226*050RRJV	U	22	50	85	33	125	8.2	30	500	3	574	517	230

¹⁾ Dry pack option (see How to order) is recommended for reduction of stress during soldering. Dry pack parts should be treated as MSL 3.

Moisture Sensitivity Level (MSL) is defined according to J-STD-020.

All technical data relates to an ambient temperature of +25°C. Capacitance and DF are measured at 120Hz, 0.5V RMS with a maximum DC bias of 2.2 volts. DCL is measured at rated voltage after 5 minutes.

The EIA & CECC standards for low ESR Solid Tantalum Capacitors allow an ESR movement to 1.25 times catalogue limit post mounting.

For typical weight and composition see page 222.

NOTE: AVX reserves the right to supply a higher voltage rating or tighter tolerance part in the same case size, to the same reliability standards.

QUALIFICATION TABLE

TEST	TRJ professional series (Temperature range -55°C to +125°C)										
	Condition			Characteristics							
Endurance	Determine after application of rated voltage for 2000 +48/-0 hours at 85±2°C and then leaving 1-2 hours at room temperature. Also determine of 125°C temperature, category voltage for 2000 +48/-0 hours and then leaving 1-2 hours at room temperature. Power supply impedance to be ≤0.1Ω/V.			Visual examination	no visible damage						
				DCL	1.25 x initial limit						
				ΔC/C	within ±10% of initial value						
				DF	initial limit						
				ESR	1.25 x initial limit						
Storage Life	125°C, 0V, 2000h			Visual examination	no visible damage						
				DCL	1.25 x initial limit						
				ΔC/C	within ±10% of initial value						
				DF	initial limit						
				ESR	1.25 x initial limit						
Humidity	Determine after storage without applied voltage at 65±2°C and 95±2% relative humidity for 500 hours and then recovery 1-2 hours at room temperature.			Visual examination	no visible damage						
				DCL	1.5 x initial limit						
				ΔC/C	within ±10% of initial value						
				DF	1.2 x initial limit						
				ESR	1.25 x initial limit						
Biased Humidity	Determine after leaving for 1000 hours at 85±2°C, 85% relative humidity and rated voltage and then recovery 1-2 hours at room temperature.			Visual examination	no visible damage						
				DCL	2 x initial limit						
				ΔC/C	within ±10% of initial value						
				DF	1.2 x initial limit						
				ESR	1.25 x initial limit						
Temperature Stability	Step	Temperature°C	Duration(min)		+20°C	-55°C	+20°C	+85°C	+125°C	+20°C	
	1	+20±2	15	DCL	IL*	n/a	IL*	10 x IL*	12.5 x IL*	IL*	
	2	-55+0/-3	15	ΔC/C	n/a	+0/-10%	±5%	+10/-0%	+12/-0%	±5%	
	3	+20±2	15	DF	IL*	1.5 x IL*	IL*	1.5 x IL*	2 x IL*	IL*	
	4	+85+3/-0	15	ESR	1.25 x IL*	2.5 x IL*	1.25 x IL*	1.25 x IL*	1.25 x IL*	1.25 x IL*	
	5	+125+3/-0	15								
	6	+20±2	15								
Surge Voltage	Test temperature: 125°C+3/0°C Test voltage: Category voltage at 125°C Surge voltage: 1.3 x category voltage at 125°C Series protection resistance 1000±100Ω Discharge resistance: 1000Ω Number of cycles: 1000x Cycle duration: 6 min; 30 sec charge, 5 min 30 sec discharge			Visual examination	no visible damage						
				DCL	initial limit						
				ΔC/C	within ±5% of initial value						
				DF	initial limit						
				ESR	1.25 x initial limit						
Mechanical Shock	MIL-STD-202, Method 213, Condition F			Visual examination	no visible damage						
				DCL	initial limit						
				ΔC/C	within ±5% of initial value						
				DF	initial limit						
				ESR	1.25 x initial limit						
Vibration	MIL-STD-202, Method 204, Condition D			Visual examination	no visible damage						
				DCL	initial limit						
				ΔC/C	within ±5% of initial value						
				DF	initial limit						
				ESR	1.25 x initial limit						

*Initial Limit

F97 Series



Resin-Molded Chip, Improved Reliability J-Lead



FEATURES

- Compliant to the RoHS2 directive 2011/65/EU
- Compliant to AEC-Q200
- Improved reliability - FR=0.5%/1000hrs (twice better than standard)
- SMD J-lead



APPLICATIONS

- Automotive electronics (Engine ECU)
- Industrial equipment

CASE DIMENSIONS: millimeters (inches)

Code	EIA Code	EIA Metric	L	W ₁	W ₂	H	S
A	1206	3216-18	3.20 ± 0.20 (0.126 ± 0.008)	1.60 ± 0.20 (0.063 ± 0.008)	1.20 ± 0.10 (0.047 ± 0.004)	1.60 ± 0.20 (0.063 ± 0.008)	0.80 ± 0.20 (0.031 ± 0.008)
B	1210	3528-21	3.50 ± 0.20 (0.126 ± 0.008)	2.80 ± 0.20 (0.110 ± 0.008)	2.20 ± 0.10 (0.087 ± 0.004)	1.90 ± 0.20 (0.075 ± 0.008)	0.80 ± 0.20 (0.031 ± 0.008)
C	2312	6032-27	6.00 ± 0.20 (0.236 ± 0.008)	3.20 ± 0.20 (0.126 ± 0.008)	2.20 ± 0.10 (0.087 ± 0.004)	2.50 ± 0.20 (0.098 ± 0.008)	1.30 ± 0.20 (0.051 ± 0.008)
N	2917	7343-30	7.30 ± 0.20 (0.287 ± 0.008)	4.30 ± 0.20 (0.169 ± 0.008)	2.40 ± 0.10 (0.094 ± 0.004)	2.80 ± 0.20 (0.110 ± 0.008)	1.30 ± 0.20 (0.051 ± 0.008)

A, B CASE

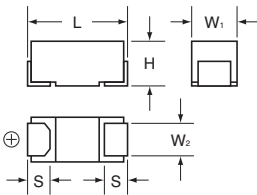

C, N CASE

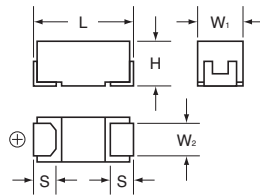

MARKING

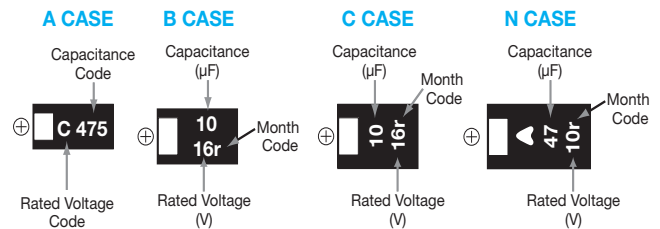

HOW TO ORDER

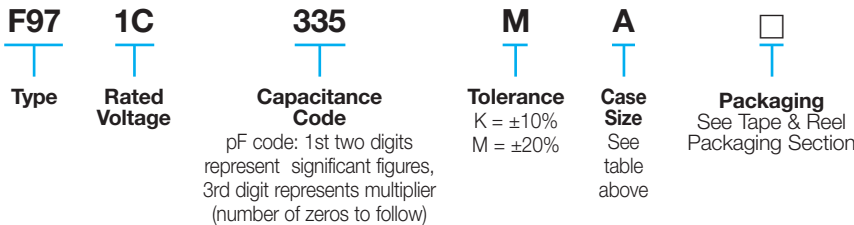

TECHNICAL SPECIFICATIONS

Category Temperature Range:	-55 to +125°C
Rated Temperature:	+85°C
Capacitance Tolerance:	±20%, ±10% at 120Hz
Dissipation Factor:	Refer to next page
ESR 100kHz:	Refer to next page
Leakage Current:	After 1 minute's application of rated voltage, leakage current at 20°C is not more than 0.01CV or 0.5µA, whichever is greater. After 1 minute's application of rated voltage, leakage current at 85°C is not more than 0.1CV or 5µA, whichever is greater. After 1 minute's application of derated voltage, leakage current at 125°C is not more than 0.125CV or 6.3µA, whichever is greater.
Capacitance Change By Temperature	+15% Max. at +125°C +10% Max. at +85°C -10% Max. at -55°C

F97 Series



Resin-Molded Chip, Improved Reliability J-Lead

CAPACITANCE AND RATED VOLTAGE RANGE (LETTER DENOTES CASE SIZE)

Capacitance		Rated Voltage					
μF	Code	6.3V (0J)	10V (1A)	16V (1C)	20V (1D)	25V (1E)	35V (1V)
0.33	334						A
0.47	474						A
0.68	684				A	A	A
1.0	105			A	A	A	A*/B
1.5	155			A	A		A*/B
2.2	225		A	A	A	A*/B	B
3.3	335	A	A	A	B	B	B*/C
4.7	475	A	A/B	A/B	A/B	B*/C	C
6.8	685	A/B	B	B	B*/C	C	C*/N
10	106		A/B	A/B/C	B*/C	C/N	N
15	156	B	B	A/B*/C	N	C*/N	
22	226	A/B	A/B	B/C/N	C/N	N	
33	336	A/C	B/C/N	B/C/N		N*	
47	476	B/C	B/C/N	C/N			
68	686	N	N				
100	107	N	C/N*				
150	157	C					

Available Ratings

*Codes under development – subject to change

Please contact to your local AVX sales office when these series are being designed in your application.

F97 Series



Resin-Molded Chip, Improved Reliability J-Lead

RATINGS & PART NUMBER REFERENCE

AVX Part No.	Case Size	Capacitance (μF)	Rated Voltage (V)	DCL (μA)	DF @ 120Hz (%)	ESR @ 100kHz (Ω)	*1 ΔC/C (%)
6.3 Volt							
F970J335MAA	A	3.3	6.3	0.5	4	4.5	*
F970J475MAA	A	4.7	6.3	0.5	6	4.0	*
F970J685MAA	A	6.8	6.3	0.5	6	3.5	*
F970J685MBA	B	6.8	6.3	0.5	6	2.5	*
F970J156MBA	B	15	6.3	0.9	6	2.0	*
F970J226MAA	A	22	6.3	1.4	12	2.5	*
F970J226MBA	B	22	6.3	1.4	8	1.9	*
F970J336MAA	A	33	6.3	2.1	12	2.5	*
F970J336MCC	C	33	6.3	2.1	6	1.1	*
F970J476MBA	B	47	6.3	3.0	8	1.0	*
F970J476MCC	C	47	6.3	3.0	6	0.9	*
F970J686MNC	N	68	6.3	4.3	6	0.6	*
F970J107MNC	N	100	6.3	6.3	8	0.6	*
F970J157MCC	C	150	6.3	9.5	12	0.7	*
10 Volt							
F971A225MAA	A	2.2	10	0.5	4	5.0	*
F971A335MAA	A	3.3	10	0.5	4	4.5	*
F971A475MAA	A	4.7	10	0.5	6	4.0	*
F971A475MBA	B	4.7	10	0.5	6	2.8	*
F971A685MBA	B	6.8	10	0.7	6	2.5	*
F971A106MAA	A	10	10	1.0	6	3.0	*
F971A106MBA	B	10	10	1.0	6	2.0	*
F971A156MBA	B	15	10	1.5	6	2.0	*
F971A226MAA	A	22	10	2.2	15	3.0	*
F971A226MBA	B	22	10	2.2	8	1.9	*
F971A336MBA	B	33	10	3.3	8	1.9	*
F971A336MCC	C	33	10	3.3	6	1.1	*
F971A336MNC	N	33	10	3.3	6	0.7	*
F971A476MBA	B	47	10	4.7	10	1.0	*
F971A476MCC	C	47	10	4.7	8	0.9	*
F971A476MNC	N	47	10	4.7	6	0.7	*
F971A686MNC	N	68	10	6.8	6	0.6	*
F971A107MCC	C	100	10	10.0	10	0.7	*
16 Volt							
F971C105MAA	A	1	16	0.5	4	7.5	*
F971C155MAA	A	1.5	16	0.5	4	6.3	*
F971C225MAA	A	2.2	16	0.5	4	5.0	*
F971C335MAA	A	3.3	16	0.5	4	4.5	*
F971C475MAA	A	4.7	16	0.8	8	4.0	*
F971C475MBA	B	4.7	16	0.8	6	2.8	*
F971C685MBA	B	6.8	16	1.1	6	2.5	*
F971C106MAA	A	10	16	1.6	8	3.5	*
F971C106MBA	B	10	16	1.6	6	2.1	*
F971C106MCC	C	10	16	1.6	6	1.5	*

AVX Part No.	Case Size	Capacitance (μF)	Rated Voltage (V)	DCL (μA)	DF @ 120Hz (%)	ESR @ 100kHz (Ω)	*1 ΔC/C (%)
F971C156MAA	A	15	16	2.4	12	3.5	±10
F971C156MCC	C	15	16	2.4	6	1.2	*
F971C226MBA	B	22	16	3.5	8	1.9	*
F971C226MCC	C	22	16	3.5	8	1.1	*
F971C226MNC	N	22	16	3.5	6	0.7	*
F971C336MBA	B	33	16	5.3	10	2.1	*
F971C336MCC	C	33	16	5.3	8	1.1	*
F971C336MNC	N	33	16	5.3	6	0.7	*
F971C476MCC	C	47	16	7.5	10	1.1	*
F971C476MNC	N	47	16	7.5	8	0.7	*
20 Volt							
F971D684MAA	A	0.68	20	0.5	4	7.6	*
F971D105MAA	A	1	20	0.5	4	7.5	*
F971D155MAA	A	1.5	20	0.5	4	6.7	*
F971D225MAA	A	2.2	20	0.5	6	6.3	*
F971D335MBA	B	3.3	20	0.7	4	3.1	*
F971D475MAA	A	4.7	20	0.9	8	4.0	*
F971D475MBA	B	4.7	20	0.9	6	2.8	*
F971D685MCC	C	6.8	20	1.4	6	1.8	*
F971D106MCC	C	10	20	2.0	6	1.5	*
F971D156MNC	N	15	20	3.0	6	0.7	*
F971D226MCC	C	22	20	4.4	8	1.1	*
F971D226MNC	N	22	20	4.4	6	0.7	*
25 Volt							
F971E684MAA	A	0.68	25	0.5	4	7.6	*
F971E105MAA	A	1	25	0.5	4	7.5	*
F971E225MBA	B	2.2	25	0.6	4	3.8	*
F971E335MBA	B	3.3	25	0.8	4	3.5	*
F971E475MCC	C	4.7	25	1.2	6	1.8	*
F971E685MCC	C	6.8	25	1.7	6	1.8	*
F971E106MCC	C	10	25	2.5	6	1.6	*
F971E106MNC	N	10	25	2.5	6	1.0	*
F971E156MNC	N	15	25	3.8	6	0.7	*
F971E226MNC	N	22	25	5.5	6	0.7	*
35 Volt							
F971V334MAA	A	0.33	35	0.5	4	12.0	*
F971V474MAA	A	0.47	35	0.5	4	10.0	*
F971V684MAA	A	0.68	35	0.5	4	7.6	*
F971V105MBA	B	1	35	0.5	4	4.0	*
F971V155MBA	B	1.5	35	0.5	4	4.0	*
F971V225MBA	B	2.2	35	0.8	4	3.8	*
F971V335MCC	C	3.3	35	1.2	4	2.0	*
F971V475MCC	C	4.7	35	1.6	6	1.8	*
F971V685MNC	N	6.8	35	2.4	6	1.0	*
F971V106MNC	N	10	35	3.5	6	1.0	*

* In case of capacitance tolerance ± 10% type, "K" will be put at 9th digit of type numbering system

1: ΔC/C Marked ""

Item	All Case (%)
Damp Heat	±10
Temperature cycles	±5
Resistance soldering heat	±5
Surge	±5
Endurance	±10
Load Humidity	±10

QUALIFICATION TABLE

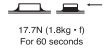
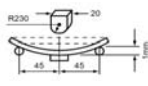
TEST	F97 series (Temperature range -55°C to +125°C)	
	Condition	
Damp Heat (Steady State)	At 85°C, 85% R.H., 1000 hours (No voltage applied) Capacitance Change Refer to page 92 (*1) Dissipation Factor Initial specified value or less Leakage Current 125% or less than the initial specified value	
Load Humidity	After 1000 hour's application of rated voltage in series with a 33Ω resistor at 85°C, 85% R.H., capacitors meet the characteristics requirements table below. Capacitance Change Refer to page 92 (*1) Dissipation Factor 120% or less than the initial specified value Leakage Current 200% of less than the initial specified value	
Temperature Cycles	At -55°C / +125°C, 30 minutes each, 1000 cycles Capacitance Change Refer to page 92 (*1) Dissipation Factor Initial specified value or less Leakage Current Initial specified value or less	
Resistance to Soldering Heat	10 seconds reflow at 260°C, 5 seconds immersion at 260°C. Capacitance Change Refer to page 92 (*1) Dissipation Factor Initial specified value or less Leakage Current Initial specified value or less	
Solderability	After immersing capacitors completely into a solder pot at 245°C for 2 to 3 seconds, more than 3/4 of their electrode area shall remain covered with new solder.	
Surge	After application of surge voltage in series with a 33Ω resistor at the rate of 30 seconds ON, 30 seconds OFF, for 1000 successive test cycles at 85°C, capacitors shall meet the characteristic requirements in the table above. Capacitance Change Refer to page 92 (*1) Dissipation Factor Initial specified value or less Leakage Current Initial specified value or less	
Endurance	After 2000 hours' application of rated voltage in series with a 3Ω resistor at 85°C, or derated voltage in series with a 3Ω resistor at 125°C, capacitors shall meet the characteristic requirements in the table above. Capacitance Change Refer to page 92 (*1) Dissipation Factor Initial specified value or less Leakage Current Initial specified value or less	
Shear Test	After applying the pressure load of 17.7N for 60 seconds horizontally to the center of capacitor side body which has no electrode and has been soldered beforehand on a substrate, there shall be found neither exfoliation nor its sign at the terminal electrode..	
Terminal Strength	Keeping a capacitor surface-mounted on a substrate upside down and supporting the substrate at both of the opposite bottom points 45mm apart from the center of capacitor, the pressure strength is applied with a specified jig at the center of the substrate so that substrate may bend by 1mm as illustrated. Then, there shall be found no remarkable abnormality on the capacitor terminals.	
Failure Rate	0.5% per 1000 hours at 85°C, V _R with 0.1Ω/V series impedance, 60% confidence level.	

TRM Professional Multianode



Tantalum Ultra Low ESR Capacitor



FEATURES

- Improved reliability – 0.5%/1khrs (twice better than standard)
- DCL reduced by 25% to 0.0075 CV
- Robust against higher thermo-mechanical stresses during assembly process
- Multi-anode construction
- Super low ESR
- CV range 4.7-1500µF / 2.5-50V
- “Mirror” construction used with D case capacitors reduces ESL to half
- Automotive, medical, aerospace, military and other hi-end application



SnPb termination option is not
RoHS compliant.

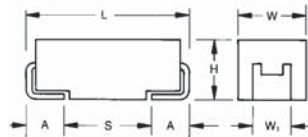

APPLICATIONS

- Automotive, Avionics and Industrial high power DC/DC convertors

MULTIANODE CONSTRUCTION

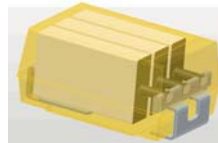

MULTIANODE TRM D LOW SELF INDUCTANCE CONSTRUCTION “MIRROR” DESIGN

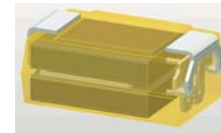

MARKING

D, E CASE

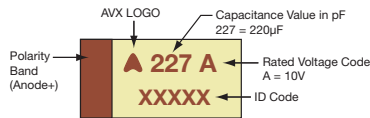

CASE DIMENSIONS: millimeters (inches)

Code	EIA Code	EIA Metric	L±0.20 (0.008)	W+0.20 (0.008) -0.10 (0.004)	H+0.20 (0.008) -0.10 (0.004)	W ₁ ±0.20 (0.008)	A+0.30 (0.012) -0.20 (0.008)	S Min.
D	2917	7343-31	7.30 (0.287)	4.30 (0.169)	2.90 (0.114)	2.40 (0.094)	1.30 (0.051)	4.40 (0.173)
E	2917	7343-43	7.30 (0.287)	4.30 (0.169)	4.10 (0.162)	2.40 (0.094)	1.30 (0.051)	4.40 (0.173)

W₁ dimension applies to the termination width for A dimensional area only.

HOW TO ORDER

TRM

E

108

004

R

0023

Type

Case Size
See table above

Capacitance Code
pF code: 1st two digits represent significant figures, 3rd digit represents multiplier (number of zeros to follow)

Tolerance
K=±10%
M=±20%

Rated DC Voltage
002 = 2.5Vdc
004 = 4Vdc
006 = 6.3Vdc
010 = 10Vdc
012 = 12Vdc
016 = 16Vdc
020 = 20Vdc
025 = 25Vdc
035 = 35Vdc
050 = 50Vdc

Packaging
R = Pure Tin 7" Reel
S = Pure Tin 13" Reel
H = Tin Lead 7" Reel (Contact Manufacturer)
K = Tin Lead 13" Reel (Contact Manufacturer)
H, K = Non RoHS

ESR in mΩ

TECHNICAL SPECIFICATIONS

Technical Data:

All technical data relate to an ambient temperature of +25°C

Capacitance Range:

4.7 µF to 1500 µF

Capacitance Tolerance:

±10%; ±20%

Rated Voltage (V _R)	≤ +85°C:	2.5	4	6.3	10	12	16	20	25	35	50
Category Voltage (V _C)	≤ +125°C:	1.7	2.7	4	7	8	10	13	17	23	33
Surge Voltage (V _S)	≤ +85°C:	3.3	5.2	8	13	16	20	26	32	46	65
Surge Voltage (V _S)	≤ +125°C:	2.2	3.4	5	8	10	13	16	20	28	40

Temperature Range:

-55°C to +125°C

Reliability:

0.5% per 1000 hours at 85°C, V_R with 0.1Ω/V series impedance, 60% confidence level

Meets requirements of AEC-Q200

TRM Professional Multianode



Tantalum Ultra Low ESR Capacitor

CAPACITANCE AND RATED VOLTAGE RANGE (LETTER DENOTES CASE SIZE)

Capacitance		Rated Voltage DC (V_R) to 85°C									
µF	Code	2.5V (e)	4V (G)	6.3V (J)	10V (A)	12V (B)	16V (C)	20V (D)	25V (E)	35V (V)	50V (T)
4.7	475										D(200)
6.8	685										
10	106									D(120)	E(150)*
15	156										
22	226									D(70)/E(60,100)	
33	336								D(65)	E(50,65)	
47	476						D(100)	D(55)	E(65)		
68	686										
100	107						D(55)*	E(35,45)			
150	157				D(45)		E(30,40)				
220	227				D(35)	E(35)					
330	337		D(35)	D(35)	E(35)						
470	477		D(35)	E(30)							
680	687		E(23)								
1000	108	D(25)	E(23)								
1500	158	E(18)									
2200	228										

Released ratings, (ESR ratings in mOhms in parenthesis)

Engineering samples - please contact AVX

*Ratings under development - subject to change

Note: Voltage ratings are minimum values. AVX reserves the right to supply higher ratings in the same case size, to the same reliability standards.

TRM Professional Multianode



Tantalum Ultra Low ESR Capacitor

RATINGS & PART NUMBER REFERENCE

AVX Part No.	Case Size	Capacitance (µF)	Rated Voltage (V)	Rated Temperature (°C)	Category Voltage (V)	Category Temperature (°C)	DCL Max. (µA)	DF Max. (%)	ESR Max. @ 100kHz (mΩ)	MSL	100kHz RMS Current (A)		
											25°C	85°C	125°C
2.5 Volt @ 85°C													
TRMD108*002#0025	D	1000	2.5	85	1.7	125	18.8	8	25	3	3.194	2.874	1.277
TRME158*002#0018	E	1500	2.5	85	1.7	125	28.1	6	18	3	3.873	3.486	1.549
4 Volt @ 85°C													
TRMD337*004#0035	D	330	4	85	2.7	125	9.9	8	35	3	2.699	2.429	1.080
TRMD477*004#0035	D	470	4	85	2.7	125	14.1	8	35	3	2.699	2.429	1.080
TRME687*004#0023	E	680	4	85	2.7	125	20.4	6	23	3	3.426	3.084	1.370
TRME108*004#0023	E	1000	4	85	2.7	125	30	6	23	3	3.426	3.084	1.370
6.3 Volt @ 85°C													
TRMD337*006#0035	D	330	6.3	85	4	125	14.9	8	35	3	2.699	2.429	1.080
TRME477*006#0030	E	470	6.3	85	4	125	21.2	6	30	3	3.000	2.700	1.200
10 Volt @ 85°C													
TRMD157*010#0045	D	150	10	85	7	125	11.3	8	45	3	2.380	2.142	0.952
TRMD227*010#0035	D	220	10	85	7	125	16.5	8	35	3	2.699	2.429	1.080
TRME337*010#0035	E	330	10	85	7	125	24.8	6	35	3	2.777	2.500	1.111
12 Volt @ 85°C													
TRME227*012#0035	E	220	12	85	8.4	125	19.8	6	35	3	2.777	2.500	1.111
16 Volt @ 85°C													
TRMD476*016#0100	D	47	16	85	10	125	5.6	8	100	3	1.597	1.437	0.639
TRME157*016#0030	E	150	16	85	10	125	18	6	30	3	3.000	2.700	1.200
TRME157*016#0040	E	150	16	85	10	125	18	6	40	3	2.598	2.338	1.039
20 Volt @ 85°C													
TRMD476*020#0055	D	47	20	85	13	125	7.1	8	55	3	2.153	1.938	0.861
TRME107*020#0035	E	100	20	85	13	125	15	6	35	3	2.777	2.500	1.111
TRME107*020#0045	E	100	20	85	13	125	15	6	45	3	2.449	2.205	0.980
25 Volt @ 85°C													
TRMD336*025#0065	D	33	25	85	17	125	6.2	8	65	3	1.981	1.783	0.792
TRME476*025#0065	E	47	25	85	17	125	8.8	6	65	3	2.038	1.834	0.815
35 Volt @ 85°C													
TRMD106*035#0120	D	10	35	85	23	125	2.6	8	120	3	1.458	1.312	0.583
TRMD226*035#0070	D	22	35	85	23	125	5.8	8	70	3	1.909	1.718	0.763
TRME226*035#0060	E	22	35	85	23	125	5.8	6	60	3	2.121	1.909	0.849
TRME226*035#0100	E	22	35	85	23	125	5.8	6	100	3	1.643	1.479	0.657
TRME336*035#0050	E	33	35	85	23	125	8.7	6	50	3	2.324	2.091	0.930
TRME336*035#0065	E	33	35	85	23	125	8.7	6	65	3	2.038	1.834	0.815
50 Volt @ 85°C													
TRMD475*050#0200	D	4.7	50	85	33	125	1.8	8	200	3	1.129	1.016	0.452

Moisture Sensitivity Level (MSL) is defined according to J-STD-020.

All technical data relates to an ambient temperature of +25°C. Capacitance and DF are measured at 120Hz, 0.5V RMS with a maximum DC bias of 2.2 volts. DCL is measured at rated voltage after 5 minutes.

The EIA & CECC standards for low ESR Solid Tantalum Capacitors allow an ESR movement to 1.25 times catalogue limit post mounting.

For typical weight and composition see page 222.

NOTE: AVX reserves the right to supply a higher voltage rating or tighter tolerance part in the same case size, to the same reliability standards.

TRM Professional Multianode



Tantalum Ultra Low ESR Capacitor

QUALIFICATION TABLE

TEST	TRM professional multianode series (Temperature range -55°C to +125°C)										
	Condition			Characteristics							
Endurance	Determine after application of rated voltage for 2000 +48/-0 hours at 85±2°C and then leaving 1-2 hours at room temperature. Also determine of 125°C temperature, category voltage for 2000 +48/-0 hours and then leaving 1-2 hours at room temperature. Power supply impedance to be ≤0.1Ω/V.			Visual examination	no visible damage						
				DCL	initial limit						
				ΔC/C	within ±10% of initial value						
				DF	initial limit						
				ESR	1.25 x initial limit						
Storage Life	125°C, 0V, 2000h			Visual examination	no visible damage						
				DCL	1.25 x initial limit						
				ΔC/C	within ±10% of initial value						
				DF	initial limit						
				ESR	1.25 x initial limit						
Humidity	Determine after storage without applied voltage at 65±2°C and 95±2% relative humidity for 500 hours and then recovery 1-2 hours at room temperature.			Visual examination	no visible damage						
				DCL	1.5 x initial limit						
				ΔC/C	within ±10% of initial value						
				DF	1.2 x initial limit						
				ESR	1.25 x initial limit						
Biased Humidity	Determine after leaving for 1000 hours at 85±2°C, 85% relative humidity and rated voltage and then recovery 1-2 hours at room temperature.			Visual examination	no visible damage						
				DCL	2 x initial limit						
				ΔC/C	within ±10% of initial value						
				DF	1.2 x initial limit						
				ESR	1.25 x initial limit						
Temperature Stability	Step	Temperature°C	Duration(min)		+20°C	-55°C	+20°C	+85°C	+125°C	+20°C	
	1	+20±2	15	DCL	IL*	n/a	IL*	10 x IL*	12.5 x IL*	IL*	
	2	-55+0/-3	15	ΔC/C	n/a	+0/-10%	±5%	+10/-0%	+12/-0%	±5%	
	3	+20±2	15	DF	IL*	1.5 x IL*	IL*	1.5 x IL*	2 x IL*	IL*	
	4	+85+3/-0	15	ESR	1.25 x IL*	2.5 x IL*	1.25 x IL*	1.25 x IL*	1.25 x IL*	1.25 x IL*	
	5	+125+3/-0	15								
	6	+20±2	15								
Surge Voltage	Test temperature: 125°C+3/0°C Test voltage: Category voltage at 125°C Surge voltage: 1.3 x category voltage at 125°C Series protection resistance 1000±100Ω Discharge resistance: 1000Ω Number of cycles: 1000x Cycle duration: 6 min; 30 sec charge, 5 min 30 sec discharge			Visual examination	no visible damage						
				DCL	initial limit						
				ΔC/C	within ±5% of initial value						
				DF	initial limit						
				ESR	1.25 x initial limit						
Mechanical Shock	MIL-STD-202, Method 213, Condition F			Visual examination	no visible damage						
				DCL	initial limit						
				ΔC/C	within ±5% of initial value						
				DF	initial limit						
				ESR	1.25 x initial limit						
Vibration	MIL-STD-202, Method 204, Condition D			Visual examination	no visible damage						
				DCL	initial limit						
				ΔC/C	within ±5% of initial value						
				DF	initial limit						
				ESR	1.25 x initial limit						

*Initial Limit

TMJ Tantalum SMD S1gma™ Series Capacitors

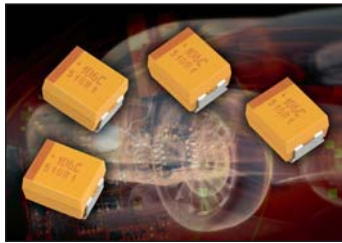

TMJ CONSTRUCTION

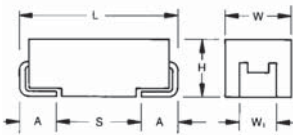

MARKING

A, B, C, D, E, U CASE

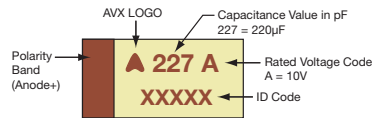

HOW TO ORDER

TMJ	D	227	K	006	#	C	^	A
Type	Case Size See table above	Capacitance Code pF code: 1st two digits represent significant figures, 3rd digit represents multiplier (number of zeros to follow)	Tolerance K = ±10%	Rated DC Voltage 006 = 6.3Vdc 010 = 10Vdc 016 = 16Vdc 020 = 20Vdc 025 = 25Vdc 035 = 35Vdc 050 = 50Vdc	Packaging R = Pure Tin 7" Reel H = Tin Lead 7" Reel (Contact Manufacturer) Non RoHS	ESR Range C = Standard L = Low ESR	Suffix QX = S1gma™ Prime QY = S1gma™ Premium xx = S1gma™ Pro Custom	DCL A = 0.001CV C = 0.005CV

TECHNICAL SPECIFICATIONS

Technical Data:	All technical data relate to an ambient temperature of +25°C								
Capacitance Range:	0.22 µF to 680 µF								
Capacitance Tolerance:	±10%								
Leakage Current DCL:	(A) 0.001CV, (C) 0.005CV								
Rated Voltage (V _R)	≤ +85°C:	6.3	10	16	20	25	35	50	
Category Voltage (V _C)	≤ +125°C:	4	7	10	13	17	23	33	
Surge Voltage (V _S)	≤ +85°C:	8	13	20	26	32	46	65	
Surge Voltage (V _S)	≤ +125°C:	5	8	13	16	20	28	40	
Temperature Range:	-55°C to +125°C								
Reliability:	0.5% per 1000 hours at 85°C, VR with 0.1Ω/V series impedance, 60% confidence level AEC-Q200 per request								

The AVX S1gma™ series is offering a next generation of statistical screening and process control enhancement of tantalum capacitors for professional applications with improved reliability and extremely low DCL needs.



FEATURES

- -55 to +125°C operation temperature
- Basic reliability better than 0.5%/1000 hours
- (2x improvement over commercial series)
- improved DCL limits 0.001CV* and 0.005CV

S1gma™ Prime – Utilises 3 S1gma™ electrical screening to remove possible maverick parts from the distribution.

S1gma™ Premium – S1gma™ Prime, with addition of capability statistical screening utilising the AVX patented Q-Process to effectively remove components that may experience excessive parametric shifts or instability in operational life.

S1gma™ Pro Custom – A custom option where specific parameter limits and screening methods can be agreed based on 3 S1gma™ and Q-Process statistical screening based on capability techniques.

*selected codes, 0.001CV limit is available with S1gma™ Premium and Pro Custom options only

APPLICATIONS

- Wireless battery operated sensors
- TPM
- Automotive
- Avionics
- Safety systems
- Energy harvesting

For additional information on Q-process please consult the AVX technical publication "Reaching the Highest Reliability for Tantalum Capacitors" (see the link: <http://www.avx.com/docs/techinfo/Qprocess.pdf>)

CASE DIMENSIONS: millimeters (inches)

Code	EIA Code	EIA Metric	L±0.20 (0.008)	W+0.20 (0.008) -0.10 (0.004)	H+0.20 (0.008) -0.10 (0.004)	W ₁ ±0.20 (0.008)	A+0.30 (0.012) -0.20 (0.008)	S Min.
A	1206	3216-18	3.20 (0.126)	1.60 (0.063)	1.60 (0.063)	1.20 (0.047)	0.80 (0.031)	1.10 (0.043)
B	1210	3528-21	3.50 (0.138)	2.80 (0.110)	1.90 (0.075)	2.20 (0.087)	0.80 (0.031)	1.40 (0.055)
C	2312	6032-28	6.00 (0.236)	3.20 (0.126)	2.60 (0.102)	2.20 (0.087)	1.30 (0.051)	2.90 (0.114)
D	2917	7343-31	7.30 (0.287)	4.30 (0.169)	2.90 (0.114)	2.40 (0.094)	1.30 (0.051)	4.40 (0.173)
E	2917	7343-43	7.30 (0.287)	4.30 (0.169)	4.10 (0.162)	2.40 (0.094)	1.30 (0.051)	4.40 (0.173)
U	2924	7361-43	7.30 (0.287)	6.10 (0.240)	4.10 (0.162)	3.10 (0.120)	1.30 (0.051)	4.40 (0.173)

W1 dimension applies to the termination width for A dimensional area only.

TMJ Tantalum SMD S1gma™ Series Capacitors



CAPACITANCE AND RATED VOLTAGE RANGE (LETTER DENOTES CASE SIZE)

Capacitance		Rated voltage (V_R) to 85°C (Voltage Code)						
μF	Code	6.3V (J)	10V (A)	16V (C)	20V (D)	25V (E)	35V (V)	50V (T)
0.22	224							A
0.33	334						A	A
0.47	474						A	B
0.68	684						A	B
1.0	105					A	B	C
1.5	155				A	A	B	C
2.2	225			A	A	B	B	C
3.3	335			A	A	B	B	C
4.7	475		A	A	B	B	C	D
6.8	685		A	B	B	C	C	D
10	106	A	A	B	C	C	C	E
15	156	A	B	B	C	C	D	U
22	226	B	B	C	C	D	D	
33	336	B	C	C	D	D	E	
47	476	C	C	D	D	D	U	
68	686	C	C	D	E	U		
100	107	C	D	E	E			
150	157	D	D	E	U			
220	227	D	E	U				
330	337	E	E					
470	477	E	U					
680	687	U						

Available Ratings

Note: Voltage ratings are minimum values. AVX reserves the right to supply higher ratings in the same case size, to the same reliability standards.

LEAKAGE CURRENT vs. RATED VOLTAGE

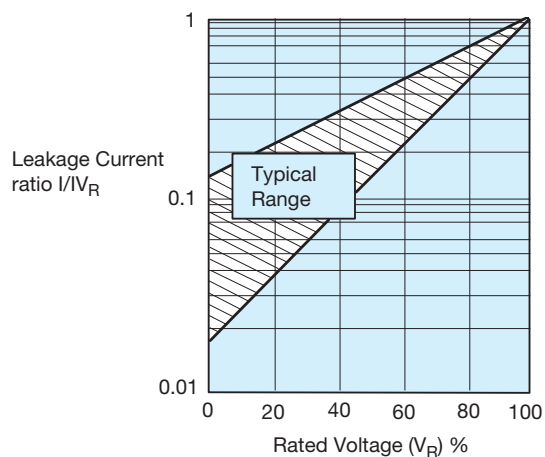

TMJ Tantalum SMD S1gma™ Series Capacitors



RATINGS & PART NUMBER REFERENCE

AVX Part No.	Case Size	Capacitance (µF)	Rated Voltage (V)	Rated Temperature (°C)	Category Voltage (V)	Category Temperature (°C)	DCL Max. (µA)	DF Max. (%)	ESR Max. @ 100kHz (mΩ)	MSL	100kHz RMS Current (mA)		
											25°C	85°C	125°C
6.3 Volt @ 85°C													
TMJA106K006#CQYA	A	10	6.3	85	4	125	0.1	6	1500	3	224	201	89
TMJA106K006#C^C	A	10	6.3	85	4	125	0.3	6	1500	3	224	201	89
TMJA156K006#CQYA	A	15	6.3	85	4	125	0.1	6	1500	3	224	201	89
TMJA156K006#C^C	A	15	6.3	85	4	125	0.45	6	1500	3	224	201	89
TMJB226K006#C^C	B	22	6.3	85	4	125	0.66	6	600	3	376	339	151
TMJB336K006#C^C	B	33	6.3	85	4	125	0.99	6	600	3	376	339	151
TMJC476K006#CQYA	C	47	6.3	85	4	125	0.28	6	300	3	606	545	242
TMJC476K006#C^C	C	47	6.3	85	4	125	1.41	6	300	3	606	545	242
TMJC686K006#CQYA	C	68	6.3	85	4	125	0.41	6	300	3	606	545	242
TMJC686K006#C^C	C	68	6.3	85	4	125	2.04	6	300	3	606	545	242
TMJC107K006#CQYA	C	100	6.3	85	4	125	0.60	6	300	3	606	545	242
TMJC107K006#C^C	C	100	6.3	85	4	125	3	6	300	3	606	545	242
TMJD157K006#CQYA	D	150	6.3	85	4	125	0.90	6	200	3	866	779	346
TMJD157K006#C^C	D	150	6.3	85	4	125	4.5	6	200	3	866	779	346
TMJD227K006#CQYA	D	220	6.3	85	4	125	1.32	8	200	3	866	779	346
TMJD227K006#C^C	D	220	6.3	85	4	125	6.6	8	200	3	866	779	346
TMJE337K006#C^C	E	330	6.3	85	4	125	9.9	8	200	3	908	817	363
TMJE477K006#CQYA	E	470	6.3	85	4	125	2.82	8	200	3	908	817	363
TMJE477K006#C^C	E	470	6.3	85	4	125	14.1	8	200	3	908	817	363
TMJU687K006#C^C	U	680	6.3	85	4	125	20.4	12	250	3	812	731	325
10 Volt @ 85°C													
TMJA475K010#CQXC	A	4.7	10	85	7	125	0.24	6	2000	3	194	174	77
TMJA685K010#CQYA	A	6.8	10	85	7	125	0.1	6	2000	3	194	174	77
TMJA685K010#C^C	A	6.8	10	85	7	125	0.34	6	2000	3	194	174	77
TMJA106K010#CQYA	A	10	10	85	7	125	0.10	6	2000	3	194	174	77
TMJA106K010#C^C	A	10	10	85	7	125	0.5	6	2000	3	194	174	77
TMJB156K010#C^C	B	15	10	85	7	125	0.75	6	700	3	348	314	139
TMJB226K010#C^C	B	22	10	85	7	125	1.1	6	700	3	348	314	139
TMJC336K010#C^C	C	33	10	85	7	125	1.65	6	300	3	606	545	242
TMJC476K010#C^C	C	47	10	85	7	125	2.35	6	300	3	606	545	242
TMJC686K010#C^C	C	68	10	85	7	125	3.4	6	300	3	606	545	242
TMJD107K010#C^C	D	100	10	85	7	125	5.00	6	150	3	1000	900	400
TMJD157K010#C^C	D	150	10	85	7	125	7.50	8	150	3	1000	900	400
TMJE227K010#C^C	E	220	10	85	7	125	11	8	150	3	1049	944	420
TMJE337K010#CQYA	E	330	10	85	7	125	3.3	8	150	3	1049	944	420
TMJE337K010#C^C	E	330	10	85	7	125	16.5	8	150	3	1049	944	420
TMJU477K010#C^C	U	470	10	85	7	125	23.5	12	200	3	908	817	363
16 Volt @ 85°C													
TMJA225K016#CQXC	A	2.2	16	85	10	125	0.18	6	3500	3	146	132	59
TMJA335K016#CQXC	A	3.3	16	85	10	125	0.26	6	3500	3	146	132	59
TMJA475K016#C^C	A	4.7	16	85	10	125	0.38	6	3500	3	146	132	59
TMJB685K016#C^C	B	6.8	16	85	10	125	0.54	6	1200	3	266	240	106
TMJB106K016#C^C	B	10	16	85	10	125	0.80	6	1200	3	266	240	106
TMJB156K016#C^C	B	15	16	85	10	125	1.20	6	1200	3	266	240	106
TMJC226K016#C^C	C	22	16	85	10	125	1.76	6	350	3	561	505	224
TMJC336K016#C^C	C	33	16	85	10	125	2.64	6	350	3	561	505	224
TMJD476K016#C^C	D	47	16	85	10	125	3.76	6	200	3	866	779	346
TMJD686K016#C^C	D	68	16	85	10	125	5.44	6	200	3	866	779	346
TMJE107K016#C^C	E	100	16	85	10	125	8.00	6	150	3	1049	944	420
TMJE157K016#C^C	E	150	16	85	10	125	12	6	150	3	1049	944	420
TMJU227K016#C^C	U	220	16	85	10	125	17.6	1	200	3	908	817	363
20 Volt @ 85°C													
TMJA155K020#CQXC	A	1.5	20	85	13	125	0.15	6	3000	3	158	142	63
TMJA225K020#CQXC	A	2.2	20	85	13	125	0.22	6	3000	3	158	142	63
TMJA335K020#C^C	A	3.3	20	85	13	125	0.33	6	3000	3	158	142	63
TMJB475K020#C^C	B	4.7	20	85	13	125	0.47	6	1000	3	292	262	117
TMJB685K020#C^C	B	6.8	20	85	13	125	0.68	6	1000	3	292	262	117
TMJC106K020#C^C	C	10	20	85	13	125	1	6	500	3	469	422	188
TMJC156K020#C^C	C	15	20	85	13	125	1.5	6	500	3	469	422	188
TMJC226K020#C^C	C	22	20	85	13	125	2.2	6	500	3	469	422	188
TMJD336K020#C^C	D	33	20	85	13	125	3.3	6	250	3	775	697	310
TMJD476K020#C^C	D	47	20	85	13	125	4.70	6	250	3	775	697	310
TMJE686K020#C^C	E	68	20	85	13	125	6.8	6	200	3	908	817	363
TMJE107K020#C^C	E	100	20	85	13	125	10	6	200	3	908	817	363
TMJU157K020#CQXC	U	150	20	85	13	125	15	12	250	3	812	731	325
25 Volt @ 85°C													
TMJA105K025#CQXC	A	1	25	85	17	125	0.13	4	3000	3	158	142	63
TMJA155K025#CQXC	A	1.5	25	85	17	125	0.19	6	3000	3	158	142	63
TMJB225K025#C^C	B	2.2	25	85	17	125	0.28	6	2000	3	206	186	82
TMJB335K025#C^C	B	3.3	25	85	17	125	0.41	6	2000	3	206	186	82

TMJ Tantalum SMD S1gma™ Series Capacitors



RATINGS & PART NUMBER REFERENCE

AVX Part No.	Case Size	Capacitance (µF)	Rated Voltage (V)	Rated Temperature (°C)	Category Voltage (V)	Category Temperature (°C)	DCL Max. (µA)	DF Max. (%)	ESR Max. @ 100kHz (mΩ)	MSL	100kHz RMS Current (mA)		
											25°C	85°C	125°C
TMJB475K025#C^C	B	4.7	25	85	17	125	0.59	6	2000	3	206	186	82
TMJC685K025#C^C	C	6.8	25	85	17	125	0.85	6	600	3	428	385	171
TMJC106K025#C^C	C	10	25	85	17	125	1.25	6	600	3	428	385	171
TMJC156K025#C^C	C	15	25	85	17	125	1.88	6	600	3	428	385	171
TMJD226K025#CQYA	D	22	25	85	17	125	0.55	6	400	3	612	551	245
TMJD226K025#C^C	D	22	25	85	17	125	2.75	6	400	3	612	551	245
TMJD336K025#CQYA	D	33	25	85	17	125	0.82	6	400	3	612	551	245
TMJD336K025#C^C	D	33	25	85	17	125	4.13	6	400	3	612	551	245
TMJD476K025#C^C	D	47	25	85	17	125	5.88	6	400	3	612	551	245
TMJU686K025#CQXC	U	68	25	85	17	125	8.5	12	450	3	606	545	242
TMJU107K025#CQXC	U	100	25	85	17	125	12.5	12	450	3	606	545	242
35 Volt @ 85°C													
TMJA334K035#CQXC	A	0.33	35	85	23	125	0.1	4	6000	3	112	101	45
TMJA474K035#CQXC	A	0.47	35	85	23	125	0.1	4	6000	3	112	101	45
TMJA684K035#CQXC	A	0.68	35	85	23	125	0.12	4	6000	3	112	101	45
TMJB105K035#CQXC	B	1	35	85	23	125	0.18	4	2500	3	184	166	74
TMJB155K035#C^C	B	1.5	35	85	23	125	0.26	6	2500	3	184	166	74
TMJB225K035#C^C	B	2.2	35	85	23	125	0.39	6	2500	3	184	166	74
TMJB335K035#C^C	B	3.3	35	85	23	125	0.58	6	2500	3	184	166	74
TMJC475K035#CQYA	C	4.7	35	85	23	125	0.16	6	600	3	428	385	171
TMJC475K035#C^C	C	4.7	35	85	23	125	0.82	6	600	3	428	385	171
TMJC685K035#C^C	C	6.8	35	85	23	125	1.19	6	600	3	428	385	171
TMJC106K035#C^C	C	10	35	85	23	125	1.75	6	600	3	428	385	171
TMJD156K035#CQYA	D	15	35	85	23	125	0.52	6	400	3	612	551	245
TMJD156K035#C^C	D	15	35	85	23	125	2.63	6	400	3	612	551	245
TMJD226K035#CQYA	D	22	35	85	23	125	0.77	6	400	3	612	551	245
TMJD226K035#C^C	D	22	35	85	23	125	3.85	6	400	3	612	551	245
TMJE336K035#CQYA	E	33	35	85	23	125	1.15	6	250	3	812	731	325
TMJE336K035#C^C	E	33	35	85	23	125	5.78	6	250	3	812	731	325
TMJU476K035#CQXC	U	47	35	85	23	125	8.23	12	300	3	742	667	297
TMJU476K035#CQYA	U	47	35	85	23	125	1.64	12	300	3	742	667	297
50 Volt @ 85°C													
TMJA224K050#CQXC	A	0.22	50	85	33	125	0.1	4	7000	3	104	93	41
TMJA334K050#CQXC	A	0.33	50	85	33	125	0.1	4	7000	3	104	93	41
TMJB474K050#CQXC	B	0.47	50	85	33	125	0.12	4	2000	3	206	186	82
TMJB684K050#CQXC	B	0.68	50	85	33	125	0.17	4	2000	3	206	186	82
TMJC105K050#C^C	C	1	50	85	33	125	0.25	4	1500	3	271	244	108
TMJC155K050#C^C	C	1.5	50	85	33	125	0.38	6	1500	3	271	244	108
TMJC225K050#CQYA	C	2.2	50	85	33	125	0.11	6	1500	3	271	244	108
TMJC225K050#C^C	C	2.2	50	85	33	125	0.55	6	1500	3	271	244	108
TMJC335K050#CQYA	C	3.3	50	85	33	125	0.17	6	1500	3	271	244	108
TMJC335K050#C^C	C	3.3	50	85	33	125	0.83	6	1500	3	271	244	108
TMJD475K050#C^C	D	4.7	50	85	33	125	1.18	4.5	600	3	500	450	200
TMJD685K050#C^C	D	6.8	50	85	33	125	1.7	4.5	600	3	500	450	200
TMJE106K050#CQYA	E	10	50	85	33	125	0.5	4.5	400	3	642	578	257
TMJE106K050#C^C	E	10	50	85	33	125	2.5	4.5	400	3	642	578	257
TMJU156K050#CQXC	U	15	50	85	33	125	3.75	12	450	3	606	545	242
TMJU226K050#CQXC	U	22	50	85	33	125	5.5	12	450	3	606	545	242

Moisture Sensitivity Level (MSL) is defined according to J-STD-020.

All technical data relates to an ambient temperature of +25°C. Capacitance and DF are measured at 120Hz, 0.5V RMS with a maximum DC bias of 2.2 volts. DCL is measured at rated voltage after 5 minutes.

The EIA & CECC standards for low ESR Solid Tantalum Capacitors allow an ESR movement to 1.25 times catalogue limit post mounting.

NOTE: AVX reserves the right to supply a higher voltage rating or tighter tolerance part in the same case size, to the same reliability standards.

TMJ Tantalum SMD S1gma™ Series Capacitors



QUALIFICATION TABLE

TEST	TMJ S1gma™ series (Temperature range -55°C to +125°C)										
	Condition			Characteristics							
Endurance	Determine after application of rated voltage for 2000 +48/-0 hours at 85±2°C and then leaving 1-2 hours at room temperature. Also determine of 125°C temperature, category voltage for 2000 +48/-0 hours and then leaving 1-2 hours at room temperature. Power supply impedance to be ≤0.1Ω/V.			Visual examination	no visible damage						
				DCL	2 x initial limit						
				ΔC/C	within ±10% of initial value						
				DF	initial limit						
				ESR	1.25 x initial limit						
Storage Life	Determine after application of 125°C temperature, unpowered for 2000 +48/-0 hours at 125 ± 2°C and then leaving 1 - 2 hours at room temperature.			Visual examination	no visible damage						
				DCL	2 x initial limit						
				ΔC/C	within ±10% of initial value						
				DF	initial limit						
				ESR	1.25 x initial limit						
Humidity	Determine after leaving for 500 hours at 65 ± 2°C and 90 - 95% relative humidity and then leaving 1 - 2 hours at room temperature.			Visual examination	no visible damage						
				DCL	3 x initial limit						
				ΔC/C	within ±10% of initial value						
				DF	1.2 x initial limit						
				ESR	1.25 x initial limit						
Biased Humidity	Determine after leaving for 1000 hours at 85±2°C, 85% relative humidity and rated voltage and then recovery 1-2 hours at room temperature.			Visual examination	no visible damage						
				DCL	3 x initial limit						
				ΔC/C	within ±10% of initial value						
				DF	1.2 x initial limit						
				ESR	1.25 x initial limit						
Temperature Stability	Step	Temperature°C	Duration(min)		+20°C	-55°C	+20°C	+85°C	+125°C	+20°C	
	1	+20±2	15	DCL	IL*	n/a	IL*	10 x IL*	15 x IL*	1.5 x IL*	
	2	-55+0/-3	15		ΔC/C	n/a	+0/-10%	±5%	+10/-0%	+15/-0%	±5%
	3	+20±2	15	DF		IL*	1.5 x IL*	IL*	1.5 x IL*	2 x IL*	IL*
	4	+85+3/-0	15		ESR	1.25 x IL*	2.5 x IL*	1.25 x IL*	1.25 x IL*	1.25 x IL*	1.25 x IL*
	5	+125+3/-0	15								
	6	+20±2	15								
Surge Voltage	Test temperature: 125°C+3/0°C Test voltage: Category voltage at 125°C Surge voltage: 1.3 x category voltage at 125°C Series protection resistance 1000±100Ω Discharge resistance: 1000Ω Number of cycles: 1000x Cycle duration: 6 min (30 sec charge, 5 min 30 sec discharge)			Visual examination	no visible damage						
				DCL	2 x initial limit						
				ΔC/C	within ±5% of initial value						
				DF	initial limit						
				ESR	1.25 x initial limit						

*Initial Limit

THJ Series



High Temperature Tantalum Chip Capacitor



FEATURES

- Improved reliability – 2x standard
- 175°C @ 0.5V_R continuous operation
- CV range: 0.10-220µF / 6.3-50V
- 5 case sizes available
- Low ESR options on approval
- High temperature automotive and industry applications



SnPb termination option is not RoHS compliant.

APPLICATIONS

- Automotive ECU and ABS control electronics
- Geothermal instrumentation

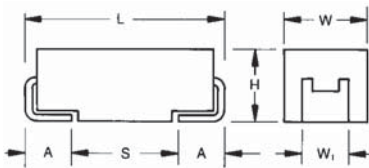

CASE DIMENSIONS: millimeters (inches)

Code	EIA Code	EIA Metric	L±0.20 (0.008)	W+0.20 (0.008) -0.10 (0.004)	H+0.20 (0.008) -0.10 (0.004)	W ₁ ±0.20 (0.008)	A+0.30 (0.012) -0.20 (0.008)	S Min.
A	1206	3216-18	3.20 (0.126)	1.60 (0.063)	1.60 (0.063)	1.20 (0.047)	0.80 (0.031)	1.10 (0.043)
B	1210	3528-21	3.50 (0.138)	2.80 (0.110)	1.90 (0.075)	2.20 (0.087)	0.80 (0.031)	1.40 (0.055)
C	2312	6032-28	6.00 (0.236)	3.20 (0.126)	2.60 (0.102)	2.20 (0.087)	1.30 (0.051)	2.90 (0.114)
D	2917	7343-31	7.30 (0.287)	4.30 (0.169)	2.90 (0.114)	2.40 (0.094)	1.30 (0.051)	4.40 (0.173)
E	2917	7343-43	7.30 (0.287)	4.30 (0.169)	4.10 (0.162)	2.40 (0.094)	1.30 (0.051)	4.40 (0.173)

W₁ dimension applies to the termination width for A dimensional area only.

MARKING A, B, C, D, E CASE

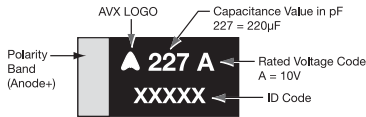

HOW TO ORDER

THJ	B	105	*	035	R	JN	-
Type	Case Size See table above	Capacitance Code pF code: 1st two digits represent significant figures 3rd digit represents multiplier (number of zeros to follow)	Tolerance K=±10% M=±20%	Rated DC Voltage 006=6.3Vdc 010=10Vdc 016=16Vdc 020=20Vdc 025=25Vdc 035=35Vdc 050=50Vdc	Packaging R = Pure Tin 7" Reel S = Pure Tin 13" Reel A = Gold Plating 7" Reel (Contact Manufacturer) B = Gold Plating 13" Reel (Contact Manufacturer) H = Tin Lead 7" Reel (Contact Manufacturer) K = Tin Lead 13" Reel (Contact Manufacturer) H, K = Non RoHS	Standard Suffix OR 0100 Low ESR in mΩ	Additional characters may be added for special requirements V = Dry pack Option

TECHNICAL SPECIFICATIONS

Technical Data:	All technical data relate to an ambient temperature of +25°C								
Capacitance Range:	0.10 µF to 220 µF								
Capacitance Tolerance:	±10%; ±20%								
Rated Voltage (V _R)	≤ +85°C:	6.3	10	16	20	25	35	50	
Category Voltage (V _C)	≤ +125°C:	4	7	10	13	17	23	33	
Category Voltage (V _C)	≤ +175°C:	3	5	8	10	12	17	25	
Surge Voltage (V _S)	≤ +85°C:	8	13	20	26	32	46	65	
Surge Voltage (V _S)	≤ +125°C:	5	8	13	16	20	28	40	
Surge Voltage (V _S)	≤ +175°C:	4	6	10	12	15	21	30	
Temperature Range:	-55°C to 175°C voltage derating.								
Reliability:	0.5% per 1000 hours at 85°C, V _R with 0.1Ω/V series impedance, 60% confidence level, 3.5 Fits at 40°C, 0.5V _R								
Termination Finish:	Sn Plating (standard), Gold and SnPb Plating upon request								
	Meets requirements of AEC-Q200								



High Temperature Tantalum Chip Capacitor

CAPACITANCE AND RATED VOLTAGE RANGE (LETTER DENOTES CASE SIZE)

Capacitance		Rated voltage (V_R) to 85°C (Voltage Code)						
μF	Code	6.3V (J)	10V (A)	16V (C)	20V (D)	25V (E)	35V (V)	50V (T)
0.10	104						A	
0.15	154						A	
0.22	224						A	
0.33	334						A	
0.47	474					A	B	
0.68	684					A	B	
1.0	105						A	
1.5	155				A		A/B	
2.2	225			A, A(1500)		B, B(1500)	C	
3.3	335		A	A	B		C	D
4.7	475	A	A	A/B			C	D
6.8	685	A	A	A/B		C	D	D
10	106	A	A/B	B		C	D	D/E
15	156	B	B	B	C		D	
22	226	B	B	C, C(500)		D	D, D(300)	
33	336	B	C	C	D	D	E, E(150)	
47	476	C	C	C/D				
68	686	C	D	D				
100	107	D	D	E				
150	157	D						
220	227		E					

Released ratings (ESR ratings in mOhms in parenthesis)

Engineering samples - please contact AVX

*Ratings under development – subject to change.

Note: Voltage ratings are minimum values. AVX reserves the right to supply higher ratings in the same case size, to the same reliability standards.

THJ 175°C Voltage vs Temperature Rating

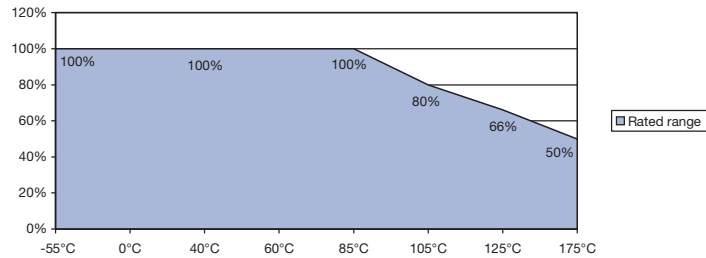

THJ Series



High Temperature Tantalum Chip Capacitor

RATINGS & PART NUMBER REFERENCE

AVX Part No.	Case Size	Capacitance (μF)	Rated Voltage (V)	Rated Temperature (°C)	Category Voltage (V)	Category Temperature (°C)	DCL Max. (μA)	DF Max. (%)	ESR Max. @ 100kHz (Ω)	MSL	100kHz RMS Current (mA)			
											25°C	85°C	125°C	175°C
6.3 Volt @ 85°C														
THJA475*006#JN	A	4.7	6.3	85	3	175	0.5	6	6	1	112	101	45	22
THJA685*006#JN	A	6.8	6.3	85	3	175	0.5	4.5	2.6	1	170	153	68	34
THJA106*006#JN	A	10	6.3	85	3	175	0.6	4.5	2.2	1	185	166	74	37
THJB156*006#JN	B	15	6.3	85	3	175	0.9	6	2.5	1	184	166	74	37
THJB226*006#JN	B	22	6.3	85	3	175	1.4	6	2.5	1	184	166	74	37
THJB336*006#JN	B	33	6.3	85	3	175	1.9	6	2.2	1	197	177	79	39
THJC476*006#JN	C	47	6.3	85	3	175	3.0	6	1.6	1	262	236	105	52
THJC686*006#JN	C	68	6.3	85	3	175	4.3	6	1.5	1	271	244	108	54
THJD107*006#JN	D	100	6.3	85	3	175	6	4.5	0.4	1 ^U	612	551	245	122
THJD157*006#JN	D	150	6.3	85	3	175	9.5	6	0.9	1 ^U	408	367	163	82
10 Volt @ 85°C														
THJA335*010#JN	A	3.3	10	85	5	175	0.5	6	5.5	1	117	105	47	23
THJA475*010#JN	A	4.7	10	85	5	175	0.5	4.5	2.9	1	161	145	64	32
THJA685*010#JN	A	6.8	10	85	5	175	0.7	4.5	2.6	1	170	153	68	34
THJA106*010#JN	A	10	10	85	5	175	1	6	2.7	1	167	150	67	33
THJB106*010#JN	B	10	10	85	5	175	1	4.5	1.8	1	217	196	87	43
THJB156*010#JN	B	15	10	85	5	175	1.5	4.5	1.5	1	238	214	95	48
THJB226*010#JN	B	22	10	85	5	175	2.2	6	2.4	1	188	169	75	38
THJC336*010#JN	C	33	10	85	5	175	3.3	6	1.6	1	262	236	105	52
THJC476*010#JN	C	47	10	85	5	175	4.7	4.5	0.5	1	469	422	188	94
THJD686*010#JN	D	68	10	85	5	175	6.8	4.5	0.4	1 ^U	612	551	245	122
THJD107*010#JN	D	100	10	85	5	175	10	6	0.9	1 ^U	408	367	163	82
THJE227*010#JN	E	220	10	85	5	175	22	10	0.5	1 ^U	574	517	230	115
16 Volt @ 85°C														
THJA225*016#JN	A	2.2	16	85	8	175	0.5	4.5	3	1	158	142	63	32
THJA225*016#1500	A	2.2	16	85	8	175	0.5	4.5	1.5	1	224	201	89	45
THJA335*016#JN	A	3.3	16	85	8	175	0.5	6	5	1	122	110	49	24
THJA475*016#JN	A	4.7	16	85	8	175	0.8	4.5	2.9	1	161	145	64	32
THJB475*016#JN	B	4.7	16	85	8	175	0.8	6	3.5	1	156	140	62	31
THJA685*016#JN	A	6.8	16	85	8	175	1.1	6	3.5	1	146	132	59	29
THJB685*016#JN	B	6.8	16	85	8	175	1.1	6	2.5	1	184	166	74	37
THJB106*016#JN	B	10	16	85	8	175	1.6	4.5	2.8	1	174	157	70	35
THJB156*016#JN	B	15	16	85	8	175	2.4	6	2	1	206	186	82	41
THJC226*016#JN	C	22	16	85	8	175	3.5	6	1.6	1	262	236	105	52
THJC226*016#0500	C	22	16	85	8	175	3.5	4.5	0.5	1	469	422	188	94
THJC336*016#JN	C	33	16	85	8	175	5.3	6	1.5	1	271	244	108	54
THJC476*016#JN	C	47	16	85	8	175	7.5	6	0.9	1	371	334	148	74
THJD476*016#JN	D	47	16	85	8	175	7.5	6	0.9	1 ^U	408	367	163	82
THJD686*016#JN	D	68	16	85	8	175	10.9	4.5	0.9	1 ^U	408	367	163	82
THJE107*016#JN	E	100	16	85	8	175	16	8	0.4	1 ^U	642	578	257	128
20 Volt @ 85°C														
THJA155*020#JN	A	1.5	20	85	10	175	0.5	6	6.5	1	107	97	43	21
THJB335*020#JN	B	3.3	20	85	10	175	0.7	6	3	1	168	151	67	34
THJC156*020#JN	C	15	20	85	10	175	3.0	6	1.7	1	254	229	102	51
THJD336*020#JN	D	33	20	85	10	175	6.6	6	0.9	1 ^U	408	367	163	82
25 Volt @ 85°C														
THJA474*025#JN	A	0.47	25	85	12	175	0.5	4	14	1	73	66	29	15
THJA684*025#JN	A	0.68	25	85	12	175	0.5	4	10	1	87	78	35	17
THJA105*025#JN	A	1.0	25	85	12	175	0.5	3	5.2	1	120	108	48	24
THJB225*025#JN	B	2.2	25	85	12	175	0.6	6	4.5	1	137	124	55	27
THJB225*025#1500	B	2.2	25	85	12	175	0.6	6	1.5	1	238	214	95	48
THJC685*025#JN	C	6.8	25	85	12	175	1.7	6	2	1	235	211	94	47
THJC106*025#JN	C	10	25	85	12	175	2.5	6	1.8	1	247	222	99	49
THJD226*025#JN	D	22	25	85	12	175	5.5	6	0.9	1 ^U	408	367	163	82
THJD336*025#JN	D	33	25	85	12	175	8.3	6	0.9	1 ^U	408	367	163	82
35 Volt @ 85°C														
THJA104*035#JN	A	0.1	35	85	17	175	0.5	4	24	1	56	50	22	11
THJA154*035#JN	A	0.15	35	85	17	175	0.5	4	21	1	60	54	24	12
THJA224*035#JN	A	0.22	35	85	17	175	0.5	4	18	1	65	58	26	13
THJA334*035#JN	A	0.33	35	85	17	175	0.5	4	15	1	71	64	28	14
THJB474*035#JN	B	0.47	35	85	17	175	0.5	4	10	1	92	83	37	18
THJB684*035#JN	B	0.68	35	85	17	175	0.5	4	8	1	103	93	41	21
THJA105*035#JN	A	1.0	35	85	17	175	0.5	4	7.5	1	100	90	40	20
THJB105*035#JN	B	1.0	35	85	17	175	0.5	4	6.5	1	114	103	46	23
THJC155*035#JN	C	1.5	35	85	17	175	0.5	6	4.5	1	156	141	63	31
THJC225*035#JN	C	2.2	35	85	17	175	0.8	6	3.5	1	177	160	71	35
THJC335*035#JN	C	3.3	35	85	17	175	1.2	6	2.5	1	210	189	84	42
THJC475*035#JN	C	4.7	35	85	17	175	1.6	6	2.2	1	224	201	89	45
THJD685*035#JN	D	6.8	35	85	17	175	2.4	6	1.3	1 ^U	340	306	136	68

RATINGS & PART NUMBER REFERENCE

AVX Part No.	Case Size	Capacitance (μF)	Rated Voltage (V)	Rated Temperature (°C)	Category Voltage (V)	Category Temperature (°C)	DCL Max. (μA)	DF Max. (%)	ESR Max. @ 100kHz (Ω)	MSL	100kHz RMS Current (mA)				
											25°C	85°C	125°C	175°C	
THJD106*035#JN	D	10	35	85	17	175	3.5	6	1	1 ¹⁾	387	349	155	77	
THJD156*035#JN	D	15	35	85	17	175	5.3	6	0.9	1 ¹⁾	408	367	163	82	
THJD226*035#JN	D	22	35	85	17	175	7.7	6	0.6	1 ¹⁾	500	450	200	100	
THJD226*035#0300	D	22	35	85	17	175	7.7	6	0.3	1 ¹⁾	707	636	283	141	
THJE336*035#JN	E	33	35	85	17	175	11.6	6	0.5	1 ¹⁾	574	517	230	115	
THJE336*035#0150	E	33	35	85	17	175	11.6	6	0.15	1 ¹⁾	1049	944	420	210	
50 Volt @ 85°C															
THJD335*050#JN	D	3.3	50	85	25	175	1.7	6	1.1	1 ¹⁾	369	332	148	74	
THJD475*050#JN	D	4.7	50	85	25	175	2.4	6	0.9	1 ¹⁾	463	417	185	93	
THJD685*050#JN	D	6.8	50	85	25	175	3.4	6	0.7	1 ¹⁾	408	367	163	82	
THJD106*050#JN	D	10	50	85	25	175	5	6	0.7	1 ¹⁾	463	417	185	93	
THJE106*050#JN	E	10	50	85	25	175	5	6	0.7	1 ¹⁾	486	437	194	97	

Moisture Sensitivity Level (MSL) is defined according to J-STD-020.

All PNs also available with Dry pack option - MSL 3 (see How to order).

¹⁾ -Dry pack option (see How to order) is recommended for reduction of stress during soldering.

All technical data relates to an ambient temperature of +25°C. Capacitance and DF are measured at 120Hz, 0.5V RMS with a maximum DC bias of 2.2 volts. DCL is measured at rated voltage after 5 minutes.

The EIA & CECC standards for low ESR Solid Tantalum Capacitors allow an ESR movement to 1.25 times catalogue limit post mounting.

For typical weight and composition see page 222.

NOTE: AVX reserves the right to supply a higher voltage rating or tighter tolerance part in the same case size, to the same reliability standards.

QUALIFICATION TABLE

TEST	THJ series (Temperature range -55°C to +175°C)									
	Condition			Characteristics						
Endurance	Determine after application of rated voltage for 2000 +48/-0 hours at 85±2°C and then leaving 1-2 hours at room temperature. Also determine of 175°C temperature, category voltage for 2000 +48/-0 hours and then leaving 1-2 hours at room temperature. Power supply impedance to be ≤0.1Ω/V.			Visual examination	no visible damage					
				DCL	1.25 x initial limit					
				ΔC/C	within ±10% of initial value					
				DF	initial limit					
				ESR	1.25 x initial limit					
Storage Life	175°C, 0V, 2000h			Visual examination	no visible damage					
				DCL	1.25 x initial limit					
				ΔC/C	within ±10% of initial value					
				DF	initial limit					
				ESR	1.25 x initial limit					
Biased Humidity	Determine after leaving for 1000 hours at 85±2°C, 85% relative humidity and rated voltage and then recovery 1-2 hours at room temperature.			Visual examination	no visible damage					
				DCL	2 x initial limit					
				ΔC/C	within ±10% of initial value					
				DF	1.2 x initial limit					
				ESR	1.25 x initial limit					
Temperature Stability	Step	Temperature°C	Duration(min)		+20°C	-55°C	+20°C	+125°C	+175°C	+20°C
	1	+20±2	15	DCL	IL*	n/a	IL*	10 x IL*	12.5 x IL*	IL*
	2	-55+0/-3	15		ΔC/C	n/a	+0/-10%	±5%	+10/-0%	+18/-0%
	3	+20±2	15	DF		IL*	1.5 x IL*	IL*	1.5 x IL*	2 x IL*
	4	+125+3/-0	15		ESR	1.25 x IL*	2.5 x IL*	1.25 x IL*	1.25 x IL*	1.25 x IL*
	5	+175+3/-0	15							
	6	+20±2	15							
Surge Voltage	Test temperature: 175°C±3/0°C Test voltage: 1.3 x category voltage at 175°C Series protection resistance 1000±100Ω Discharge resistance: 1000Ω Number of cycles: 1000x Cycle duration: 6 min; 30 sec charge, 5 min 30 sec discharge			Visual examination	no visible damage					
				DCL	initial limit					
				ΔC/C	within ±5% of initial value					
				DF	initial limit					
				ESR	1.25 x initial limit					
Mechanical Shock	MIL-STD-202, Method 213, Condition F			Visual examination	no visible damage					
				DCL	initial limit					
				ΔC/C	within ±5% of initial value					
				DF	initial limit					
				ESR	1.25 x initial limit					
Vibration	MIL-STD-202, Method 204, Condition D			Visual examination	no visible damage					
				DCL	initial limit					
				ΔC/C	within ±5% of initial value					
				DF	initial limit					
				ESR	1.25 x initial limit					

*Initial Limit

THJ Series with Extension to 200°C



High Temperature Tantalum Chip Capacitor

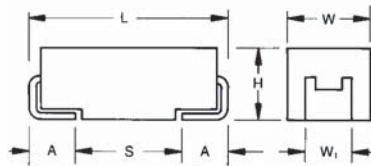

FEATURES

- SMD 200°C tantalum capacitor
- 200°C @ 0.33V_R 1000hrs continuous operation
- Leakage current after 200°C 1000hrs less than 1mA
- 3x reflow 260°C
- Gold plated termination for hybrid assembly
- Oil drilling, aerospace, automotive applications
- CV range: 10-220μF / 10-50V
- 3 case sizes available

APPLICATIONS

- Downhole drilling



LEAD-FREE
LEAD-FREE COMPATIBLE
COMPONENT



RoHS
COMPLIANT

CASE DIMENSIONS: millimeters (inches)

Code	EIA Code	EIA Metric	L±0.20 (0.008)	W±0.20 (0.008) -0.10 (0.004)	H±0.20 (0.008) -0.10 (0.004)	W ₁ ±0.20 (0.008)	A±0.30 (0.012) -0.20 (0.008)	S Min.
B	1210	3528-21	3.50 (0.138)	2.80 (0.110)	1.90 (0.075)	2.20 (0.087)	0.80 (0.031)	1.40 (0.055)
D	2917	7343-31	7.30 (0.287)	4.30 (0.169)	2.90 (0.114)	2.40 (0.094)	1.30 (0.051)	4.40 (0.173)
E	2917	7343-43	7.30 (0.287)	4.30 (0.169)	4.10 (0.162)	2.40 (0.094)	1.30 (0.051)	4.40 (0.173)

W₁ dimension applies to the termination width for A dimensional area only.

MARKING

B, D, E CASE

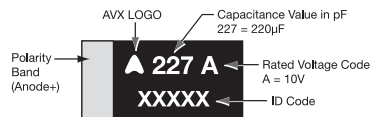

Engineering samples

HOW TO ORDER

THJ	E	107	*	016	#	JH	-
Type	Case Size See table above	Capacitance Code pF code: 1st two digits represent significant figures 3rd digit represents multiplier (number of zeros to follow)	Tolerance K = ±10% M = ±20%	Rated DC Voltage 010 = 10Vdc 016 = 16Vdc 035 = 35Vdc 050 = 50Vdc	Packaging A = Gold Plating 7" Reel B = Gold Plating 13" Reel	Standard Suffix	Additional characters may be added for special requirements V = Dry pack Option

TECHNICAL SPECIFICATIONS

Technical Data:	All technical data relate to an ambient temperature of +25°C					
Capacitance Range:	6.8 μF to 220 μF					
Capacitance Tolerance:	±10%; ±20%					
Leakage Current DCL @ V _R 25°C	0.01CV					
Leakage Current DCL @ V _C 200°C, 1000 hrs	1mA					
Rated Voltage (V _R)	≤ +85°C:	10	16	35	50	
Category Voltage (V _C)	≤ +200°C:	3.3	5.3	12	17	
Surge Voltage (V _S)	≤ +85°C:	13	20	44	63	
Surge Voltage (V _S)	≤ +200°C:	4.3	6.5	14	21	
Temperature Range:	-55°C up 200°C with voltage derating					
Reliability:	0.5% per 1000 hours at 85°C, V _R with 0.1Ω/V series impedance, 1000 hrs at 200°C, 0.33V _R					
Termination Finished:	Gold Plating Meets requirements of AEC-Q200					

THJ Series with Extension to 200°C



High Temperature Tantalum Chip Capacitor

CAPACITANCE AND RATED VOLTAGE RANGE (LETTER DENOTES CASE SIZE)

Capacitance		Rated voltage (V _R) to 85°C (Voltage Code)				
μF	Code	10V (A)	16V (C)	25V (E)	35V (V)	50V (T)
6.8	685					E*
10	106		B			E
15	156					
22	226				D,E*	
33	336			E*	E	
47	476			E*		
68	686					
100	107		E			
150	157					
220	227	E				

Available Ratings

Engineering samples - please contact manufacturer

*Codes under development - subject to change

Note: Voltage ratings are minimum values. AVX reserves the right to supply higher ratings in the same case size, to the same reliability standards.

RATINGS & PART NUMBER REFERENCE

AVX Part No.	Case Size	Capacitance (μF)	Rated Voltage (V)	Rated Temperature (°C)	Category Voltage (V)	Category Temperature (°C)	DCL Max. @ V _R 25°C (μA)	DCL Max. @ V _C 200°C 1000 hrs (mA)	DF Max. (%)	ESR Max. @ 100kHz (Ω)	MSL	100kHz RMS Current (mA)			
												25°C	85°C	175°C	200°C
10 Volt @ 85°C															
THJE227*010#JH	E	220	10	85	3.3	200	22	1.0	10	0.25	1 ¹⁾	812	731	162	81
16 Volt @ 85°C															
THJB106*016#JH	B	10	16	85	5.3	200	1.6	1.0	6	2.8	1	174	157	35	17
THJE107*016#JH	E	100	16	85	5.3	200	16	1.0	8	0.25	1 ¹⁾	812	731	162	81
35 Volt @ 85°C															
THJD226*035#JH	D	22	35	85	12	200	7.7	1.0	6	0.6	1 ¹⁾	500	450	100	50
THJE336*035#JH	E	33	35	85	12	200	11.6	1.0	6	0.5	1 ¹⁾	574	517	115	57
50 Volt @ 85°C															
THJE106*050#JH	E	10	50	85	17	200	5	1.0	6	0.7	1 ¹⁾	486	437	97	49

Moisture Sensitivity Level (MSL) is defined according to J-STD-020.

All PNs also available with Dry pack option - MSL 3 (see How to order).

¹⁾ -Dry pack option (see How to order) recommended for reduction of stress during soldering.

Base terminations material is copper for E case size and Ni42 for B case size.

All technical data relates to an ambient temperature of +25°C. Capacitance and DF are measured at 120Hz, 0.5V RMS with a maximum DC bias of 2.2 volts. DCL is measured at rated voltage after 5 minutes.

For typical weight and composition see page 222.

NOTE: AVX reserves the right to supply a higher voltage rating or tighter tolerance part in the same case size, to the same reliability standards.

THJ Series with Extension to 200°C



High Temperature Tantalum Chip Capacitor

QUALIFICATION TABLE

TEST	THJ 200°C series (Temperature range -55°C to +200°C)									
	Condition			Characteristics						
Endurance	Determine after application of rated voltage for 2000 +48/-0 hours at 85±2°C and then leaving 1-2 hours at room temperature. Also determine of 200°C temperature, category voltage for 2000 +48/-0 hours and then leaving 1-2 hours at room temperature. Power supply impedance to be ≤0.1Ω/V.			Visual examination	no visible damage					
				DCL	1.25 x initial limit					
				ΔC/C	within ±10% of initial value					
				DF	initial limit					
				ESR	1.25 x initial limit					
Storage Life	200°C, 0V, 2000h			Visual examination	no visible damage					
				DCL	1.25 x initial limit					
				ΔC/C	within ±10% of initial value					
				DF	initial limit					
				ESR	1.25 x initial limit					
Biased Humidity	Determine after leaving for 1000 hours at 85±2°C, 85% relative humidity and rated voltage and then recovery 1-2 hours at room temperature.			Visual examination	no visible damage					
				DCL	2 x initial limit					
				ΔC/C	within ±10% of initial value					
				DF	1.2 x initial limit					
				ESR	1.25 x initial limit					
Temperature Stability	Step	Temperature°C	Duration(min)		+20°C	-55°C	+20°C	+125°C	+200°C	+20°C
	1	+20±2	15	DCL	IL*	n/a	IL*	10 x IL*	12.5 x IL*	IL*
	2	-55+0/-3	15		ΔC/C	n/a	+0/-10%	±5%	+10/-0%	+18/-0%
	3	+20±2	15	DF		IL*	1.5 x IL*	IL*	1.5 x IL*	2 x IL*
	4	+125+3/-0	15		ESR	1.25 x IL*	2.5 x IL*	1.25 x IL*	1.25 x IL*	1.25 x IL*
	5	+200+3/-0	15							
	6	+20±2	15							
Surge Voltage	Test temperature: 200°C±3/0°C Test voltage: 1.3 x category voltage at 200°C Series protection resistance 1000±100Ω Discharge resistance: 1000Ω Number of cycles: 1000x Cycle duration: 6 min; 30 sec charge, 5 min 30 sec discharge			Visual examination	no visible damage					
				DCL	initial limit					
				ΔC/C	within ±5% of initial value					
				DF	initial limit					
				ESR	1.25 x initial limit					

*Initial Limit

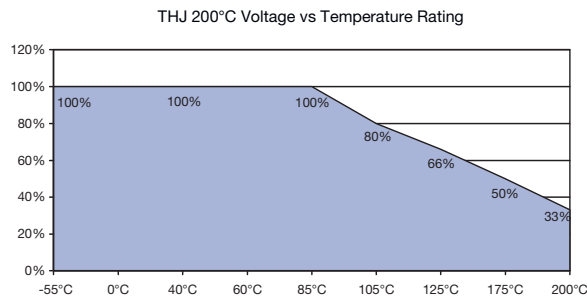

THH 230°C Hermetic Series



SMD 230°C High Temperature Tantalum Capacitor in Hermetic Package



FEATURES

- High temperature applications
- Operational condition 230°C / 0.5U_R / 1000hrs (2000hrs for selected codes) or 200°C / 0.5U_R / 10,000hrs
- Ceramic case hermetic packaging
- Large case sizes including CTC-21D provide high capacitance values
- Manufacturing and screening utilizing AVX patented Q-Process to effectively remove components that may experience excessive parametric shifts or instability in operation life



APPLICATIONS

- Oil drilling
- Extreme temperature applications

For additional information on Q-process please consult the AVX technical publication "Reaching the Highest Reliability for Tantalum Capacitors" (see the link: <http://www.avx.com/docs/techinfo/Qprocess.pdf>)

MARKING

9, I CASE

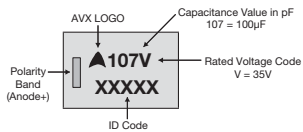

CASE DIMENSIONS: millimeters (inches)

Code	Type	L±0.50 (0.020)	W±0.50 (0.020)	H Max.	W ₁ ±0.50 (0.020)	A±0.50 (0.020)	S Min.
9 (CTC-21D)	J-lead (L-shape)	11.50 (0.453)	12.50 (0.492)	6.15 (0.242)	12.50 (0.492)	1.90 (0.075)	7.00 (0.276)
9 (CTC-21D)	J-lead (flex)	12.10 (0.476)	12.50 (0.492)	6.50 (0.256)	12.00 (0.472)	2.00 (0.079)	7.20 (0.283)
9 (CTC-21D)	Undertab	11.00 ± 0.20 (0.433 ± 0.008)	12.50 ± 0.20 (0.492 ± 0.008)	5.95 (0.234)	10.50 ± 0.20 (0.413 ± 0.008)	1.50 ± 0.20 (0.059 ± 0.008)	7.80 (0.307)
I	J-lead (L-shape)	11.50 (0.453)	6.00 (0.236)	2.70 (0.106)	6.00 (0.236)	3.50 (0.138)	4.00 (0.157)
I	J-lead (flex)	11.90 (0.469)	6.00 (0.236)	3.00 (0.118)	5.50 (0.217)	3.60 (0.142)	4.20 (0.165)
I	Undertab	11.00 ± 0.20 (0.433 ± 0.008)	6.00 ± 0.20 (0.236 ± 0.008)	2.50 (0.098)	4.00 ± 0.20 (0.157 ± 0.008)	3.20 ± 0.20 (0.126 ± 0.008)	4.40 (0.173)

'J' Lead Termination (flex)

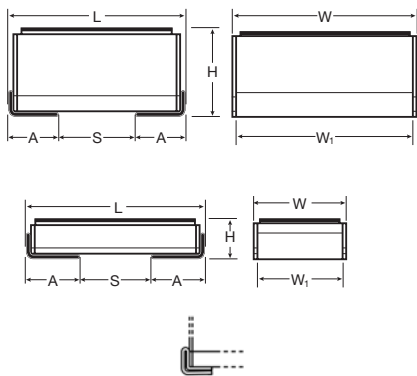

'J' Lead Termination (L-shape)

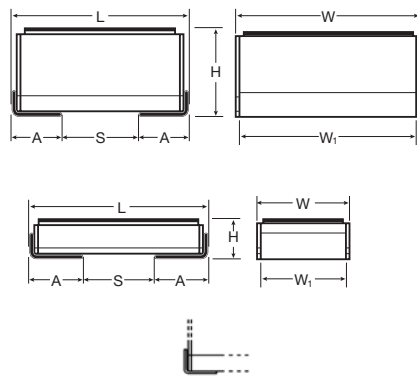

Undertab Termination

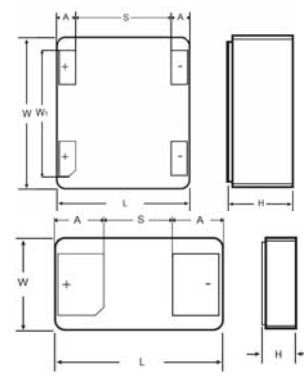

THH 230°C Hermetic Series



SMD 230°C High Temperature Tantalum Capacitor in Hermetic Package

TECHNICAL SPECIFICATIONS

Technical Data:	All technical data relate to an ambient temperature of +25°C							
Capacitance Range:	6.8 µF to 100 µF (for extended range under development, contact manufacturer)							
Capacitance Tolerance:	±20%							
Leakage Current DCL:	0.01CV							
Rated Voltage (V _R)	≤ +85°C:	16	20	25	35	50	63	
Category Voltage (V _C)	≤ +230°C:	8	10	12	17	25	31	
Temperature Range:	-55°C to +230°C							
Reliability:	1% per 1000 hours at 85°C, Vr with 0.1Ω/V series impedance, 60% confidence level							
Termination Finish:	Gold Plating (Undertab), Gold Plating (J-lead L shape), Nickel Plating (J-lead flex)							

HOW TO ORDER

AVX PART NUMBER

THH	9	107	M	035	W	0250	J
Type	Case Size See table above	Capacitance Code pF code: 1st two digits represent significant figures 3rd digit represents multiplier (number of zeros to follow)	Tolerance M = ±20%	Rated DC Voltage 016 = 16Vdc 020 = 20Vdc 025 = 25Vdc 035 = 35Vdc 050 = 50Vdc 063 = 63Vdc	Packaging W = Waffle B = Bulk	ESR in mΩ	Termination J = 'J' lead (L-shape) W = 'J' lead (flex) U = Undertab



CAPACITANCE AND VOLTAGE RANGE (CODE DENOTES THE CASE SIZE)

Capacitance		Rated Voltage DC (V _R) at 175°C					
µF	Code	16V (C)	20V (D)	25V (E)	35V (V)	50V (T)	63V (J)
4.7	475					I*	I*
6.8	685				I	I	
10	106				I		
15	156			I*			
22	226	I	I*				
33	336						
47	476	I				9*	9
68	686						
100	107				9		
150	157			9*			
220	227		9*				
330	337	9*					

Released ratings

Engineering samples - please contact AVX

*Ratings under development – upon request, please contact AVX

THH 230°C Hermetic Series



SMD 230°C High Temperature Tantalum Capacitor in Hermetic Package

VOLTAGE VS TEMPERATURE RATING

AVX Part No.	Case Size	Capacitance (μF)	Rated Voltage (V)	Rated Temperature (°C)	Category Voltage (V)	DCL Max. (μA)	DF Max. (%)	ESR Max. @ 100kHz (mΩ)	MSL	100kHz RMS Current (A)			Lifetime at 230°C (hrs)
										25°C	85°C	230°C	
16 Volt @ 85°C													
THHI226M016W0500#	I	22	16	175	8	3.6	8	500	1	0.81	0.73	0.73	2,000
THHI476M016W0500#	I	47	16	175	8	7.5	8	500	1	0.81	0.73	0.73	1,000
35 Volt @ 85°C													
THHI685M035W0500#	I	6.8	35	175	17	2.4	8	500	1	0.81	0.73	0.73	2,000
THHI106M035W0500#	I	10	35	175	17	3.5	8	500	1	0.81	0.73	0.73	2,000
THH9107M035W0250#	9	100	35	175	17	35	8	250	1	1.26	1.13	1.13	2,000
50 Volt @ 85°C													
THHI685M050W0500#	I	6.8	50	175	25	3.4	8	500	1	0.81	0.73	0.73	1,000
63 Volt @ 85°C													
THH9476M063W0250#	9	47	63	175	31	29.6	8	250	1	1.26	1.13	1.13	1,000

All technical data relates to an ambient temperature of +25°C. Capacitance and DF are measured at 120Hz, 0.5V RMS with a maximum DC bias of 2.2 volts.

DCL is measured at rated voltage after 5 minutes.

ESR change post 1000hrs allowed up to 3 times catalog limit.

Moisture Sensitivity Level (MSL) is defined according to J-STD-020.

VOLTAGE VS TEMPERATURE RATING

THH 230°C Voltage vs Temperature Rating for 1000 (or 2000) hrs service life

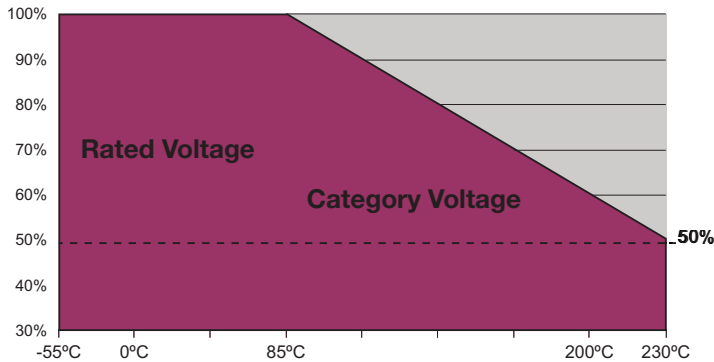

THH 230°C Hermetic Series



SMD 230°C High Temperature Tantalum Capacitor in Hermetic Package

QUALIFICATION TABLE

TEST	THH 230°C hermetic series (Temperature range -55°C to +230°C)													
	Condition			Characteristics										
Endurance	Determine after application of 230°C temperature, category voltage for 2000+48/-0 hours and then leaving min. 2 hours at room temperature. Power supply impedance to be <3Ω.			Visual examination	no visible damage									
				DCL	1.25 x initial limit									
				ΔC/C	within ±20% of initial value									
				DF	1.5 x initial limit									
				ESR	3 x initial limit									
Endurance	Determine after application of 0.5U _R for 10000+48/-0 hours at 200°C temperature and then leaving min. 2 hours at room temperature. Power supply impedance to be <3Ω.			Visual examination	no visible damage									
				DCL	1.25 x initial limit									
				ΔC/C	within ±20% of initial value									
				DF	1.5 x initial limit									
				ESR	3 x initial limit									
Storage Life	230°C, 0V, 1000h + 48/-0 hours			Visual examination	no visible damage									
				DCL	initial limit									
				ΔC/C	within ±5% of initial value									
				DF	initial limit									
				ESR	1.25 x initial limit									
Biased Humidity	Determine after leaving for 1000 hours at 85±2°C, 85% relative humidity and rated voltage and then recovery min. 2 hours at room temperature.			Visual examination	no visible damage									
				DCL	initial limit									
				ΔC/C	within ±10% of initial value									
				DF	initial limit									
				ESR	1.25 x initial limit									
Temperature Stability	Step	Temperature°C	Duration (min)		+20°C	-55°C	+20°C	+85°C	+125°C	+175°C	+200°C	+230°C	+20°C	
	1	+20	15											
	2	-55	15	DCL	IL*	n/a	IL*	10 x IL*	12.5 x IL*	n/a	n/a	n/a	IL*	
	3	+20	15											
	4	+85	15	ΔC/C	n/a	+0/-20%	±5%	+20/-0%	+30/-0%	+30/-0%	+30/-0%	+30/-0%	±5%	
	5	+125	15											
	6	+175	15	DF	IL*	1.5 x IL*	IL*	1.5 x IL*	2 x IL*	2 x IL*	2 x IL*	2 x IL*	IL*	
	7	+200	15											
	8	+230	15											
	9	+20	15	ESR	1.25 x IL*	1.25 x IL*	1.25 x IL*	1.25 x IL*	1.25 x IL*	1.25 x IL*	1.25 x IL*	1.25 x IL*	1.25 x IL*	
Surge Voltage	Test temperature: 85°C+3/0°C Surge voltage: 1.3 x rated voltage Series protection resistance: 33Ω Discharge resistance: 33Ω Number of cycles: 1000x Cycle duration: 5 min; 30 sec charge, 5 min 30 sec discharge			Visual examination	no visible damage									
				DCL	initial limit									
				ΔC/C	within ±20% of initial value									
				DF	initial limit									
				ESR	1.25 x initial limit									
Mechanical Shock/Vibration	MIL-STD-202, Method 213, Condition I, 100 G peak MIL-STD-202, Method 204, Condition D, 10 Hz to 2,000 Hz, 20 G peak			Visual examination	no visible damage									
				DCL	initial limit									
				ΔC/C	within ±10% of initial value									
				DF	initial limit									
				ESR	1.25 x initial limit									
Vibration 230°C	Determine after application of 230°C temperature and vibration frequency: 10 ~ 2000 ~ 10Hz in 20 min Full amplitude: 3 mm/20g Vibration directions time X, Y Z directions: 4 hours each direction: total 12 hrs.			Visual examination	no visible damage									
				DCL	initial limit									
				ΔC/C	within ±5% of initial value									
				DF	initial limit									
				ESR	1.25 x initial limit									

*Initial Limit

Standard and Low Profile Tantalum Microchip Capacitors



FEATURES

- The world's smallest surface mount tantalum capacitor
- CV range: 0.10-150µF / 2-25V
- 5 case sizes available
- 11 case sizes available, standard and low profile



LEAD-FREE COMPATIBLE COMPONENT



APPLICATIONS

- Hearing Aids, Non-life support medical, Long life miniature designs
- Industrial and hand-held and wearable applications

STANDARD CASE DIMENSIONS: millimeters (inches)

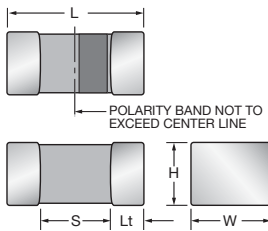

Code	EIA Code	EIA Metric	L+0.20 (0.008) -0.00 (0.000)	W+0.15 (0.006) -0.00 (0.000)	H+0.15 (0.006) -0.00 (0.000)	Termination Spacing(S)	Minimum Termination Length (Lt)
A	1206	3216-18	3.20 ± 0.20 (0.126 ± 0.008)	1.60 ± 0.20 (0.063 ± 0.008)	1.60 ± 0.20 (0.063 ± 0.008)	1.80 (0.071) min	0.15 (0.006)
B	1210	3528-15	3.50 ± 0.20 (0.138 ± 0.008)	2.80 ^{+0.20} _{-0.10} (0.110 ^{+0.008} _{-0.004})	1.50 (0.059) max	2.00 (0.079) min	0.15 (0.006)
K	0402	1005-07	1.00 (0.039)	0.50 ^{+0.20} _{-0.00} (0.020 ^{+0.008} _{-0.000})	0.50 ^{+0.20} _{-0.00} (0.020 ^{+0.008} _{-0.000})	0.40 (0.016) min	0.10 (0.004)
L	0603	1608-10	1.60 (0.063)	0.85 (0.033)	0.85 (0.033)	0.55 (0.022) min	0.15 (0.006)
R	0805	2012-15	2.00 (0.079)	1.35 (0.053)	1.35 (0.053)	0.70 (0.027) min	0.15 (0.006)

MARKING

A, B, H, I, J, K, L, R, T, U, V CASE

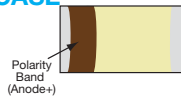

LOW PROFILE CASE DIMENSIONS: millimeters (inches)

Code	EIA Code	EIA Metric	L+0.20 (0.008) -0.00 (0.000)	W+0.15 (0.006) -0.00 (0.000)	H max	Termination Spacing(S)	Minimum Termination Length (Lt)
H	0805	2012-10	2.00 (0.079)	1.35 (0.053)	1.00 (0.039)	0.70 (0.028) min	0.15 (0.006)
I	1206	3216-05	3.20±0.20 (0.126±0.008)	1.60±0.20 (0.063±0.008)	0.50 (0.020)	1.80 (0.071) min.	0.15 (0.006)
J	0603	1608-08	1.60 (0.063)	0.85 (0.033)	0.75 (0.030)	0.55 (0.022) min	0.15 (0.006)
T	1210	3528-12	3.50 ± 0.20 (0.138 ± 0.008)	2.80 ^{+0.20} _{-0.10} (0.110 ^{+0.008} _{-0.004})	1.20 (0.047)	2.00 (0.079) min	0.15 (0.006)
U	0805	2012-06	2.00 (0.079)	1.35 (0.053)	0.60 (0.024)	0.70 (0.028) min	0.15 (0.006)
V	1206	3216-08	3.20 ± 0.20 (0.126 ± 0.008)	1.60 ± 0.20 (0.063 ± 0.008)	0.75 (0.030)	1.80 (0.071) min	0.15 (0.006)

HOW TO ORDER

TAC Type TACmicrochip®	L Case Size See table above	226 Capacitance Code pF code: 1st two digits represent significant figures, 3rd digit represents multiplier (number of zeros to follow)	* Tolerance K=±10% M=±20%	004 Rated DC Voltage 002=2Vdc 003=3Vdc 004=4Vdc 006=6.3Vdc 010=10Vdc 016=16Vdc 020=20Vdc 025=25Vdc	R Packaging R, P = 7" Standard Tin Termination Plastic Tape X, Q = 4 1/4" Standard Tin Termination Plastic Tape A, M = 7" Gold Termination Plastic Tape F, N = 4 1/4" Gold Termination Plastic Tape	TA Alternative characters may be used for special requirements
-------------------------------------	--	--	---	--	---	--

TECHNICAL SPECIFICATIONS

Technical Data:	All technical data relate to an ambient temperature of +25°C								
Capacitance Range:	0.10 µF to 150 µF								
Capacitance Tolerance:	±10%; ±20%								
Leakage Current DCL:	0.01CV or 0.5µA whichever is the greater								
Rated Voltage (V _R)	≤ +85°C:	2	3	4	6.3	10	16	20	25
Category Voltage (V _C)	≤ +125°C:	1.3	2	2.7	4	7	10	13	17
Surge Voltage (V _S)	≤ +85°C:	2.7	3.9	5.2	8	13	20	26	32
Surge Voltage (V _S)	≤ +125°C:	1.7	2.6	3.2	5	8	12	16	20
Temperature Range:	-55°C to +125°C								
Reliability:	1% per 1000 hours at 85°C, V _R with 0.1Ω/V series impedance, 60% confidence level								
Termination Finish:	Tin Plating over Nickel (standard), Gold Plating over Nickel option available upon request								

Standard and Low Profile Tantalum Microchip Capacitors

STANDARD MICROCHIP CAPACITANCE AND RATED VOLTAGE RANGE (LETTER DENOTES CASE SIZE)

Capacitance		Voltage Rating DC (V _R) at 85°C							
µF	Code	2.0V	3.0V	4.0V	6.3V	10V	16V	20V	25V
0.10	104						K		
0.15	154					K	K		
0.22	224					K	K	K	
0.33	334					K	K		
0.47	474					K/L	L		
0.68	684					K/L	L		
1.0	105				K/L	K/L/R	L		R
1.5	155			L	L	L	L		
2.2	225		K/L	L	K/L	L	L		
3.3	335	K/L	K/L	L	L	L/R		R	
4.7	475	K/L	K/L	L	L	L/R		R	
6.8	685	K/L	L	L	L/R	L/R		R	
10	106	K/L	L	L/R	L/R	L/R	R		
15	156		R	L/R	L/R	R			
22	226	R	L/R	L/R	R	R			
33	336	R	R	R	R	A/R			
47	476	R	R	R	A/R	B			
68	686	R	A/R	A					
100	107		A/R	A/R	A				
150	157	A							
220	227								

LOW PROFILE MICROCHIP CAPACITANCE AND RATED VOLTAGE RANGE (LETTER DENOTES CASE SIZE)

Capacitance		Voltage Rating DC (V _R) at 85°C					
µF	Code	2.0V	3.0V	4.0V	6.3V	10V	16V
1.0	105						U
1.5	155						
2.2	225					U	
3.3	335				U		
4.7	475			U			
6.8	685						
10	106	U		J	I	H/V	
15	156				H	V	
22	226				H		
33	336			H			
47	476		H			T	
68	686					T	
100	107					T	

Released ratings

Engineering samples - please contact AVX

*Ratings under development – subject to change

Note: Voltage ratings are minimum values. AVX reserves the right to supply higher voltage ratings in the same case size, to the same reliability standards.

Standard and Low Profile Tantalum Microchip Capacitors

RATINGS & PART NUMBER REFERENCE

AVX Part No.	Case Size	Capacitance (µF)	Rated Voltage (V)	Rated Temperature (°C)	Category Voltage (V)	Category Temperature (°C)	DCL Max. (µA)	DF Max. (%)	ESR Max. @ 100kHz (Ω)	MSL	100kHz RMS Current (mA)			Product Category
											25°C	85°C	125°C	
2 Volt @ 85°C														
TACK335*002#TA	K	3.3	2	85	1.3	125	0.5	8	15	1	32	28	13	3
TACL335*002#TA	L	3.3	2	85	1.3	125	0.5	6	7.5	1	58	52	23	2
TACK475*002#TA	K	4.7	2	85	1.3	125	0.5	12	15	1	32	28	13	3
TACL475*002#TA	L	4.7	2	85	1.3	125	0.5	6	7.5	1	58	52	23	1
TACK685*002#TA	K	6.8	2	85	1.3	125	0.5	20	15	1	32	28	13	3
TACL685*002#TA	L	6.8	2	85	1.3	125	0.5	6	7.5	1	58	52	23	2
TACK106*002#TA	K	10	2	85	1.3	125	0.5	15	15	1	32	28	13	3
TACL106*002#TA	L	10	2	85	1.3	125	0.5	10	7.5	1	58	52	23	3
TACU106*002#TA	U	10	2	85	1.3	125	0.5	8	5	1	84	75	33	1
TACR226*002#TA	R	22	2	85	1.3	125	0.5	8	5	1	95	85	38	1
TACR336*002#TA	R	33	2	85	1.3	125	0.7	10	5	1	95	85	38	2
TACR476*002#TA	R	47	2	85	1.3	125	0.9	10	5	1	95	85	38	2
TACR686*002#TA	R	68	2	85	1.3	125	1.4	14	5	1	95	85	38	2
TACA157*002#TA	A	150	2	85	1.3	125	3	20	1	1	200	180	80	2
3 Volt @ 85°C														
TACK225*003#TA	K	2.2	3	85	2	125	0.5	6	15	1	32	28	13	2
TACL225*003#TA	L	2.2	3	85	2	125	0.5	6	7.5	1	58	52	23	1
TACK335*003#TA	K	3.3	3	85	2	125	0.5	8	15	1	32	28	13	3
TACL335*003#TA	L	3.3	3	85	2	125	0.5	6	7.5	1	58	52	23	2
TACK475*003#TA	K	4.7	3	85	2	125	0.5	12	15	1	32	28	13	3
TACL475*003#TA	L	4.7	3	85	2	125	0.5	6	7.5	1	58	52	23	1
TACL685*003#TA	L	6.8	3	85	2	125	0.5	6	7.5	1	58	52	23	2
TACL106*003#TA	L	10	3	85	2	125	0.5	10	7.5	1	58	52	23	3
TACR156*003#TA	R	15	3	85	2	125	0.5	8	5	1	95	85	38	1
TACL226*003#TA	L	22	3	85	2	125	0.7	20	7.5	1	58	52	23	3
TACR226*003#TA	R	22	3	85	2	125	0.7	8	5	1	95	85	38	1
TACR336*003#TA	R	33	3	85	2	125	1	10	5	1	95	85	38	2
TACH476*003#TA	H	47	3	85	2	125	1.4	20	5	1	89	80	36	3
TACR476*003#TA	R	47	3	85	2	125	1.5	10	5	1	95	85	38	2
TACA686*003#TA	A	68	3	85	2	125	2	15	2	1	141	127	57	1
TACR686*003#TA	R	68	3	85	2	125	2	14	5	1	95	85	38	3
TACA107*003#TA	A	100	3	85	2	125	3	15	1	1	200	180	80	2
TACR107*003#TA	R	100	3	85	2	125	3	30	5	1	95	85	38	3
4 Volt @ 85°C														
TACL155*004#TA	L	1.5	4	85	2.7	125	0.5	6	7.5	1	58	52	23	1
TACL225*004#TA	L	2.2	4	85	2.7	125	0.5	6	7.5	1	58	52	23	1
TACL335*004#TA	L	3.3	4	85	2.7	125	0.5	6	7.5	1	58	52	23	2
TACL475*004#TA	L	4.7	4	85	2.7	125	0.5	6	7.5	1	58	52	23	1
TACU475*004#TA	U	4.7	4	85	2.7	125	0.5	8	5	1	84	75	33	1
TACL685*004#TA	L	6.8	4	85	2.7	125	0.5	8	7.5	1	58	52	23	2
TACJ106*004#TA	J	10	4	85	2.7	125	0.5	20	7.5	1	52	46	21	3
TACL106*004#TA	L	10	4	85	2.7	125	0.5	10	7.5	1	58	52	23	2
TACR106*004#TA	R	10	4	85	2.7	125	0.5	8	5	1	95	85	38	1
TACL156*004#TA	L	15	4	85	2.7	125	0.6	20	7.5	1	58	52	23	3
TACR156*004#TA	R	15	4	85	2.7	125	0.6	8	5	1	95	85	38	1
TACL226*004#TA	L	22	4	85	2.7	125	0.9	20	7.5	1	58	52	23	3
TACR226*004#TA	R	22	4	85	2.7	125	0.9	8	5	1	95	85	38	1
TACH336*004#TA	H	33	4	85	2.7	125	1.3	14	5	1	89	80	36	2
TACR336*004#TA	R	33	4	85	2.7	125	1.3	10	5	1	95	85	38	2
TACR476*004#TA	R	47	4	85	2.7	125	1.9	14	5	1	95	85	38	3
TACA686*004#TA	A	68	4	85	2.7	125	2.7	15	1	1	200	180	80	1
TACA107*004#TA	A	100	4	85	2.7	125	4	20	1	1	200	180	80	2
TACR107*004#TA	R	100	4	85	2.7	125	4	30	5	1	95	85	38	3
6.3 Volt @ 85°C														
TACK105*006#TA	K	1	6.3	85	4	125	0.5	6	15	1	32	28	13	2
TACL105*006#TA	L	1	6.3	85	4	125	0.5	6	7.5	1	58	52	23	1
TACL155*006#TA	L	1.5	6.3	85	4	125	0.5	6	7.5	1	58	52	23	1
TACK225*006#TA	K	2.2	6.3	85	4	125	0.5	8	15	1	32	28	13	3
TACL225*006#TA	L	2.2	6.3	85	4	125	0.5	6	7.5	1	58	52	23	1
TACL335*006#TA	L	3.3	6.3	85	4	125	0.5	6	7.5	1	58	52	23	2
TACU335*006#TA	U	3.3	6.3	85	4	125	0.5	8	5	1	84	75	33	1
TACL475*006#TA	L	4.7	6.3	85	4	125	0.5	8	7.5	1	58	52	23	2
TACL685*006#TA	L	6.8	6.3	85	4	125	0.5	10	7.5	1	58	52	23	2
TACR685*006#TA	R	6.8	6.3	85	4	125	0.5	8	5	1	95	85	38	1
TACL106*006#TA	L	10	6.3	85	4	125	0.6	20	5	1	84	75	33	2
TACL106*006#TA	L	10	6.3	85	4	125	0.6	10	6	1	65	58	26	2
TACR106*006#TA	R	10	6.3	85	4	125	0.6	8	5	1	95	85	38	1
TACH156*006#TA	H	15	6.3	85	4	125	0.9	8	5	1	89	80	36	3
TACL156*006#TA	L	15	6.3	85	4	125	0.9	20	7.5	1	58	52	23	3
TACR156*006#TA	R	15	6.3	85	4	125	0.9	8	5	1	95	85	38	1

RATINGS & PART NUMBER REFERENCE

AVX Part No.	Case Size	Capacitance (µF)	Rated Voltage (V)	Rated Temperature (°C)	Category Voltage (V)	Category Temperature (°C)	DCL Max. (µA)	DF Max. (%)	ESR Max. @ 100kHz (Ω)	MSL	100kHz RMS Current (mA)			Product Category
											25°C	85°C	125°C	
TACH226*006#TA	H	22	6.3	85	4	125	1.4	10	5	1	89	80	36	2
TACR226*006#TA	R	22	6.3	85	4	125	1.4	10	5	1	95	85	38	1
TACR336*006#TA	R	33	6.3	85	4	125	2.1	12	5	1	95	85	38	2
TACA476*006#TA	A	47	6.3	85	4	125	3	15	1	1	200	180	80	1
TACR476*006#TA	R	47	6.3	85	4	125	3	20	5	1	95	85	38	3
TACT686*006#TA	T	68	6.3	85	4	125	4.3	15	1	1	200	180	80	2
TACA107*006#TA	A	100	6.3	85	4	125	6.3	20	1	1	200	180	80	2
TACT107*006#TA	T	100	6.3	85	4	125	6.3	12	1	1	200	180	80	2
10 Volt @ 85°C														
TACK154*010#TA	K	0.15	10	85	7	125	0.5	6	40	1	19	17	8	1
TACK224*010#TA	K	0.22	10	85	7	125	0.5	6	30	1	22	20	9	1
TACK334*010#TA	K	0.33	10	85	7	125	0.5	6	20	1	27	25	11	1
TACK474*010#TA	K	0.47	10	85	7	125	0.5	6	15	1	32	28	13	1
TACL474*010#TA	L	0.47	10	85	7	125	0.5	6	7.5	1	58	52	23	1
TACK684*010#TA	K	0.68	10	85	7	125	0.5	8	15	1	32	28	13	2
TACL684*010#TA	L	0.68	10	85	7	125	0.5	6	7.5	1	58	52	23	1
TACK105*010#TA	K	1	10	85	7	125	0.5	6	15	1	32	28	13	2
TACL105*010#TA	L	1	10	85	7	125	0.5	6	7.5	1	58	52	23	1
TACR105*010#TA	R	1	10	85	7	125	0.5	6	7	1	80	72	32	1
TACL155*010#TA	L	1.5	10	85	7	125	0.5	6	7.5	1	58	52	23	1
TACL225*010#TA	L	2.2	10	85	7	125	0.5	6	7.5	1	58	52	23	1
TACU225*010#TA	U	2.2	10	85	7	125	0.5	8	5	1	84	75	33	1
TACL335*010#TA	L	3.3	10	85	7	125	0.5	8	7.5	1	58	52	23	2
TACR335*010#TA	R	3.3	10	85	7	125	0.5	8	5	1	95	85	38	1
TACL475*010#TA	L	4.7	10	85	7	125	0.5	10	6	1	65	58	26	2
TACR475*010#TA	R	4.7	10	85	7	125	0.5	8	6	1	87	78	35	1
TACL685*010#TA	L	6.8	10	85	7	125	0.7	20	7.5	1	58	52	23	3
TACR685*010#TA	R	6.8	10	85	7	125	0.7	8	5	1	95	85	38	1
TACH106*010#TA	H	10	10	85	7	125	1.0	8	5	1	89	80	36	2
TACL106*010#TA	L	10	10	85	7	125	1	20	7.5	1	58	52	23	3
TACR106*010#TA	R	10	10	85	7	125	1	8	5	1	95	85	38	1
TACV106*010#TA	V	10	10	85	7	125	1.0	10	2	1	132	119	53	2
TACR156*010#TA	R	15	10	85	7	125	1.5	10	5	1	95	85	38	1
TACV156*010#TA	V	15	10	85	7	125	1.5	10	2	1	132	119	53	2
TACR226*010#TA	R	22	10	85	7	125	2.2	14	5	1	95	85	38	2
TACA336*010#TA	A	33	10	85	7	125	3.3	12	1	1	200	180	80	1
TACR336*010#TA	R	33	10	85	7	125	3.3	20	5	1	95	85	38	3
TACB476*010#TA	B	47	10	85	7	125	4.7	15	1	1	200	180	80	1
TACT476*010#TA	T	47	10	85	7	125	4.7	12	1	1	200	180	80	1
16 Volt @ 85°C														
TACK104*016#TA	K	0.1	16	85	10	125	0.5	6	40	1	19	17	8	1
TACK154*016#TA	K	0.15	16	85	10	125	0.5	6	30	1	22	20	9	1
TACK224*016#TA	K	0.22	16	85	10	125	0.5	6	20	1	27	25	11	1
TACK334*016#TA	K	0.33	16	85	10	125	0.5	6	20	1	27	25	11	1
TACK474*016#TA	L	0.47	16	85	10	125	0.5	6	7.5	1	58	52	23	1
TACL684*016#TA	L	0.68	16	85	10	125	0.5	6	7.5	1	58	52	23	1
TACL105*016#TA	L	1	16	85	10	125	0.5	6	7.5	1	58	52	23	1
TACU105*016#TA	U	1	16	85	10	125	0.5	8	5	1	84	75	33	1
TACL225*016#TA	L	2.2	16	85	10	125	0.5	10	7.5	1	58	52	23	1
TACR106*016#TA	R	10	16	85	10	125	1.6	10	5	1	95	85	38	2
20 Volt @ 85°C														
TACK224*020#TA	K	0.22	20	85	13	125	0.5	6	20	1	27	25	11	1
TACR335*020#TA	R	3.3	20	85	13	125	0.7	8	5	1	95	85	38	1
TACR475*020#TA	R	4.7	20	85	13	125	0.9	8	5	1	95	85	38	1
25 Volt @ 85°C														
TACR105*025#TA	R	1	25	85	17	125	0.5	8	5	1	95	85	38	1

Moisture Sensitivity Level (MSL) is defined according to J-STD-020.

All technical data relates to an ambient temperature of +25°C. Capacitance and DF are measured at 120Hz, 0.5V RMS with a maximum DC bias of 2.2 volts.

DCL is measured at rated voltage after 5 minutes.

For typical weight and composition see page 222.

NOTE: AVX reserves the right to supply a higher voltage ratings or tighter tolerance part in the same case size, to the same reliability standards.

QUALIFICATION TABLE – CATEGORY 1

TEST	TAC series (Temperature range -55°C to +125°C)										
	Condition			Characteristics							
Endurance	Apply rated voltage (UR) at 85±2°C and / or category voltage (Uc) at 105±2°C for 2000 +48/-0 hours through a circuit impedance of ≤0.1Ω/V. Stabilize at room temperature for 1-2 hours before measuring.			Visual examination	no visible damage						
				DCL	1.25 x initial limit						
				ΔC/C	within ±10% of initial value						
				DF	1.5 x initial limit						
				ESR	1.5 x initial limit						
Humidity	Store at 40±2°C and (90 - 95)% relative humidity for 1344+48/-0 hours, with no applied voltage. Stabilize at room temperature and humidity for 1-2 hours before measuring.			Visual examination	no visible damage						
				DCL	initial limit						
				ΔC/C	within ±5% of initial value						
				DF	1.2 x initial limit						
				ESR	1.2 x initial limit						
Temperature Stability	Step	Temperature°C	Duration(min)		+20°C	-55°C	+20°C	+85°C	+125°C	+20°C	
	1	+20±2	15	DCL	IL*	n/a	IL*	10 x IL*	12.5 x IL*	IL*	
	2	-55+0/-3	15		ΔC/C	n/a	+0/-10%	±5%	+10/-0%	+15/-0%	±5%
	3	+20±2	15	DF		IL*	1.5 x IL*	IL*	1.5 x IL*	2 x IL*	IL*
	4	+85+3/-0	15		ESR	IL*	1.25 x IL*	IL*	1.25 x IL*	2 x IL*	IL*
	5	+125+3/-0	15								
	6	+20±2	15								
Surge Voltage	Apply 1.3x category voltage (Uc) at 85°C +3/-0°C for 1,000 cycles of duration 6 mins. (30 secs. charge, 5 min. 30 sec. discharge) through a charge / discharge resistance of 1000±100Ω			Visual examination	no visible damage						
				DCL	initial limit						
				ΔC/C	within ±10% of initial value						
				DF	initial limit						
				ESR	initial limit						

*Initial Limit

QUALIFICATION TABLE – CATEGORY 2

TEST	TAC series (Temperature range -55°C to +125°C)										
	Condition			Characteristics							
Endurance	Apply rated voltage (UR) at 85±2°C and / or category voltage (Uc) at 105±2°C for 2000 +48/-0 hours through a circuit impedance of ≤0.1Ω/V. Stabilize at room temperature for 1-2 hours before measuring.			Visual examination	no visible damage						
				DCL	1.25 x initial limit						
				ΔC/C	within ±15% of initial value						
				DF	1.5 x initial limit						
				ESR	1.5 x initial limit						
Humidity	Store at 40±2°C and (90 - 95)% relative humidity for 1344+48/-0 hours, with no applied voltage. Stabilize at room temperature and humidity for 1-2 hours before measuring.			Visual examination	no visible damage						
				DCL	initial limit						
				ΔC/C	within ±10% of initial value						
				DF	1.2 x initial limit						
				ESR	1.2 x initial limit						
Temperature Stability	Step	Temperature°C	Duration(min)		+20°C	-55°C	+20°C	+85°C	+125°C	+20°C	
	1	+20±2	15	DCL	IL*	n/a	IL*	10 x IL*	12.5 x IL*	IL*	
	2	-55+0/-3	15		ΔC/C	n/a	+0/-15%	±5%	+15/-0%	+20/-0%	±5%
	3	+20±2	15	DF		IL*	1.5 x IL*	IL*	1.5 x IL*	2 x IL*	IL*
	4	+85+3/-0	15		ESR	IL*	1.25 x IL*	IL*	1.25 x IL*	2 x IL*	IL*
	5	+125+3/-0	15								
	6	+20±2	15								
Surge Voltage	Apply 1.3x category voltage (Uc) at 85°C +3/-0°C for 1,000 cycles of duration 6 mins. (30 secs. charge, 5 min. 30 sec. discharge) through a charge / discharge resistance of 1000±100Ω			Visual examination	no visible damage						
				DCL	1.5 x initial limit						
				ΔC/C	within ±15% of initial value						
				DF	1.5 x initial limit						
				ESR	1.5 x initial limit						

*Initial Limit

QUALIFICATION TABLE – CATEGORY 3

TEST	TAC series (Temperature range -55°C to +125°C)										
	Condition			Characteristics							
Endurance	Apply rated voltage (UR) at 85±2°C and/or category voltage (Uc) at 105±2°C for 2000 +48/-0 hours through a circuit impedance of ≤0.1Ω/V. Stabilize at room temperature for 1-2 hours before measuring.			Visual examination	no visible damage						
				DCL	1.25 x initial limit						
				ΔC/C	within ±30% of initial value						
				DF	1.5 x initial limit						
				ESR	1.5 x initial limit						
Humidity	Store at 40±2°C and (90 - 95)% relative humidity for 1344+48/-0 hours, with no applied voltage. Stabilize at room temperature and humidity for 1-2 hours before measuring.			Visual examination	no visible damage						
				DCL	2 x initial limit						
				ΔC/C	within ±30% of initial value						
				DF	1.5 x initial limit						
				ESR	1.25 x initial limit						
Temperature Stability	Step	Temperature°C	Duration(min)		+20°C	-55°C	+20°C	+85°C	+125°C	+20°C	
	1	+20±2	15	DCL	IL*	n/a	IL*	10 x IL*	12.5 x IL*	IL*	
	2	-55+0/-3	15		ΔC/C	n/a	+0/-25%	±5%	+20/-0%	+25/-0%	±20%
	3	+20±2	15	DF		IL*	1.5 x IL*	IL*	1.5 x IL*	2 x IL*	1.5 x IL*
	4	+85+3/-0	15		ESR	IL*	1.25 x IL*	IL*	1.25 x IL*	2 x IL*	1.5 x IL*
	5	+125+3/-0	15								
	6	+20±2	15								
Surge Voltage	Apply 1.3x category voltage (Uc) at 85°C +3/-0°C for 1,000 cycles of duration 6 mins. (30 secs. charge, 5 min. 30 sec. discharge) through a charge / discharge resistance of 1000±100Ω			Visual examination	no visible damage						
				DCL	2 x initial limit						
				ΔC/C	within ±30% of initial value						
				DF	2 x initial limit						
				ESR	2 x initial limit						

*Initial Limit

AVX SOLID ELECTROLYTIC CAPACITOR ROADMAP

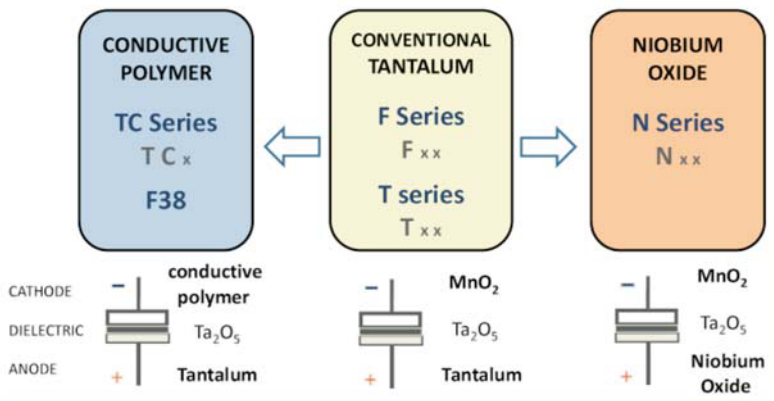

FIVE CAPACITOR CONSTRUCTION STYLES

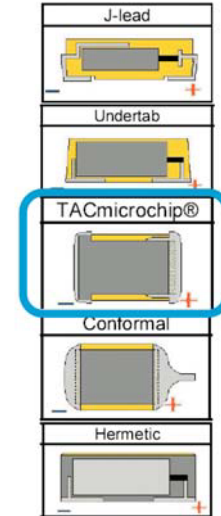

SERIES LINE UP: CONVENTIONAL SMD MnO₂

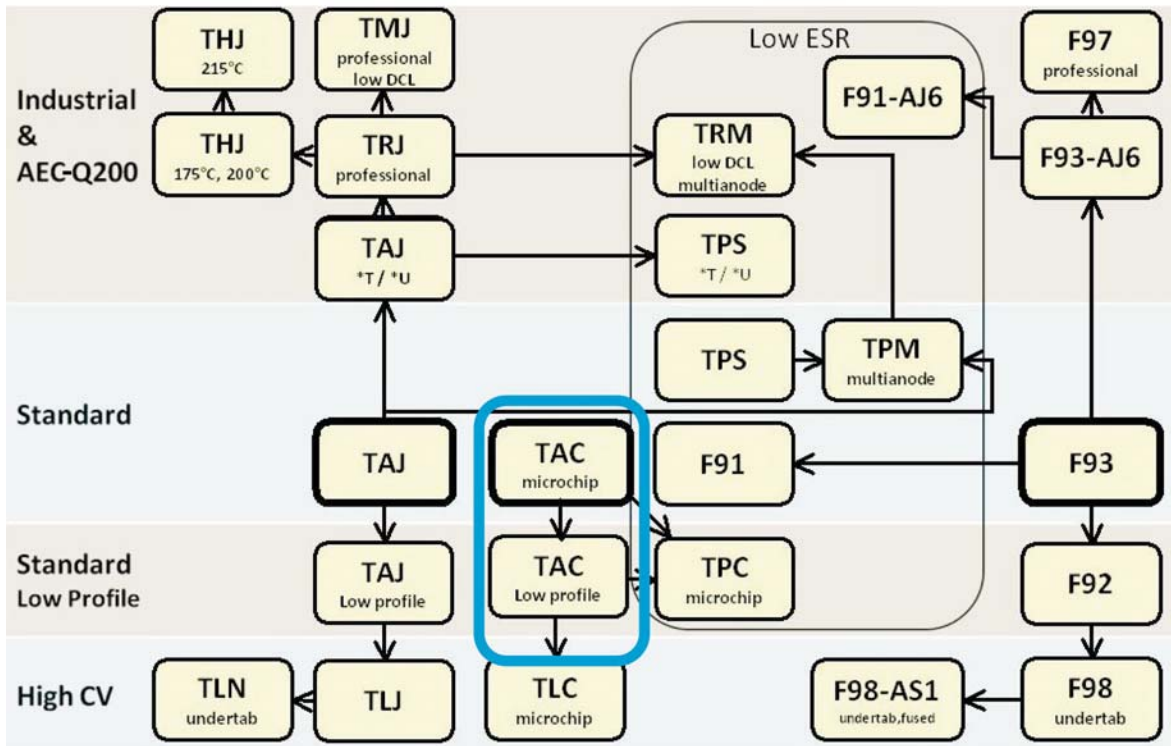

TLC Series



Tantalum Solid Electrolytic Chip Capacitors Consumer Series

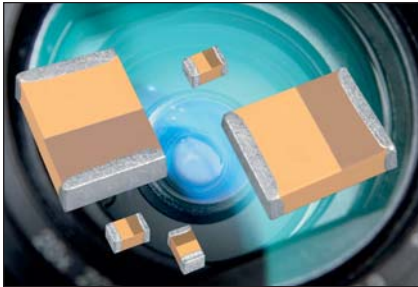

FEATURES

- High capacitance vs. voltage ratio
- Super high volumetric efficiency
- CV range: 0.47-220 μ F / 2-35V
- 12 case sizes available
- Consumer applications (portable handheld electronics, cellular phones, digital equipments etc.)



APPLICATIONS

- Consumer portable applications with space limitations

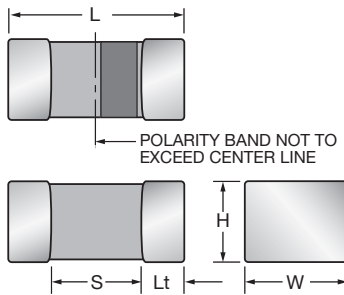

CASE DIMENSIONS: millimeters (inches)

Code	EIA Code	EIA Metric	L+0.20 (0.008) -0.00 (0.000)	W+0.15 (0.006) -0.00 (0.000)	H+0.15 (0.006) -0.00 (0.000)	Termination Spacing(S)	Minimum Termination Length (Lt)
A	1206	3216-18	3.20 \pm 0.20 (0.126 \pm 0.008)	1.60 \pm 0.20 (0.063 \pm 0.008)	1.60 \pm 0.20 (0.063 \pm 0.008)	1.80 (0.071) min	0.15 (0.006)
D	1206	3216-06	3.20 \pm 0.20 (0.126 \pm 0.008)	1.60 \pm 0.20 (0.063 \pm 0.008)	0.60 (0.024) max	1.80 (0.071) min	0.15 (0.006)
E**	0201	0603-03	0.60 \pm 0.12 (0.024 \pm 0.005)	0.33 \pm 0.02 (0.013 \pm 0.001)	0.33 \pm 0.02 (0.013 \pm 0.001)	0.20 (0.008) min	0.10 (0.004)
H	0805	2012-10	2.00 (0.079)	1.35 (0.053)	1.00 (0.039) max	0.70 (0.028) min	0.15 (0.006)
J	0603	1608-08	1.60 (0.063)	0.85 (0.033)	0.75 (0.030) max	0.55 (0.022) min	0.15 (0.006)
K	0402	1005-07	1.00 (0.039)	0.50 $^{+0.20}_{-0.00}$ (0.020 $^{+0.008}_{-0.000}$)	0.50 $^{+0.20}_{-0.00}$ (0.020 $^{+0.008}_{-0.000}$)	0.40 (0.016) min	0.10 (0.004)
L	0603	1608-10	1.60 (0.063)	0.85 (0.033)	0.85 (0.033)	0.55 (0.022) min	0.15 (0.006)
M	0803	2008-10	2.00 (0.079)	0.85 (0.033)	0.85 (0.033)	0.70 (0.028) min	0.15 (0.006)
R	0805	2012-15	2.00 (0.079)	1.35 (0.053)	1.35 (0.053)	0.70 (0.028) min	0.15 (0.006)
T	1210	3528-12	3.50 \pm 0.20 (0.138 \pm 0.008)	2.80 $^{+0.20}_{-0.10}$ (0.110 $^{+0.008}_{-0.004}$)	1.20 (0.047) max	2.00 (0.079) min	0.15 (0.006)
U	0805	2012-06	2.00 (0.079)	1.35 (0.053)	0.60 (0.024) max	0.70 (0.028) min	0.15 (0.006)
V	1206	3216-08	3.20 \pm 0.20 (0.126 \pm 0.008)	1.60 \pm 0.20 (0.063 \pm 0.008)	0.75 (0.030) max	1.80 (0.071) min	0.15 (0.006)
Z	0602	1605-07	1.60 (0.063)	0.50 $^{+0.20}_{-0.00}$ (0.020 $^{+0.008}_{-0.000}$)	0.50 $^{+0.20}_{-0.00}$ (0.020 $^{+0.008}_{-0.000}$)	0.55 (0.022) min	0.15 (0.006)

**Please contact manufacturer, availability upon request

Under development

MARKING

A, D, H, J, K, L, M, R, T,
U, V, Z CASE

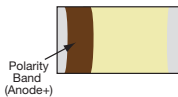

E CASE

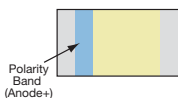

HOW TO ORDER

TLC

↓

Type

L

↓

Case Size
See table above

226

↓

Capacitance Code
pF code: 1st two digits represent significant figures, 3rd digit represents multiplier (number of zeros to follow)

M

↓

Tolerance
M=±20%

006

↓

Rated DC Voltage
002=2Vdc
003=3Vdc
004=4Vdc
006=6.3Vdc
008=8Vdc
010=10Vdc
016=16Vdc
020=20Vdc
025=25Vdc
035=35Vdc

R

↓

Packaging
R, P = 7" Standard Tin Termination Plastic Tape
X, Q = 4 1/4" Standard Tin Termination Plastic Tape
A, M = 7" Gold Termination Plastic Tape
F, N = 4 1/4" Gold Termination Plastic Tape
H = Chip Tray (waffle) Only case E

TA

↓

Standard Suffix
OR
4000
↓
ESR in m Ω

TLC Series



Tantalum Solid Electrolytic Chip Capacitors Consumer Series

TECHNICAL SPECIFICATIONS

Technical Data:	All technical data relate to an ambient temperature of +25°C										
Capacitance Range:	0.47 μ F to 220 μ F										
Capacitance Tolerance:	\pm 20%										
Rated Voltage (V_R)	-55°C \leq +40°C:	2	3	4	6.3	8	10	16	20	25	35
Category Voltage (V_C)	at 85°C:	1	1.5	2	3.2	4	5	8	10	12.5	17.5
Category Voltage (V_C)	at 125°C:	0.4	0.6	0.8	1.3	1.6	2	3.2	4	5	7
Temperature Range:	-55°C to +125°C with category voltage										
Reliability:	0.2% per 1000 hours at 85°C, 0.5x V_R with 0.1 Ω/V series impedance with 60% confidence level										

CAPACITANCE AND RATED VOLTAGE RANGE (LETTER DENOTES CASE SIZE)

Capacitance		Voltage Rating DC (V_R) to 40°C									
μ F	Code	2.0V	3.0V	4.0V	6.3V	8V	10V	16V	20V	25V	35V
0.47	474				E**			K			
1.0	105				E**			K		L	R
2.2	225						K		H	R	
3.3	335							L			
4.7	475			K	K/U		J				
6.8	685		K	K			U				
10	106		K	J/K/Z	J/K/Z		U	V	R		
15	156	K	K*	K			H/L				
22	226	J	J	K*/U	L/U		L/M				
33	336			L/U	H/L/L(4000)/U/V	L	H				
47	476	L	L/R	H/L	H/L/R/V	D	H/R				
68	686			R	R		R*				
100	107			I*/R	D*/I*/R/T		R*/T				
150	157			R*	R*		A*				
220	227	R*		R*/T							

Available Ratings, (ESR ratings in mOhms in brackets)

Engineering samples - please contact manufacturer

*Codes under development - subject to change.

**Please contact manufacturer, availability upon request

Note: Voltage ratings are minimum values. AVX reserves the right to supply higher ratings in the same case size, to the same reliability standards.

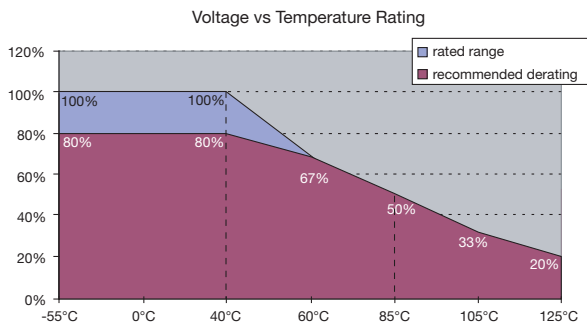

TLC Series



Tantalum Solid Electrolytic Chip Capacitors Consumer Series

RATINGS & PART NUMBER REFERENCE

AVX Part No.	Case Size	Capacitance (µF)	Rated Voltage (V)	Rated Temperature (°C)	Category Voltage (V)	Category Temperature (°C)	DCL Max. (µA)	ESR Max. @ 100kHz (Ω)	MSL	100kHz RMS Current (mA)		
										25°C	85°C	125°C
2 Volt @ 40°C												
TLCK156M002#TA	K	15	2	40	0.4	125	0.5	15	3	32	28	13
TLCJ226M002#TA	J	22	2	40	0.4	125	0.5	7.5	3	52	46	21
TLCL476M002#TA	L	47	2	40	0.4	125	0.9	7.5	3	58	52	23
3 Volt @ 40°C												
TLCK685M003#TA	K	6.8	3	40	0.6	125	0.5	15	3	32	28	13
TLCK106M003#TA	K	10	3	40	0.6	125	0.5	15	3	32	28	13
TLCJ226M003#TA	J	22	3	40	0.6	125	0.7	7.5	3	52	46	21
TLCL476M003#TA	L	47	3	40	0.6	125	1.4	7.5	3	58	52	23
TLCR476M003#TA	R	47	3	40	0.6	125	3.0	7.5	3	77	70	31
4 Volt @ 40°C												
TLCK475M004#TA	K	4.7	4	40	0.8	125	0.5	15	3	32	28	13
TLCK685M004#TA	K	6.8	4	40	0.8	125	0.5	15	3	32	28	13
TLCJ106M004#TA	J	10	4	40	0.8	125	0.5	7.5	3	52	46	21
TLCK106M004#TA	K	10	4	40	0.8	125	0.5	15	3	32	28	13
TLCZ106M004#TA	Z	10	4	40	0.8	125	0.5	15	3	37	33	15
TLCK156M004#TA	K	15	4	40	0.8	125	3.0	15	3	32	28	13
TLCU226M004#TA	U	22	4	40	0.8	125	0.9	12	3	54	49	22
TLCL336M004#TA	L	33	4	40	0.8	125	1.3	7.5	3	58	52	23
TLCU336M004#TA	U	33	4	40	0.8	125	2.6	9	3	62	56	25
TLCH476M004#TA	H	47	4	40	0.8	125	1.9	5	3	89	80	36
TLCL476M004#TA	L	47	4	40	0.8	125	1.9	7.5	3	58	52	23
TLCR686M004#TA	R	68	4	40	0.8	125	2.7	5	3	95	85	38
TLCR107M004#TA	R	100	4	40	0.8	125	4.0	5	3	95	85	38
TLCT227M004#TA	T	220	4	40	0.8	125	8.8	1	3	200	180	80
6.3 Volt @ 40°C												
TLCE474M006HTA**	E	0.47	6.3	40	1.3	125	1.0	60	3	13	12	5
TLCE105M006HTA**	E	1	6.3	40	1.3	125	1.0	60	3	13	12	5
TLCK475M006#TA	K	4.7	6.3	40	1.3	125	0.5	15	3	32	28	13
TLCU475M006#TA	U	4.7	6.3	40	1.3	125	0.5	5	3	84	75	33
TLCJ106M006#TA	J	10	6.3	40	1.3	125	0.6	7.5	3	52	46	21
TLCK106M006#TA	K	10	6.3	40	1.3	125	3.1	15	3	32	28	13
TLCZ106M006#TA	Z	10	6.3	40	1.3	125	0.6	15	3	37	33	15
TLCL226M006#TA	L	22	6.3	40	1.3	125	1.4	7.5	3	58	52	23
TLCU226M006#TA	U	22	6.3	40	1.3	125	2.8	12	3	54	49	22
TLCH336M006#TA	H	33	6.3	40	1.3	125	2.0	5	3	89	80	36
TLCL336M006#TA	L	33	6.3	40	1.3	125	2.1	7.5	3	58	52	23
TLCL336M006#4000	L	33	6.3	40	1.3	125	2.1	4	3	79	71	32
TLCU336M006#TA	U	33	6.3	40	1.3	125	10.4	7.5	3	68	61	27
TLCV336M006#TA	V	33	6.3	40	1.3	125	4.2	5	3	84	75	33
TLCH476M006#TA	H	47	6.3	40	1.3	125	3.0	5	3	89	80	36
TLCL476M006#TA	L	47	6.3	40	1.3	125	29.6	10	3	50	45	20
TLCR476M006#TA	R	47	6.3	40	1.3	125	6.0	5	3	95	85	38
TLCV476M006#TA	V	47	6.3	40	1.3	125	6.0	15	3	48	43	19
TLCR686M006#TA	R	68	6.3	40	1.3	125	4.3	5	3	95	85	38
TLCR107M006#TA	R	100	6.3	40	1.3	125	6.0	5	3	95	85	38
TLCT107M006#TA	T	100	6.3	40	1.3	125	31.5	15	3	52	46	21
8 Volt @ 40°C												
TLCL336M008#TA	L	33	8	40	1.6	125	26.4	10	3	50	45	20
TLCD476M008#TA	D	47	8	40	1.6	125	18.8	7	3	71	64	28
10 Volt @ 40°C												
TLCK225M010#TA	K	2.2	10	40	2	125	0.5	15	3	32	28	13
TLCJ475M010#TA	J	4.7	10	40	2	125	0.5	10	3	45	40	18
TLCU685M010#TA	U	6.8	10	40	2	125	0.7	5	3	84	75	33
TLCU106M010#TA	U	10	10	40	2	125	1.0	5	3	84	75	33
TLCH156M010#TA	H	15	10	40	2	125	1.5	5	3	58	52	23
TLCL156M010#TA	L	15	10	40	2	125	1.5	7.5	3	89	80	36
TLCL226M010#TA	L	22	10	40	2	125	11	10	3	50	45	20
TLCM226M010#TA	M	22	10	40	2	125	2.2	7.5	3	63	57	25
TLCH336M010#TA	H	33	10	40	2	125	3.3	5	3	89	80	36
TLCH476M010#TA	H	47	10	40	2	125	23.5	7.5	3	73	66	29
TLCR476M010#TA	R	47	10	40	2	125	4.7	5	3	95	85	38
TLCT107M010#TA	T	100	10	40	2	125	10	1	3	200	180	80
16 Volt @ 40°C												
TLCK474M016#TA	K	0.47	16	40	3.2	125	0.5	15	3	32	28	13
TLCK105M016#TA	K	1	16	40	3.2	125	0.8	15	3	32	28	13
TLCL335M016#TA	L	3.3	16	40	3.2	125	0.5	7.5	3	58	52	23
TLCV106M016#TA	V	10	16	40	3.2	125	1.6	2	3	132	119	53

TLC Series



Tantalum Solid Electrolytic Chip Capacitors Consumer Series

RATINGS & PART NUMBER REFERENCE

AVX Part No.	Case Size	Capacitance (µF)	Rated Voltage (V)	Rated Temperature (°C)	Category Voltage (V)	Category Temperature (°C)	DCL Max. (µA)	ESR Max. @ 100kHz (Ω)	MSL	100kHz RMS Current (mA)		
										25°C	85°C	125°C
20 Volt @ 40°C												
TLCH225M020#TA	H	2.2	20	40	4	125	0.5	7.5	3	89	80	36
TLCR106M020#TA	R	10	20	40	4	125	0.6	5	3	95	85	38
25 Volt @ 40°C												
TLCL105M025#TA	L	1.0	25	40	5	125	0.5	7.5	3	58	85	23
TLCR225M025#TA	R	2.2	25	40	5	125	0.6	5	3	95	85	38
35 Volt @ 40°C												
TLCR105M035#TA	R	1.0	35	40	7	125	0.5	5	3	95	85	38

**Please contact manufacturer, availability upon request

Moisture Sensitivity Level (MSL) is defined according to J-STD-020.

All technical data relates to an ambient temperature of +25°C. Capacitance and DF are measured at 120Hz, 0.5V RMS with a maximum DC bias of 2.2 volts. DCL is measured at rated voltage after 5 minutes.

DCL allowed to move up to 2.00 times the limit post mounting. For typical weight and composition see page 222.

NOTE: AVX reserves the right to supply a higher voltage rating or tighter tolerance part in the same case size, to the same reliability standards.

QUALIFICATION TABLE

TEST	TLC series (Temperature range -55°C to +125°C)																	
	Condition				Characteristics													
Endurance	Determine after application of rated voltage for 2000 +48/-0 hours at 40±2°C and then leaving 1-2 hours at room temperature. Also determine of 85°C temperature, category voltage for 2000 +48/-0 hours and then leaving 1-2 hours at room temperature. Power supply impedance to be ≤0.1Ω/V.				Visual examination	no visible damage												
					DCL	1.25 x initial limit												
					ΔC/C	within ±30% of initial value												
					ESR	1.5 x initial limit												
Humidity	Determine after storage without applied voltage at 40±2°C and 90-95% relative humidity for 56 days and then recovery 1-2 hours at room temperature.				Visual examination	no visible damage												
					DCL	2 x initial limit												
					ΔC/C	±30% of initial value												
					ESR	1.25 x initial limit												
Temperature Stability	Step	Temperature°C	Duration (min)	Voltage Applied														
	1	+20±2	15	N/A	+20°C	-55°C	+20°C	+40°C	+60°C	+85°C	+125°C	+20°C						
	2	-55+0/-3	15	N/A	DCL						IL*	n/a	IL*	1.25 x IL*	1.25 x IL*	1.25 x IL*	1.25 x IL*	IL*
	3	+20±2	15	N/A														
	4	+40+2/-0	15	V _R	ΔC/C						n/a	+0/-25%	±5%	+10/-0%	+10/-0%	+20/-0%	+25/-0%	+20/-10%
	5	+60+2/-0	15	0.66 x V _R														
	6	+85+3/-0	15	0.50 x V _R	ESR						IL*	n/a	1.25 x IL*	1.25 x IL*	1.25 x IL*	1.25 x IL*	1.25 x IL*	1.25 x IL*
	7	+125+3/-0	15	0.20 x V _R														
8	+20±2	15	N/A															
Surge Voltage	Test temperature: 40°C±3/0°C Test voltage: 1.3 x rated voltage Series protection resistance 1000±100Ω Discharge resistance: 1000Ω Number of cycles: 1000x Cycle duration: 6 min; 30 sec charge, 5 min 30 sec discharge				Visual examination	no visible damage												
					DCL	2 x initial limit												
					ΔC/C	within ±30% of initial value												
					ESR	1.25 x initial limit												

*Initial Limit

TPC Series



Low ESR TACmicrochip®

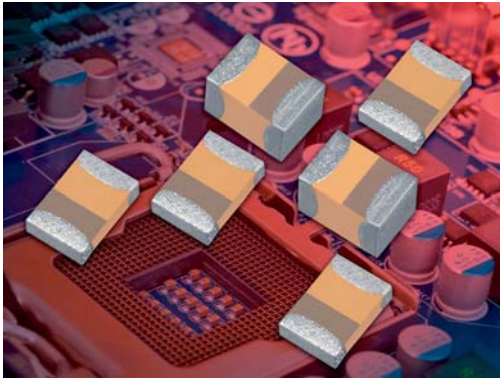

FEATURES

- Low ESR TACmicrochip® capacitor
- Smallest and low profile tantalum
- CV range: 1.0-100µF / 3-25V
- 4 case sizes available
- Power supply applications



APPLICATIONS

- Portable controller with elevated power requirements

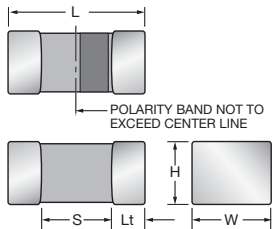

CASE DIMENSIONS: millimeters (inches)

Code	EIA Code	EIA Metric	L+0.20 (0.008) -0.00 (0.000)	W+0.15 (0.008) -0.00 (0.000)	H+0.15 (0.008) -0.00 (0.000)	Termination Spacing(S)	Minimum Termination Length (Lt)
H	0805	2012-10	2.00 (0.079)	1.35 (0.053)	1.00 (0.039) max	0.70 (0.028) min	0.15 (0.006)
K	0402	1005-07	1.00 (0.039)	0.50 ^{+0.20} -0.00 (0.020 ^{+0.008} -0.000)	0.50 ^{+0.20} -0.00 (0.020 ^{+0.008} -0.000)	0.40 (0.016) min	0.10 (0.004)
L	0603	1608-10	1.60 (0.063)	0.85 (0.033)	0.85 (0.033)	0.55 (0.022) min	0.15 (0.006)
R	0805	2012-15	2.00 (0.079)	1.35 (0.053)	1.35 (0.053)	0.70 (0.028) min	0.15 (0.006)

MARKING

H, K, L, R CASE

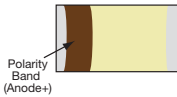

HOW TO ORDER

TPC	R	106	*	010	R	1800
Type TACmicrochip®	Case Size See table above	Capacitance Code pF code: 1st two digits represent significant figures, 3rd digit represents multiplier (number of zeros to follow)	Tolerance K=±10% M=±20%	Rated DC Voltage 003=3Vdc 004=4Vdc 006=6.3Vdc 010=10Vdc 016=16Vdc 020=20Vdc 025=25Vdc	Packaging R, P = 7" Standard Tin Termination Plastic Tape X, Q = 4½" Standard Tin Termination Plastic Tape A, M = 7" Gold Termination Plastic Tape F, N = 4½" Gold Termination Plastic Tape	ESR in mΩ

TECHNICAL SPECIFICATIONS

Technical Data:	All technical data relate to an ambient temperature of +25°C								
Capacitance Range:	1.0 µF to 100 µF								
Capacitance Tolerance:	±10%; ±20%								
Leakage Current DCL:	0.01CV or 0.5µA whichever is the greater								
Rated Voltage (V _R)	≤ +85°C:	3	4	6.3	10	16	20	25	
Category Voltage (V _C)	≤ +125°C:	2	2.7	4	7	10	13	17	
Surge Voltage (V _S)	≤ +85°C:	3.9	5.2	8	13	20	26	32	
Surge Voltage (V _S)	≤ +125°C:	2.6	3.2	5	8	12	16	20	
Temperature Range:	-55°C to +125°C								
Reliability:	1% per 1000 hours at 85°C, V _R with 0.1Ω/V series impedance, 60% confidence level								
Termination Finish:	Nickel and Tin Plating (standard), Nickel and Gold Plating option available upon request								

CAPACITANCE AND RATED VOLTAGE RANGE (LETTER DENOTES CASE SIZE)

Capacitance		Voltage Rating DC (V_R) at 85°C						
μF	Code	3.0V	4.0V	6.3V	10V	16V	20V	25V
1.0	105				L(5000)			R(3000)
1.5	155							
2.2	225			K(8000)/L(5000)	L(5000)	L(5000)		
3.3	335				L(5000)			
4.7	475	K(8000)			L(5000)		R(1500)*	
6.8	685							
10	106			L(4000)	H(2500) L(4000),R(1800)	R(1800)		
15	156			R(1800)	R(1500)			
22	226		L(5000)/R(1800)	R(1500)	R(1500)			
33	336	R(1800)	H(1500)/R(1500)		R(1500)			
47	476	R(1500)		R(1800)				
68	686							
100	107		R(1000)					

Codes shown are examples of ESR values offered on certain CV and case size. Other codes and ESR values available upon request.

Available Ratings, (ESR ratings in mOhms in brackets)

Engineering samples - please contact manufacturer

*Code under development – subject to change

Note: Voltage ratings are minimum values. AVX reserves the right to supply higher ratings in the same case size, to the same reliability standards

TPC Series



Low ESR TACmicrochip®

RATINGS & PART NUMBER REFERENCE

AVX Part No.	Case Size	Capacitance (µF)	Rated Voltage (V)	Rated Temperature (°C)	Category Voltage (V)	Category Temperature (°C)	DCL Max. (µA)	DF Max. (%)	ESR Max. @ 100kHz (mΩ)	MSL	100kHz RMS Current (A)			Product Category
											25°C	85°C	125°C	
3 Volt @ 85°C														
TPCK475*003#8000	K	4.7	3	85	2	125	0.5	12	8000	1	0.043	0.039	0.017	3
TPCR336*003#1800	R	33	3	85	2	125	1.0	10	1800	1	0.158	0.142	0.063	2
TPCR476*003#1500	R	47	3	85	2	125	1.5	10	1500	1	0.173	0.156	0.069	3
4 Volt @ 85°C														
TPCL226*004#5000	L	22	4	85	2.7	125	0.9	6	5000	1	0.071	0.064	0.028	3
TPCR226*004#1800	R	22	4	85	2.7	125	0.9	8	1800	1	0.158	0.142	0.063	1
TPCH336*004#1500	H	33	4	85	2.7	125	1.3	14	1500	1	0.163	0.147	0.065	3
TPCR336*004#1500	R	33	4	85	2.7	125	1.3	10	1500	1	0.173	0.156	0.069	2
TPCR107*004#1000	R	100	4	85	2.7	125	4.0	30	1000	1	0.212	0.191	0.085	3
6.3 Volt @ 85°C														
TPCK225*006#8000	K	2.2	6.3	85	4	125	0.5	8	8000	1	0.043	0.039	0.017	3
TPCL225*006#5000	L	2.2	6.3	85	4	125	0.5	6	5000	1	0.071	0.064	0.028	1
TPCL106*006#4000	L	10	6.3	85	4	125	0.6	10	4000	1	0.079	0.071	0.032	3
TPCR156*006#1800	R	15	6.3	85	4	125	0.9	8	1800	1	0.158	0.142	0.063	1
TPCR226*006#1500	R	22	6.3	85	4	125	1.4	10	1500	1	0.173	0.156	0.069	1
TPCR476*006#1800	R	47	6.3	85	4	125	3.0	20	1800	1	0.158	0.142	0.063	3
10 Volt @ 85°C														
TPCL105*010#5000	L	1.0	10	85	7	125	0.5	6	5000	1	0.071	0.064	0.028	1
TPCL225*010#5000	L	2.2	10	85	7	125	0.5	6	5000	1	0.071	0.064	0.028	1
TPCL335*010#5000	L	3.3	10	85	7	125	0.5	8	5000	1	0.071	0.064	0.028	2
TPCL475*010#5000	L	4.7	10	85	7	125	0.5	10	5000	1	0.071	0.064	0.028	2
TPCH106*010#2500	H	10	10	85	7	125	1.0	8	2500	1	0.126	0.113	0.050	2
TPCL106*010#4000	L	10	10	85	7	125	1.0	20	4000	1	0.079	0.071	0.032	3
TPCR106*010#1800	R	10	10	85	7	125	1.0	8	1800	1	0.158	0.142	0.063	1
TPCR156*010#1500	R	15	10	85	7	125	1.5	10	1500	1	0.173	0.156	0.069	1
TPCR226*010#1500	R	22	10	85	7	125	2.2	14	1500	1	0.173	0.156	0.069	2
TPCR336*010#1500	R	33	10	85	7	125	3.3	20	1500	1	0.173	0.156	0.069	3
16 Volt @ 85°C														
TPCL225*016#5000	L	2.2	16	85	10	125	0.5	10	5000	1	0.071	0.064	0.028	1
TPCR106*016#1800	R	10	16	85	10	125	1.6	10	1800	1	0.158	0.142	0.063	2
20 Volt @ 85°C														
TPCR475*020#1500	R	4.7	20	85	13	125	0.9	8	1500	1	0.173	0.156	0.069	1
25 Volt @ 85°C														
TPCR105*025#3000	R	1.0	25	85	17	125	0.5	8	3000	1	0.122	0.110	0.049	1

Moisture Sensitivity Level (MSL) is defined according to J-STD-020.

All technical data relates to an ambient temperature of +25°C. Capacitance and DF are measured at 120Hz, 0.5V RMS with a maximum DC bias of 2.2 volts. DCL is measured at rated voltage after 5 minutes.

For typical weight and composition see page 222.

NOTE: AVX reserves the right to supply a higher voltage rating or tighter tolerance part in the same case size, to the same reliability standards.

QUALIFICATION TABLE – CATEGORY 1

TEST	TPC series (Temperature range -55°C to +125°C)										
	Condition			Characteristics							
Endurance	Determine after application of rated voltage for 2000 +48/-0 hours at 85±2°C and then leaving 1-2 hours at room temperature. Also determine of 125°C temperature, category voltage for 2000 +48/-0 hours and then leaving 1-2 hours at room temperature. Power supply impedance to be ≤0.1Ω/V.			Visual examination	no visible damage						
				DCL	1.25 x initial limit						
				ΔC/C	within ±10% of initial value						
				DF	1.5 x initial limit						
				ESR	1.5 x initial limit						
Humidity	Determine after storage without applied voltage at 40±2°C and 90-95% relative humidity for 1344 +48/-0 hours and then recovery 1-2 hours at room temperature			Visual examination	no visible damage						
				DCL	initial limit						
				ΔC/C	within ±5% of initial value						
				DF	1.2 x initial limit						
				ESR	1.2 x initial limit						
Temperature Stability	Step	Temperature°C	Duration(min)		+20°C	-55°C	+20°C	+85°C	+125°C	+20°C	
	1	+20±2	15	DCL	IL*	n/a	IL*	10 x IL*	12.5 x IL*	IL*	
	2	-55+0/-3	15		ΔC/C	n/a	+0/-10%	±5%	+10/-0%	+15/-0%	±5%
	3	+20±2	15	DF		IL*	1.5 x IL*	IL*	1.5 x IL*	2 x IL*	IL*
	4	+85+3/-0	15		ESR	IL*	1.25 x IL*	IL*	1.25 x IL*	2 x IL*	IL*
	5	+125+3/-0	15								
	6	+20±2	15								
Surge Voltage	Test temperature: 85°C+3/0°C Test voltage: 1.3 x rated voltage Series protection resistance 1000±100Ω Discharge resistance: 1000Ω Number of cycles: 1000x Cycle duration: 6 min; 30 sec charge, 5 min 30 sec discharge			Visual examination	no visible damage						
				DCL	initial limit						
				ΔC/C	within ±10% of initial value						
				DF	initial limit						
				ESR	initial limit						

*Initial Limit

QUALIFICATION TABLE – CATEGORY 2

TEST	TPC series (Temperature range -55°C to +125°C)										
	Condition			Characteristics							
Endurance	Determine after application of rated voltage for 2000 +48/-0 hours at 85±2°C and then leaving 1-2 hours at room temperature. Also determine of 125°C temperature, category voltage for 2000 +48/-0 hours and then leaving 1-2 hours at room temperature. Power supply impedance to be ≤0.1Ω/V.			Visual examination	no visible damage						
				DCL	1.25 x initial limit						
				ΔC/C	within ±15% of initial value						
				DF	1.5 x initial limit						
				ESR	1.5 x initial limit						
Humidity	Determine after storage without applied voltage at 40±2°C and 90-95% relative humidity for 1344 +48/-0 hours and then recovery 1-2 hours at room temperature			Visual examination	no visible damage						
				DCL	initial limit						
				ΔC/C	within ±10% of initial value						
				DF	1.2 x initial limit						
				ESR	1.2 x initial limit						
Temperature Stability	Step	Temperature°C	Duration(min)		+20°C	-55°C	+20°C	+85°C	+125°C	+20°C	
	1	+20±2	15	DCL	IL*	n/a	IL*	10 x IL*	12.5 x IL*	IL*	
	2	-55+0/-3	15		ΔC/C	n/a	+0/-15%	±5%	+15/-0%	+20/-0%	±5%
	3	+20±2	15	DF		IL*	1.5 x IL*	IL*	1.5 x IL*	2 x IL*	IL*
	4	+85+3/-0	15		ESR	IL*	1.25 x IL*	IL*	1.25 x IL*	2 x IL*	IL*
	5	+125+3/-0	15								
	6	+20±2	15								
Surge Voltage	Test temperature: 85°C+3/0°C Test voltage: 1.3 x rated voltage Series protection resistance 1000±100Ω Discharge resistance: 1000Ω Number of cycles: 1000x Cycle duration: 6 min; 30 sec charge, 5 min 30 sec discharge			Visual examination	no visible damage						
				DCL	1.5 x initial limit						
				ΔC/C	within ±15% of initial value						
				DF	1.5 x initial limit						
				ESR	1.5 x initial limit						

*Initial Limit

QUALIFICATION TABLE – CATEGORY 3

TEST	TPC series (Temperature range -55°C to +125°C)										
	Condition			Characteristics							
Endurance	Determine after application of rated voltage for 2000 +48/-0 hours at 85±2°C and then leaving 1-2 hours at room temperature. Also determine of 125°C temperature, category voltage for 2000 +48/-0 hours and then leaving 1-2 hours at room temperature. Power supply impedance to be ≤0.1Ω/V.			Visual examination	no visible damage						
				DCL	1.25 x initial limit						
				ΔC/C	within ±30% of initial value						
				DF	1.5 x initial limit						
				ESR	1.5 x initial limit						
Humidity	Determine after storage without applied voltage at 40±2°C and 90-95% relative humidity for 1344 +48/-0 hours and then recovery 1-2 hours at room temperature			Visual examination	no visible damage						
				DCL	2 x initial limit						
				ΔC/C	within ±30% of initial value						
				DF	1.5 x initial limit						
				ESR	1.25 x initial limit						
Temperature Stability	Step	Temperature°C	Duration(min)		+20°C	-55°C	+20°C	+85°C	+125°C	+20°C	
	1	+20±2	15	DCL	IL*	n/a	IL*	10 x IL*	12.5 x IL*	IL*	
	2	-55+0/-3	15		ΔC/C	n/a	+0/-25%	±5%	+20/-0%	+25/-0%	±20%
	3	+20±2	15	DF		IL*	1.5 x IL*	IL*	1.5 x IL*	2 x IL*	1.5 x IL*
	4	+85+3/-0	15		ESR	IL*	1.25 x IL*	IL*	1.25 x IL*	2 x IL*	1.5 x IL*
	5	+125+3/-0	15								
	6	+20±2	15								
Surge Voltage	Test temperature: 85°C+3/0°C Test voltage: 1.3 x rated voltage Series protection resistance 1000±100Ω Discharge resistance: 1000Ω Number of cycles: 1000x Cycle duration: 6 min; 30 sec charge, 5 min 30 sec discharge			Visual examination	no visible damage						
				DCL	2 x initial limit						
				ΔC/C	within ±30% of initial value						
				DF	2 x initial limit						
				ESR	2 x initial limit						

*Initial Limit

F95 Series



Standard Conformal Coated Chip



FEATURES

- Compliant to the RoHS2 directive 2011/65/EU
- For high frequency
- SMD Conformal
- Small and high CV



APPLICATIONS

- Smartphone
- Tablet PC
- Wireless module
- e-book

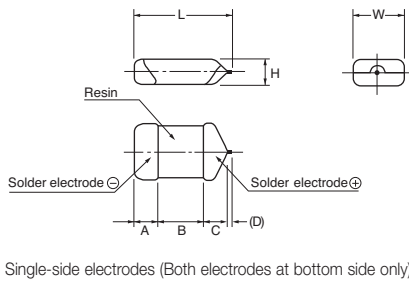

CASE DIMENSIONS: millimeters (inches)

Code	EIA Code	EIA Metric	L	W	H	A	B	C	D*
A	1207	3217-16	3.20±0.30 (0.126±0.012)	1.70±0.30 (0.067±0.008)	1.40±0.20 (0.055±0.008)	0.80±0.30 (0.031±0.012)	1.20±0.30 (0.047±0.012)	0.80±0.30 (0.031±0.012)	0.20 (0.008)
B	1411	3528-20	3.50±0.20 (0.138±0.012)	2.80±0.20 (0.110±0.012)	1.80±0.20 (0.031±0.008)	0.80±0.30 (0.031±0.012)	1.20±0.30 (0.047±0.012)	1.10±0.30 (0.043±0.012)	0.20 (0.008)
P	0905	2212-12	2.20±0.30 (0.087±0.012)	1.25±0.30 (0.049±0.012)	1.00±0.20 (0.039±0.008)	0.60±0.30 (0.024±0.012)	0.80±0.30 (0.031±0.012)	0.80±0.30 (0.031±0.012)	0.20 (0.008)
Q	1306	3216-10	3.20±0.20 (0.126±0.008)	1.60±0.20 (0.063±0.008)	0.80±0.20 (0.031±0.008)	0.80±0.20 (0.031±0.008)	1.20±0.20 (0.047±0.008)	0.80±0.20 (0.031±0.008)	0.20 (0.008)
R	0905	2212-065	2.20±0.30 (0.087±0.012)	1.25±0.30 (0.049±0.012)	0.65 max. (0.026 max.)	0.60±0.30 (0.024±0.012)	0.80±0.30 (0.031±0.012)	0.50 min. (0.020 min.)	0.20 (0.008)
S	1306	3216-12	3.20±0.30 (0.126±0.012)	1.60±0.30 (0.063±0.008)	1.00±0.20 (0.039±0.008)	0.80±0.30 (0.031±0.012)	1.20±0.30 (0.047±0.012)	0.80±0.30 (0.031±0.012)	0.20 (0.008)
T	1411	3527-12	3.50±0.20 (0.138±0.012)	2.70±0.20 (0.106±0.012)	1.00±0.20 (0.039±0.008)	0.80±0.20 (0.031±0.008)	1.20±0.20 (0.047±0.008)	1.10±0.30 (0.043±0.012)	0.20 (0.008)

*D dimension only for reference

HOW TO ORDER

F95	0G	337	M	A		AQ2
Type	Rated Voltage	Capacitance Code	Tolerance	Case Size	Packaging	Single Face Electrode
		pF code: 1st two digits represent significant figures, 3rd digit represents multiplier (number of zeros to follow)	K = ±10% M = ±20%	See table above	See Tape & Reel Packaging Section	

TECHNICAL SPECIFICATIONS

Category Temperature Range:	-55 to +125°C
Rated Temperature:	+85°C
Capacitance Tolerance:	±20%, ±10% at 120Hz, R & P Case ±20%
Dissipation Factor:	Refer to next page
ESR 100kHz:	Refer to next page
Leakage Current:	Refer to next page Provided that: After 1 minute's application of rated voltage, leakage current at 85°C 10 times or less than 20°C specified value. After 1 minute's application of rated voltage, leakage current at 125°C 12.5 times or less than 20°C specified value.
Capacitance Change By Temperature	+15% Max. at +125°C +10% Max. at +85°C -10% Max. at -55°C

F95 Series



Standard Conformal Coated Chip

CAPACITANCE AND RATED VOLTAGE RANGE (LETTER DENOTES CASE SIZE)

Capacitance		Rated Voltage						
µF	Code	4V (0G)	6.3V (0J)	10V (1A)	16V (1C)	20V (1D)	25V (1E)	35V (1V)
1.0	105						R	P/S
1.5	155							
2.2	225					P	P/R	A
3.3	335							
4.7	475				P/R	A/S	A/P/Q/S	B
6.8	685						Q*/S*	
10	106			P/R	A/P/Q/S	A/B/S	A/B/T*	
15	156			P	A/S			
22	226		R	A/P/Q/S	A/B/Q/S/T	B		
33	336		P/R*	A/P/Q/S	A*/B/T	B		
47	476	R*	P	A/B/P/Q*/S/T	B			
68	686		P	B				
100	107	A/P/S	A/B/P/Q/S/T	A/B/S*/T				
150	157	B/P	B					
220	227	A/B/P*/Q/S/T	A*/B/S*/T*					
330	337	A/B/P*/S*/T	B					
470	477	A*/B/P*/T*	B*					
680	687	T*						

Available Ratings

*Codes under development – subject to change

Please contact to your local AVX sales office when these series are being designed in your application.

F95 Series



Standard Conformal Coated Chip

RATINGS & PART NUMBER REFERENCE

AVX Part No.	Case Size	Capacitance (µF)	Rated Voltage (V)	*2 DCL (µA)	DF @ 120Hz (%)	ESR @ 100kHz (Ω)	*1 ΔC/C (%)
4 Volt							
F950G107MAAAQ2	A	100	4	4.0	12	0.5	*
F950G107MPAAQ2	P	100	4	4.0	30	1.2	±15
F950G107MSAAQ2	S	100	4	4.0	14	0.8	*
F950G157MBAAQ2	B	150	4	6.0	14	0.4	*
F950G157MPAAQ2	P	150	4	12.0	31	1.1	±20
F950G227MAAAQ2	A	220	4	8.8	25	0.8	±15
F950G227MBAAQ2	B	220	4	8.8	16	0.4	*
F950G227MQAAQ2	Q	220	4	8.8	30	1.5	±20
F950G227MSAAQ2	S	220	4	8.8	30	0.8	±15
F950G227MTAAQ2	T	220	4	8.8	25	0.6	*
F950G337MAAAQ2	A	330	4	13.2	40	0.8	±20
F950G337MBAAQ2	B	330	4	13.2	30	0.6	±15
F950G337MTAAQ2	T	330	4	13.2	40	0.8	±20
F950G477MBAAQ2	B	470	4	18.8	40	0.4	±20
6.3 Volt							
F950J336MPAAQ2	P	33	6.3	2.1	14	1.1	*
F950J226MRAAQ2	R	22	6.3	1.4	20	2.0	±20
F950J476MPAAQ2	P	47	6.3	3.0	20	1.1	±15
F950J686MPAAQ2	P	68	6.3	4.3	25	1.2	±15
F950J107MAAAQ2	A	100	6.3	6.3	14	0.5	*
F950J107MBAAQ2	B	100	6.3	6.3	14	0.4	*
F950J107MPAAQ2	P	100	6.3	12.6	35	1.2	±20
F950J107MQAAQ2	Q	100	6.3	6.3	30	1.1	±20
F950J107MSAAQ2	S	100	6.3	6.3	20	0.9	±15
F950J107MTAAQ2	T	100	6.3	6.3	14	0.6	*
F950J157MBAAQ2	B	150	6.3	9.5	18	0.4	*
F950J227MBAAQ2	B	220	6.3	13.9	30	0.4	*
F950J337MBAAQ2	B	330	6.3	20.8	35	0.6	±20
10 Volt							
F951A106MPAAQ2	P	10	10	1.0	8	3.0	*
F951A106MRAAQ2	R	10	10	1.0	18	3.0	±20
F951A156MPAAQ2	P	15	10	1.5	10	3.0	*
F951A226MAAAQ2	A	22	10	2.2	6	0.9	*
F951A226MPAAQ2	P	22	10	2.2	14	3.0	*
F951A226MQAAQ2	Q	22	10	2.2	10	2.0	*
F951A226MSAAQ2	S	22	10	2.2	10	1.1	*
F951A336MAAAQ2	A	33	10	3.3	10	0.8	*
F951A336MPAAQ2	P	33	10	3.3	20	3.0	±15
F951A336MQAAQ2	Q	33	10	3.3	18	3.0	±15
F951A336MSAAQ2	S	33	10	3.3	10	1.1	*
F951A476MAAAQ2	A	47	10	4.7	10	0.8	*
F951A476MBAAQ2	B	47	10	4.7	8	0.4	*
F951A476MPAAQ2	P	47	10	4.7	30	3.0	±20
F951A476MSAAQ2	S	47	10	4.7	14	1.1	±15

1: ΔC/C Marked “”

Item	All Case (%)
Damp Heat	±10
Temperature cycles	±5
Resistance soldering heat	±5
Surge	±5
Endurance	±10

*2: Leakage Current

After 1 minute's application of rated voltage, leakage current at 20°C.

AVX Part No.	Case Size	Capacitance (µF)	Rated Voltage (V)	*2 DCL (µA)	DF @ 120Hz (%)	ESR @ 100kHz (Ω)	*1 ΔC/C (%)
F951A476MTAAQ2	T	47	10	4.7	12	0.8	*
F951A686MBAAQ2	B	68	10	6.8	12	0.4	*
F951A107MAAAQ2	A	100	10	10.0	35	1.0	±15
F951A107MBAAQ2	B	100	10	10.0	14	0.4	*
F951A107MTAAQ2	T	100	10	10.0	20	0.6	±15
16 Volt							
F951C475MPAAQ2	P	4.7	16	0.8	10	4.0	*
F951C475MRAAQ2	R	4.7	16	0.8	12	6.0	±20
F951C106MAAAQ2	A	10	16	1.6	6	1.4	*
F951C106MPAAQ2	P	10	16	1.6	10	4.0	*
F951C106MQAAQ2	Q	10	16	1.6	8	3.0	*
F951C106MSAAQ2	S	10	16	1.6	8	2.0	*
F951C156MAAAQ2	A	15	16	2.4	8	1.4	*
F951C156MSAAQ2	S	15	16	2.4	8	2.0	*
F951C226MAAAQ2	A	22	16	3.5	8	1.4	*
F951C226MBAAQ2	B	22	16	3.5	6	0.5	*
F951C226MQAAQ2	Q	22	16	3.5	12	3.0	*
F951C226MSAAQ2	S	22	16	3.5	10	2.0	±15
F951C226MTAAQ2	T	22	16	3.5	8	1.4	*
F951C336MBAAQ2	B	33	16	5.3	8	0.5	*
F951C336MTAAQ2	T	33	16	5.3	11	1.5	±10
F951C476MBAAQ2	B	47	16	7.5	10	0.6	*
20 Volt							
F951D225MPAAQ2	P	2.2	20	0.5	6	6.0	*
F951D475MAAAQ2	A	4.7	20	0.9	6	1.5	*
F951D475MSAAQ2	S	4.7	20	0.9	8	4.0	*
F951D106MAAAQ2	A	10	20	2.0	8	1.5	*
F951D106MBAAQ2	B	10	20	2.0	6	0.8	*
F951D106MSAAQ2	S	10	20	2.0	10	4.0	±10
F951D226MBAAQ2	B	22	20	4.4	8	0.8	*
F951D336MBAAQ2	B	33	20	6.6	15	1.0	*
25 Volt							
F951E105MRAAQ2	R	1	25	0.5	10	10.0	±10
F951E225MPAAQ2	P	2.2	25	0.6	8	6.0	±15
F951E225MRAAQ2	R	2.2	25	0.6	15	15.0	±20
F951E475MAAAQ2	A	4.7	25	1.2	8	2.0	*
F951E475MPAAQ2	P	4.7	25	1.2	10	8.0	±15
F951E475MQAAQ2	Q	4.7	25	1.2	10	4.0	±15
F951E475MSAAQ2	S	4.7	25	1.2	8	4.0	*
F951E106MAAAQ2	A	10	25	2.5	12	2.0	±15
F951E106MBAAQ2	B	10	25	2.5	6	0.9	*
35 Volt							
F951V105MPAAQ2	P	1	35	0.5	8	10.0	±10
F951V105MSAAQ2	S	1	35	0.5	6	8.0	*
F951V225MAAAQ2	A	2.2	35	0.8	6	4.4	*
F951V475MBAAQ2	B	4.7	35	1.7	6	1.6	*

* In case of capacitance tolerance ± 10% type, “K” will be put at 9th digit of type numbering system

QUALIFICATION TABLE

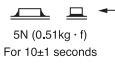
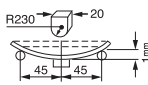
TEST	F95 series (Temperature range -55°C to +125°C)	
	Condition	
Damp Heat (Steady State)	At 40°C, 90 to 95% R.H., 500 hours (No voltage applied) Capacitance Change Refer to page 133 (*1) Dissipation Factor Initial specified value or less Leakage Current Initial specified value or less	
Temperature Cycles	At -55°C / +125°C, 30 minutes each, 5 cycles Capacitance Change Refer to page 133 (*1) Dissipation Factor Initial specified value or less Leakage Current Initial specified value or less	
Resistance to Soldering Heat	10 seconds reflow at 260°C, 10 seconds immersion at 260°C. Capacitance Change Refer to page 133 (*1) Dissipation Factor Initial specified value or less Leakage Current Initial specified value or less	
Surge	After application of surge voltage in series with a 33Ω resistor at the rate of 30 seconds ON, 30 seconds OFF, for 1000 successive test cycles at 85°C, capacitors shall meet the characteristic requirements in the table above. Capacitance Change Refer to page 133 (*1) Dissipation Factor Initial specified value or less Leakage Current Initial specified value or less	
Endurance	After 2000 hours' application of rated voltage at 85°C, capacitors shall meet the characteristic requirements in the table above. Capacitance Change Refer to page 133 (*1) Dissipation Factor Initial specified value or less Leakage Current Initial specified value or less	
Shear Test	After applying the pressure load of 5N for 10±1 seconds horizontally to the center of capacitor side body which has no electrode and has been soldered beforehand on a substrate, there shall be found neither exfoliation nor its sign at the terminal electrode.	
Terminal Strength	Keeping a capacitor surface-mounted on a substrate upside down and supporting the substrate at both of the opposite bottom points 45mm apart from the center of capacitor, the pressure strength is applied with a specified jig at the center of substrate so that the substrate may bend by 1mm as illustrated. Then, there shall be found no remarkable abnormality on the capacitor terminals.	

AUDIO F95 Series



Conformal Coated Chip Optimized for Audio Applications



FEATURES

- Compliant to the RoHS2 directive 2011/65/EU
- Rich sound in the bass register and clear sound, Materials are strictly selected to achieve high level sound. F95 series has no lead-frame, and no vibration factor
- Low ESR, Low ESL
- Line up miniature size and high capacitance, necessary to mobile design
- SMD conformal
- Small and high CV

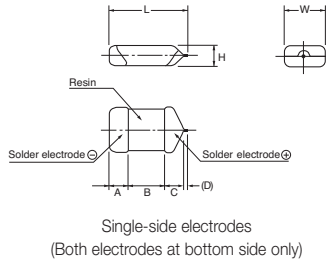

APPLICATIONS

- Mobile Audio Player
- Smartphone
- Mobile phone
- Wireless Microphone System

CASE DIMENSIONS: millimeters (inches)

Code	EIA Code	EIA Metric	L	W	H	A	B	C	D*
A	1207	3217-16	3.20±0.30 (0.126±0.012)	1.70±0.30 (0.067±0.008)	1.40±0.20 (0.055±0.008)	0.80±0.30 (0.031±0.012)	1.20±0.30 (0.047±0.012)	0.80±0.30 (0.031±0.012)	0.20 (0.008)
B	1411	3528-20	3.50±0.20 (0.138±0.012)	2.80±0.20 (0.110±0.012)	1.80±0.20 (0.031±0.008)	0.80±0.30 (0.031±0.012)	1.20±0.30 (0.047±0.012)	1.10±0.30 (0.043±0.012)	0.20 (0.008)
P	0905	2212-12	2.20±0.30 (0.087±0.012)	1.25±0.30 (0.049±0.012)	1.00±0.20 (0.039±0.008)	0.60±0.30 (0.024±0.012)	0.80±0.30 (0.031±0.012)	0.80±0.30 (0.031±0.012)	0.20 (0.008)
S	1306	3216-12	3.20±0.30 (0.126±0.012)	1.60±0.30 (0.063±0.008)	1.00±0.20 (0.039±0.008)	0.80±0.30 (0.031±0.012)	1.20±0.30 (0.047±0.012)	0.80±0.30 (0.031±0.012)	0.20 (0.008)
T	1411	3527-12	3.50±0.20 (0.138±0.012)	2.70±0.20 (0.106±0.012)	1.00±0.20 (0.039±0.008)	0.80±0.20 (0.031±0.008)	1.20±0.20 (0.047±0.008)	1.10±0.30 (0.043±0.012)	0.20 (0.008)

*D dimension only for reference

MARKING

A, S CASE



Capacitance Code

B, T CASE



Capacitance Code

μF	68	100	150	220	330	470	680
code	W7	A8	E8	J8	N8	S8	W8

P case - No marking on part.

HOW TO ORDER

F95

Type

0G

Rated Voltage

227

Capacitance Code

pF code: 1st two digits represent significant figures, 3rd digit represents multiplier (number of zeros to follow)

M

Tolerance
K = ±10%
M = ±20%

S

Case Size
See table above



Packaging
See Tape & Reel Packaging Section

AM1

AUDIO Series Code

Q2

Single Face Electrode

TECHNICAL SPECIFICATIONS

Category Temperature Range:	-55 to +125°C
Rated Temperature:	+85°C
Capacitance Tolerance:	±20%, ±10% at 120Hz
Dissipation Factor:	Refer to next page
ESR 100kHz:	Refer to next page
Leakage Current:	Refer to next page Provided that: After 1 minute's application of rated voltage, leakage current at 85°C 10 times or less than 20°C specified value. After 1 minute's application of rated voltage, leakage current at 125°C 12.5 times or less than 20°C specified value.
Capacitance Change By Temperature	+15% Max. at +125°C +10% Max. at +85°C -10% Max. at -55°C

AUDIO F95 Series



Conformal Coated Chip Optimized for Audio Applications

CAPACITANCE AND RATED VOLTAGE RANGE (LETTER DENOTES CASE SIZE)

Capacitance		Rated Voltage		
μF	Code	4V (0G)	6.3V (0J)	10V (1A)
68	686	S	S	B
100	107	S	S/T	B
150	157	S	A*	
220	227	P*/S/T	A*/B/T*	
330	337	T	B	
470	477	B/T*	B*	
680	687	B*/T*		

Available Ratings

*Codes under development – subject to change

Please contact to your local AVX sales office when these series are being designed in your application.

RATINGS & PART NUMBER REFERENCE

AVX Part No.	Case Size	Capacitance (μF)	Rated Voltage (V)	*2 DCL (μA)	DF @ 120Hz (%)	ESR @ 100kHz (Ω)	*1 ΔC/C (%)
4 Volt							
F950G686MSAAM1Q2	S	68	4	2.7	10	0.8	*
F950G107MSAAM1Q2	S	100	4	4.0	14	0.8	*
F950G157MSAAM1Q2	S	150	4	6.0	22	0.8	±15
F950G227MSAAM1Q2	S	220	4	8.8	30	0.8	±15
F950G227MTAAM1Q2	T	220	4	8.8	25	0.6	*
F950G337MTAAM1Q2	T	330	4	13.2	40	0.8	±20
F950G477MBAAM1Q2	B	470	4	18.8	40	0.4	±20
6.3 Volt							
F950J686MSAAM1Q2	S	68	6.3	4.3	14	0.9	*
F950J107MSAAM1Q2	S	100	6.3	6.3	20	0.9	±15
F950J107MTAAM1Q2	T	100	6.3	6.3	14	0.6	*
F950J227MBAAM1Q2	B	220	6.3	13.9	30	0.4	*
F950J337MBAAM1Q2	B	330	6.3	20.8	35	0.6	±20
10 Volt							
F951A686MBAAM1Q2	B	68	10	6.8	12	0.4	*
F951A107MBAAM1Q2	B	100	10	10.0	14	0.4	*

* In case of capacitance tolerance ± 10% type, "K" will be put at 9th digit of type numbering system

1: ΔC/C Marked ""

Item	A, B, S, T Case (%)
Damp Heat	±10
Temperature cycles	±5
Resistance soldering heat	±5
Surge	±5
Endurance	±10

*2: Leakage Current

After 1 minute's application of rated voltage, leakage current at 20°C.

AUDIO F95 Series



Conformal Coated Chip Optimized for Audio Applications

QUALIFICATION TABLE

TEST	AUDIO F95 series (Temperature range -55°C to +125°C)	
	Condition	
Damp Heat (Steady State)	At 40°C, 90 to 95% R.H., 500 hours (No voltage applied) Capacitance Change Refer to page 136 (*1) Dissipation Factor Initial specified value or less Leakage Current Initial specified value or less	
Temperature Cycles	At -55°C / +125°C, 30 minutes each, 5 cycles Capacitance Change Refer to page 136 (*1) Dissipation Factor Initial specified value or less Leakage Current Initial specified value or less	
Resistance to Soldering Heat	10 seconds reflow at 260°C, 5 seconds immersion at 260°C. Capacitance Change Refer to page 136 (*1) Dissipation Factor Initial specified value or less Leakage Current Initial specified value or less	
Surge	After application of surge voltage in series with a 33Ω resistor at the rate of 30 seconds ON, 30 seconds OFF, for 1000 successive test cycles at 85°C, capacitors shall meet the characteristic requirements in the table above. Capacitance Change Refer to page 136 (*1) Dissipation Factor Initial specified value or less Leakage Current Initial specified value or less	
Endurance	After 2000 hours' application of rated voltage 85°C, capacitors shall meet the characteristic requirements in the table above. Capacitance Change Refer to page 136 (*1) Dissipation Factor Initial specified value or less Leakage Current Initial specified value or less	
Shear Test	After applying the pressure load of 5N for 10±1 seconds horizontally to the center of capacitor side body which has no electrode and has been soldered beforehand on a substrate, there shall be found neither exfoliation nor its sign at the terminal electrode.	
Terminal Strength	Keeping a capacitor surface-mounted on a substrate upside down and supporting the substrate at both of the opposite bottom points 45mm apart from the center of capacitor, the pressure strength is applied with a specified jig at the center of substrate so that the substrate may bend by 1mm as illustrated. Then, there shall be found no remarkable abnormality on the capacitor terminals.	

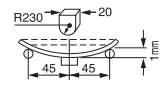

F72/F75 Series



Low Profile and HiCV Conformal Coated Chip



FEATURES

- Compliant to the RoHS2 directive 2011/65/EU
- SMD Conformal
- Small and low profile



APPLICATIONS

- Smartphone
- Mobile phone
- Wireless module
- Hearing aid

CASE DIMENSIONS: millimeters (inches)

Code	EIA Code	EIA Metric	L	W	H	A	B	D*
F72 Case Dimensions								
M	2824	7260-20	7.20±0.30 (0.283±0.012)	6.00±0.30 (0.236±0.012)	2.00 Max. (0.079 Max)	1.30±0.40 (0.051±0.016)	3.80±0.60 (0.150±0.024)	6.20 (0.244)
R	2824	7260-15	7.20±0.30 (0.283±0.012)	6.00±0.30 (0.236±0.012)	1.20±0.30 (0.047±0.012)	1.30±0.40 (0.051±0.016)	3.80±0.60 (0.150±0.024)	6.20 (0.244)
F75 Case Dimensions								
C	2813	7132-28	7.10±0.30 (0.280±0.012)	3.20±0.30 (0.126±0.012)	2.50±0.30 (0.098±0.012)	1.30±0.30 (0.051±0.012)	3.60±0.60 (0.142±0.024)	6.00 (0.236)
D	2914	7343-31	7.30±0.30 (0.287±0.012)	4.30±0.30 (0.136±0.012)	2.80±0.30 (0.110±0.012)	1.30±0.40 (0.051±0.016)	3.90±0.60 (0.153±0.024)	6.40 (0.252)
R	2824	7260-38	7.20±0.30 (0.283±0.012)	6.00±0.30 (0.236±0.012)	3.50±0.30 (0.138±0.012)	1.30±0.40 (0.051±0.016)	3.80±0.60 (0.150±0.024)	6.20 (0.244)
U	2813	7132-20	7.10±0.30 (0.280±0.012)	3.20±0.30 (0.126±0.012)	2.00 Max. (0.079 Max)	1.30±0.30 (0.051±0.012)	3.60±0.60 (0.142±0.024)	6.00 (0.236)

*D dimension only for reference

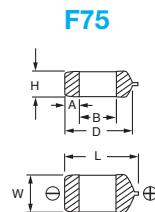
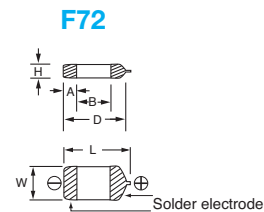

HOW TO ORDER

F72	1A	107	M	R		AQ2
Type	Rated Voltage	Capacitance Code	Tolerance	Case Size	Packaging	Single Facing Electrode
		pF code: 1st two digits represent significant figures, 3rd digit represents multiplier (number of zeros to follow)	K = ±10% M = ±20%	See table above	See Tape & Reel Packaging Section	
F75	1C	157	M	D		AQ2
Type	Rated Voltage	Capacitance Code	Tolerance	Case Size	Packaging	Single Facing Electrode
		pF code: 1st two digits represent significant figures, 3rd digit represents multiplier (number of zeros to follow)	K = ±10% M = ±20%	See table above	See Tape & Reel Packaging Section	

TECHNICAL SPECIFICATIONS

Category Temperature Range:	-55 to +125°C
Rated Temperature:	+85°C
Capacitance Tolerance:	±20%, ±10% at 120Hz
Dissipation Factor:	Refer to next page
ESR 100kHz:	Refer to next page
Leakage Current:	After 1 minute's application of rated voltage, leakage current at 20°C is not more than 0.01CV or 0.5µA, whichever is greater. After 1 minute's application of rated voltage, leakage current at 85°C is not more than 0.1CV or 5µA, whichever is greater. After 1 minute's application of derated voltage, leakage current at 125°C is not more than 0.125CV or 6.3µA, whichever is greater.
Capacitance Change By Temperature	+15% Max. at +125°C +10% Max. at +85°C -10% Max. at -55°C

F72/F75 Series



Low Profile and HiCV Conformal Coated Chip

CAPACITANCE AND RATED VOLTAGE RANGE (LETTER DENOTES CASE SIZE)

F72

Capacitance		Rated Voltage			
µF	Code	4V (0G)	6.3V (0J)	10V (1A)	16V (1C)
33	336				R
47	476			R	R
68	686		R	R	R
100	107	R	R	R	
150	157	R	R	R	
220	227	R	R	R	M
330	337	R	R	R*	M
470	477			M	
680	687			M	
1000	108		M	M	
1500	158		M		

Available Ratings

*Codes under development – subject to change

RATINGS & PART NUMBER REFERENCE

F72

AVX Part No.	Case Size	Capacitance (µF)	Rated Voltage (V)	DCL (µA)	DF @ 120Hz (%)	ESR @ 100kHz (Ω)	100kHz RMS Current (mA)	+1 ΔC/C (%)
4 Volt								
F720G107MRC	R	100	4	4.0	8	0.70	463	*
F720G157MRC	R	150	4	6.0	10	0.70	463	*
F720G227MRC	R	220	4	8.8	12	0.70	463	*
F720G337MRC	R	330	4	13.2	12	0.70	463	*
6.3 Volt								
F720J686MRC	R	68	6.3	4.3	6	0.75	447	*
F720J107MRC	R	100	6.3	6.3	8	0.70	463	*
F720J157MRC	R	150	6.3	9.5	10	0.70	463	*
F720J227MRC	R	220	6.3	13.9	12	0.70	463	*
F720J337MRC	R	330	6.3	20.8	12	0.70	463	*
F720J108MMCAQ2	M	1000	6.3	63.0	30	0.14	1118	±15
F720J158MMCAQ2	M	1500	6.3	95.0	45	0.14	1118	±20
10 Volt								
F721A476MRC	R	47	10	4.7	6	0.80	433	*
F721A686MRC	R	68	10	6.8	6	0.75	447	*
F721A107MRC	R	100	10	10.0	8	0.70	463	*
F721A157MRC	R	150	10	15.0	10	0.70	463	*
F721A227MRC	R	220	10	22.0	12	0.70	463	*
F721A477MMCAQ2	M	470	10	47.0	30	0.14	1118	±15
F721A687MMCAQ2	M	680	10	68.0	35	0.14	1118	±20
F721A108MMCAQ2	M	1000	10	200	45	0.14	1118	±20
16 Volt								
F721C336MRC	R	33	16	5.3	6	0.90	408	*
F721C476MRC	R	47	16	7.5	6	0.80	433	*
F721C686MRC	R	68	16	10.9	6	0.75	447	*
F721C227MMCAQ2	M	220	16	35.2	12	0.20	935	±20
F721C337MMCAQ2	M	330	16	52.8	45	0.20	935	±20

* In case of capacitance tolerance ± 10% type, "K" will be put at 9th digit of type numbering system

1: ΔC/C Marked ""

Item	F72 All Case (%)
Damp Heat	±10
Temperature cycles	±5
Resistance soldering heat	±5
Surge	±5
Endurance	±10

F75

Capacitance		Rated Voltage			
µF	Code	4V (0G)	6.3V (0J)	10V (1A)	16V (1C)
68	686				C
100	107				C
150	157			C	D
220	227		C	C/D	R
330	337	C	C/D	D	
470	477	C/D	D/U	R/U	
680	687	D	D/R/U*		
1000	108	D/R	R/U*		
1500	158	R			
2200	228	R			

Please contact to your local AVX sales office when these series are being designed in your application.

F75

AVX Part No.	Case Size	Capacitance (µF)	Rated Voltage (V)	DCL (µA)	DF @ 120Hz (%)	ESR @ 100kHz (Ω)	100kHz RMS Current (mA)	+1 ΔC/C (%)
4 Volt								
F750G337MCC	C	330	4	13.2	10	0.15	856	*
F750G477MCC	C	470	4	18.8	14	0.12	957	*
F750G477MDC	D	470	4	18.8	14	0.12	1118	*
F750G687MDC	D	680	4	27.2	18	0.12	1118	*
F750G108MDC	D	1000	4	40.0	24	0.12	1118	*
F750G108MRC	R	1000	4	40.0	24	0.12	1443	*
F750G158MRC	R	1500	4	60.0	30	0.12	1443	*
F750G228MRC	R	2200	4	88.0	45	0.07	1890	*
6.3 Volt								
F750J227MCC	C	220	6.3	13.9	10	0.20	742	*
F750J337MCC	C	330	6.3	20.8	10	0.15	856	*
F750J337MDC	D	330	6.3	20.8	10	0.15	1000	*
F750J477MDC	D	470	6.3	29.6	14	0.12	1118	*
F750J477MUC	U	470	6.3	29.6	15	0.10	1049	*
F750J687MDC	D	680	6.3	42.8	18	0.12	1118	*
F750J687MRC	R	680	6.3	42.8	18	0.12	1443	*
F750J108MRC	R	1000	6.3	63.0	24	0.12	1443	*
10 Volt								
F751A157MCC	C	150	10	15.0	10	0.22	707	*
F751A227MCC	C	220	10	22.0	10	0.20	742	*
F751A227MDC	D	220	10	22.0	10	0.20	866	*
F751A337MDC	D	330	10	33.0	10	0.15	1000	*
F751A477MRC	R	470	10	47.0	14	0.12	1443	*
F751A477MUCAQ2	U	470	10	94.0	30	0.15	856	±20
16 Volt								
F751C686MCC	C	68	16	10.9	10	0.22	707	*
F751C107MCC	C	100	16	16.0	10	0.22	707	*
F751C157MDC	D	150	16	24.0	10	0.22	826	*
F751C227MRC	R	220	16	35.2	10	0.20	1118	*

* In case of capacitance tolerance ± 10% type, "K" will be put at 9th digit of type numbering system

1: ΔC/C Marked ""

Item	F75 All Case (%)
Damp Heat	±10
Temperature cycles	±5
Resistance soldering heat	±5
Surge	±5
Endurance	±10

QUALIFICATION TABLE

TEST	F72/F75 series (Temperature range -55°C to +125°C)	
	Condition	
Damp Heat (Steady State)	At 40°C, 90 to 95% R.H., 500 hours (No voltage applied) Capacitance Change Refer to page 139 (*1) Dissipation Factor Initial specified value or less Leakage Current Initial specified value or less	
Temperature Cycles	At -55°C / +125°C, 30 minutes each, 5 cycles Capacitance Change Refer to page 139 (*1) Dissipation Factor Initial specified value or less Leakage Current Initial specified value or less	
Resistance to Soldering Heat	10 seconds reflow at 260°C, 10 seconds immersion at 260°C. Capacitance Change Refer to page 139 (*1) Dissipation Factor Initial specified value or less Leakage Current Initial specified value or less	
Surge	After application of surge voltage in series with a 33Ω resistor at the rate of 30 seconds ON, 30 seconds OFF, for 1000 successive test cycles at 85°C, capacitors shall meet the characteristic requirements in the table above. Capacitance Change Refer to page 139 (*1) Dissipation Factor Initial specified value or less Leakage Current Initial specified value or less	
Endurance	After 2000 hours' application of rated voltage at 85°C, capacitors shall meet the characteristic requirements in the table above. Capacitance Change Refer to page 139 (*1) Dissipation Factor Initial specified value or less Leakage Current Initial specified value or less	
Shear Test	After applying the pressure load of 5N for 10±1 seconds horizontally to the center of capacitor side body which has no electrode and has been soldered beforehand on a substrate, there shall be found neither exfoliation nor its sign at the terminal electrode.	<p>5N (0.51kg·f) For 10±1 seconds</p>
Terminal Strength	Keeping a capacitor surface-mounted on a substrate upside down and supporting the substrate at both of the opposite bottom points 45mm apart from the center of capacitor, the pressure strength is applied with a specified jig at the center of substrate so that the substrate may bend by 1mm as illustrated. Then, there shall be found no remarkable abnormality on the capacitor terminals.	<p>R230 20 45 45 1mm</p>

OxiCap® NOJ Series



Standard and Low Profile Niobium Oxide Capacitors

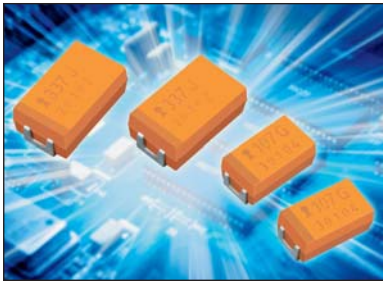

FEATURES

- Non-burn safe technology
- Reliability level: 0.5%/1000 hours at 85°C
- 13 case sizes available, standard and low profile
- Environmentally friendly, RoHS Compliant
- CV range: 2.2-1000µF / 1.8-10V
- Elektra Component of the Year Award, 2005



Elektra Award
2005

APPLICATIONS

- Automotive, Avionics, Digital, FPGA, Industrial low voltage control circuits
- Downsized industrial and automotive DC/DC converters

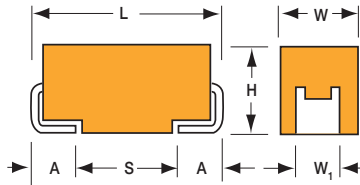

MARKING

A, B, C, D, E, F, S, T, V, W, X, Y
CASE

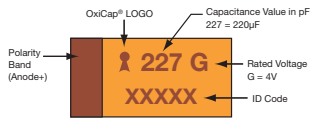

P CASE

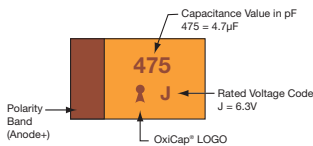

STANDARD CASE DIMENSIONS: millimeters (inches)

Code	EIA Code	EIA Metric	L±0.20 (0.008)	W+0.20 (0.008) -0.10 (0.004)	H+0.20 (0.008) -0.10 (0.004)	W ₁ ±0.20 (0.008)	A+0.30 (0.012) -0.20 (0.008)	S Min.
A	1206	3216-18	3.20 (0.126)	1.60 (0.063)	1.60 (0.063)	1.20 (0.047)	0.80 (0.031)	1.10 (0.043)
B	1210	3528-21	3.50 (0.138)	2.80 (0.110)	1.90 (0.075)	2.20 (0.087)	0.80 (0.031)	1.40 (0.055)
C	2312	6032-28	6.00 (0.236)	3.20 (0.126)	2.60 (0.102)	2.20 (0.087)	1.30 (0.051)	2.90 (0.114)
D	2917	7343-31	7.30 (0.287)	4.30 (0.169)	2.90 (0.114)	2.40 (0.094)	1.30 (0.051)	4.40 (0.173)
E	2917	7343-43	7.30 (0.287)	4.30 (0.169)	4.10 (0.162)	2.40 (0.094)	1.30 (0.051)	4.40 (0.173)
V	2924	7361-38	7.30 (0.287)	6.10 (0.240)	3.55 (0.140)	3.10 (0.120)	1.30 (0.051)	4.40 (0.173)

W₁ dimension applies to the termination width for A dimensional area only.

LOW PROFILE CASE DIMENSIONS: millimeters (inches)

Code	EIA Code	EIA Metric	L±0.20 (0.008)	W+0.20 (0.008) -0.10 (0.004)	H Max	W ₁ ±0.20 (0.008)	A+0.30 (0.012) -0.20 (0.008)	S Min.
F	2312	6032-20	6.00 (0.236)	3.20 (0.126)	2.00 (0.079)	2.20 (0.087)	1.30 (0.051)	2.90 (0.114)
P	0805	2012-15	2.05 (0.081)	1.35 (0.053)	1.50 (0.059)	1.00±0.10 (0.039±0.004)	0.50 (0.020)	0.85 (0.033)
S	1206	3216-12	3.20 (0.126)	1.60 (0.063)	1.20 (0.047)	1.20 (0.047)	0.80 (0.031)	1.10 (0.043)
T	1210	3528-12	3.50 (0.138)	2.80 (0.110)	1.20 (0.047)	2.20 (0.087)	0.80 (0.031)	1.40 (0.055)
W	2312	6032-15	6.00 (0.236)	3.20 (0.126)	1.50 (0.059)	2.20 (0.087)	1.30 (0.051)	2.90 (0.114)
X	2917	7343-15	7.30 (0.287)	4.30 (0.169)	1.50 (0.059)	2.40 (0.094)	1.30 (0.051)	4.40 (0.173)
Y	2917	7343-20	7.30 (0.287)	4.30 (0.169)	2.00 (0.079)	2.40 (0.094)	1.30 (0.051)	4.40 (0.173)

W₁ dimension applies to the termination width for A dimensional area only.
Pad Stand-off is 0.1±0.1.

HOW TO ORDER

NOJ	D	107	M	006	R	WJ	-
Type	Case Size See tables above	Capacitance Code 1st two digits represent significant figures, 3rd digit represents multiplier in pF	Tolerance M=±20%	Rated DC Voltage 001 = 1.8Vdc 002 = 2.5Vdc 004 = 4Vdc 006 = 6.3Vdc 010 = 10Vdc	Packaging R = Pure Tin 7" Reel S = Pure Tin 13" Reel	Specification Suffix WJ = Standard WB = Low ESR	Additional characters may be added for special requirements V = dry pack option (selected ratings only - dry pack is standard for all D, E, V, X, Y case size ratings)

TECHNICAL SPECIFICATIONS

Technical Data:	All technical data relate to an ambient temperature of +25°C is not stated						
Capacitance Range:	2.2 µF to 1000 µF						
Capacitance Tolerance:	±20%						
Leakage Current DCL:	0.02CV or 1.0µA whichever is the greater						
Rated Voltage DC (V _R)	≤ +85°C:	1.8	2.5	4	6.3	10	
Category Voltage (V _C)	≤ +105°C:	1.2	1.7	2.7	4	7	
Surge Voltage (V _S)	≤ +85°C:	2.3	3.3	5.2	8	13	
Surge Voltage (V _S)	≤ +105°C:	1.6	2.2	3.4	5	8	
Temperature Range:	-55°C to +105°C						
Reliability:	0.5% per 1000 hours at 85°C, V _R , 0.1Ω/V series impedance, 60% confidence level Meets requirements of AEC-Q200						

Standard and Low Profile Niobium Oxide Capacitors

STANDARD NIOBIUM OXIDE CAPACITANCE AND RATED VOLTAGE RANGE (LETTER DENOTES CASE SIZE)

Capacitance		Rated Voltage DC (V _R) to 85°C				
µF	Code	1.8V (x)	2.5V (e)	4V (G)	6.3V (J)	10V (A)
4.7	475				A	A
6.8	685				A	A
10	106				A	A/B
15	156			A	A/B	A/B
22	226		A	A/B	A/B	B/C/B(700)
33	336		A/B	A/B	B/C/B(700)	C
47	476	A	A/B	A/B/C	B/C	C
68	686	B	B/C	B/C	B/C	C
100	107	B/C	B/C	B/C/B(250)	B/C/D/B(400)	D/D(150)
150	157	C	C	C/D	C/D	
220	227	C	C	C/D	C/D/E	
330	337	C	C/D	D	D/E	
470	477		D/E	D/E	E/V/E(75)	
680	687		E	E/V		
1000	108		V	V		

LOW PROFILE NIOBIUM OXIDE CAPACITANCE AND RATED VOLTAGE RANGE (LETTER DENOTES CASE SIZE)

Capacitance		Rated Voltage DC (V _R) to 85°C				
µF	Code	1.8V (x)	2.5V (e)	4V (G)	6.3V (J)	10V (A)
1.0	105					
1.5	155					
2.2	225					P
3.3	335					P
4.7	475				P/S	T
6.8	685			P/S	P/S/T	T
10	106		P/S	P/S/T	P/T	T
15	156	P/S	P/S/T	P/T		
22	226	P/S/T	P/T	T	T	
33	336	T	T	T	W	
47	476	T	T	W	W	
68	686		W	W	X/Y	
100	107	W	W	W/X	F/Y	
150	157		X	Y	F/Y	
220	227	X	Y	F/Y	Y	
330	337	Y	Y	Y		
470	477	Y				

Released ratings (ESR ratings in mOhms in parentheses)

Note: Voltage ratings are minimum values. AVX reserves the right to supply higher voltage ratings in the same case size, to the same reliability standards

OxiCap® NOJ Series



Standard and Low Profile Niobium Oxide Capacitors

RATINGS & PART NUMBER REFERENCE

AVX Part No.	Case Size	Capacitance (µF)	Rated Voltage (V)	Rated Temperature (°C)	Category Voltage (V)	Category Temperature (°C)	DCL Max. (µA)	DF Max. (%)	ESR Max. @ 100kHz (Ω)	MSL	100kHz RMS Current (A)		
											25°C	85°C	105°C
1.8 Volt @ 85°C													
NOJP156M001#WJ	P	15	1.8	85	1.2	105	1.0	10	4.1	1	0.133	0.119	0.053
NOJS156M001#WJ	S	15	1.8	85	1.2	105	1.0	6	2	1	0.197	0.178	0.079
NOJP226M001#WJ	P	22	1.8	85	1.2	105	1.0	10	3.8	1	0.138	0.124	0.055
NOJS226M001#WJ	S	22	1.8	85	1.2	105	1.0	8	1.9	1	0.203	0.182	0.081
NOJT226M001#WJ	T	22	1.8	85	1.2	105	1.0	6	1.8	1	0.231	0.208	0.092
NOJT336M001#WJ	T	33	1.8	85	1.2	105	1.2	6	1.7	1	0.238	0.214	0.095
NOJA476M001#WJ	A	47	1.8	85	1.2	105	1.7	8	1.6	1	0.237	0.213	0.095
NOJB476M001#WJ	B	47	1.8	85	1.2	105	1.7	6	1.6	1	0.252	0.227	0.101
NOJT476M001#WJ	T	47	1.8	85	1.2	105	1.7	10	1.6	1	0.245	0.220	0.098
NOJB686M001#WJ	B	68	1.8	85	1.2	105	2.5	6	1.5	1	0.261	0.235	0.104
NOJB107M001#WJ	B	100	1.8	85	1.2	105	3.6	6	1.4	1	0.270	0.243	0.108
NOJC107M001#WJ	C	100	1.8	85	1.2	105	3.6	6	0.4	1	0.574	0.517	0.230
NOJW107M001#WJ	W	100	1.8	85	1.2	105	3.6	6	0.4	1	0.520	0.468	0.208
NOJC157M001#WJ	C	150	1.8	85	1.2	105	5.4	8	0.4	1	0.574	0.517	0.230
NOJC227M001#WJ	C	220	1.8	85	1.2	105	8.0	8	0.4	1	0.574	0.517	0.230
NOJX227M001#WJ	X	220	1.8	85	1.2	105	8.0	8	0.4	3	0.548	0.493	0.219
NOJC337M001#WJ	C	330	1.8	85	1.2	105	11.9	8	0.3	1	0.663	0.597	0.265
NOJY337M001#WJ	Y	330	1.8	85	1.2	105	11.9	8	0.3	3	0.707	0.636	0.283
NOJY477M001#WJ	Y	470	1.8	85	1.2	105	17.0	8	0.3	3	0.707	0.636	0.283
2.5 Volt @ 85°C													
NOJP106M002#WJ	P	10	2.5	85	1.7	105	1.0	6	4.5	1	0.126	0.114	0.051
NOJS106M002#WJ	S	10	2.5	85	1.7	105	1.0	6	2.2	1	0.188	0.169	0.075
NOJP156M002#WJ	P	15	2.5	85	1.7	105	1.0	6	4	1	0.134	0.121	0.054
NOJS156M002#WJ	S	15	2.5	85	1.7	105	1.0	8	2	1	0.197	0.178	0.079
NOJT156M002#WJ	T	15	2.5	85	1.7	105	1.0	6	2	1	0.219	0.197	0.088
NOJA226M002#WJ	A	22	2.5	85	1.7	105	1.1	6	1.9	1	0.218	0.196	0.087
NOJP226M002#WJ	P	22	2.5	85	1.7	105	1.1	10	3.8	1	0.138	0.124	0.055
NOJT226M002#WJ	T	22	2.5	85	1.7	105	1.1	6	1.9	1	0.225	0.202	0.090
NOJA336M002#WJ	A	33	2.5	85	1.7	105	1.7	6	1.7	1	0.230	0.207	0.092
NOJB336M002#WJ	B	33	2.5	85	1.7	105	1.7	6	1.7	1	0.245	0.220	0.098
NOJT336M002#WJ	T	33	2.5	85	1.7	105	1.7	6	1.7	1	0.238	0.214	0.095
NOJA476M002#WJ	A	47	2.5	85	1.7	105	2.4	8	1.6	1	0.237	0.213	0.095
NOJB476M002#WJ	B	47	2.5	85	1.7	105	2.4	6	1.6	1	0.252	0.227	0.101
NOJT476M002#WJ	T	47	2.5	85	1.7	105	2.4	10	1.6	1	0.245	0.220	0.098
NOJB686M002#WJ	B	68	2.5	85	1.7	105	3.4	6	1.5	1	0.261	0.235	0.104
NOJC686M002#WJ	C	68	2.5	85	1.7	105	3.4	6	0.5	1	0.514	0.462	0.206
NOJW686M002#WJ	W	68	2.5	85	1.7	105	3.4	6	0.4	1	0.520	0.468	0.208
NOJB107M002#WJ	B	100	2.5	85	1.7	105	5.0	6	1.4	1	0.270	0.243	0.108
NOJC107M002#WJ	C	100	2.5	85	1.7	105	5.0	6	0.4	1	0.574	0.517	0.230
NOJW107M002#WJ	W	100	2.5	85	1.7	105	5.0	6	0.4	1	0.520	0.468	0.208
NOJC157M002#WJ	C	150	2.5	85	1.7	105	7.5	6	0.4	1	0.574	0.517	0.230
NOJX157M002#WJ	X	150	2.5	85	1.7	105	7.5	6	0.4	3	0.548	0.493	0.219
NOJC227M002#WJ	C	220	2.5	85	1.7	105	11.0	8	0.4	1	0.574	0.517	0.230
NOJY227M002#WJ	Y	220	2.5	85	1.7	105	11.0	8	0.4	3	0.612	0.551	0.245
NOJC337M002#WJ	C	330	2.5	85	1.7	105	16.5	10	0.3	1	0.663	0.597	0.265
NOJD337M002#WJ	D	330	2.5	85	1.7	105	16.5	10	0.3	3	0.775	0.697	0.310
NOJY337M002#WJ	Y	330	2.5	85	1.7	105	16.5	10	0.3	3	0.707	0.636	0.283
NOJD477M002#WJ	D	470	2.5	85	1.7	105	23.5	12	0.3	3	0.775	0.697	0.310
NOJE477M002#WJ	E	470	2.5	85	1.7	105	23.5	10	0.3	3	0.812	0.731	0.325
NOJE687M002#WJ	E	680	2.5	85	1.7	105	34.0	14	0.3	3	0.812	0.731	0.325
NOJV108M002#WJ	V	1000	2.5	85	1.7	105	50.0	16	0.3	3	1.000	0.900	0.400
4 Volt @ 85°C													
NOJP685M004#WJ	P	6.8	4	85	2.7	105	1.0	6	5.3	1	0.117	0.105	0.047
NOJS685M004#WJ	S	6.8	4	85	2.7	105	1.0	6	2.6	1	0.173	0.156	0.069
NOJP106M004#WJ	P	10	4	85	2.7	105	1.0	20	4.5	1	0.126	0.114	0.051
NOJS106M004#WJ	S	10	4	85	2.7	105	1.0	8	2.2	1	0.188	0.169	0.075
NOJT106M004#WJ	T	10	4	85	2.7	105	1.0	6	2.2	1	0.209	0.188	0.084
NOJA156M004#WJ	A	15	4	85	2.7	105	1.2	6	2	1	0.212	0.191	0.085
NOJP156M004#WJ	P	15	4	85	2.7	105	1.2	10	4.1	1	0.133	0.119	0.053
NOJT156M004#WJ	T	15	4	85	2.7	105	1.2	6	2	1	0.219	0.197	0.088
NOJA226M004#WJ	A	22	4	85	2.7	105	1.8	6	1.9	1	0.218	0.196	0.087
NOJB226M004#WJ	B	22	4	85	2.7	105	1.8	6	1.9	1	0.232	0.209	0.093
NOJT226M004#WJ	T	22	4	85	2.7	105	1.8	6	1.8	1	0.231	0.208	0.092
NOJA336M004#WJ	A	33	4	85	2.7	105	2.6	10	1.7	1	0.230	0.207	0.092
NOJB336M004#WJ	B	33	4	85	2.7	105	2.6	6	1.7	1	0.245	0.220	0.098
NOJT336M004#WJ	T	33	4	85	2.7	105	2.6	14	2	1	0.219	0.197	0.088
NOJA476M004#WJ	A	47	4	85	2.7	105	3.8	18	2.2	1	0.202	0.182	0.081
NOJB476M004#WJ	B	47	4	85	2.7	105	3.8	6	1.6	1	0.252	0.227	0.101
NOJC476M004#WJ	C	47	4	85	2.7	105	3.8	6	0.5	1	0.514	0.462	0.206
NOJW476M004#WJ	W	47	4	85	2.7	105	3.8	6	0.5	1	0.465	0.418	0.186

OxiCap® NOJ Series



Standard and Low Profile Niobium Oxide Capacitors

RATINGS & PART NUMBER REFERENCE

AVX Part No.	Case Size	Capacitance (µF)	Rated Voltage (V)	Rated Temperature (°C)	Category Voltage (V)	Category Temperature (°C)	DCL Max. (µA)	DF Max. (%)	ESR Max. @ 100kHz (Ω)	MSL	100kHz RMS Current (A)		
											25°C	85°C	105°C
NOJB686M004#WJ	B	68	4	85	2.7	105	5.4	6	1.5	1	0.261	0.235	0.104
NOJC686M004#WJ	C	68	4	85	2.7	105	5.4	6	0.5	1	0.514	0.462	0.206
NOJW686M004#WJ	W	68	4	85	2.7	105	5.4	6	0.4	1	0.520	0.468	0.208
NOJB107M004#WJ	B	100	4	85	2.7	105	8.0	16	1.4	1	0.270	0.243	0.108
NOJB107M004#WB	B	100	4	85	2.7	105	8.0	16	0.25	3	0.639	0.575	0.255
NOJC107M004#WJ	C	100	4	85	2.7	105	8.0	6	0.4	1	0.574	0.517	0.230
NOJW107M004#WJ	W	100	4	85	2.7	105	8.0	8	0.4	1	0.520	0.468	0.208
NOJX107M004#WJ	X	100	4	85	2.7	105	8.0	6	0.4	3	0.548	0.493	0.219
NOJC157M004#WJ	C	150	4	85	2.7	105	12.0	6	0.4	1	0.574	0.517	0.230
NOJD157M004#WJ	D	150	4	85	2.7	105	12.0	6	0.3	3	0.775	0.697	0.310
NOJY157M004#WJ	Y	150	4	85	2.7	105	12.0	6	0.4	3	0.612	0.551	0.245
NOJC227M004#WJ	C	220	4	85	2.7	105	17.6	8	0.4	1	0.574	0.517	0.230
NOJD227M004#WJ	D	220	4	85	2.7	105	17.6	8	0.4	3	0.671	0.604	0.268
NOJF227M004#WJ	F	220	4	85	2.7	105	17.6	10	0.4	1	0.548	0.493	0.219
NOJY227M004#WJ	Y	220	4	85	2.7	105	17.6	10	0.4	3	0.612	0.551	0.245
NOJD337M004#WJ	D	330	4	85	2.7	105	26.4	8	0.3	3	0.775	0.697	0.310
NOJY337M004#WJ	Y	330	4	85	2.7	105	26.4	12	0.3	3	0.707	0.636	0.283
NOJD477M004#WJ	D	470	4	85	2.7	105	37.6	12	0.3	3	0.775	0.697	0.310
NOJE477M004#WJ	E	470	4	85	2.7	105	37.6	12	0.3	3	0.812	0.731	0.325
NOJE687M004#WJ	E	680	4	85	2.7	105	54.4	14	0.3	3	0.812	0.731	0.325
NOJV687M004#WJ	V	680	4	85	2.7	105	54.4	14	0.3	3	1.000	0.900	0.400
NOJV108M004#WJ	V	1000	4	85	2.7	105	80.0	18	0.3	3	1.000	0.900	0.400
6.3 Volt @ 85°C													
NOJA475M006#WJ	A	4.7	6.3	85	4	105	1.1	6	3.2	1	0.168	0.151	0.067
NOJP475M006#WJ	P	4.7	6.3	85	4	105	1.0	6	6.1	1	0.109	0.098	0.043
NOJS475M006#WJ	S	4.7	6.3	85	4	105	1.0	6	3.2	1	0.156	0.141	0.062
NOJA685M006#WJ	A	6.8	6.3	85	4	105	1.1	6	2.6	1	0.186	0.167	0.074
NOJP685M006#WJ	P	6.8	6.3	85	4	105	1.0	10	5.2	1	0.118	0.106	0.047
NOJS685M006#WJ	S	6.8	6.3	85	4	105	1.0	8	2.7	1	0.170	0.153	0.068
NOJT685M006#WJ	T	6.8	6.3	85	4	105	1.0	6	2.6	1	0.192	0.173	0.077
NOJA106M006#WJ	A	10	6.3	85	4	105	1.2	6	2.2	1	0.202	0.182	0.081
NOJP106M006#WJ	P	10	6.3	85	4	105	1.2	10	4.5	1	0.126	0.114	0.051
NOJT106M006#WJ	T	10	6.3	85	4	105	1.2	6	2.2	1	0.209	0.188	0.084
NOJA156M006#WJ	A	15	6.3	85	4	105	1.8	8	2	1	0.212	0.191	0.085
NOJB156M006#WJ	B	15	6.3	85	4	105	1.8	6	2	1	0.226	0.203	0.090
NOJA226M006#WJ	A	22	6.3	85	4	105	2.6	8	1.8	1	0.224	0.201	0.089
NOJB226M006#WJ	B	22	6.3	85	4	105	2.6	6	1.9	1	0.232	0.209	0.093
NOJT226M006#WJ	T	22	6.3	85	4	105	2.6	8	1.8	1	0.231	0.208	0.092
NOJB336M006#WJ	B	33	6.3	85	4	105	4.0	6	1.7	1	0.245	0.220	0.098
NOJB336M006#WB	B	33	6.3	85	4	105	4.0	6	0.7	3	0.382	0.344	0.153
NOJC336M006#WJ	C	33	6.3	85	4	105	4.0	6	0.5	1	0.514	0.462	0.206
NOJW336M006#WJ	W	33	6.3	85	4	105	4.0	6	0.5	1	0.465	0.418	0.186
NOJB476M006#WJ	B	47	6.3	85	4	105	5.6	6	0.8	1	0.357	0.321	0.143
NOJC476M006#WJ	C	47	6.3	85	4	105	5.7	6	0.5	1	0.514	0.462	0.206
NOJW476M006#WJ	W	47	6.3	85	4	105	5.7	6	0.5	1	0.465	0.418	0.186
NOJB686M006#WJ	B	68	6.3	85	4	105	8.2	20	1.5	1	0.261	0.235	0.104
NOJC686M006#WJ	C	68	6.3	85	4	105	8.2	6	0.5	1	0.514	0.462	0.206
NOJX686M006#WJ	X	68	6.3	85	4	105	8.2	6	0.5	3	0.490	0.441	0.196
NOJY686M006#WJ	Y	68	6.3	85	4	105	8.2	6	0.5	3	0.548	0.493	0.219
NOJB107M006#WJ	B	100	6.3	85	4	105	60.0	20	1.7	1	0.245	0.220	0.098
NOJB107M006#WB	B	100	6.3	85	4	105	60.0	20	0.4	3	0.505	0.454	0.202
NOJC107M006#WJ	C	100	6.3	85	4	105	12.0	8	0.4	1	0.574	0.517	0.230
NOJD107M006#WJ	D	100	6.3	85	4	105	12.0	6	0.4	3	0.671	0.604	0.268
NOJF107M006#WJ	F	100	6.3	85	4	105	12	8	0.4	1	0.548	0.493	0.219
NOJY107M006#WJ	Y	100	6.3	85	4	105	12.0	6	0.4	3	0.612	0.551	0.245
NOJC157M006#WJ	C	150	6.3	85	4	105	18.0	6	0.4	1	0.574	0.517	0.230
NOJD157M006#WJ	D	150	6.3	85	4	105	18.0	6	0.4	3	0.671	0.604	0.268
NOJF157M006#WJ	F	150	6.3	85	4	105	18.0	8	0.4	1	0.548	0.493	0.219
NOJY157M006#WJ	Y	150	6.3	85	4	105	18.0	6	0.4	3	0.612	0.551	0.245
NOJC227M006#WJ	C	220	6.3	85	4	105	26.4	14	0.4	1	0.574	0.517	0.230
NOJD227M006#WJ	D	220	6.3	85	4	105	26.4	8	0.4	3	0.671	0.604	0.268
NOJE227M006#WJ	E	220	6.3	85	4	105	26.4	12	0.4	3	0.704	0.633	0.281
NOJY227M006#WJ	Y	220	6.3	85	4	105	26.4	10	0.4	3	0.612	0.551	0.245
NOJD337M006#WJ	D	330	6.3	85	4	105	39.6	10	0.3	3	0.775	0.697	0.310
NOJE337M006#WJ	E	330	6.3	85	4	105	39.6	12	0.3	3	0.812	0.731	0.325
NOJE477M006#WJ	E	470	6.3	85	4	105	56.4	16	0.3	3	0.812	0.731	0.325
NOJE477M006#WB	E	470	6.3	85	4	105	56.4	16	0.075	3	1.625	1.462	0.650
NOJV477M006#WJ	V	470	6.3	85	4	105	56.4	14	0.3	3	1.000	0.900	0.400

Standard and Low Profile Niobium Oxide Capacitors

RATINGS & PART NUMBER REFERENCE

AVX Part No.	Case Size	Capacitance (µF)	Rated Voltage (V)	Rated Temperature (°C)	Category Voltage (V)	Category Temperature (°C)	DCL Max. (µA)	DF Max. (%)	ESR Max. @ 100kHz (Ω)	MSL	100kHz RMS Current (A)		
											25°C	85°C	105°C
10 Volt @ 85°C													
NOJP225M010#WJ	P	2.2	10	85	7	105	1.0	8	8.3	1	0.093	0.084	0.037
NOJP335M010#WJ	P	3.3	10	85	7	105	1.0	8	7	1	0.101	0.091	0.041
NOJA475M010#WJ	A	4.7	10	85	7	105	1.0	6	3.1	1	0.170	0.153	0.068
NOJT475M010#WJ	T	4.7	10	85	7	105	1.0	6	3.1	1	0.176	0.158	0.070
NOJA685M010#WJ	A	6.8	10	85	7	105	1.4	6	2.6	1	0.186	0.167	0.074
NOJT685M010#WJ	T	6.8	10	85	7	105	1.4	6	2.6	1	0.192	0.173	0.077
NOJA106M010#WJ	A	10	10	85	7	105	2.0	6	2.2	1	0.202	0.182	0.081
NOJB106M010#WJ	B	10	10	85	7	105	2.0	6	1	1	0.319	0.287	0.128
NOJT106M010#WJ	T	10	10	85	7	105	2.0	6	2.2	1	0.209	0.188	0.084
NOJA156M010#WJ	A	15	10	85	7	105	3.0	6	2	1	0.212	0.191	0.085
NOJB156M010#WJ	B	15	10	85	7	105	3.0	6	2	1	0.226	0.203	0.090
NOJB226M010#WJ	B	22	10	85	7	105	4.4	6	1.8	1	0.238	0.214	0.095
NOJB226M010#WB	B	22	10	85	7	105	4.4	6	0.7	3	0.382	0.344	0.153
NOJC226M010#WJ	C	22	10	85	7	105	4.4	6	0.5	1	0.514	0.462	0.206
NOJC336M010#WJ	C	33	10	85	7	105	6.6	6	0.5	1	0.514	0.462	0.206
NOJC476M010#WJ	C	47	10	85	7	105	9.4	6	0.4	1	0.574	0.517	0.230
NOJC686M010#WJ	C	68	10	85	7	105	13.6	12	0.5	1	0.514	0.462	0.206
NOJD107M010#WJ	D	100	10	85	7	105	20.0	12	0.4	3	0.671	0.604	0.268
NOJD107M010#WB	D	100	10	85	7	105	20.0	12	0.15	3	1.095	0.986	0.438

Moisture Sensitivity Level (MSL) is defined according to J-STD-020.

All technical data relates to an ambient temperature of +25°C. Capacitance and DF are measured at 120Hz, 0.5V RMS with a maximum DC bias of 2.2 volts. DCL is measured at rated voltage after 5 minutes.

The EIA & CECC standards for capacitors allow an ESR movement to 1.25 times catalog limit post mounting.

For typical weight and composition see page 222.

NOTE: AVX reserves the right to supply higher voltage ratings in the same case size, to the same reliability standards.

Standard and Low Profile Niobium Oxide Capacitors

QUALIFICATION TABLE

TEST	NOJ series (Temperature range -55°C to +105°C)										
	Condition			Characteristics							
Endurance	Apply rated voltage (UR) at 85±2°C and / or category voltage (Uc) at 105±2°C for 2000 +48/-0 hours through a circuit impedance of ≤0.1Ω/V. Stabilize at room temperature for 1-2 hours before measuring.			Visual examination	no visible damage						
				DCL	initial limit						
				ΔC/C	within ±10% of initial value						
				DF	initial limit						
				ESR	1.25 x initial limit						
Storage Life	Store at 105°C, no voltage applied, for 2000 +48/-0 hours. Stabilize at room temperature for 1-2 hours before measuring.			Visual examination	no visible damage						
				DCL	initial limit						
				ΔC/C	within ±10% of initial value						
				DF	initial limit						
				ESR	1.25 x initial limit						
Humidity	Store at 65±2°C and 95±2% relative humidity for 500 +48/-0 hours, with no applied voltage. Stabilize at room temperature and humidity for 1-2 hours before measuring.			Visual examination	no visible damage						
				DCL	1.5 x initial limit						
				ΔC/C	within ±10% of initial value						
				DF	1.2 x initial limit						
				ESR	1.25 x initial limit						
Biased Humidity	Apply rated voltage (UR) 85±2°C, at 85% relative humidity for 1000 +48/-0 hours. Stabilize at room temperature and humidity for 1-2 hours before measuring.			Visual examination	no visible damage						
				DCL	2 x initial limit						
				ΔC/C	within ±10% of initial value						
				DF	1.2 x initial limit						
				ESR	1.25 x initial limit						
Temperature Stability	Step	Temperature°C	Duration(min)		+20°C	-55°C	+20°C	+85°C	+105°C	+20°C	
	1	+20±2	15	DCL	IL*	n/a	IL*	10 x IL*	12.5 x IL*	IL*	
	2	-55+0/-3	15	ΔC/C	n/a	+0/-10%	±5%	+10/-0%	+12/-0%	±5%	
	3	+20±2	15	DF	IL*	1.5 x IL*	IL*	1.5 x IL*	2 x IL*	IL*	
	4	+85+3/-0	15	ESR	1.25 x IL*	2.5 x IL*	1.25 x IL*	1.25 x IL*	1.25 x IL*	1.25 x IL*	
	5	+105+3/-0	15								
	6	+20±2	15								
Surge Voltage	Apply 1.3x category voltage (Uc) at 105 +3/-0°C for 1,000 cycles of duration 6 mins. (30 secs. charge, 5 min. 30 sec. discharge) through a charge / discharge resistance of 1000±100Ω			Visual examination	no visible damage						
				DCL	initial limit						
				ΔC/C	within ±5% of initial value						
				DF	initial limit						
				ESR	1.25 x initial limit						
Mechanical Shock	MIL-STD-202, Method 213, Condition F			Visual examination	no visible damage						
				DCL	initial limit						
				ΔC/C	within ±5% of initial value						
				DF	initial limit						
				ESR	1.25 x initial limit						
Vibration	MIL-STD-202, Method 204, Condition D			Visual examination	no visible damage						
				DCL	initial limit						
				ΔC/C	within ±5% of initial value						
				DF	initial limit						
				ESR	1.25 x initial limit						

*Initial Limit

OxiCap® NOJ Series



Standard and Low Profile Niobium Oxide Capacitors

AVX SOLID ELECTROLYTIC CAPACITOR ROADMAP

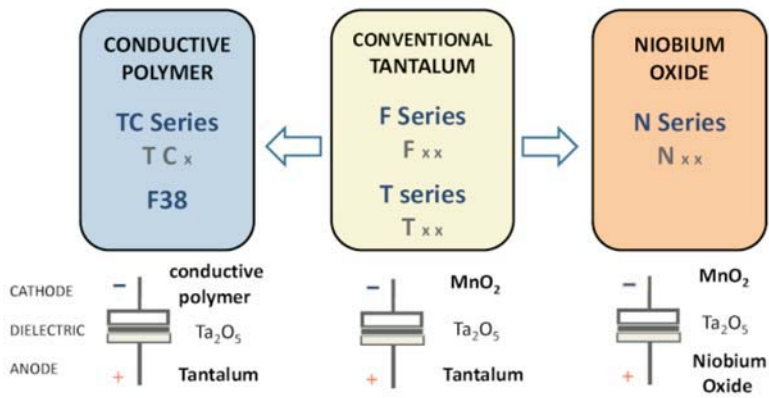

FIVE CAPACITOR CONSTRUCTION STYLES

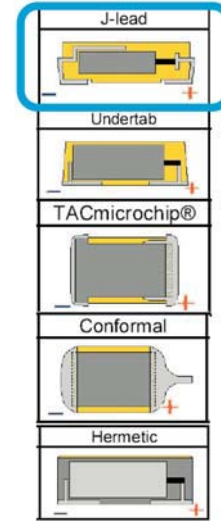

SERIES LINE UP: NIOBIUM OXIDE OxiCap® CAPACITORS

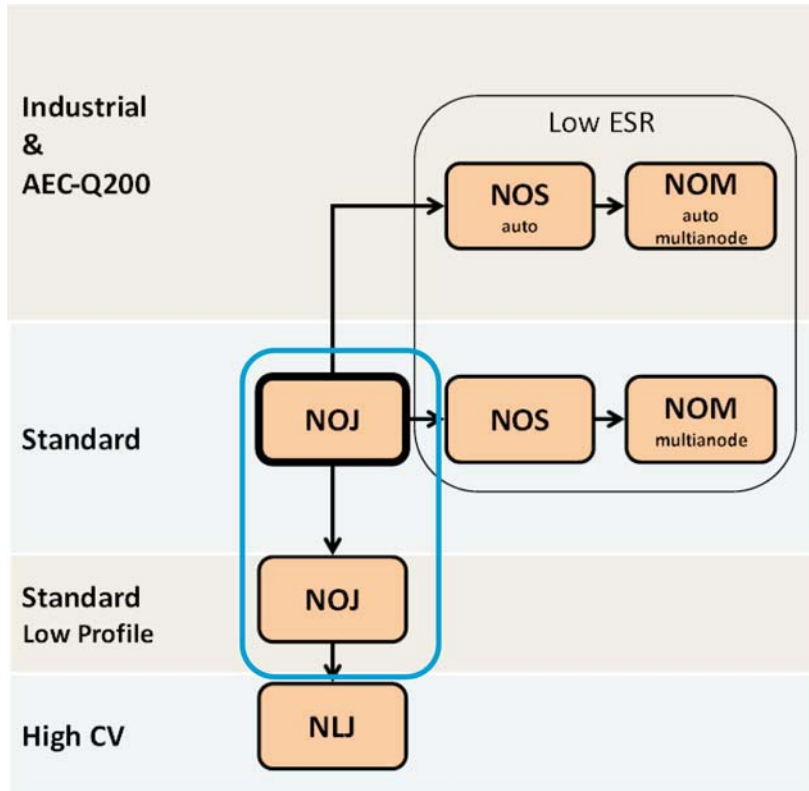

OxiCap® NLJ Series



Niobium Oxide Capacitors High CV Consumer Series



FEATURES

- High Volumetric efficiency
- Environmentally friendly
- 3xreflow 260°C compatible
- Consumer applications
- OxiCap® non-burn technology
- RoHS compliance
- Lead-free solution
- 6 case sizes available
- CV range: 22-150µF / 4-10V



Elektra Award
2005

APPLICATIONS

- Consumer handhelds and entertainment

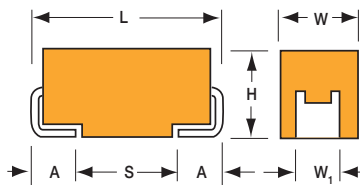

MARKING

F, S, T, W, X, Y CASE

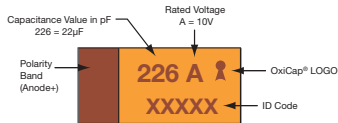

P CASE

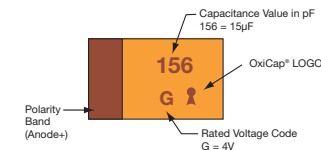

CASE DIMENSIONS: millimeters (inches)

Code	EIA Code	EIA Metric	L±0.20 (0.008)	W+0.20 (0.008) -0.10 (0.004)	H+0.20 (0.008) -0.10 (0.004)	W ₁ ±0.20 (0.008)	A+0.30 (0.012) -0.20 (0.008)	S Min.
A	1206	3216-18	3.20 (0.126)	1.60 (0.063)	1.60 (0.063)	1.20 (0.047)	0.80 (0.031)	1.10 (0.043)
B	1210	3528-21	3.50 (0.138)	2.80 (0.110)	1.90 (0.075)	2.20 (0.087)	0.80 (0.031)	1.40 (0.055)
C	2312	6032-28	6.00 (0.236)	3.20 (0.126)	2.60 (0.102)	2.20 (0.087)	1.30 (0.051)	2.90 (0.114)
D	2917	7343-31	7.30 (0.287)	4.30 (0.169)	2.90 (0.114)	2.40 (0.094)	1.30 (0.051)	4.40 (0.173)
G	1206	3216-15	3.20 (0.126)	1.60 (0.063)	1.50 (0.059) max	1.20 (0.047)	0.80 (0.031)	1.10 (0.043)
P	0805	2012-15	2.05 (0.081)	1.35 (0.053)	1.50 (0.059) max	1.00±0.10 (0.039±0.004)	0.50 (0.020)	0.85 (0.033)
S	1206	3216-12	3.20 (0.126)	1.60 (0.063)	1.20 (0.047) max	1.20 (0.047)	0.80 (0.031)	1.10 (0.043)
T	1210	3528-12	3.50 (0.138)	2.80 (0.110)	1.20 (0.047) max	2.20 (0.087)	0.80 (0.031)	1.40 (0.055)
W	2312	6032-15	6.00 (0.236)	3.20 (0.126)	1.50 (0.059) max	2.20 (0.087)	1.30 (0.051)	2.90 (0.114)
Y	2917	7343-20	7.30 (0.287)	4.30 (0.169)	2.00 (0.079) max	2.40 (0.094)	1.30 (0.051)	4.40 (0.173)

W₁ dimension applies to the termination width for A dimensional area only.

Under development

HOW TO ORDER

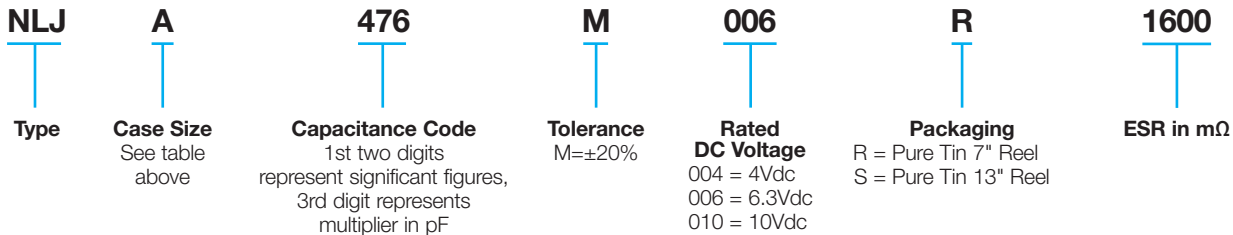

TECHNICAL SPECIFICATIONS

Technical Data:	All technical data relate to an ambient temperature of +25°C			
Capacitance Range:	6.8 µF to 1000 µF			
Capacitance Tolerance:	±20%			
Leakage Current DCL:	0.1CV			
Rated Voltage DC (V _R)	-55°C ≤ +40°C:	4	6.3	10
Category Voltage (V _C)	at 85°C:	2	3.2	5
Category Voltage (V _C)	at 105°C:	1.3	2	3.3
Temperature Range:	-55°C to +105°C with category voltage			
Reliability:	0.2% per 1000 hours at 85°C, 0.5xV _R , 0.1Ω/V series impedance with 60% confidence level			



CAPACITANCE AND RATED VOLTAGE RANGE (LETTER DENOTES CASE SIZE)

Capacitance		Rated Voltage DC to 40°C		
µF	Code	4V (G)	6.3V (J)	10V (A)
6.8	685			K(4000)*/P(5000)*
10	106		K(4000)*	K(2200)*/P(6000)*
15	156	K(4000)*/P(4000)*	P(3500)*	L(2800)*/S(2000)*
22	226	P(4000)	L(2500)*/S(1800)	A(4000)/G(3000) L(2200)*
33	336	A(3000)*/S(1700)*	G(2200)/L(2500)*	A(1700)/T(1800)*
47	476	A(2600)*/G(2600)* L(1600)*	A(1600)/T(1600)	B(1000)/H(1000)* W(400)*
68	686	A(1500)*/T(1500)*	H(900)*	B(1400)*
100	107	H(900)*	B(1700)/W(600)*	C(1200)*/Y(1200)*
150	157	B(1500)/W(400)*		
220	227			D(1000)*
330	337		C(500)*/Y(500)*	
470	477	C(500)*/Y(500)*		
680	687		D(500)*	
1000	108	D(500)*		

Available Ratings, (ESR ratings in mOhms in brackets)

Engineering samples - please contact manufacturer

*Codes under development - subject to change

Note: Voltage ratings are minimum values. AVX reserves the right to supply higher ratings in the same case size, to the same reliability standards.

RATINGS & PART NUMBER REFERENCE

AVX Part No.	Case Size	Capacitance (µF)	Rated Voltage (V)	Rated Temperature (°C)	Category Voltage (V)	Category Temperature (°C)	Maximum Surge Current (A)	DCL Max. (µA)	ESR Max. @ 100kHz (mΩ)	MSL	100kHz RMS Current (mA)		
											25°C	85°C	105°C
4 Volt @ 85°C													
NLJP226M004#4000	P	22	4	85	1.3	105	0.4	8.8	4000	3	134	121	54
NLJB157M004#1500	B	150	4	85	1.3	105	1.0	60.0	1500	3	261	235	104
6.3 Volt @ 85°C													
NLJS226M006#1800	S	22	6.3	85	2	105	1.4	13.2	1800	3	208	187	83
NLJG336M006#2200	G	33	6.3	85	2	105	1.2	19.8	2200	3	195	176	78
NLJA476M006#1600	A	47	6.3	85	2	105	1.5	28.2	1600	3	237	213	98
NLJT476M006#1600	T	47	6.3	85	2	105	1.5	28.2	1600	3	245	220	98
NLJB107M006#1700	B	100	6.3	85	2	105	1.5	60.0	1700	3	245	220	98
10 Volt @ 85°C													
NLJA226M010#4000	A	22	10	85	3.3	105	1.1	22.0	4000	3	150	135	60
NLJG226M010#3000	G	22	10	85	3.3	105	1.4	22.0	3000	3	167	151	67
NLJA336M010#1700	A	33	10	85	3.3	105	2.3	33.0	1700	3	230	207	92
NLJB476M010#1000	B	47	10	85	3.3	105	3.4	47.0	1000	3	319	287	128

Moisture Sensitivity Level (MSL) is defined according to J-STD-020.

All technical data relates to an ambient temperature of +25°C. Capacitance and DF are measured at 120Hz, 0.5V RMS with a maximum DC bias of 2.2 volts. DCL is measured at rated voltage after 5 minutes.

ESR allowed to move up to 1.25 times catalogue limit post mounting

DCL allowed to move up to 2.00 times catalogue limit post mounting

For typical weight and composition see page 222.

NOTE: AVX reserves the right to supply a higher voltage rating or tighter tolerance part in the same case size, to the same reliability standards.

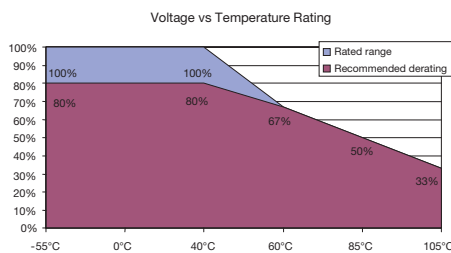

QUALIFICATION TABLE

TEST	NLJ series (Temperature range -55°C to +105°C)										
	Condition			Characteristics							
Endurance	Determine after application of rated voltage for 2000 +48/-0 hours at 40±2°C and then leaving 1-2 hours at room temperature. Also determine of 85°C temperature, category voltage for 2000 +48/-0 hours and then leaving 1-2 hours at room temperature. Power supply impedance to be ≤0.1Ω/V.			Visual examination	no visible damage						
				DCL	2 x initial limit						
				ΔC/C	within ±10% of initial value						
				ESR	1.25 x initial limit						
Humidity	Determine after storage without applied voltage at 65±2°C and 90-95±2% relative humidity for 500hrs and then recovery 1-2 hours at room temperature.			Visual examination	no visible damage						
				DCL	2 x initial limit						
				ΔC/C	within ±10% of initial value						
				ESR	1.25 x initial limit						
Temperature Stability	Step	Temperature°C	Duration(min)		+20°C	-55°C	+20°C	+85°C	+105°C	+20°C	
	1	+20±2	15	DCL	2 x IL*	n/a	2 x IL**	10 x IL*	12.5 x IL*	2 x IL*	
	2	-55+0/-3	15		ΔC/C	n/a	+0/-20%	±5%	+20/-0%	+25/-0%	±5%
	3	+20±2	15	ESR		1.25 x IL*	2.5 x IL*	1.25 x IL*	1.25 x IL*	1.25 x IL*	1.25 x IL*
	4	+85+3/-0	15								
	5	+105+3/-0	15								
	6	+20±2	15								
Surge Voltage	Test temperature: 40°C±3/0°C Test voltage: 1.3 x rated voltage Series protection resistance 1000±100Ω Discharge resistance: 1000Ω Number of cycles: 1000x Cycle duration: 6 min; 30 sec charge, 5 min 30 sec discharge			Visual examination	no visible damage						
				DCL	2 x initial limit						
				ΔC/C	within ±5% of initial value						
				ESR	1.25 x initial limit						

*Initial Limit

OxiCap® NOS Low ESR Series



Niobium Oxide Capacitor



FEATURES

- Low ESR NbO capacitors
- Non-burn safe technology
- Reliability level: 0.2%/1000 hrs.
- CV range: 10-1000µF / 1.8-8V
- 9 case sizes available
- IBM global approval received in 2004
- Elektra Award received in 2005
- Meets requirements of AEC-Q200
- -55 to +125°C operation temperature

APPLICATIONS

- Medium power DC/DC for transportation and automotive industry



LEAD-FREE
LEAD-FREE COMPATIBLE
COMPONENT



RoHS
COMPLIANT



NON-BURN
NON-SMOKE



Elektra Award
2005

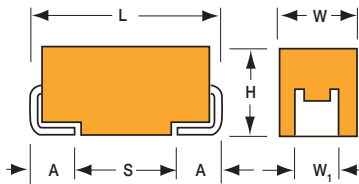

CASE DIMENSIONS: millimeters (inches)

Code	EIA Code	EIA Metric	L±0.20 (0.008)	W+0.20 (0.008) -0.10 (0.004)	H+0.20 (0.008) -0.10 (0.004)	W ₁ ±0.20 (0.008)	A+0.30 (0.012) -0.20 (0.008)	S Min.
A	1206	3216-18	3.20 (0.126)	1.60 (0.063)	1.60 (0.063)	1.20 (0.047)	0.80 (0.031)	1.10 (0.043)
B	1210	3528-21	3.50 (0.138)	2.80 (0.110)	1.90 (0.075)	2.20 (0.087)	0.80 (0.031)	1.40 (0.055)
C	2312	6032-28	6.00 (0.236)	3.20 (0.126)	2.60 (0.102)	2.20 (0.087)	1.30 (0.051)	2.90 (0.114)
D	2917	7343-31	7.30 (0.287)	4.30 (0.169)	2.90 (0.114)	2.40 (0.094)	1.30 (0.051)	4.40 (0.173)
E	2917	7343-43	7.30 (0.287)	4.30 (0.169)	4.10 (0.162)	2.40 (0.094)	1.30 (0.051)	4.40 (0.173)
V	2924	7361-38	7.30 (0.287)	6.10 (0.240)	3.55 (0.140)	3.10 (0.120)	1.30 (0.051)	4.40 (0.173)
W	2312	6032-15	6.00 (0.236)	3.20 (0.126)	1.50 (0.059) max.	2.20 (0.087)	1.30 (0.051)	2.90 (0.114)
X	2917	7343-15	7.30 (0.287)	4.30 (0.169)	1.50 (0.059) max.	2.40 (0.094)	1.30 (0.051)	4.40 (0.173)
Y	2917	7343-20	7.30 (0.287)	4.30 (0.169)	2.00 (0.079) max.	2.40 (0.094)	1.30 (0.051)	4.40 (0.173)

W₁ dimension applies to the termination width for A dimensional area only.

MARKING

A, B, C, D, E, V, W, X, Y CASE

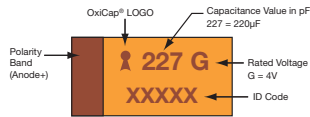

HOW TO ORDER

NOS	D	107	M	006	R	0100	-
Type	Case Size See table above	Capacitance Code 1st two digits represent significant figures, 3rd digit represents multiplier in pF	Tolerance M=±20%	Rated DC Voltage 001 = 1.8Vdc 002 = 2.5Vdc 004 = 4Vdc 006 = 6.3Vdc 008 = 8Vdc	Packaging R = Pure Tin 7" Reel S = Pure Tin 13" Reel	ESR in mΩ	Additional characters may be added for special requirements V = Dry pack Option (selected codes only) with exception of D, E, X, Y, V cases

TECHNICAL SPECIFICATIONS

Technical Data:	All technical data relate to an ambient temperature of +25°C is not stated						
Capacitance Range:	10 µF to 1000 µF						
Capacitance Tolerance:	±20%						
Leakage Current DCL:	0.02CV						
Rated Voltage DC (V _R)	≤ +85°C:	1.8	2.5	4	6.3	8	
Category Voltage (V _C)	≤ +105°C:	1.2	1.7	2.7	4	7	
Category Voltage (V _C)	≤ +125°C:	0.9	1.3	2	3	4	
Surge Voltage (V _S)	≤ +85°C:	2.3	3.3	5.2	8	10	
Surge Voltage (V _S)	≤ +105°C:	1.6	2.2	3.4	5	8	
Surge Voltage (V _S)	≤ +125°C:	1.2	1.7	2.6	4	5.3	
Temperature Range:	-55°C to +125°C						
Reliability:	0.2% per 1000 hours at 85°C, V _R , 0.1Ω/V series impedance, 60% confidence level Meets requirements of AEC-Q200						

OxiCap® NOS Low ESR Series



Niobium Oxide Capacitor

CAPACITANCE AND RATED VOLTAGE RANGE (LETTER DENOTES CASE SIZE)

Capacitance		Rated Voltage DC (V _R) to 85°C				
µF	Code	1.8V (x)	2.5V (e)	4.0V (G)	6.3V (J)	8V (P)
10	106				A(800,1000,2000,2200)	A(2200) B(1000)
15	156			A(1500,2000)	B(600,2000)	B(2000)
22	226		A(900,1900)	B(600,1900)	B(600,1900)	B(700,1800) C(500)
33	336		B(1700)	B(600,1700)	B(600,1700) C(500) W(250,500)	C(500)
47	476		B(500,1600)	B(500,1600) C(300,500) W(150,500)	B(500,800) C(300,500)	C(400)
68	686		C(200,500) W(150,400)	C(200,500)	C(75,200,500) X(100,500) Y(100,500)	C(500)
100	107	B(350,1400) W(150,400)	C(150,400)	C(70,150,400) X(100,400)	C(150,400) D(80,100,400) Y(100,400)	D(400)
150	157	C(400)	C(65,150,400) X(100,400)	C(90,150,400) Y(100,400)	D(50,70,100,400) Y(100,400)	
220	227	C(125,400) X(100,400)	C(80,125,400) Y(100,400)	D(40,60,100,400) Y(100,400)	D(45,60,100,400) E(80,100,400)	
330	337	Y(100,300)	D(35,50,100,300) Y(100,300)	D(35,55,100,300) E(100) Y(150,300)	E(80,100,300)	
470	477	Y(100,300)	D(35,55,100,300) E(100,300)	D(100,300) E(75,100,300)	V(75,300)	
680	687		E(60,300)	V(75,300)		
1000	108		V(50,300)			

Released ratings (ESR ratings in mOhms in parenthesis)

Engineering samples – please contact AVX

*Ratings under development – subject to change

Note: Voltage ratings are minimum values. AVX reserves the right to supply higher ratings in the same case size, to the same reliability standards.

OxiCap® NOS Low ESR Series



Niobium Oxide Capacitor

RATINGS & PART NUMBER REFERENCE

AVX Part No.	Case Size	Capacitance (µF)	Rated Voltage (V)	Rated Temperature (°C)	Category Voltage (V)	Category Temperature (°C)	DCL Max. (µA)	DF Max. (%)	ESR Max. @ 100kHz (mΩ)	MSL	100kHz RMS Current (A)		
											25°C	85°C	125°C
1.8 Volt @ 85°C													
NOSB107M001#0350	B	100	1.8	85	0.9	125	3.6	6	350	1	0.540	0.486	0.216
NOSB107M001#1400	B	100	1.8	85	0.9	125	3.6	6	1400	1	0.270	0.243	0.108
NOSW107M001#0150	W	100	1.8	85	0.9	125	3.6	6	150	1	0.849	0.764	0.339
NOSW107M001#0400	W	100	1.8	85	0.9	125	3.6	6	400	1	0.520	0.468	0.208
NOSC157M001#0400	C	150	1.8	85	0.9	125	5.4	8	400	1	0.574	0.517	0.230
NOSC227M001#0125	C	220	1.8	85	0.9	125	8.0	8	125	1	1.028	0.925	0.411
NOSC227M001#0400	C	220	1.8	85	0.9	125	8.0	8	400	1	0.574	0.517	0.230
NOSX227M001#0100	X	220	1.8	85	0.9	125	8.0	8	100	3	1.095	0.986	0.438
NOSX227M001#0400	X	220	1.8	85	0.9	125	8.0	8	400	3	0.548	0.493	0.219
NOSY337M001#0100	Y	330	1.8	85	0.9	125	11.9	8	100	3	1.225	1.102	0.490
NOSY337M001#0300	Y	330	1.8	85	0.9	125	11.9	8	300	3	0.707	0.636	0.283
NOSY477M001#0100	Y	470	1.8	85	0.9	125	17.0	8	100	3	1.225	1.102	0.490
NOSY477M001#0300	Y	470	1.8	85	0.9	125	17.0	8	300	3	0.707	0.636	0.283
2.5 Volt @ 85°C													
NOSA226M002#0900	A	22	2.5	85	1.3	125	1.1	6	900	1	0.316	0.285	0.126
NOSA226M002#1900	A	22	2.5	85	1.3	125	1.1	6	1900	1	0.218	0.196	0.087
NOSB336M002#1700	B	33	2.5	85	1.3	125	1.7	6	1700	1	0.245	0.220	0.098
NOSB476M002#0500	B	47	2.5	85	1.3	125	2.4	6	500	1	0.452	0.406	0.181
NOSB476M002#1600	B	47	2.5	85	1.3	125	2.4	6	1600	1	0.252	0.227	0.101
NOSC686M002#0200	C	68	2.5	85	1.3	125	3.4	6	200	1	0.812	0.731	0.325
NOSC686M002#0500	C	68	2.5	85	1.3	125	3.4	6	500	1	0.514	0.462	0.206
NOSW686M002#0150	W	68	2.5	85	1.3	125	3.4	6	150	1	0.849	0.764	0.339
NOSW686M002#0400	W	68	2.5	85	1.3	125	3.4	6	400	1	0.520	0.468	0.208
NOSC107M002#0150	C	100	2.5	85	1.3	125	5.0	6	150	1	0.938	0.844	0.375
NOSC107M002#0400	C	100	2.5	85	1.3	125	5.0	6	400	1	0.574	0.517	0.230
NOSC157M002#0065	C	150	2.5	85	1.3	125	7.5	6	65	1	1.425	1.283	0.570
NOSC157M002#0150	C	150	2.5	85	1.3	125	7.5	6	150	1	0.938	0.844	0.375
NOSC157M002#0400	C	150	2.5	85	1.3	125	7.5	6	400	1	0.574	0.517	0.230
NOSX157M002#0100	X	150	2.5	85	1.3	125	7.5	6	100	3	1.095	0.986	0.438
NOSX157M002#0400	X	150	2.5	85	1.3	125	7.5	6	400	3	0.548	0.493	0.219
NOSC227M002#0080	C	220	2.5	85	1.3	125	11.0	8	80	1	1.285	1.156	0.514
NOSC227M002#0125	C	220	2.5	85	1.3	125	11.0	8	125	1	1.028	0.925	0.411
NOSC227M002#0400	C	220	2.5	85	1.3	125	11.0	8	400	1	0.574	0.517	0.230
NOSY227M002#0100	Y	220	2.5	85	1.3	125	11.0	8	100	3	1.225	1.102	0.490
NOSY227M002#0400	Y	220	2.5	85	1.3	125	11.0	8	400	3	0.612	0.551	0.245
NOSD337M002#0035	D	330	2.5	85	1.3	125	16.5	10	35	3	2.268	2.041	0.907
NOSD337M002#0050	D	330	2.5	85	1.3	125	16.5	10	50	3	1.897	1.708	0.759
NOSD337M002#0100	D	330	2.5	85	1.3	125	16.5	10	100	3	1.342	1.207	0.537
NOSD337M002#0300	D	330	2.5	85	1.3	125	16.5	10	300	3	0.775	0.697	0.310
NOSY337M002#0100	Y	330	2.5	85	1.3	125	16.5	10	100	3	1.225	1.102	0.490
NOSY337M002#0300	Y	330	2.5	85	1.3	125	16.5	10	300	3	0.707	0.636	0.283
NOSD477M002#0035	D	470	2.5	85	1.3	125	23.5	12	35	3	2.268	2.041	0.907
NOSD477M002#0055	D	470	2.5	85	1.3	125	23.5	12	55	3	1.809	1.628	0.724
NOSD477M002#0100	D	470	2.5	85	1.3	125	23.5	12	100	3	1.342	1.207	0.537
NOSD477M002#0300	D	470	2.5	85	1.3	125	23.5	12	300	3	0.775	0.697	0.310
NOSE477M002#0100	E	470	2.5	85	1.3	125	23.5	10	100	3	1.407	1.266	0.563
NOSE477M002#0300	E	470	2.5	85	1.3	125	23.5	10	300	3	0.812	0.731	0.325
NOSE687M002#0060	E	680	2.5	85	1.3	125	34.0	14	60	3	1.817	1.635	0.727
NOSE687M002#0300	E	680	2.5	85	1.3	125	34.0	14	300	3	0.812	0.731	0.325
NOSV108M002#0050	V	1000	2.5	85	1.3	125	50.0	16	50	3	2.449	2.205	0.980
NOSV108M002#0300	V	1000	2.5	85	1.3	125	50.0	16	300	3	1.000	0.900	0.400
4 Volt @ 85°C													
NOSA156M004#1500	A	15	4	85	2	125	1.2	6	1500	1	0.245	0.220	0.098
NOSA156M004#2000	A	15	4	85	2	125	1.2	6	2000	1	0.212	0.191	0.085
NOSB226M004#0600	B	22	4	85	2	125	1.8	6	600	1	0.412	0.371	0.165
NOSB226M004#1900	B	22	4	85	2	125	1.8	6	1900	1	0.232	0.209	0.093
NOSB336M004#0600	B	33	4	85	2	125	2.6	6	600	1	0.412	0.371	0.165
NOSB336M004#1700	B	33	4	85	2	125	2.6	6	1700	1	0.245	0.220	0.098
NOSB476M004#0500	B	47	4	85	2	125	3.8	6	500	1	0.452	0.406	0.181
NOSB476M004#1600	B	47	4	85	2	125	3.8	6	1600	1	0.252	0.227	0.101
NOSC476M004#0300	C	47	4	85	2	125	3.8	6	300	1	0.663	0.597	0.265
NOSC476M004#0500	C	47	4	85	2	125	3.8	6	500	1	0.514	0.462	0.206
NOSW476M004#0150	W	47	4	85	2	125	3.8	6	150	1	0.849	0.764	0.339
NOSW476M004#0500	W	47	4	85	2	125	3.8	6	500	1	0.465	0.418	0.186
NOSC686M004#0200	C	68	4	85	2	125	5.4	6	200	1	0.812	0.731	0.325
NOSC686M004#0500	C	68	4	85	2	125	5.4	6	500	1	0.514	0.462	0.206
NOSC107M004#0070	C	100	4	85	2	125	8.0	6	70	1	1.373	1.236	0.549
NOSC107M004#0150	C	100	4	85	2	125	8.0	6	150	1	0.938	0.844	0.375
NOSC107M004#0400	C	100	4	85	2	125	8.0	6	400	1	0.574	0.517	0.230
NOSX107M004#0100	X	100	4	85	2	125	8.0	6	100	3	1.095	0.986	0.438

OxiCap® NOS Low ESR Series



Niobium Oxide Capacitor

RATINGS & PART NUMBER REFERENCE

AVX Part No.	Case Size	Capacitance (µF)	Rated Voltage (V)	Rated Temperature (°C)	Category Voltage (V)	Category Temperature (°C)	DCL Max. (µA)	DF Max. (%)	ESR Max. @ 100kHz (mΩ)	MSL	100kHz RMS Current (A)		
											25°C	85°C	125°C
NOSX107M004#0400	X	100	4	85	2	125	8.0	6	400	3	0.548	0.493	0.219
NOSC157M004#0090	C	150	4	85	2	125	12.0	6	90	1	1.211	1.090	0.484
NOSC157M004#0150	C	150	4	85	2	125	12.0	6	150	1	0.938	0.844	0.375
NOSC157M004#0400	C	150	4	85	2	125	12.0	6	400	1	0.574	0.517	0.230
NOSY157M004#0100	Y	150	4	85	2	125	12.0	6	100	3	1.225	1.102	0.490
NOSY157M004#0400	Y	150	4	85	2	125	12.0	6	400	3	0.612	0.551	0.245
NOSD227M004#0040	D	220	4	85	2	125	17.6	8	40	3	2.121	1.909	0.849
NOSD227M004#0060	D	220	4	85	2	125	17.6	8	60	3	1.732	1.559	0.693
NOSD227M004#0100	D	220	4	85	2	125	17.6	8	100	3	1.342	1.207	0.537
NOSD227M004#0400	D	220	4	85	2	125	17.6	8	400	3	0.671	0.604	0.268
NOSY227M004#0100	Y	220	4	85	2	125	17.6	10	100	3	1.225	1.102	0.490
NOSY227M004#0400	Y	220	4	85	2	125	17.6	10	400	3	0.612	0.551	0.245
NOSD337M004#0035	D	330	4	85	2	125	26.4	8	35	3	2.268	2.041	0.907
NOSD337M004#0055	D	330	4	85	2	125	26.4	8	55	3	1.809	1.628	0.724
NOSD337M004#0100	D	330	4	85	2	125	26.4	8	100	3	1.342	1.207	0.537
NOSD337M004#0300	D	330	4	85	2	125	26.4	8	300	3	0.775	0.697	0.310
NOSE337M004#0100	E	330	4	85	2	125	26.4	8	100	3	1.407	1.266	0.563
NOSY337M004#0150	Y	330	4	85	2	125	26.4	12	150	3	1.000	0.900	0.400
NOSY337M004#0300	Y	330	4	85	2	125	26.4	12	300	3	0.707	0.636	0.283
NOSD477M004#0100	D	470	4	85	2	125	37.6	12	100	3	1.342	1.207	0.537
NOSD477M004#0300	D	470	4	85	2	125	37.6	12	300	3	0.775	0.697	0.310
NOSE477M004#0075	E	470	4	85	2	125	37.6	12	75	3	1.625	1.462	0.650
NOSE477M004#0100	E	470	4	85	2	125	37.6	12	100	3	1.407	1.266	0.563
NOSE477M004#0300	E	470	4	85	2	125	37.6	12	300	3	0.812	0.731	0.325
NOSV687M004#0075	V	680	4	85	2	125	54.4	14	75	3	2.000	1.800	0.800
NOSV687M004#0300	V	680	4	85	2	125	54.4	14	300	3	1.000	0.900	0.400
6.3 Volt @ 85°C													
NOSA106M006#0800	A	10	6.3	85	3	125	1.2	6	800	1	0.335	0.302	0.134
NOSA106M006#1000	A	10	6.3	85	3	125	1.2	6	1000	1	0.300	0.270	0.120
NOSA106M006#2000	A	10	6.3	85	3	125	1.2	6	2000	1	0.212	0.191	0.085
NOSA106M006#2200	A	10	6.3	85	3	125	1.2	6	2200	1	0.202	0.182	0.081
NOSB156M006#0600	B	15	6.3	85	3	125	1.8	6	600	1	0.412	0.371	0.165
NOSB156M006#2000	B	15	6.3	85	3	125	1.8	6	2000	1	0.226	0.203	0.090
NOSB226M006#0600	B	22	6.3	85	3	125	2.6	6	600	1	0.412	0.371	0.165
NOSB226M006#1900	B	22	6.3	85	3	125	2.6	6	1900	1	0.232	0.209	0.093
NOSB336M006#0600	B	33	6.3	85	3	125	4.0	6	600	1	0.412	0.371	0.165
NOSB336M006#1700	B	33	6.3	85	3	125	4.0	6	1700	1	0.245	0.220	0.098
NOSB336M006#0500	C	33	6.3	85	3	125	4.0	6	500	1	0.514	0.462	0.206
NOSW336M006#0250	W	33	6.3	85	3	125	4.0	6	250	1	0.657	0.592	0.263
NOSW336M006#0500	W	33	6.3	85	3	125	4.0	6	500	1	0.465	0.418	0.186
NOSB476M006#0500	B	47	6.3	85	3	125	5.6	6	500	1	0.452	0.406	0.181
NOSB476M006#0800	B	47	6.3	85	3	125	5.6	6	800	1	0.357	0.321	0.143
NOSC476M006#0300	C	47	6.3	85	3	125	5.7	6	300	1	0.663	0.597	0.265
NOSC476M006#0500	C	47	6.3	85	3	125	5.7	6	500	1	0.514	0.462	0.206
NOSC686M006#0075	C	68	6.3	85	3	125	8.2	6	75	1	1.327	1.194	0.531
NOSC686M006#0200	C	68	6.3	85	3	125	8.2	6	200	1	0.812	0.731	0.325
NOSC686M006#0500	C	68	6.3	85	3	125	8.2	6	500	1	0.514	0.462	0.206
NOSX686M006#0100	X	68	6.3	85	3	125	8.2	6	100	3	1.095	0.986	0.438
NOSX686M006#0500	X	68	6.3	85	3	125	8.2	6	500	3	0.490	0.441	0.196
NOSY686M006#0100	Y	68	6.3	85	3	125	8.2	6	100	3	1.225	1.102	0.490
NOSY686M006#0500	Y	68	6.3	85	3	125	8.2	6	500	3	0.548	0.493	0.219
NOSC107M006#0150	C	100	6.3	85	3	125	12.0	8	150	1	0.938	0.844	0.375
NOSC107M006#0400	C	100	6.3	85	3	125	12.0	8	400	1	0.574	0.517	0.230
NOSD107M006#0080	D	100	6.3	85	3	125	12.0	6	80	3	1.500	1.350	0.600
NOSD107M006#0100	D	100	6.3	85	3	125	12.0	6	100	3	1.342	1.207	0.537
NOSD107M006#0400	D	100	6.3	85	3	125	12.0	6	400	3	0.671	0.604	0.268
NOSY107M006#0100	Y	100	6.3	85	3	125	12.0	6	100	3	1.225	1.102	0.490
NOSY107M006#0400	Y	100	6.3	85	3	125	12.0	6	400	3	0.612	0.551	0.245
NOSD157M006#0050	D	150	6.3	85	3	125	18.0	6	50	3	1.897	1.708	0.759
NOSD157M006#0070	D	150	6.3	85	3	125	18.0	6	70	3	1.604	1.443	0.641
NOSD157M006#0100	D	150	6.3	85	3	125	18.0	6	100	3	1.342	1.207	0.537
NOSD157M006#0400	D	150	6.3	85	3	125	18.0	6	400	3	0.671	0.604	0.268
NOSY157M006#0100	Y	150	6.3	85	3	125	18.0	6	100	3	1.225	1.102	0.490
NOSY157M006#0400	Y	150	6.3	85	3	125	18.0	6	400	3	0.612	0.551	0.245
NOSD227M006#0045	D	220	6.3	85	3	125	26.4	8	45	3	2.000	1.800	0.800
NOSD227M006#0060	D	220	6.3	85	3	125	26.4	8	60	3	1.732	1.559	0.693
NOSD227M006#0100	D	220	6.3	85	3	125	26.4	8	100	3	1.342	1.207	0.537
NOSD227M006#0400	D	220	6.3	85	3	125	26.4	8	400	3	0.671	0.604	0.268
NOSE227M006#0080	E	220	6.3	85	3	125	26.4	12	80	3	1.573	1.416	0.629
NOSE227M006#0100	E	220	6.3	85	3	125	26.4	12	100	3	1.407	1.266	0.563
NOSE227M006#0400	E	220	6.3	85	3	125	26.4	12	400	3	0.704	0.633	0.281

OxiCap® NOS Low ESR Series



Niobium Oxide Capacitor

RATINGS & PART NUMBER REFERENCE

AVX Part No.	Case Size	Capacitance (µF)	Rated Voltage (V)	Rated Temperature (°C)	Category Voltage (V)	Category Temperature (°C)	DCL Max. (µA)	DF Max. (%)	ESR Max. @ 100kHz (mΩ)	MSL	100kHz RMS Current (A)		
											25°C	85°C	125°C
NOSE337M006#0080	E	330	6.3	85	3	125	39.6	12	80	3	1.573	1.416	0.629
NOSE337M006#0100	E	330	6.3	85	3	125	39.6	12	100	3	1.407	1.266	0.563
NOSE337M006#0300	E	330	6.3	85	3	125	39.6	12	300	3	0.812	0.731	0.325
NOSV477M006#0075	V	470	6.3	85	3	125	56.4	14	75	3	2.000	1.800	0.800
NOSV477M006#0300	V	470	6.3	85	3	125	56.4	14	300	3	1.000	0.900	0.400
8 Volt @ 85°C													
NOSA106M008#2200	A	10	8	85	4	125	1.6	10	2200	1	0.202	0.182	0.081
NOSB106M008#1000	B	10	8	85	4	125	1.6	10	1000	1	0.319	0.287	0.128
NOSB156M008#2000	B	15	8	85	4	125	2.4	10	2000	1	0.226	0.203	0.090
NOSB226M008#0700	B	22	8	85	4	125	3.5	10	700	1	0.382	0.344	0.153
NOSB226M008#1800	B	22	8	85	4	125	3.5	10	1800	1	0.238	0.214	0.095
NOSC226M008#0500	C	22	8	85	4	125	3.5	10	500	1	0.514	0.462	0.206
NOSC336M008#0500	C	33	8	85	4	125	5.3	10	500	1	0.514	0.462	0.206
NOSC476M008#0400	C	47	8	85	4	125	7.5	10	400	1	0.574	0.517	0.230
NOSC686M008#0500	C	68	8	85	4	125	11.0	16	500	1	0.514	0.462	0.206
NOSD107M008#0400	D	100	8	85	4	125	16.0	16	400	3	0.671	0.604	0.268

Moisture Sensitivity Level (MSL) is defined according to J-STD-020.

All technical data relates to an ambient temperature of +25°C. Capacitance and DF are measured at 120Hz, 0.5V RMS with a maximum DC bias of 2.2 volts. DCL is measured at rated voltage after 5 minutes.

The EIA & CECC standards for capacitors allow an ESR movement to 1.25 times catalog limit post mounting.

NOTE: AVX reserves the right to supply a higher voltage rating or tighter tolerance part in the same case size, to the same reliability standards.

OxiCap[®] NOS Low ESR Series



Niobium Oxide Capacitor

QUALIFICATION TABLE

TEST	NOS series (Temperature range -55°C to +125°C)									
	Condition			Characteristics						
Endurance	Determine after application of rated voltage for 2000 +48/-0 hours at 85±2°C and then leaving 1-2 hours at room temperature. Also determine of 125°C temperature, category voltage for 2000 +48/-0 hours and then leaving 1-2 hours at room temperature. Power supply impedance to be ≤0.1Ω/V.			Visual examination	no visible damage					
				DCL	initial limit					
				ΔC/C	within ±10% of initial value					
				DF	initial limit					
				ESR	1.25 x initial limit					
Storage Life	125°C, 0V, 2000h			Visual examination	no visible damage					
				DCL	initial limit					
				ΔC/C	within ±10% of initial value					
				DF	initial limit					
				ESR	1.25 x initial limit					
Biased Humidity	Determine after leaving for 1000 hours at 85±2°C, 85% relative humidity and rated voltage and then recovery 1-2 hours at room temperature.			Visual examination	no visible damage					
				DCL	2 x initial limit					
				ΔC/C	within ±10% of initial value					
				DF	1.2 x initial limit					
				ESR	1.25 x initial limit					
Temperature Stability	Step	Temperature°C	Duration(min)		+20°C	-55°C	+20°C	+85°C	+125°C	+20°C
	1	+20±2	15	DCL	IL*	n/a	IL*	12 x IL*	15 x IL*	IL*
	2	-55+0/-3	15	ΔC/C	n/a	+0/-10%	±5%	+10/-0%	+12/-0%	±5%
	3	+20±2	15	DF	IL*	1.5 x IL*	IL*	1.5 x IL*	2 x IL*	IL*
	4	+85+3/-0	15	ESR	1.25 x IL*	2.5 x IL*	1.25 x IL*	1.25 x IL*	1.25 x IL*	1.25 x IL*
	5	+125+3/-0	15							
	6	+20±2	15							
Surge Voltage	Test temperature: 125°C+3/0°C Test voltage: Category voltage at 125°C Surge voltage: 1.3 x category voltage at 125°C Series protection resistance 1000±100Ω Discharge resistance: 1000Ω Number of cycles: 1000x Cycle duration: 6 min; 30 sec charge, 5 min 30 sec discharge			Visual examination	no visible damage					
				DCL	initial limit					
				ΔC/C	within ±5% of initial value					
				DF	initial limit					
				ESR	1.25 x initial limit					
Mechanical Shock	MIL-STD-202, Method 213, Condition F			Visual examination	no visible damage					
				DCL	initial limit					
				ΔC/C	within ±5% of initial value					
				DF	initial limit					
				ESR	1.25 x initial limit					
Vibration	MIL-STD-202, Method 204, Condition D			Visual examination	no visible damage					
				DCL	initial limit					
				ΔC/C	within ±5% of initial value					
				DF	initial limit					
				ESR	1.25 x initial limit					

*Initial Limit

OxiCap[®] NOM Low ESR Multianodes



Niobium Oxide Capacitor



FEATURES

- Multi-anode construction
- Super low ESR
- Non-burn safe technology
- CV range: 220-680µF / 1.8-6.3V
- IBM global approval received in 2004
- Elektra award received in 2005

APPLICATIONS

- High power low voltage industrial power supplies



LEAD-FREE
LEAD-FREE COMPATIBLE
COMPONENT



RoHS
COMPLIANT



NON-BURN
NON-SMOKE



Elektra Award
2005

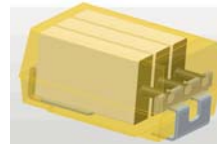
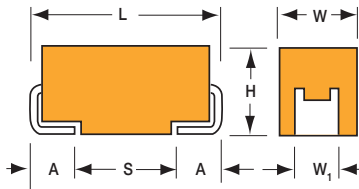

NOM MULTIANODE
CONSTRUCTION

MARKING

E CASE

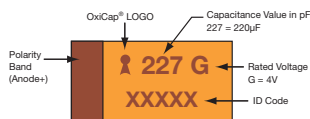

CASE DIMENSIONS: millimeters (inches)

Code	EIA Code	EIA Metric	L±0.20 (0.008)	W+0.20 (0.008) -0.10 (0.004)	H+0.20 (0.008) -0.10 (0.004)	W ₁ ±0.20 (0.008)	A+0.30 (0.012) -0.20 (0.008)	S Min.
E	2917	7343-43	7.30 (0.287)	4.30 (0.169)	4.10 (0.162)	2.40 (0.094)	1.30 (0.051)	4.40 (0.173)

W₁ dimension applies to the termination width for A dimensional area only.

HOW TO ORDER

NOM

Type

E

Case Size
See table above

227

Capacitance Code
1st two digits represent significant figures, 3rd digit represents multiplier in pF

M

Tolerance
M=±20%

006

Rated DC Voltage
001 = 1.8Vdc
002 = 2.5Vdc
004 = 4Vdc
006 = 6.3Vdc

R

Packaging
R = Pure Tin 7" Reel
S = Pure Tin 13" Reel

0040

ESR in mΩ

TECHNICAL SPECIFICATIONS

Technical Data:	All technical data relate to an ambient temperature of +25°C is not stated				
Capacitance Range:	220 µF to 680 µF				
Capacitance Tolerance:	±20%				
Leakage Current DCL:	0.02CV				
Rated Voltage DC (V _R)	≤ +85°C:	1.8	2.5	4	6.3
Category Voltage (V _C)	≤ +125°C:	0.9	1.3	2	3
Surge Voltage (V _S)	≤ +85°C:	2.3	3.3	5.2	8
Surge Voltage (V _S)	≤ +125°C:	1.2	1.7	2.6	4
Temperature Range:	-55°C to +125°C				
Reliability:	0.2% per 1000 hours at 85°C, V _R , 0.1Ω/V series impedance, 60% confidence level Meets requirements of AEC-Q200				

Niobium Oxide Capacitor

CAPACITANCE AND RATED VOLTAGE RANGE (LETTER DENOTES CASE SIZE)

Capacitance		Rated Voltage DC (V _R) to 85°C			
µF	Code	1.8V (x)	2.5V (e)	4.0V (G)	6.3V (J)
220	227				E(40)
330	337			E(35)	E(23,35)
470	477		E(30)	E(23,30)	
680	687	E(23)	E(23)		

Released ratings, (ESR ratings in mOhms in parenthesis)

Engineering samples - please contact AVX

*Ratings under development - subject to change

Note: Voltage ratings are minimum values. AVX reserves the right to supply higher ratings in the same case size, to the same reliability standards.

RATINGS & PART NUMBER REFERENCE

AVX Part No.	Case Size	Capacitance (µF)	Rated Voltage (V)	Rated Temperature (°C)	Category Voltage (V)	Category Temperature (°C)	DCL Max. (µA)	DF Max. (%)	ESR Max. @ 100kHz (mΩ)	MSL	100kHz RMS Current (A)		
											25°C	85°C	125°C
1.8 Volt @ 85°C													
NOME687M001#0023	E	680	1.8	85	0.9	125	24.5	6	23	3	3.753	3.378	1.501
2.5 Volt @ 85°C													
NOME477M002#0030	E	470	2.5	85	1.3	125	23.5	10	30	3	3.286	2.958	1.315
NOME687M002#0023	E	680	2.5	85	1.3	125	34	6	23	3	3.753	3.378	1.501
4 Volt @ 85°C													
NOME337M004#0035	E	330	4	85	2	125	26.4	8	35	3	3.043	2.738	1.217
NOME477M004#0023	E	470	4	85	2	125	37.6	6	23	3	3.753	3.378	1.501
NOME477M004#0030	E	470	4	85	2	125	37.6	6	30	3	3.286	2.958	1.315
6.3 Volt @ 85°C													
NOME227M006#0040	E	220	6.3	85	3	125	26.4	12	40	3	2.846	2.561	1.138
NOME337M006#0023	E	330	6.3	85	3	125	39.6	6	23	3	3.753	3.378	1.501
NOME337M006#0035	E	330	6.3	85	3	125	39.6	6	35	3	3.043	2.738	1.217

Moisture Sensitivity Level (MSL) is defined according to J-STD-020.

All technical data relates to an ambient temperature of +25°C. Capacitance and DF are measured at 120Hz, 0.5V RMS with a maximum DC bias of 2.2 volts.

DCL is measured at rated voltage after 5 minutes.

ESR allowed to move up to 125 times catalog limit post mounting.

For typical weight and composition see page 222.

NOTE: AVX reserves the right to supply a higher voltage rating or tighter tolerance part in the same case size, to the same reliability standards.

Niobium Oxide Capacitor

QUALIFICATION TABLE

TEST	NOM series (Temperature range -55°C to +125°C)										
	Condition			Characteristics							
Endurance	Determine after application of rated voltage for 2000 +48/-0 hours at 85±2°C and then leaving 1-2 hours at room temperature. Also determine of 125°C temperature, category voltage for 2000 +48/-0 hours and then leaving 1-2 hours at room temperature. Power supply impedance to be ≤0.1Ω/V.			Visual examination	no visible damage						
				DCL	initial limit						
				ΔC/C	within ±10% of initial value						
				DF	initial limit						
				ESR	1.25 x initial limit						
Storage Life	125°C, 0V, 2000h			Visual examination	no visible damage						
				DCL	initial limit						
				ΔC/C	within ±10% of initial value						
				DF	initial limit						
				ESR	1.25 x initial limit						
Humidity	Determine after storage without applied voltage at 65±2°C and 95±2% relative humidity for 500 hours and then recovery 1-2 hours at room temperature.			Visual examination	no visible damage						
				DCL	1.5 x initial limit						
				ΔC/C	within ±10% of initial value						
				DF	1.2 x initial limit						
				ESR	1.25 x initial limit						
Biased Humidity	Determine after leaving for 1000 hours at 85±2°C, 85% relative humidity and rated voltage and then recovery 1-2 hours at room temperature.			Visual examination	no visible damage						
				DCL	2 x initial limit						
				ΔC/C	within ±10% of initial value						
				DF	1.2 x initial limit						
				ESR	1.25 x initial limit						
Temperature Stability	Step	Temperature°C	Duration(min)		+20°C	-55°C	+20°C	+85°C	+125°C	+20°C	
	1	+20±2	15	DCL	IL*	n/a	IL*	12 x IL*	15 x IL*	IL*	
	2	-55+0/-3	15	ΔC/C	n/a	+0/-10%	±5%	+10/-0%	+12/-0%	±5%	
	3	+20±2	15	DF	IL*	1.5 x IL*	IL*	1.5 x IL*	2 x IL*	IL*	
	4	+85+3/-0	15	ESR	1.25 x IL*	2.5 x IL*	1.25 x IL*	1.25 x IL*	1.25 x IL*	1.25 x IL*	
	5	+125+3/-0	15								
	6	+20±2	15								
Surge Voltage	Test temperature: 125°C+3/0°C Test voltage: Category voltage at 125°C Surge voltage: 1.3 x category at 125°C Series protection resistance 1000±100Ω Discharge resistance: 1000Ω Number of cycles: 1000x Cycle duration: 6 min; 30 sec charge, 5 min 30 sec discharge			Visual examination	no visible damage						
				DCL	initial limit						
				ΔC/C	within ±5% of initial value						
				DF	initial limit						
				ESR	1.25 x initial limit						
Mechanical Shock	MIL-STD-202, Method 213, Condition F			Visual examination	no visible damage						
				DCL	initial limit						
				ΔC/C	within ±5% of initial value						
				DF	initial limit						
				ESR	1.25 x initial limit						
Vibration	MIL-STD-202, Method 204, Condition D			Visual examination	no visible damage						
				DCL	initial limit						
				ΔC/C	within ±5% of initial value						
				DF	initial limit						
				ESR	1.25 x initial limit						

*Initial Limit

Conductive Polymer Solid Electrolytic Chip Capacitors

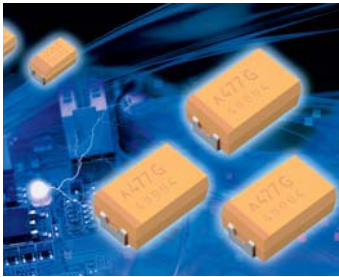

FEATURES

- Conductive polymer electrode
- Benign failure mode under recommended use conditions
- Lower ESR
- 3x reflow 260°C compatible
- CV range: 0.47-470µF / 2.5-125V
- 18 case sizes available

APPLICATIONS

- Smart phone, Tablets, Notebook, LCD TV, Power supplies



Elektra Award 2010



LEAD-FREE
LEAD-FREE COMPATIBLE
COMPONENT



RoHS
COMPLIANT

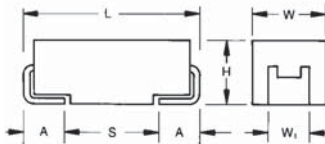

MARKING

A, B, C, D, E, G, H, K,
S, T, V, W, X, Y, 5 CASE

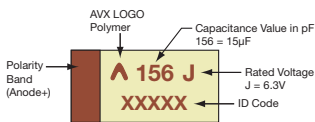

N, P, R CASE

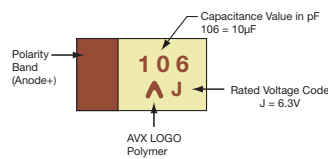

CASE DIMENSIONS: millimeters (inches)

Code	EIA Code	EIA Metric	L±0.20 (0.008)	W+0.20 (0.008) -0.10 (0.004)	H+0.20 (0.008) -0.10 (0.004)	W1±0.20 (0.008)	A+0.30 (0.012) -0.20 (0.008)	S Min.
A	1206	3216-18	3.20 (0.126)	1.60 (0.063)	1.60 (0.063)	1.20 (0.047)	0.80 (0.031)	1.10 (0.043)
B	1210	3528-21	3.50 (0.138)	2.80 (0.110)	1.90 (0.075)	2.20 (0.087)	0.80 (0.031)	1.40 (0.055)
C	2312	6032-28	6.00 (0.236)	3.20 (0.126)	2.60 (0.102)	2.20 (0.087)	1.30 (0.051)	2.90 (0.114)
D	2917	7343-31	7.30 (0.287)	4.30 (0.169)	2.90 (0.114)	2.40 (0.094)	1.30 (0.051)	4.40 (0.173)
E	2917	7343-43	7.30 (0.287)	4.30 (0.169)	4.10 (0.162)	2.40 (0.094)	1.30 (0.051)	4.40 (0.173)
G	1206	3216-15	3.20 (0.126)	1.60 (0.063)	1.50 (0.059) max	1.20 (0.047)	0.80 (0.031)	1.10 (0.043)
H	1210	3528-15	3.50 (0.138)	2.80 (0.110)	1.50 (0.059) max	2.20 (0.087)	0.80 (0.031)	1.40 (0.055)
K	1206	3216-10	3.20 (0.126)	1.60 (0.063)	1.00 (0.039) max	1.20 (0.047)	0.80 (0.031)	1.10 (0.043)
N	0805	2012-10	2.05 (0.081)	1.30 (0.051)	1.00 (0.039) max	1.00 (0.039)	0.50 (0.020)	0.85 (0.033)
P	0805	2012-15	2.05 (0.081)	1.35 (0.050)	1.50 (0.059) max	1.00±0.10 (0.039±0.004)	0.50 (0.020)	0.85 (0.033)
R	0805	2012-12	2.05 (0.081)	1.30 (0.051)	1.20 (0.047) max	1.00±0.10 (0.039±0.004)	0.50 (0.020)	0.85 (0.033)
S	1206	3216-12	3.20 (0.126)	1.60 (0.063)	1.20 (0.047) max	1.20 (0.047)	0.80 (0.031)	1.10 (0.043)
T	1210	3528-12	3.50 (0.138)	2.80 (0.110)	1.20 (0.047) max	2.20 (0.087)	0.80 (0.031)	1.40 (0.055)
V	2924	7361-38	7.30 (0.287)	6.10 (0.240)	3.55 (0.140)	3.10 (0.120)	1.30 (0.051)	4.40 (0.173)
W	2312	6032-15	6.00 (0.236)	3.20 (0.126)	1.50 (0.059) max	2.20 (0.087)	1.30 (0.051)	2.90 (0.114)
X	2917	7343-15	7.30 (0.287)	4.30 (0.169)	1.50 (0.059) max	2.40 (0.094)	1.30 (0.051)	4.40 (0.173)
Y	2917	7343-20	7.30 (0.287)	4.30 (0.169)	2.00 (0.079) max	2.40 (0.094)	1.30 (0.051)	4.40 (0.173)
5	2917	7343-40	7.30 (0.287)	4.30 (0.169)	3.80 (0.150)	2.40 (0.094)	1.30 (0.051)	4.40 (0.173)

W1 dimension applies to the termination width for A dimensional area only.

HOW TO ORDER

TCJ	A	226	M	004	R	0300
Type	Case Size	Capacitance Code	Tolerance	Rated DC Voltage	Packaging	ESR in mΩ
	See table above	pF code: 1st two digits represent significant figures, 3rd digit represents multiplier (number of zeros to follow)	M = ±20%	002 = 2.5Vdc 004 = 4Vdc 006 = 6.3Vdc 010 = 10Vdc 016 = 16Vdc 020 = 20Vdc 025 = 25Vdc	R = Pure Tin 7" Reel S = Pure Tin 13" Reel	
				035 = 35Vdc 050 = 50Vdc 063 = 63Vdc 075 = 75Vdc 100 = 100Vdc 125 = 125Vdc		

TECHNICAL SPECIFICATIONS (Common for all TCJ series)

Technical Data:	All technical data relate to an ambient temperature of +25°C
Capacitance Tolerance:	±20%
Leakage Current DCL:	0.1CV
Reliability:	1% per 1000 hours at 85°C, V _R with 0.1Ω/V series impedance, 60% confidence level
Resistance to soldering heat:	3x260°C peak for max. 10s reflow

NOTE: Conductive Polymer Capacitors are designed to operate within the limits of the environmental conditions specified for each series. If operated continuously at their maximum temperature and / or humidity limit, or beyond these limits, capacitors may exhibit a parametric shift in capacitance and increases in ESR. These changes may occur earlier if the specified environmental conditions are exceeded. Similarly, their normal operational time period will be significantly extended if their general duty cycle includes operation below maximum temperature within humidity controlled environments. Careful attention should be paid to maximum temperature with associated high humidity environments as well as voltage derating, ripple current and current surges. Please reference the AVX Conductive Polymer Capacitor Guidelines for more information or contact factory for application assistance.

CAPACITANCE AND RATED VOLTAGE RANGE (LETTER DENOTES CASE SIZE)

Cap		Rated Voltage DC (V _R) to 85°C												
µF	Code	2.5V (e)	4V (G)	6.3V (J)	10V (A)	16V (C)	20V (D)	25V (E)	35V (V)	50V (T)	63V (J)	75V (P)	100V (A)	125V (B)
0.47	474										B(400)			
0.68	684									B(400)	B(300)			
1.0	105							P(500)		B(300)	B(300) C(300)			
1.5	155								B(200)	B(300) C(300)	C(300)			
2.2	225								B(200)	C(300)	C(200)			
3.3	335								B(200)	C(200)	C(200)			D(250)
4.7	475				K(300,500) R(500)			B(100,150)	B(200) C(200)	C(200) X(250) Y(250)	C(200) D(120)	D(150)	D(250)	
6.8	685					A(200)		A(150), B(90,150) T(100,150)	C(200)	C(200) D(120)	D(120) E(100,150)	D(120)		
10	106			A(300) N(200,250,500) R(500)	A(200,300)	A(200) B(100,200) T(100,150,200)	A(150)	A(150) B(90,100,150)	B(200) C(200) Y(70)	D(120) E(70,100)	E(100,150)	U*	U*	
15	156		A(300)	A(300)	A(200)	B(150)		B(100,150) Y(90)	B(200), C(200) D(70,100) Y(70,100)	E(70,100)				
22	226		A(300)	A(300), K(400) N(500), R(500) S(400), T(150)	B(300) T(70,150)	B(150)	B(90,150) Y(70)	B(100,150), C(100) D(60,100) Y(70)	D(70,100) Y(150)					
33	336		A(300)	A(200) B(70,200) T(150)	B(70,200) C(100) T(70,150)	Y(45,60,70)	Y(70)	D(60,100) X(70,100) Y(60,70,100)	D(70,100) E(55,70)					
47	476		A(200) T(80)	A(70,100,200), B(70) K(150,200,400) P(500), R(500) T(55,69,70,80,120)	B(70) C(100)	X(45,70) Y(45,70)	D(55) X(55,70) Y(70)	D(60,100) E(50)	E(55)					
68	686	A(250)	A(250) B(70) T(80)	B(55,70) C(100) T(200), W(70)	D(45,55) Y(45,55)	D(50) Y(50)	D(55) E(45)	D(70) E(50)						
100	107	A(200), B(70)	A(200) B(40,70) G(300) T(70,150)	A(100,150) B(40,45,55,69,70) T(70,200)	D(45,55,80) Y(25,45,55)	D(50), E(40) Y(50)	D(55) E(45)	D(55,70) E(80)						
150	157	B(70)	B(70), D(15) Y(15,25,45)	B(25,35,45,55,69,70) D(12,15,25,40) H(200), W(40,70) Y(15,25,40)	D(25,40,45,55) Y(25,40,45,55)	D(40,50,70) E(40) Y(40,50,70)								
220	227	B(35,45,70)	B(35,45,55,60,70) D(12,15,25,40) Y(15,25,40)	B(70,200) D(12,15,25,35,40,50) H(170) Y(15,25,35,40,50)	D(12,15,25,40,50) Y(15,25,40,50)									
330	337	B(35,45,70) Y(25,40)	D(15,25,40,50) Y(15,25,40,50)	D(12,15,25,40,50) Y(15,25,40,50)	5(35,100)	E(50,70) 5(100)								
470	477	D(12,15,25,40,50) Y(15,25,40,50)	D(10,12,15,25,40,50) Y(15,25,40,50)	X(50,55,100)		5(100)								
3300	338			U*										

Released ratings, (ESR ratings in mOhms in parenthesis)

Engineering samples - please contact AVX

*Ratings under development – subject to change

Note: Voltage ratings are minimum values. AVX reserves the right to supply higher ratings in the same case size, to the same reliability standards.

TCJ Series



Conductive Polymer Solid Electrolytic Chip Capacitors

RATINGS & PART NUMBER REFERENCE

AVX Part No.	Case Size	Capacitance (µF)	Rated Voltage (V)	Maximum Operating Temperature (°C)	DCL Max. (µA)	DF Max. (%)	ESR Max. @ 100kHz (mΩ)	MSL	100kHz RMS Current (mA)				Product Category
									45°C	85°C	105°C	125°C	
2.5 Volt @ 85°C													
TCJA686M002#0250	A	68	2.5	105	17	6	250	3	600	400	300	-	3
TCJA107M002#0200	A	100	2.5	105	25	6	200	3	700	500	300	-	3
TCJB107M002#0070	B	100	2.5	125	25	6	70	3	1300	900	600	300	1
TCJB157M002#0070	B	150	2.5	105	37.5	6	70	3	1300	900	600	-	3
TCJB227M002#0035	B	220	2.5	105	55	8	35	3	1900	1300	900	-	3
TCJB227M002#0045	B	220	2.5	105	55	8	45	3	1700	1200	800	-	3
TCJB227M002#0070	B	220	2.5	105	55	8	70	3	1300	900	600	-	3
TCJB337M002#0035	B	330	2.5	105	82.5	8	35	3	1900	1300	900	-	3
TCJB337M002#0045	B	330	2.5	105	82.5	8	45	3	1700	1200	800	-	3
TCJB337M002#0070	B	330	2.5	105	82.5	8	70	3	1300	900	600	-	3
TCJY337M002#0025	Y	330	2.5	105	82.5	6	25	3	2700	1900	1200	-	2
TCJY337M002#0040	Y	330	2.5	105	82.5	6	40	3	2200	1500	1000	-	3
TCJD477M002#0012	D	470	2.5	105	117.5	6	12	3	4300	3000	1900	-	2
TCJD477M002#0015	D	470	2.5	105	117.5	6	15	3	3900	2700	1800	-	2
TCJD477M002#0025	D	470	2.5	105	117.5	6	25	3	3000	2100	1400	-	2
TCJD477M002#0040	D	470	2.5	105	117.5	6	40	3	2400	1700	1100	-	3
TCJD477M002#0050	D	470	2.5	105	117.5	6	50	3	2100	1500	900	-	3
TCJY477M002#0015	Y	470	2.5	85	117.5	6	15	3	3500	2500	-	-	5
TCJY477M002#0025	Y	470	2.5	105	117.5	6	25	3	2700	1900	1200	-	3
TCJY477M002#0040	Y	470	2.5	105	117.5	6	40	3	2200	1500	1000	-	3
TCJY477M002#0050	Y	470	2.5	105	117.5	6	50	3	1900	1300	900	-	3
4 Volt @ 85°C													
TCJA156M004#0300	A	15	4	125	6	6	300	3	600	400	300	200	1
TCJA226M004#0300	A	22	4	125	8.8	6	300	3	600	400	300	200	1
TCJA336M004#0300	A	33	4	125	13.2	6	300	3	600	400	300	200	1
TCJA476M004#0200	A	47	4	105	18.8	6	200	3	700	500	300	-	3
TCJT476M004#0080	T	47	4	105	18.8	8	80	3	1100	800	500	-	3
TCJA686M004#0250	A	68	4	105	27.2	6	250	3	600	400	300	-	3
TCJB686M004#0070	B	68	4	125	27.2	6	70	3	1300	900	600	300	1
TCJT686M004#0080	T	68	4	105	27.2	8	80	3	1100	800	500	-	3
TCJA107M004#0200	A	100	4	105	40	6	200	3	700	500	300	-	3
TCJB107M004#0040	B	100	4	105	40	8	40	3	1800	1300	800	-	3
TCJB107M004#0070	B	100	4	125	40	8	70	3	1300	900	600	300	1
TCJG107M004#0300	G	100	4	105	40	10	300	3	600	400	300	-	3
TCJT107M004#0070	T	100	4	105	40	8	70	3	1200	800	500	-	3
TCJT107M004#0150	T	100	4	105	40	8	150	3	800	600	400	-	3
TCJB157M004#0070	B	150	4	105	60	6	70	3	1300	900	600	-	3
TCJD157M004#0015	D	150	4	105	60	6	15	3	3900	2700	1800	-	2
TCJY157M004#0015	Y	150	4	105	60	6	15	3	3500	2500	1600	-	2
TCJY157M004#0025	Y	150	4	105	60	6	25	3	2700	1900	1200	-	2
TCJY157M004#0045	Y	150	4	105	60	6	45	3	2000	1400	900	-	3
TCJB227M004#0035	B	220	4	105	88	10	35	3	1900	1300	900	-	3
TCJB227M004#0045	B	220	4	105	88	10	45	3	1700	1200	800	-	3
TCJB227M004#0055	B	220	4	105	88	10	55	3	1500	1100	700	-	3
TCJB227M004#0060	B	220	4	105	88	10	60	3	1400	1000	600	-	3
TCJB227M004#0070	B	220	4	105	88	10	70	3	1300	900	600	-	3
TCJD227M004#0012	D	220	4	105	88	6	12	3	4300	3000	1900	-	2
TCJD227M004#0015	D	220	4	105	88	6	15	3	3900	2700	1800	-	2
TCJD227M004#0025	D	220	4	105	88	6	25	3	3000	2100	1400	-	2
TCJD227M004#0040	D	220	4	105	88	6	40	3	2400	1700	1100	-	2
TCJY227M004#0015	Y	220	4	105	88	6	15	3	3500	2500	1600	-	2
TCJY227M004#0025	Y	220	4	105	88	6	25	3	2700	1900	1200	-	2
TCJY227M004#0040	Y	220	4	105	88	6	40	3	2200	1500	1000	-	3
TCJD337M004#0015	D	330	4	105	132	6	15	3	3900	2700	1800	-	2
TCJD337M004#0025	D	330	4	105	132	6	25	3	3000	2100	1400	-	2
TCJD337M004#0040	D	330	4	105	132	6	40	3	2400	1700	1100	-	3
TCJD337M004#0050	D	330	4	105	132	6	50	3	2100	1500	900	-	3
TCJY337M004#0015	Y	330	4	85	132	6	15	3	3500	2500	-	-	5
TCJY337M004#0025	Y	330	4	105	132	6	25	3	2700	1900	1200	-	3
TCJY337M004#0040	Y	330	4	105	132	6	40	3	2200	1500	1000	-	3
TCJY337M004#0050	Y	330	4	105	132	6	50	3	1900	1300	900	-	3
TCJD477M004#0010	D	470	4	105	188	6	10	3	4700	3300	2100	-	2
TCJD477M004#0012	D	470	4	105	188	6	12	3	4300	3000	1900	-	2
TCJD477M004#0015	D	470	4	105	188	6	15	3	3900	2700	1800	-	2
TCJD477M004#0025	D	470	4	105	188	6	25	3	3000	2100	1400	-	2
TCJD477M004#0040	D	470	4	105	188	6	40	3	2400	1700	1100	-	2
TCJD477M004#0050	D	470	4	105	188	6	50	3	2100	1500	900	-	2
TCJY477M004#0015	Y	470	4	85	188	6	15	3	3500	2500	-	-	5
TCJY477M004#0025	Y	470	4	105	188	6	25	3	2700	1900	1200	-	3
TCJY477M004#0040	Y	470	4	105	188	6	40	3	2200	1500	1000	-	3
TCJY477M004#0050	Y	470	4	105	188	6	50	3	1900	1300	900	-	3
6.3 Volt @ 85°C													
TCJA106M006#0300	A	10	6.3	125	6	6	300	3	600	400	300	200	1
TCJN106M006#0200	N	10	6.3	105	6	6	200	3	600	400	300	-	3
TCJN106M006#0250	N	10	6.3	105	6	6	250	3	600	400	300	-	3
TCJN106M006#0500	N	10	6.3	105	6	6	500	3	400	300	200	-	3
TCJR106M006#0500	R	10	6.3	105	6	6	500	3	400	300	200	-	3



RATINGS & PART NUMBER REFERENCE

AVX Part No.	Case Size	Capacitance (µF)	Rated Voltage (V)	Maximum Operating Temperature (°C)	DCL Max. (µA)	DF Max. (%)	ESR Max. @ 100kHz (mΩ)	MSL	100kHz RMS Current (mA)				Product Category
									45°C	85°C	105°C	125°C	
TCJA156M006#0300	A	15	6.3	125	9	6	300	3	600	400	300	200	1
TCJA226M006#0300	A	22	6.3	125	13.2	6	300	3	600	400	300	200	1
TCJK226M006#0400	K	22	6.3	105	13.2	8	400	3	500	400	200	-	3
TCJN226M006#0500	N	22	6.3	105	13.2	10	500	3	400	300	200	-	3
TCJR226M006#0500	R	22	6.3	105	13.2	10	500	3	400	300	200	-	3
TCJS226M006#0400	S	22	6.3	105	13.2	8	400	3	500	400	200	-	3
TCJT226M006#0150	T	22	6.3	105	13.2	6	150	3	800	600	400	-	3
TCJA336M006#0200	A	33	6.3	105	19.8	6	200	3	700	500	300	-	3
TCJB336M006#0070	B	33	6.3	125	19.8	6	70	3	1300	900	600	300	1
TCJB336M006#0200	B	33	6.3	125	19.8	6	200	3	800	600	400	200	1
TCJT336M006#0150	T	33	6.3	105	19.8	8	150	3	800	600	400	-	3
TCJA476M006#0070	A	47	6.3	105	28.2	6	70	3	1200	800	500	-	3
TCJA476M006#0100	A	47	6.3	105	28.2	6	100	3	1000	700	500	-	3
TCJA476M006#0200	A	47	6.3	105	28.2	6	200	3	700	500	300	-	3
TCJB476M006#0070	B	47	6.3	125	28.2	6	70	3	1300	900	600	300	1
TCJA476M006#0150	K	47	6.3	105	28.2	6	150	3	800	600	400	-	3
TCJK476M006#0200	K	47	6.3	105	28.2	6	200	3	700	500	300	-	3
TCJK476M006#0400	K	47	6.3	105	28.2	6	400	3	500	400	200	-	3
TCJP476M006#0500	P	47	6.3	105	28.2	10	500	3	400	300	200	-	3
TCJR476M006#0500	R	47	6.3	105	28.2	10	500	3	400	300	200	-	3
TCJT476M006#0055	T	47	6.3	105	28.2	8	55	3	1300	900	600	-	3
TCJT476M006#0069	T	47	6.3	105	20	8	69	3	1200	800	500	-	3
TCJT476M006#0070	T	47	6.3	105	28.2	8	70	3	1200	800	500	-	3
TCJT476M006#0080	T	47	6.3	105	28.2	8	80	3	1100	800	500	-	3
TCJT476M006#0120	T	47	6.3	105	28.2	8	120	3	900	600	400	-	3
TCJB686M006#0055	B	68	6.3	125	40.8	8	55	3	1500	1100	700	400	1
TCJB686M006#0070	B	68	6.3	125	40.8	8	70	3	1300	900	600	300	1
TCJC686M006#0100	C	68	6.3	125	40.8	6	100	3	1300	900	600	300	1
TCJT686M006#0200	T	68	6.3	105	40.8	8	200	3	700	500	300	-	3
TCJW686M006#0070	W	68	6.3	125	40.8	8	70	3	1400	1000	600	400	1
TCJA107M006#0100	A	100	6.3	105	60	10	100	3	1000	700	500	-	3
TCJA107M006#0150	A	100	6.3	105	60	10	150	3	800	600	400	-	3
TCJB107M006#0040	B	100	6.3	105	60	10	40	3	1800	1300	800	-	3
TCJB107M006#0045	B	100	6.3	105	60	10	45	3	1700	1200	800	-	3
TCJB107M006#0055	B	100	6.3	105	60	10	55	3	1500	1100	700	-	3
TCJB107M006#0069	B	100	6.3	105	60	10	69	3	1300	900	600	-	3
TCJB107M006#0070	B	100	6.3	105	60	10	70	3	1300	900	600	-	3
TCJT107M006#0070	T	100	6.3	105	60	10	70	3	1200	800	500	-	3
TCJT107M006#0200	T	100	6.3	105	60	10	200	3	700	500	300	-	3
TCJB157M006#0025	B	150	6.3	105	90	10	25	3	2200	1500	1000	-	3
TCJB157M006#0035	B	150	6.3	105	90	10	35	3	1900	1300	900	-	3
TCJB157M006#0045	B	150	6.3	105	90	10	45	3	1700	1200	800	-	3
TCJB157M006#0055	B	150	6.3	105	90	10	55	3	1500	1100	700	-	3
TCJB157M006#0069	B	150	6.3	105	90	10	69	3	1300	900	600	-	3
TCJB157M006#0070	B	150	6.3	105	90	10	70	3	1300	900	600	-	3
TCJD157M006#0012	D	150	6.3	105	90	6	12	3	4300	3000	1900	-	2
TCJD157M006#0015	D	150	6.3	105	90	6	15	3	3900	2700	1800	-	2
TCJD157M006#0025	D	150	6.3	105	90	6	25	3	3000	2100	1400	-	2
TCJD157M006#0040	D	150	6.3	105	90	6	40	3	2400	1700	1100	-	2
TCJH157M006#0200	H	150	6.3	105	90	6	200	3	700	500	300	-	3
TCJW157M006#0040	W	150	6.3	105	90	6	40	3	1800	1300	800	-	3
TCJW157M006#0070	W	150	6.3	105	90	6	70	3	1400	1000	600	-	3
TCJY157M006#0015	Y	150	6.3	105	90	6	15	3	3500	2500	1600	-	2
TCJY157M006#0025	Y	150	6.3	105	90	6	25	3	2700	1900	1200	-	2
TCJY157M006#0040	Y	150	6.3	105	90	6	40	3	2200	1500	1000	-	3
TCJB227M006#0070	B	220	6.3	105	132	10	70	3	1300	900	600	-	3
TCJB227M006#0200	B	220	6.3	105	132	10	200	3	800	600	400	-	3
TCJD227M006#0012	D	220	6.3	105	132	6	12	3	4300	3000	1900	-	2
TCJD227M006#0015	D	220	6.3	105	132	6	15	3	3900	2700	1800	-	2
TCJD227M006#0025	D	220	6.3	105	132	6	25	3	3000	2100	1400	-	2
TCJD227M006#0035	D	220	6.3	105	132	6	35	3	2500	1800	1100	-	3
TCJD227M006#0040	D	220	6.3	105	132	6	40	3	2400	1700	1100	-	3
TCJD227M006#0050	D	220	6.3	105	132	6	50	3	2100	1500	900	-	3
TCJH227M006#0170	H	220	6.3	105	132	10	170	3	800	600	400	-	3
TCJY227M006#0015	Y	220	6.3	85	132	6	15	3	3500	2500	-	-	5
TCJY227M006#0025	Y	220	6.3	105	132	6	25	3	2700	1900	1200	-	2
TCJY227M006#0035	Y	220	6.3	105	132	6	35	3	2300	1600	1000	-	2
TCJY227M006#0040	Y	220	6.3	105	132	6	40	3	2200	1500	1000	-	2
TCJY227M006#0050	Y	220	6.3	105	132	6	50	3	1900	1300	900	-	2
TCJD337M006#0012	D	330	6.3	105	198	6	12	3	4300	3000	1900	-	3
TCJD337M006#0015	D	330	6.3	105	198	6	15	3	3900	2700	1800	-	3
TCJD337M006#0025	D	330	6.3	105	198	6	25	3	3000	2100	1400	-	3
TCJD337M006#0040	D	330	6.3	105	198	6	40	3	2400	1700	1100	-	2
TCJD337M006#0050	D	330	6.3	105	198	6	50	3	2100	1500	900	-	2
TCJY337M006#0015	Y	330	6.3	85	198	12	15	3	3500	2500	-	-	5
TCJY337M006#0025	Y	330	6.3	105	198	12	25	3	2700	1900	1200	-	3
TCJY337M006#0040	Y	330	6.3	105	198	12	40	3	2200	1500	1000	-	3
TCJY337M006#0050	Y	330	6.3	105	198	12	50	3	1900	1300	900	-	3
TCJX477M006#0050	X	470	6.3	105	282	6	50	3	1900	1300	900	-	3

TCJ Series



Conductive Polymer Solid Electrolytic Chip Capacitors

RATINGS & PART NUMBER REFERENCE

AVX Part No.	Case Size	Capacitance (µF)	Rated Voltage (V)	Maximum Operating Temperature (°C)	DCL Max. (µA)	DF Max. (%)	ESR Max. @ 100kHz (mΩ)	MSL	100kHz RMS Current (mA)				Product Category
									45°C	85°C	105°C	125°C	
TCJX477M006#0055	X	470	6.3	105	282	6	55	3	1800	1300	800	-	3
TCJX477M006#0100	X	470	6.3	105	282	6	100	3	1300	900	600	-	3
10 Volt @ 85°C													
TCJK475M010#0300	K	4.7	10	105	4.7	6	300	3	500	400	200	-	3
TCJK475M010#0500	K	4.7	10	105	4.7	6	500	3	400	300	200	-	3
TCJR475M010#0500	R	4.7	10	105	4.7	6	500	3	400	300	200	-	3
TCJA106M010#0200	A	10	10	125	10	6	200	3	700	500	300	200	1
TCJA106M010#0300	A	10	10	125	10	6	300	3	600	400	300	200	1
TCJA156M010#0200	A	15	10	125	15	6	200	3	700	500	300	200	1
TCJB226M010#0300	B	22	10	125	22	6	300	3	600	400	300	200	1
TCJT226M010#0070	T	22	10	105	22	6	70	3	1200	800	500	-	3
TCJT226M010#0150	T	22	10	105	22	6	150	3	800	600	400	-	3
TCJB336M010#0070	B	33	10	125	33	6	70	3	1300	900	600	300	1
TCJB336M010#0200	B	33	10	125	33	6	200	3	800	600	400	200	1
TCJC336M010#0100	C	33	10	125	33	6	100	3	1300	900	600	300	1
TCJT336M010#0070	T	33	10	105	33	6	70	3	1200	800	500	-	3
TCJT336M010#0150	T	33	10	105	33	6	150	3	800	600	400	-	3
TCJB476M010#0070	B	47	10	105	47	6	70	3	1300	900	600	-	3
TCJC476M010#0100	C	47	10	125	47	6	100	3	1300	900	600	300	1
TCJD686M010#0045	D	68	10	105	68	6	45	3	2200	1500	1000	-	3
TCJD686M010#0055	D	68	10	105	68	6	55	3	2000	1400	900	-	3
TCJY686M010#0045	Y	68	10	105	68	6	45	3	2000	1400	900	-	3
TCJY686M010#0055	Y	68	10	105	68	6	55	3	1800	1300	800	-	3
TCJD107M010#0045	D	100	10	105	100	6	45	3	2200	1500	1000	-	3
TCJD107M010#0055	D	100	10	105	100	6	55	3	2000	1400	900	-	3
TCJD107M010#0080	D	100	10	105	100	6	80	3	1700	1200	800	-	3
TCJY107M010#0025	Y	100	10	105	100	6	25	3	2700	1900	1200	-	2
TCJY107M010#0045	Y	100	10	105	100	6	45	3	2000	1400	900	-	3
TCJY107M010#0055	Y	100	10	105	100	6	55	3	1800	1300	800	-	3
TCJD157M010#0025	D	150	10	105	150	6	25	3	3000	2100	1400	-	3
TCJD157M010#0040	D	150	10	105	150	6	40	3	2400	1700	1100	-	3
TCJD157M010#0045	D	150	10	105	150	6	45	3	2200	1500	1000	-	3
TCJD157M010#0055	D	150	10	105	150	6	55	3	2000	1400	900	-	3
TCJY157M010#0025	Y	150	10	105	150	6	25	3	2700	1900	1200	-	3
TCJY157M010#0040	Y	150	10	105	150	6	40	3	2200	1500	1000	-	3
TCJY157M010#0045	Y	150	10	105	150	6	45	3	2000	1400	900	-	3
TCJY157M010#0055	Y	150	10	105	150	6	55	3	1800	1300	800	-	3
TCJD227M010#0012	D	220	10	105	220	6	12	3	4300	3000	1900	-	3
TCJD227M010#0015	D	220	10	105	220	6	15	3	3900	2700	1800	-	3
TCJD227M010#0025	D	220	10	105	220	6	25	3	3000	2100	1400	-	3
TCJD227M010#0040	D	220	10	105	220	6	40	3	2400	1700	1100	-	3
TCJD227M010#0050	D	220	10	105	220	6	50	3	2100	1500	900	-	3
TCJY227M010#0015	Y	220	10	85	220	6	15	3	3500	2500	-	-	5
TCJY227M010#0025	Y	220	10	105	220	6	25	3	2700	1900	1200	-	3
TCJY227M010#0040	Y	220	10	105	220	6	40	3	2200	1500	1000	-	3
TCJY227M010#0050	Y	220	10	105	220	6	50	3	1900	1300	900	-	3
TCJ5337M010#0035	5	330	10	105	330	10	35	3	1800	1300	800	-	2
TCJ5337M010#0100	5	330	10	105	330	10	100	3	1300	900	600	-	2
16 Volt @ 85°C													
TCJA685M016#0200	A	6.8	16	125	10.9	6	200	3	700	500	300	200	1
TCJA106M016#0200	A	10	16	125	16	6	200	3	700	500	300	200	1
TCJB106M016#0100	B	10	16	125	16	6	100	3	1100	800	500	300	1
TCJB106M016#0200	B	10	16	125	16	6	200	3	800	600	400	200	1
TCJT106M016#0100	T	10	16	125	16	6	100	3	1000	700	500	300	1
TCJT106M016#0150	T	10	16	125	16	6	150	3	800	600	400	200	1
TCJT106M016#0200	T	10	16	125	16	6	200	3	700	500	300	200	1
TCJB156M016#0150	B	15	16	125	24	6	150	3	900	600	400	200	1
TCJB226M016#0150	B	22	16	125	35.2	6	150	3	900	600	400	200	1
TCJY336M016#0045	Y	33	16	105	52.8	6	45	3	2000	1400	900	-	2
TCJY336M016#0060	Y	33	16	105	52.8	6	60	3	1800	1300	800	-	2
TCJY336M016#0070	Y	33	16	105	52.8	6	70	3	1600	1100	700	-	2
TCJX476M016#0045	X	47	16	105	75.2	6	45	3	2000	1400	900	-	2
TCJX476M016#0070	X	47	16	105	75.2	6	70	3	1600	1100	700	-	2
TCJY476M016#0045	Y	47	16	105	75.2	6	45	3	2000	1400	900	-	2
TCJY476M016#0070	Y	47	16	105	75.2	6	70	3	1600	1100	700	-	2
TCJD686M016#0050	D	68	16	105	108.8	6	50	3	2100	1500	900	-	2
TCJY686M016#0050	Y	68	16	105	108.8	6	50	3	1900	1300	900	-	2
TCJD107M016#0050	D	100	16	105	160	6	50	3	2100	1500	900	-	2
TCJE107M016#0040	E	100	16	105	160	6	40	3	2500	1800	1100	-	2
TCJY107M016#0050	Y	100	16	105	160	6	50	3	1900	1300	900	-	2
TCJD157M016#0040	D	150	16	85	240	6	40	3	2400	1700	-	-	5
TCJD157M016#0050	D	150	16	85	240	6	50	3	2100	1500	-	-	5
TCJD157M016#0070	D	150	16	105	240	6	70	3	1800	1300	800	-	3
TCJE157M016#0040	E	150	16	105	240	6	40	3	2500	1800	1100	-	2
TCJY157M016#0040	Y	150	16	85	240	6	40	3	2200	1500	-	-	5
TCJY157M016#0050	Y	150	16	85	240	6	50	3	1900	1300	-	-	5
TCJY157M016#0070	Y	150	16	105	240	6	70	3	1600	1100	700	-	3
TCJE337M016#0050	E	330	16	105	528	10	50	3	2200	1500	1000	-	2
TCJE337M016#0070	E	330	16	105	528	10	70	3	1900	1300	900	-	2

RATINGS & PART NUMBER REFERENCE

AVX Part No.	Case Size	Capacitance (µF)	Rated Voltage (V)	Maximum Operating Temperature (°C)	DCL Max. (µA)	DF Max. (%)	ESR Max. @ 100kHz (mΩ)	MSL	100kHz RMS Current (mA)				Product Category
									45°C	85°C	105°C	125°C	
TCJ5337M016#0100	5	330	16	105	528	10	100	3	1300	900	600	-	2
TCJ5477M016#0100	5	470	16	105	752	10	100	3	1300	900	600	-	3
20 Volt @ 85°C													
TCJA106M020#0150	A	10	20	105	20	6	150	3	800	600	400	-	3
TCJB226M020#0090	B	22	20	105	44	6	90	3	1200	800	500	-	3
TCJB226M020#0150	B	22	20	105	44	6	150	3	900	600	400	-	3
TCJY226M020#0070	Y	22	20	105	44	6	70	3	1600	1100	700	-	2
TCJY336M020#0070	Y	33	20	105	66	6	70	3	1600	1100	700	-	2
TCJD476M020#0055	D	47	20	105	94	6	55	3	2000	1400	900	-	2
TCJX476M020#0055	X	47	20	105	94	6	55	3	1800	1300	800	-	3
TCJX476M020#0070	X	47	20	105	94	6	70	3	1600	1100	700	-	3
TCJY476M020#0070	Y	47	20	105	94	6	70	3	1600	1100	700	-	2
TCJD686M020#0055	D	68	20	105	136	6	55	3	2000	1400	900	-	3
TCJE686M020#0045	E	68	20	105	136	6	45	3	2400	1700	1100	-	2
TCJD107M020#0055	D	100	20	105	200	6	55	3	2000	1400	900	-	3
TCJE107M020#0045	E	100	20	105	200	6	45	3	2400	1700	1100	-	3
25 Volt @ 85°C													
TCJP105M025#0500	P	1.0	25	105	2.5	6	500	3	400	300	200	-	2
TCJB475M025#0100	B	4.7	25	105	11.8	6	100	3	1100	800	500	-	3
TCJB475M025#0150	B	4.7	25	105	11.8	6	150	3	900	600	400	-	3
TCJA685M025#0150	A	6.8	25	105	17	6	150	3	800	600	400	-	3
TCJB685M025#0090	B	6.8	25	105	17	6	90	3	1200	800	500	-	2
TCJB685M025#0150	B	6.8	25	105	17	6	150	3	900	600	400	-	3
TCJT685M025#0100	T	6.8	25	105	17	6	100	3	1000	700	500	-	3
TCJT685M025#0150	T	6.8	25	105	17	6	150	3	800	600	400	-	3
TCJA106M025#0150	A	10	25	105	25	6	150	3	800	600	400	-	3
TCJB106M025#0090	B	10	25	105	25	6	90	3	1200	800	500	-	2
TCJB106M025#0100	B	10	25	105	25	6	100	3	1100	800	500	-	2
TCJB106M025#0150	B	10	25	105	25	6	150	3	900	600	400	-	2
TCJB156M025#0100	B	15	25	105	37.5	6	100	3	1100	800	500	-	2
TCJB156M025#0150	B	15	25	105	37.5	6	150	3	900	600	400	-	2
TCJY156M025#0090	Y	15	25	105	37.5	6	90	3	1400	1000	600	-	2
TCJB226M025#0100	B	22	25	105	55	6	100	3	1100	800	500	-	3
TCJB226M025#0150	B	22	25	105	55	6	150	3	900	600	400	-	3
TCJC226M025#0100	C	22	25	105	55	6	100	3	1300	900	600	-	3
TCJD226M025#0060	D	22	25	105	55	6	60	3	1900	1300	900	-	2
TCJD226M025#0100	D	22	25	105	55	6	100	3	1500	1100	700	-	2
TCJY226M025#0070	Y	22	25	105	55	6	70	3	1600	1100	700	-	3
TCJD336M025#0060	D	33	25	105	82.5	6	60	3	1900	1300	900	-	2
TCJD336M025#0100	D	33	25	105	82.5	6	100	3	1500	1100	700	-	2
TCJX336M025#0070	X	33	25	105	82.5	6	70	3	1600	1100	700	-	2
TCJX336M025#0100	X	33	25	105	82.5	6	100	3	1300	900	600	-	2
TCJY336M025#0060	Y	33	25	105	82.5	6	60	3	1800	1300	800	-	2
TCJY336M025#0070	Y	33	25	105	82.5	6	70	3	1600	1100	700	-	2
TCJY336M025#0100	Y	33	25	105	82.5	6	100	3	1400	1000	600	-	2
TCJD476M025#0060	D	47	25	105	117.5	6	60	3	1900	1300	900	-	3
TCJD476M025#0100	D	47	25	105	117.5	6	100	3	1500	1100	700	-	3
TCJE476M025#0050	E	47	25	105	117.5	6	50	3	2200	1500	1000	-	3
TCJD686M025#0070	D	68	25	105	170	6	70	3	1800	1300	800	-	2
TCJE686M025#0050	E	68	25	105	170	6	50	3	2200	1500	1000	-	3
TCJD107M025#0055	D	100	25	105	250	6	55	3	2000	1400	900	-	2
TCJD107M025#0070	D	100	25	105	250	6	70	3	1800	1300	800	-	2
TCJE107M025#0080	E	100	25	105	250	6	80	3	1800	1300	800	-	2
35 Volt @ 85°C													
TCJB155M035#0200	B	1.5	35	105	5.3	6	200	3	800	600	400	-	2
TCJB225M035#0200	B	2.2	35	105	7.7	6	200	3	800	600	400	-	3
TCJB335M035#0200	B	3.3	35	105	11.6	6	200	3	800	600	400	-	3
TCJB475M035#0200	B	4.7	35	105	16.5	6	200	3	800	600	400	-	3
TCJC475M035#0200	C	4.7	35	105	16.5	6	200	3	900	600	400	-	3
TCJC685M035#0200	C	6.8	35	105	23.8	6	200	3	900	600	400	-	3
TCJB106M035#0200	B	10	35	105	35	6	200	3	800	600	400	-	2
TCJC106M035#0200	C	10	35	105	35	6	200	3	900	600	400	-	3
TCJY106M035#0070	Y	10	35	105	35	6	70	3	1600	1100	700	-	2
TCJB156M035#0200	B	15	35	105	52.5	6	200	3	800	600	400	-	2
TCJC156M035#0200	C	15	35	105	52.5	6	200	3	900	600	400	-	3
TCJD156M035#0070	D	15	35	105	52.5	6	70	3	1800	1300	800	-	3
TCJD156M035#0100	D	15	35	105	52.5	6	100	3	1500	1100	700	-	3
TCJY156M035#0070	Y	15	35	105	52.5	6	70	3	1600	1100	700	-	3
TCJY156M035#0100	Y	15	35	105	52.5	6	100	3	1400	1000	600	-	3
TCJD226M035#0070	D	22	35	105	77	6	70	3	1800	1300	800	-	2
TCJD226M035#0100	D	22	35	105	77	6	100	3	1500	1100	700	-	2
TCJY226M035#0150	Y	22	35	105	77	6	150	3	1100	800	500	-	3
TCJD336M035#0070	D	33	35	105	115.5	6	70	3	1800	1300	800	-	2
TCJD336M035#0100	D	33	35	105	115.5	6	100	3	1500	1100	700	-	2
TCJE336M035#0055	E	33	35	105	115.5	6	55	3	2100	1500	900	-	3
TCJE336M035#0070	E	33	35	105	115.5	6	70	3	1900	1300	900	-	3
TCJE476M035#0055	E	47	35	105	164.5	6	55	3	2100	1500	900	-	2

RATINGS & PART NUMBER REFERENCE

AVX Part No.	Case Size	Capacitance (µF)	Rated Voltage (V)	Maximum Operating Temperature (°C)	DCL Max. (µA)	DF Max. (%)	ESR Max. @ 100kHz (mΩ)	MSL	100kHz RMS Current (mA)				Product Category
									45°C	85°C	105°C	125°C	
50 Volt @ 85°C													
TCJB684M050#0400	B	0.68	50	105	3.4	6	400	3	600	400	300	-	3
TCJB105M050#0300	B	1.0	50	105	5	6	300	3	600	400	300	-	3
TCJB155M050#0300	B	1.5	50	105	7.5	6	300	3	600	400	300	-	3
TCJC155M050#0300	C	1.5	50	105	7.5	6	300	3	800	600	400	-	3
TCJC225M050#0300	C	2.2	50	105	11	6	300	3	800	600	400	-	3
TCJC335M050#0200	C	3.3	50	105	16.5	8	200	3	900	600	400	-	3
TCJC475M050#0200	C	4.7	50	105	23.5	8	200	3	900	600	400	-	3
TCJX475M050#0250	X	4.7	50	105	23.5	6	250	5	800	600	400	-	2
TCJY475M050#0250	Y	4.7	50	105	23.5	6	250	5	900	600	400	-	2
TCJC685M050#0200	C	6.8	50	105	34	8	200	3	900	600	400	-	3
TCJD685M050#0120	D	6.8	50	105	34	10	120	3	1400	1000	600	-	3
TCJD106M050#0120	D	10	50	105	50	10	120	3	1400	1000	600	-	3
TCJE106M050#0070	E	10	50	105	50	6	70	3	1900	1300	900	-	3
TCJE106M050#0100	E	10	50	105	50	6	100	3	1600	1100	700	-	3
TCJE156M050#0070	E	15	50	105	75	6	70	3	1900	1300	900	-	3
TCJE156M050#0100	E	15	50	105	75	6	100	3	1600	1100	700	-	3
63 Volt @ 85°C													
TCJB474M063#0400	B	0.47	63	105	3	8	400	3	600	400	300	-	3
TCJB684M063#0300	B	0.68	63	105	4.3	8	300	3	600	400	300	-	3
TCJB105M063#0300	B	1.0	63	105	6.3	8	300	3	600	400	300	-	3
TCJC105M063#0300	C	1.0	63	105	6.3	6	300	3	800	600	400	-	3
TCJC155M063#0300	C	1.5	63	105	9.5	6	300	3	800	600	400	-	3
TCJC225M063#0200	C	2.2	63	105	13.9	6	200	3	900	600	400	-	3
TCJC335M063#0200	C	3.3	63	105	20.8	6	200	3	900	600	400	-	3
TCJC475M063#0200	C	4.7	63	105	29.6	6	200	3	900	600	400	-	3
TCJD475M063#0120	D	4.7	63	105	29.6	6	120	3	1400	1000	600	-	3
TCJD685M063#0120	D	6.8	63	105	42.8	6	120	3	1400	1000	600	-	3
TCJE685M063#0100	E	6.8	63	105	42.8	6	100	3	1600	1100	700	-	3
TCJE685M063#0150	E	6.8	63	105	42.8	6	150	3	1300	900	600	-	3
TCJE106M063#0100	E	10	63	105	63	6	100	3	1600	1100	700	-	3
TCJE106M063#0150	E	10	63	105	63	6	150	3	1300	900	600	-	3
75 Volt @ 85°C													
TCJD475M075#0150	D	4.7	75	105	35.3	6	150	3	1200	800	500	-	3
TCJD685M075#0120	D	6.8	75	105	51	6	120	3	1400	1000	600	-	3
100 Volt @ 85°C													
TCJD475M100#0250	D	4.7	100	105	47	8	250	3	900	600	400	-	4
125 Volt @ 85°C													
TCJD335M125#0250	D	3.3	125	105	41.2	8	250	3	900	600	400	-	4

Moisture Sensitivity Level (MSL) is defined according to J-STD-020.

All technical data relates to an ambient temperature of +25°C. Capacitance and DF are measured at 120Hz, 0.5RMS with DC bias of 2.2 volts. DCL is measured at rated voltage after 5 minutes.

ESR allowed to move up to 1.25 times catalog limit post mounting.

For typical weight and composition see page 222.

NOTE: AVX reserves the right to supply a higher voltage rating or tighter tolerance part in the same case size, to the same reliability standards.

RECOMMENDED DERATING FACTOR

Voltage and temperature derating as percentage of Vr

Product Category 1

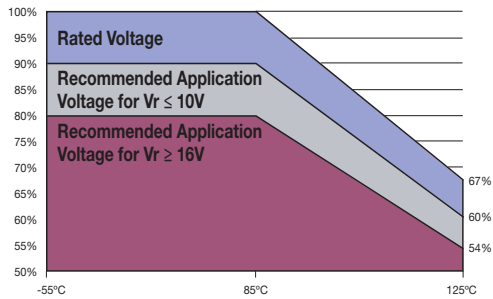

Product Category 2

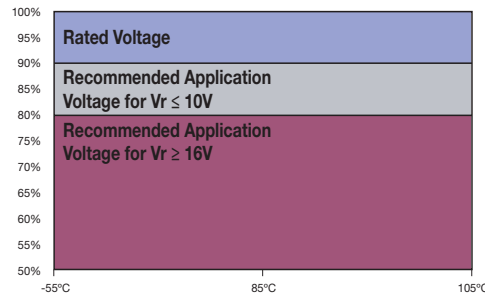

Product Category 3, 4

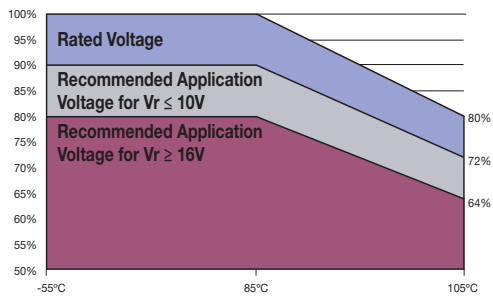

Product Category 5

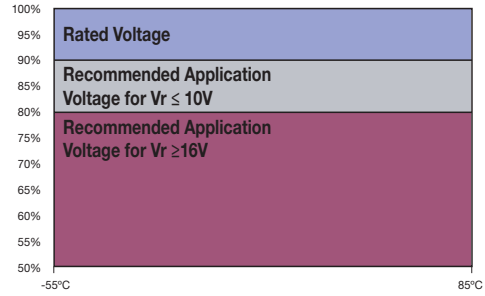

PRODUCT CATEGORY 1 (TEMPERATURE RANGE -55°C TO +125°C)

TEST	Condition			Characteristics						
				Visual examination						
Endurance	Determine after application of rated voltage for 2000 +48/-0 hours at 85±2°C and then leaving 1-2 hours at room temperature. Also determine after application of 125°C temperature, 2/3 rated voltage for 2000 +48/-0 hours and then leaving 1-2 hours at room temperature. Power supply impedance to be ≤ 0.1Ω/V.			no visible damage						
				DCL	1.25 x initial limit					
				ΔC/C	within ±20% of initial value					
				DF	1.5 x initial limit					
				ESR	2 x initial limit					
Storage Life	125°C, 0V, 2000h			no visible damage						
				DCL	2 x initial limit					
				ΔC/C	within ±20% of initial value					
				DF	1.5 x initial limit					
				ESR	2 x initial limit					
Humidity	Determine after storage without applied voltage at 65±2°C and 95±2% relative humidity for 500hrs and then recovery 1-2 hours at room temperature.			no visible damage						
				DCL	3 x initial limit					
				ΔC/C	within +30/-20% of initial value					
				DF	1.5 x initial limit					
				ESR	2 x initial limit					
Temperature Stability	Step	Temperature°C	Duration(min)		+20°C	-55°C	+20°C	+85°C	+125°C	+20°C
	1	+20±2	15							
	2	-55+0/-3	15	DCL	IL*	n/a	IL*	10 x IL*	12.5 x IL*	IL*
	3	+20±2	15	ΔC/C	n/a	+0/-20%	±5%	+20/-0%	+30/-0%	±5%
	4	+85+3/-0	15	DF	IL*	1.5 x IL*	IL*	1.5 x IL*	2 x IL*	IL*
	5	+125+3/-0	15							
6	+20±2	15								
Surge Voltage	Test temperature: 125°C+3/0°C Surge voltage: 1.3x 2/3x rated voltage at 125°C Charge/Discharge resistance: 1000Ω±100Ω Number of cycles: 1000x Cycle duration: 6 min; 30 sec charge, 5 min 30 sec discharge			no visible damage						
				DCL	initial limit					
				ΔC/C	within +10/-20% of initial value for Vr ≤ 10V within +20/-30% of initial value for Vr ≥ 16V					
				DF	1.25 x initial limit					

*Initial Limit

Initial measurement max. 1hr after the removal from dry pack or after pretreatment at 85°C for 24 hours.

PRODUCT CATEGORY 2, 3, 4 (TEMPERATURE RANGE -55°C TO +105°C)

TEST	Condition	Characteristics								
Endurance	Determine after application of rated voltage for 2000 +48/- 0 hours at 85±2°C and then leaving 1-2 hours at room temperature. Also determine after application of 105°C temperature. For CATEGORY 2: Rated voltage for 2000 +48/-0 hours. For CATEGORY 3, 4: 0.8x rated voltage for 2000 +48/-0 hours And then leaving 1-2 hours at room temperature. Power supply impedance to be ≤ 0.1Ω/V.	Visual examination	no visible damage							
		DCL	1.25 x initial limit							
		ΔC/C	within ±20% of initial value							
		DF	1.5 x initial limit							
		ESR	2 x initial limit							
Storage Life	105°C, 0V, 2000h	Visual examination	no visible damage							
		DCL (V _R ≤ 75V)	1.25 x initial limit							
		DCL (V _R > 75V)	2 x initial limit							
		ΔC/C	within ±20% of initial value							
		DF	1.5 x initial limit							
Humidity	Determine after storage without applied voltage at 65±2°C and 95±2% relative humidity for 500hrs and then recovery 1-2 hours at room temperature.	Visual examination	no visible damage							
		DCL	3 x initial limit							
		ΔC/C	within +30/-20% of initial value							
		DF	1.5 x initial limit							
		ESR	2 x initial limit							
Temperature Stability	Step	Temperature°C	Duration(min)							
	1	+20±2	15	+20°C	-55°C	+20°C	+85°C	+105°C	+20°C	
	2	-55+0/-3	15	DCL	IL*	n/a	IL*	10 x IL*	12.5 x IL*	IL*
	3	+20±2	15	ΔC/C	n/a	+0/-20%	±5%	+20/-0%	+30/-0%	±5%
	4	+85+3/-0	15	DF	IL*	1.5 x IL*	IL*	1.5 x IL*	2 x IL*	IL*
	5	+105+3/-0	15							
6	+20±2	15								
Surge Voltage	<u>Test temperature: 105°C +3/0°C</u> For CATEGORY 2: Surge voltage: 1.3x rated voltage at 105°C For CATEGORY 3, 4: Surge voltage: 1.3x 0.8x rated voltage at 105°C Charge/Discharge resistance: 1000±100Ω Number of cycles: 1000x Cycle duration: 6 min; 30 sec charge, 5 min 30 sec discharge	Visual examination	no visible damage							
		DCL	initial limit							
		ΔC/C	within +10/-20% of initial value for V _r ≤ 10V within +20/-30% of initial value for V _r ≥ 16V							
		DF	1.25 x initial limit							

*Initial Limit

Initial measurement max. 1hr after the removal from dry pack or after pretreatment at 85°C for 24 hours.

PRODUCT CATEGORY 5 (TEMPERATURE RANGE -55°C TO +85°C)

TEST	Condition	Characteristics							
Endurance	Determine after application of rated voltage for 2000 +48/-0 hours at 85±2°C and then leaving 1-2 hours at room temperature. Power supply impedance to be ≤ 0.1Ω/V.	Visual examination	no visible damage						
		DCL	1.25 x initial limit						
		ΔC/C	within ±20% of initial value						
		DF	1.5 x initial limit						
		ESR	2 x initial limit						
Storage Life	85°C, 0V, 2000h	Visual examination	no visible damage						
		DCL	1.25 x initial limit						
		ΔC/C	within ±20% of initial value						
		DF	1.5 x initial limit						
		ESR	2 x initial limit						
Humidity	Determine after storage without applied voltage at 65±2°C and 95±2% relative humidity for 500hrs and then recovery 1-2 hours at room temperature.	Visual examination	no visible damage						
		DCL	5 x initial limit						
		ΔC/C	within +40/-20% of initial value						
		DF	1.5 x initial limit						
		ESR	2 x initial limit						
Temperature Stability	Step	Temperature°C	Duration(min)						
	1	+20±2	15	+20°C	-55°C	+20°C	+85°C	+20°C	
	2	-55+0/-3	15	DCL	IL*	n/a	IL*	10 x IL*	IL*
	3	+20±2	15	ΔC/C	n/a	+0/-20%	±5%	+20/-0%	±5%
	4	+85+3/-0	15	DF	IL*	1.5 x IL*	IL*	1.5 x IL*	IL*
5	+20±2	15							
Surge Voltage	<u>Test temperature: 85°C+3/0°C</u> Surge voltage: 1.3 x rated voltage Charge/Discharge resistance: 1000±100Ω Number of cycles: 1000x Cycle duration: 6 min; 30 sec charge, 5 min 30 sec discharge	Visual examination	no visible damage						
		DCL	initial limit						
		ΔC/C	within +10/-20% of initial value for V _r ≤ 10V within +20/-30% of initial value for V _r ≥ 16V						
		DF	1.25 x initial limit						

*Initial Limit

Initial measurement max. 1hr after the removal from dry pack or after pretreatment at 85°C for 24 hours.

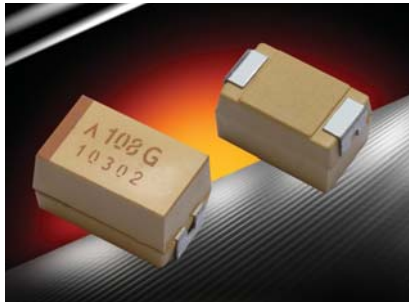

FEATURES

- Conductive polymer electrode, multianode design
- Benign failure mode under recommended use conditions
- Extremely Low ESR
- 3x reflow 260°C compatible
- Volumetric efficiency
- High frequency capacitance retention



Elektra Award 2010



LEAD-FREE

LEAD-FREE COMPATIBLE COMPONENT

RoHS COMPLIANT

SnPb termination option is not RoHS compliant.

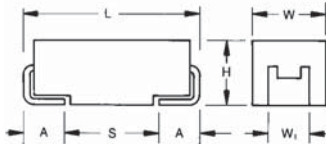

APPLICATIONS

- Telecommunication routers
- Basestations with high power DC/DCs

MARKING

E, V CASE

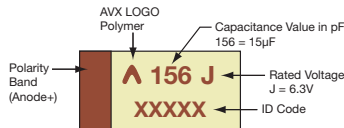

CASE DIMENSIONS: millimeters (inches)

Code	EIA Code	EIA Metric	L±0.20 (0.008)	W+0.20 (0.008) -0.10 (0.004)	H+0.20 (0.008) -0.10 (0.004)	W,±0.20 (0.008)	A+0.30 (0.012) -0.20 (0.008)	S Min.
E	2917	7343-43	7.30 (0.287)	4.30 (0.169)	4.10 (0.162)	2.40 (0.094)	1.30 (0.051)	4.40 (0.173)
V	2924	7361-38	7.30 (0.287)	6.10 (0.240)	3.55 (0.140)	3.10 (0.120)	1.30 (0.051)	4.40 (0.173)

W1 dimension applies to the termination width for A dimensional area only.

HOW TO ORDER

TCM	E	108	M	004	R	0010
Type	Case Size See table above	Capacitance Code pF code: 1st two digits represent significant figures, 3rd digit represents multiplier (number of zeros to follow)	Tolerance M=±20%	Rated DC Voltage 002=2.5Vdc 004=4Vdc 006=6.3Vdc 010=10Vdc 035=35Vdc 100=100Vdc	Packaging R = Pure Tin 7" Reel S = Pure Tin 13" Reel H = Tin Lead 7" Reel (contact manufacturer) K = Tin Lead 13" Reel (contact manufacturer)	ESR in mΩ

TECHNICAL SPECIFICATIONS

Technical Data:	All technical data relate to an ambient temperature of +25°C							
Capacitance Range:	10 µF to 1000 µF							
Capacitance Tolerance:	±20%							
Leakage Current DCL:	0.1CV							
Rated Voltage (V _R)	≤ +85°C:	2.5	4	6.3	10	35	100	
Category Voltage (V _C)	≤ +105°C:	2	3.2	5	8	28	80	
Surge Voltage (V _S)	≤ +85°C:	3.3	5.2	8	13	46	130	
Surge Voltage (V _S)	≤ +105°C:	2.5	4	6	10	35	100	
Temperature Range:	-55°C to +105°C							
Reliability:	1% per 1000 hours at 85°C, V _R with 0.1Ω/V series impedance, 60% confidence level							
Termination Finish:	Sn Plating (standard) and SnPb Plating upon request							

NOTE: Conductive Polymer Capacitors are designed to operate within the limits of the environmental conditions specified for each series. If operated continuously at their maximum temperature and / or humidity limit, or beyond these limits, capacitors may exhibit a parametric shift in capacitance and increases in ESR. These changes may occur earlier if the specified environmental conditions are exceeded. Similarly, their normal operational time period will be significantly extended if their general duty cycle includes operation below maximum temperature within humidity controlled environments. Careful attention should be paid to maximum temperature with associated high humidity environments as well as voltage derating, ripple current and current surges. Please reference the AVX Conductive Polymer Capacitor Guidelines for more information or contact factory for application assistance.

CAPACITANCE AND RATED VOLTAGE RANGE (LETTER DENOTES CASE SIZE)

Capacitance		Rated Voltage DC (V_R) to 85°C					
μF	Code	2.5V (e)	4V (G)	6.3V (J)	10V (A)	35V (V)	100V (A)
10	106						V(50)
22	226					E(25)	
33	336						
47	476						
68	686						
100	107						
150	157						
220	227						
330	337			E(10,15)	E(10,15)		
470	477			E(7,10)			
680	687		E(12)	E(12)			
1000	108	E(6,10)	E(6,8,10,12)				

Available Ratings, (ESR ratings in mOhms in brackets)

Engineering samples - please contact manufacturer

Note: Voltage ratings are minimum values. AVX reserves the right to supply higher ratings in the same case size, to the same reliability standards.

RATINGS & PART NUMBER REFERENCE

AVX Part No.	Case Size	Capacitance (μF)	Rated Voltage (V)	Maximum Operating Temperature ($^{\circ}\text{C}$)	DCL Max. (μA)	DF Max. (%)	ESR Max. @ 100kHz (m Ω)	MSL	100kHz RMS Current (mA)			
									45°C	85°C	105°C	
2.5 Volt @ 85°C												
TCME108M002#0006	E	1000	2.5	105	250	10	6	3	8300	5800	3700	
TCME108M002#0010	E	1000	2.5	105	250	10	10	3	6400	4500	2900	
4 Volt @ 85°C												
TCME687M004#0012	E	680	4	105	272	8	12	3	5800	4100	2600	
TCME108M004#0006	E	1000	4	105	400	8	6	3	8300	5800	3700	
TCME108M004#0008	E	1000	4	105	400	8	8	3	7200	5000	3200	
TCME108M004#0010	E	1000	4	105	400	8	10	3	6400	4500	2900	
TCME108M004#0012	E	1000	4	105	400	8	12	3	5800	4100	2600	
6.3 Volt @ 85°C												
TCME337M006#0010	E	330	6.3	105	198	8	10	3	6400	4500	2900	
TCME337M006#0015	E	330	6.3	105	198	8	15	3	5200	3600	2300	
TCME477M006#0007	E	470	6.3	105	296	10	7	3	7700	5400	3500	
TCME477M006#0010	E	470	6.3	105	296	10	10	3	6400	4500	2900	
TCME687M006#0012	E	680	6.3	105	408	8	12	3	5800	4100	2600	
10 Volt @ 85°C												
TCME337M010#0010	E	330	10	105	330	8	10	3	6400	4500	2900	
TCME337M010#0015	E	330	10	105	330	8	15	3	5200	3600	2300	
35 Volt @ 85°C												
TCME226M035#0025	E	22	35	105	77	8	25	3	4000	2800	1800	
100 Volt @ 85°C												
TCMV106M100#0050	V	10	100	105	100	8	50	3	2900	2000	1300	

Moisture Sensitivity Level (MSL) is defined according to J-STD-020.

All technical data relates to an ambient temperature of +25°C. Capacitance and DF are measured at 120Hz, 0.5RMS with DC bias of 2.2 volts. DCL is measured at rated voltage after 5 minutes.

ESR allowed to move up to 1.25 times catalog limit post mounting.

For typical weight and composition see page 222.

NOTE: AVX reserves the right to supply a higher voltage rating or tighter tolerance part in the same case size, to the same reliability standards.

RECOMMENDED DERATING FACTOR

Voltage and temperature derating as percentage of V_R

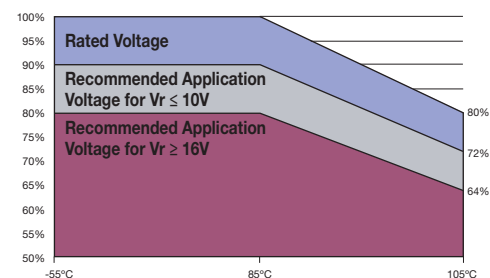

PRODUCT CATEGORY 105°C

TEST	Condition	Characteristics								
Endurance	Determine after application of rated voltage for 2000 +48/-0 hours at 85±2°C and then leaving 1-2 hours at room temperature. Also determine after application of 105°C temperature, category voltage for 2000 +48/-0 hours and then leaving 1-2 hours at room temperature. Power supply impedance to be ≤0.1Ω/V.	Visual examination	no visible damage							
		DCL	1.25 x initial limit							
		ΔC/C	within ±20% of initial value							
		DF	1.5 x initial limit							
		ESR	2 x initial limit							
Storage Life	105°C, 0V, 2000h	Visual examination	no visible damage							
		DCL (V _R ≤ 75V)	1.25 x initial limit							
		DCL (V _R > 75V)	2 x initial limit							
		ΔC/C	within ±20% of initial value							
		DF	1.5 x initial limit							
Humidity	Determine after storage without applied voltage at 65±2°C and 95±2% relative humidity for 500 hours and then recovery 1-2 hours at room temperature.	Visual examination	no visible damage							
		DCL	3 x initial limit							
		ΔC/C	within +30/-20% of initial value							
		DF	1.5 x initial limit							
		ESR	2 x initial limit							
Temperature Stability	Step	Temperature°C	Duration(min)							
	1	+20±2	15							
	2	-55+0/-3	15							
	3	+20±2	15							
	4	+85+3/-0	15							
	5	+105+3/-0	15							
	6	+20±2	15							
				+20°C	-55°C	+20°C	+85°C	+105°C	+20°C	
				DCL	IL*	n/a	IL*	10 x IL*	12.5 x IL*	IL*
				ΔC/C	n/a	+0/-20%	±10%	+20/-0%	+30/-0%	±10%
				DF	IL*	1.5 x IL*	IL*	1.5 x IL*	2 x IL*	IL*
Surge Voltage	Test temperature: 105°C+3/0°C Test voltage: Category voltage at 105°C Surge voltage: 1.3 x category voltage at 105°C Series protection resistance 1000±100Ω Discharge resistance: 1000Ω Number of cycles: 1000x Cycle duration: 6 min; 30 sec charge, 5 min 30 sec discharge	Visual examination	no visible damage							
		DCL	initial limit							
		ΔC/C	within +10/-20% of initial value for V _r ≤ 10V within +20/-30% of initial value for V _r ≥ 16V							
		DF	1.25 x initial limit							

*Initial Limit

Initial measurement max. 1hr after the removal from dry pack or after pretreatment at 85°C for 24 hours.

Highest CV/cc Conductive Polymer Chip Capacitors Undertab

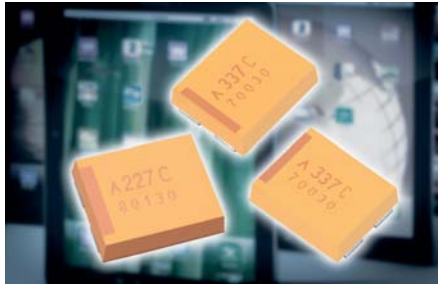

FEATURES

- Highest CV/cc in broad range of low profiles
- Conductive polymer electrode
- Benign failure mode under recommended use conditions
- Lower ESR
- Undertab terminations layout:
 - High Volumetric Efficiency
 - High PCB assembly density
 - High capacitance in smaller dimensions
- 3x reflow 260°C compatible
- 10 case sizes available



APPLICATIONS

- Consumer applications (e.g. mobiles, MP3 etc.)

CASE DIMENSIONS: millimeters (inches)

Code	EIA Code	EIA Metric	L±0.20 (0.008)	W+0.20 (0.008) -0.10 (0.004)	H max.	W _P ±0.10 (0.004)	W _N ±0.10 (0.004)	A _P ±0.10 (0.004)	A _N ±0.10 (0.004)	S Min.
N	0805	2012-10	2.05 (0.081)	1.30 (0.051)	1.00 (0.039)	1.00 (0.039)	1.00 (0.039)	0.85 (0.033)	0.85 (0.033)	0.40 (0.016)
O	1206	3216-06	3.20 (0.126)	1.60 (0.063)	0.60 (0.024)	1.30 (0.051)	1.30 (0.051)	1.15 (0.045)	1.15 (0.045)	0.90 (0.035)
K	1206	3216-10	3.20 (0.126)	1.60 (0.063)	1.00 (0.039)	1.30 (0.051)	1.30 (0.051)	1.15 (0.045)	1.15 (0.045)	0.90 (0.035)
S	1206	3216-12	3.20 (0.126)	1.60 (0.063)	1.20 (0.047)	1.30 (0.051)	1.30 (0.051)	1.15 (0.045)	1.15 (0.045)	0.90 (0.035)
L	1210	3528-10	3.50 (0.138)	2.80 (0.110)	1.00 (0.039)	2.50 (0.098)	2.10 (0.083)	1.15 (0.045)	1.35 (0.053)	1.00 (0.039)
T	1210	3528-12	3.50 (0.138)	2.80 (0.110)	1.20 (0.047)	2.50 (0.098)	2.10 (0.083)	1.15 (0.045)	1.35 (0.053)	1.00 (0.039)
H	1210	3528-15	3.50 (0.138)	2.80 (0.110)	1.50 (0.059)	2.50 (0.098)	2.10 (0.083)	1.15 (0.045)	1.35 (0.053)	1.00 (0.039)
X	2917	7343-15	7.30 (0.287)	4.30 (0.169)	1.50 (0.059)	3.25 (0.128)	3.25 (0.128)	2.00 (0.079)	3.20 (0.126)	2.10 (0.083)
3	2924	7361-15	7.30 (0.287)	6.10 (0.240)	1.50 (0.059)	4.75 (0.187)	4.75 (0.187)	2.00 (0.079)	3.20 (0.126)	2.10 (0.083)
4	2924	7361-20	7.30 (0.287)	6.10 (0.240)	2.00 (0.079)	4.75 (0.187)	4.75 (0.187)	2.00 (0.079)	3.20 (0.126)	2.10 (0.083)

Engineering samples

MARKING

H, K, L, O, S, T, X CASE

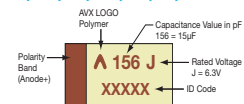

N CASE

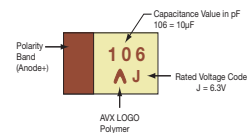

3, 4 CASE

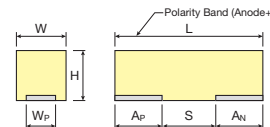
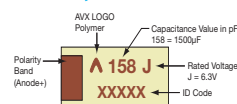

HOW TO ORDER

TCN

Type

L

Case Size
See table above

157

Capacitance Code
pF code: 1st two digits represent significant figures, 3rd digit represents multiplier (number of zeros to follow)

M

Tolerance
M = ±20%

006

Rated DC Voltage
006 = 6.3Vdc
016 = 16Vdc
020 = 20Vdc
025 = 25Vdc
035 = 35Vdc
050 = 50Vdc

R

Packaging
R = Pure Tin 7" Reel
S = Pure Tin 13" Reel

0200

ESR in mΩ

TECHNICAL SPECIFICATIONS

Technical Data:

All technical data relate to an ambient temperature of +25°C

Capacitance Range:	1.0 µF to 1500 µF									
Capacitance Tolerance:	±20%									
Leakage Current DCL:	0.1CV									
Rated Voltage (V _R)	≤ +85°C:	4	6.3	10	16	20	25	35	50	
Category Voltage (V _C)	≤ +105°C:	3.2	5	8	13	16	20	28	40	
Surge Voltage (V _S)	≤ +85°C:	5.2	8	13	21	26	33	46	65	
Surge Voltage (V _S)	≤ +105°C:	4	6	10	16	20	25	35	50	
Temperature Range:	-55°C to +105°C									
Reliability:	1% per 1000 hours at 85°C, V _R with 0.1Ω/V series impedance 60% confidence level									

NOTE: Conductive Polymer Capacitors are designed to operate within the limits of the environmental conditions specified for each series. If operated continuously at their maximum temperature and / or humidity limit, or beyond these limits, capacitors may exhibit a parametric shift in capacitance and increases in ESR. These changes may occur earlier if the specified environmental conditions are exceeded. Similarly, their normal operational time period will be significantly extended if their general duty cycle includes operation below maximum temperature within humidity controlled environments. Careful attention should be paid to maximum temperature with associated high humidity environments as well as voltage derating, ripple current and current surges. Please reference the AVX Conductive Polymer Capacitor Guidelines for more information or contact factory for application assistance.

CAPACITANCE AND RATED VOLTAGE RANGE (LETTER DENOTES CASE SIZE)

Capacitance		Rated Voltage DC to 85°C / 0.66DC to 105°C							
μF	Code	4V (G)	6.3V (J)	10V (A)	16V (C)	20V (D)	25V (E)	35V (V)	50V (T)
1.0	105							O*	N(1500)
4.7	475						N(500)	L(300)/T(200)	
10	106				O(500)		K(350)/S(350)	T(200)	
15	156			N(500)*					
22	226			N(500)*			T(200)/X*	X(100)*	
33	336	N(500)*	K(500)*N(500)*	K(500)*N(500)*	L(200)/T(200)		T(250)		
47	476	N(500)*	K(500)*M(250)* N(500)*	K(500)*S(500)*	L(250)/T(150,200)		X(100)	X(100)	
68	686	K(500)*N(500)*	K(500)*S(500)*	G(150)*L(150)* S(500)*					
100	107	K(500)*S(500)*	G(200)* K(200,250) L(200)/S(250)	G(150)*L(150)* S(150)*T(150)*			3(70)/4(100)	3(200)/4(100)	
150	157	G(200)*L(200)* S(500)*	K(200)*L(200) S(250)/T(200)	G(150)*H(150)* T(150)*	X(100)		4(70)		
220	227	G(200)*L(150)* S(200)*T(150)*	H(170)/H(100,200)* T(200)	H(150)*	4(70)	4(100)	4(100)		
330	337	H(150)*T(150)*	H(200)*		4(70)	4(100)			
470	477	H(150)*	X(50)		4(100)				
1000	108		X(200)/3(100) 4(55)						
1500	158		4(55)						

Released ratings, (ESR ratings in mOhms in parenthesis)

Engineering samples - please contact AVX

*Ratings under development - subject to change

Note: Voltage ratings are minimum values. AVX reserves the right to supply higher ratings in the same case size, to the same reliability standards.

RATINGS & PART NUMBER REFERENCE

AVX Part No.	Case Size	Cap (μF)	Rated Voltage (V)	Maximum Operating Temperature (°C)	DCL Max. (μA)	DF Max. (%)	ESR Max. @ 100kHz (mΩ)	MSL	100kHz RMS Current (mA)			Product Category
									45°C	85°C	105°C	
6.3 Volt @ 85°C												
TCNK107M006#0200	K	100	6.3	105	60	10	200	5	700	500	300	3
TCNK107M006#0250	K	100	6.3	105	60	10	250	5	600	400	300	3
TCNL107M006#0200	L	100	6.3	105	60	10	200	5	700	500	300	3
TCNS107M006#0250	S	100	6.3	85	60	10	250	3	600	400	-	5
TCNL157M006#0200	L	150	6.3	105	90	10	200	5	700	500	300	3
TCNS157M006#0250	S	150	6.3	85	90	10	250	3	600	400	-	5
TCNT157M006#0200	T	150	6.3	105	90	10	200	3	700	500	300	3
TCNH227M006#0170	H	220	6.3	105	132	10	170	5	800	600	400	3
TCNT227M006#0200	T	220	6.3	85	132	10	200	3	700	500	-	5
TCNX477M006#0050	X	470	6.3	85	282	10	50	3	1900	1300	-	5
TCNX108M006#0200	X	1000	6.3	85	600	30	200	3	900	600	-	5
TCN3108M006#0100	3	1000	6.3	105	600	20	100	4	1200	840	480	3
TCN4108M006#0055	4	1000	6.3	85	600	20	55	4	1860	1302	-	5
TCN4158M006#0055	4	1500	6.3	85	900	20	55	4	1860	1302	-	5
16 Volt @ 85°C												
TCNO106M016#0500	O	10	16	105	16	10	500	3	400	300	200	3
TCNL336M016#0200	L	33	16	85	52.8	6	200	5	700	500	-	5
TCNT336M016#0200	T	33	16	85	52.8	6	200	3	700	500	-	5
TCNL476M016#0250	L	47	16	85	75.2	6	250	5	600	400	-	5
TCNT476M016#0150	T	47	16	85	75.2	6	150	3	800	600	-	5
TCNT476M016#0200	T	47	16	85	75.2	6	200	3	700	500	-	5
TCNX157M016#0100	X	150	16	85	240	6	100	3	1300	900	-	5
TCN4227M016#0070	4	220	16	105	352	20	70	4	1650	1155	660	2
TCN4337M016#0070	4	330	16	105	528	20	70	4	1650	1155	660	3
TCN4477M016#0100	4	470	16	85	752	20	100	4	1380	966	-	5
20 Volt @ 85°C												
TCN4227M020#0100	4	220	20	85	440	10	100	4	1380	966	-	5
TCN4337M020#0100	4	330	20	85	660	20	100	4	1380	966	-	5
25 Volt @ 85°C												
TCNN475M025#0500	N	4.7	25	105	11.8	10	500	3	400	300	200	3
TCNK106M025#0350	K	10	25	105	25	10	350	5	500	400	200	3
TCNS106M025#0350	S	10	25	105	25	10	350	5	500	400	200	3
TCNT226M025#0200	T	22	25	105	55	6	200	3	700	500	300	3
TCNT336M025#0250	T	33	25	105	82.5	10	250	5	600	400	300	3
TCNX476M025#0100	X	47	25	105	117.5	6	100	3	1300	900	600	2
TCN3107M025#0070	3	100	25	105	250	6	70	4	1440	1008	576	2
TCN4107M025#0100	4	100	25	105	250	6	100	4	1380	966	552	2
TCN4157M025#0070	4	150	25	105	375	6	70	4	1650	1155	660	2
TCN4227M025#0100	4	220	25	105	550	10	100	4	1380	966	552	3
35 Volt @ 85°C												
TCNL475M035#0300	L	4.7	35	105	16.5	6	300	5	600	400	300	2
TCNT475M035#0200	T	4.7	35	105	16.5	10	200	5	700	500	300	3
TCNT106M035#0200	T	10	35	105	35	10	200	5	700	500	300	3
TCNX476M035#0100	X	47	35	105	164.5	10	100	3	1300	900	600	2
TCN3107M035#0200	3	100	35	85	350	10	200	5	850	595	-	5
TCN4107M035#0100	4	100	35	105	350	10	100	4	1380	966	552	3
50 Volt @ 85°C												
TCNN105M050#1500	N	1	50	105	5	10	1500	3	200	100	100	3

Moisture Sensitivity Level (MSL) is defined according to J-STD-020.

All technical data relates to an ambient temperature of +25°C. Capacitance and DF are measured at 120Hz, 0.5RMS with DC bias of 2.2 volts. DCL is measured at rated voltage after 5 minutes.

ESR allowed to move up to 1.25 times catalog limit post mounting.

For typical weight and composition see page 222.

NOTE: AVX reserves the right to supply a higher voltage rating or tighter tolerance part in the same case size, to the same reliability standards.

RECOMMENDED DERATING FACTOR

Voltage and temperature derating as percentage of Vr

Product Category 2

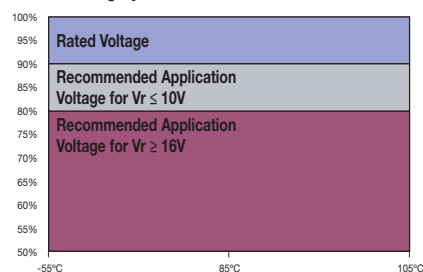

Product Category 3

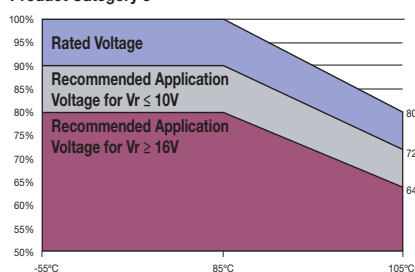

Product Category 5

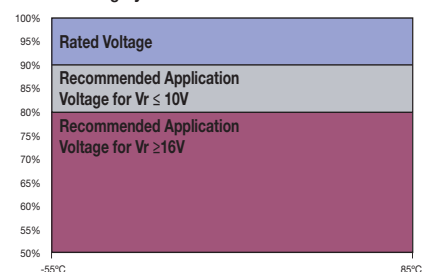

PRODUCT CATEGORY 2, 3 (TEMPERATURE RANGE -55°C TO +105°C)

TEST	Condition	Characteristics								
Endurance	Determine after application of rated voltage for 2000 +48/-0 hours at 85±2°C and then leaving 1-2 hours at room temperature. Also determine after application of 105°C temperature. For CATEGORY 2: Rated voltage for 2000 +48/-0 hours For CATEGORY 3: 0.8x rated voltage for 2000 +48/-0 hours And then leaving 1-2 hours at room temperature. Power supply impedance to be ≤ 0.1Ω/V.	Visual examination	no visible damage							
		DCL	1.25 x initial limit							
		ΔC/C	within ±20% of initial value							
		DF	1.5 x initial limit							
		ESR	2 x initial limit							
Storage Life	105°C, 0V, 2000h	Visual examination	no visible damage							
		DCL (V _R ≤ 75V)	1.25 x initial limit							
		DCL (V _R > 75V)	2 x initial limit							
		ΔC/C	within ±20% of initial value							
		DF	1.5 x initial limit							
		ESR	2 x initial limit							
Humidity	Determine after storage without applied voltage at 65±2°C and 95±2% relative humidity for 500hrs and then recovery 1-2 hours at room temperature.	Visual examination	no visible damage							
		DCL	3 x initial limit							
		ΔC/C	within +30/-20% of initial value							
		DF	1.5 x initial limit							
		ESR	2 x initial limit							
Temperature Stability	Step	Temperature°C	Duration(min)	+20°C	-55°C	+20°C	+85°C	+105°C	+20°C	
	1	+20±2	15							
	2	-55+0/-3	15	DCL	IL*	n/a	IL*	10 x IL*	12.5 x IL*	IL*
	3	+20±2	15	ΔC/C	n/a	+0/-20%	±5%	+20/-0%	+30/-0%	±5%
	4	+85+3/-0	15	DF	IL*	1.5 x IL*	IL*	1.5 x IL*	2 x IL*	IL*
	5	+105+3/-0	15							
	6	+20±2	15							
Surge Voltage	Test temperature: 105°C+3/0°C For CATEGORY 2: Surge voltage: 1.3x rated voltage at 105°C For CATEGORY 3: Surge voltage: 1.3x 0.8x rated voltage at 105°C Charge/Discharge resistance: 1000±100Ω Number of cycles: 1000x Cycle duration: 6 min; 30 sec charge, 5 min 30 sec discharge	Visual examination	no visible damage							
		DCL	initial limit							
		ΔC/C	within +10/-20% of initial value for V _r ≤ 10V within +20/-30% of initial value for V _r ≥ 16V							
		DF	1.25 x initial limit							

*Initial Limit

Initial measurement max. 1hr after the removal from dry pack or after pretreatment at 85°C for 24 hours.

PRODUCT CATEGORY 5 (TEMPERATURE RANGE -55°C TO +85°C)

TEST	Condition	Characteristics							
Endurance	Determine after application of rated voltage for 2000 +48/-0 hours at 85±2°C and then leaving 1-2 hours at room temperature. Power supply impedance to be ≤ 0.1Ω/V.	Visual examination	no visible damage						
		DCL	1.25 x initial limit						
		ΔC/C	within ±20% of initial value						
		DF	1.5 x initial limit						
		ESR	2 x initial limit						
Storage Life	85°C, 0V, 2000h	Visual examination	no visible damage						
		DCL	1.25 x initial limit						
		ΔC/C	within ±20% of initial value						
		DF	1.5 x initial limit						
		ESR	2 x initial limit						
Humidity	Determine after storage without applied voltage at 65±2°C and 95±2% relative humidity for 500hrs and then recovery 1-2 hours at room temperature.	Visual examination	no visible damage						
		DCL	5 x initial limit						
		ΔC/C	within +40/-20% of initial value						
		DF	1.5 x initial limit						
		ESR	2 x initial limit						
Temperature Stability	Step	Temperature°C	Duration(min)	+20°C	-55°C	+20°C	+85°C	+20°C	
	1	+20±2	15						
	2	-55+0/-3	15	DCL	IL*	n/a	IL*	10 x IL*	IL*
	3	+20±2	15	ΔC/C	n/a	+0/-20%	±5%	+20/-0%	±5%
	4	+85+3/-0	15	DF	IL*	1.5 x IL*	IL*	1.5 x IL*	IL*
	5	+20±2	15						
Surge Voltage	Test temperature: 85+3/0°C Surge voltage: 1.3x rated voltage Charge/Discharge resistance: 1000±100Ω Number of cycles: 1000x Cycle duration: 6 min; 30 sec charge, 5 min 30 sec discharge	Visual examination	no visible damage						
		DCL	initial limit						
		ΔC/C	within +10/-20% of initial value for V _r ≤ 10V within +20/-30% of initial value for V _r ≥ 16V						
		DF	1.25 x initial limit						

*Initial Limit

Initial measurement max. 1hr after the removal from dry pack or after pretreatment at 85°C for 24 hours.

J-CAP™ Series



Highest Joules/cc Conductive Polymer Solid Electrolytic Chip Capacitors



FEATURES

- Highest Energy per volume
- Conductive polymer electrode
- Benign failure mode under recommended use conditions
- Low ESR
- Undertab terminations layout:
 - High Volumetric Efficiency
 - Low profile case sizes
 - High capacitance in smaller dimensions
 - Close positioning of several parts for efficient high density PCB layout
- 3x reflow 260°C compatible



APPLICATIONS

- Power backup for SSDs (MLC, SLC, EFD, PCIe), battery-powered portable equipment, industrial alarms, smart power meters, and mobile devices.

CASE DIMENSIONS: millimeters (inches)

Code	EIA Code	EIA Metric	L±0.20 (0.008)	W+0.20 (0.008) -0.10 (0.004)	H max.	W _P ±0.10 (0.004)	W _N ±0.10 (0.004)	A _P ±0.10 (0.004)	A _N ±0.10 (0.004)	S Min.
L	1210	3528-10	3.50 (0.138)	2.80 (0.110)	1.00 (0.039)	2.50 (0.098)	2.10 (0.083)	1.15 (0.045)	1.35 (0.053)	1.00 (0.039)
T	1210	3528-12	3.50 (0.138)	2.80 (0.110)	1.20 (0.047)	2.50 (0.098)	2.10 (0.083)	1.15 (0.045)	1.35 (0.053)	1.00 (0.039)
H	1210	3528-15	3.50 (0.138)	2.80 (0.110)	1.50 (0.059)	2.50 (0.098)	2.10 (0.083)	1.15 (0.045)	1.35 (0.053)	1.00 (0.039)
X	2917	7343-15	7.30 (0.287)	4.30 (0.169)	1.50 (0.059)	3.25 (0.128)	3.25 (0.128)	2.00 (0.079)	3.20 (0.126)	2.10 (0.083)
3	2924	7361-15	7.30 (0.287)	6.10 (0.240)	1.50 (0.059)	4.75 (0.187)	4.75 (0.187)	2.00 (0.079)	3.20 (0.126)	2.10 (0.083)
4	2924	7361-20	7.30 (0.287)	6.10 (0.240)	2.00 (0.079)	4.75 (0.187)	4.75 (0.187)	2.00 (0.079)	3.20 (0.126)	2.10 (0.083)

MARKING

3, 4 CASE

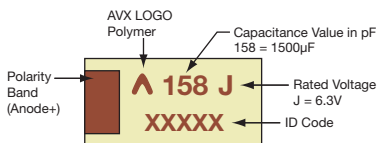

H, L, T, X CASE

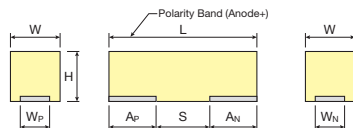
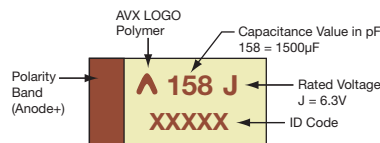

MAXIMUM ENERGY PER CASE SIZE

Case Size	Approved (mJ)
L	1.8
T	6.5
H	2.6
X	18.2
3	38.8
4	52.0

HOW TO ORDER

TCN

Type

4

Case Size
See table above

158

Capacitance Code
pF code: 1st two digits represent significant figures, 3rd digit represents multiplier (number of zeros to follow)

M

Tolerance
M = ±20%

006

Rated DC Voltage
006 = 6.3Vdc
016 = 16Vdc
020 = 20Vdc
025 = 25Vdc
035 = 35Vdc
050 = 50Vdc

R

Packaging
R = Pure Tin 7" Reel

0055

ESR in mΩ

TECHNICAL SPECIFICATIONS

Technical Data:	All technical data relate to an ambient temperature of +25°C							
Capacitance Range:	4.7 μF to 1500 μF							
Capacitance Tolerance:	±20%							
Leakage Current DCL:	0.1CV							
Rated Voltage (V _R)	≤ +85°C:	6.3	16	20	25	35	50	
Surge Voltage (V _S)	≤ +85°C:	8	21	26	33	46	65	
Temperature Range:	-55°C to +105°C							
Reliability:	1% per 1000 hours at 85°C, V _R with 0.1Ω/V series impedance 60% confidence level							

NOTE: Conductive Polymer Capacitors are designed to operate within the limits of the environmental conditions specified for each series. If operated continuously at their maximum temperature and / or humidity limit, or beyond these limits, capacitors may exhibit a parametric shift in capacitance and increases in ESR. These changes may occur earlier if the specified environmental conditions are exceeded. Similarly, their normal operational time period will be significantly extended if their general duty cycle includes operation below maximum temperature within humidity controlled environments. Careful attention should be paid to maximum temperature with associated high humidity environments as well as voltage derating, ripple current and current surges. Please reference the AVX Conductive Polymer Capacitor Guidelines for more information or contact factory for application assistance.

CAPACITANCE AND RATED VOLTAGE RANGE (LETTER DENOTES CASE SIZE)

Capacitance		Rated Voltage DC to 85°C, [mJ]				
μF	Code	6.3V (J)	16V (C)	20V (D)	25V (E)	35V (V)
4.7	475					L(300)/T(200) [1.8]
10	106					T(200) [3.9]
22	226				T(200) [4.3]	
33	336		T(200) [3.3]		T(250) [6.5]	
47	476		T(150,200) [4.7]		X(100) [9.2]	X(100) [18.2]
100	107				3(70)/4(100) [19.6]	3(200)/4(100) [38.8]
150	157	T(200) [1.7]	X(100) [14.9]		4(70) [29.3]	
220	227	H(170) [2.6]	4(70) [21.8]	4(100) [34.7]	4(100) [43.0]	
330	337		4(70) [32.7]	4(100) [52.0]		
470	477	X(50) [5.4]				
1000	108	3(100) [11.6] 4(55)				
1500	158	4(55) [17.4]				

Released ratings (ESR ratings in mOhms in parenthesis) [Energy in mJ]

Engineering samples - please contact AVX

*Ratings under development – subject to change

Note: Voltage ratings are minimum values. AVX reserves the right to supply higher ratings in the same case size, to the same reliability standards.

RATINGS & PART NUMBER REFERENCE

AVX Part No.	Case Size	Capacitance (µF)	Rated Voltage (V)	Maximum Operating Temperature (°C)	DCL Max. (µA)	DF Max. (%)	ESR Max. @ 100kHz (mΩ)	MSL	Product Category	ENERGY		
										Energy (mJ)	Energy/volume (mJ/cm³)	Energy/area (mJ/cm²)
6.3 Volt @ 85°C												
TCNT157M006#0200	T	150	6.3	105	90	10	200	3	3	1.7	147	17.7
TCNH227M006#0170	H	220	6.3	105	132	10	170	5	3	2.6	173	26.0
TCNX477M006#0050	X	470	6.3	85	282	10	50	3	5	5.4	115	17.3
TCN3108M006#0100	3	1000	6.3	105	600	20	100	4	3	11.6	173	26.0
TCN4108M006#0055	4	1000	6.3	85	600	20	55	4	5	11.6	130	26.0
TCN4158M006#0055	4	1500	6.3	85	900	20	55	4	5	17.4	195	39.0
16 Volt @ 85°C												
TCNT336M016#0200	T	33	16	85	52.8	6	200	3	5	3.3	277	33.4
TCNT476M016#0150	T	47	16	85	75.2	6	150	3	5	4.7	395	47.6
TCNT476M016#0200	T	47	16	85	75.2	6	200	3	5	4.7	395	47.6
TCNX157M016#0100	X	150	16	85	240	6	100	3	5	14.9	316	47.4
TCN4227M016#0070	4	220	16	105	352	20	70	4	2	21.8	245	49.0
TCN4337M016#0070	4	330	16	105	528	20	70	4	3	32.7	367	73.5
20 Volt @ 85°C												
TCN4227M020#0100	4	220	20	85	440	10	100	4	5	27.2	305	61.1
TCN4337M020#0100	4	330	20	85	660	20	100	4	5	40.8	457	91.6
25 Volt @ 85°C												
TCNT226M025#0200	T	22	25	105	55	6	200	3	3	4.3	364	43.9
TCNT336M025#0250	T	33	25	105	82.5	10	250	5	3	6.5	547	65.8
TCNX476M025#0100	X	47	25	105	117.5	6	100	3	2	9.2	195	29.3
TCN3107M025#0070	3	100	25	105	250	6	70	4	2	19.6	293	43.9
TCN4107M025#0100	4	100	25	105	250	6	100	4	2	19.6	219	43.9
TCN4157M025#0070	4	150	25	105	375	6	70	4	2	29.3	329	65.9
TCN4227M025#0100	4	220	25	105	550	10	100	4	3	43.0	483	96.7
35 Volt @ 85°C												
TCNL475M035#0300	L	4.7	35	105	16.5	6	300	5	2	1.8	186	18.6
TCNT475M035#0200	T	4.7	35	105	16.5	10	200	5	3	1.8	154	18.6
TCNT106M035#0200	T	10	35	105	35	10	200	5	3	3.9	328	39.5
TCNX476M035#0100	X	47	35	105	165	10	100	3	2	18.2	387	58.0
TCN3107M035#0200	3	100	35	85	350	10	200	5	5	38.8	580	87.1
TCN4107M035#0100	4	100	35	105	350	10	100	4	3	38.8	435	87.1

Energy is calculated by this formula (consider derating factor):

$$\text{Energy} = \frac{1}{2} C \times ((V_r \times X)^2 - V_x^2)$$

where C = Capacitance

V_r = Rated Voltage

X = Recommended derating factor

V_x = 3V (invariable)

Moisture Sensitivity Level (MSL) is defined according to J-STD-020.

All technical data relates to an ambient temperature of +25°C. Capacitance is measured at 120Hz, 0.5RMS with DC bias of 2.2 volts. DCL is measured at rated voltage after 5 minutes.

ESR allowed to move up to 1.25 times catalog limit post mounting.

For typical weight and composition see page 222.

NOTE: AVX reserves the right to supply a higher voltage rating in the same case size, to the same reliability standards.

RECOMMENDED DERATING FACTOR

Voltage and temperature derating as percentage of V_r

Product Category 2

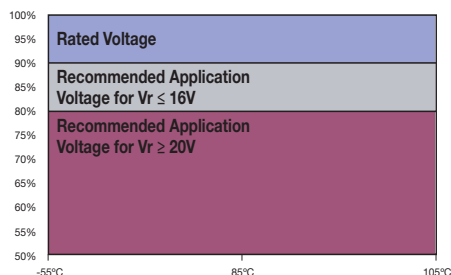

Product Category 3

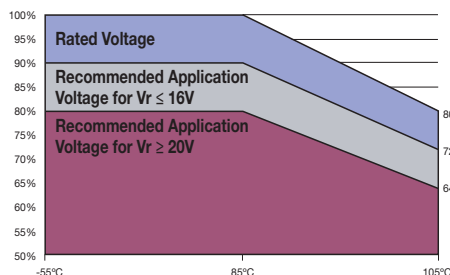

Product Category 5

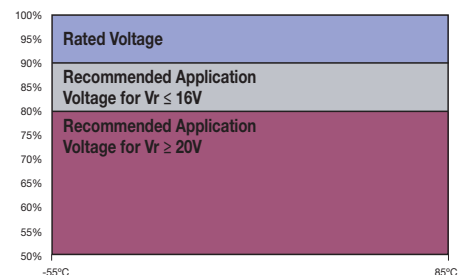

PRODUCT CATEGORY 2, 3 (TEMPERATURE RANGE -55°C TO +105°C)

TEST	Condition	Characteristics								
Endurance	Determine after application of rated voltage for 2000 +48/-0 hours at 85±2°C and then leaving 1-2 hours at room temperature. Also determine after application of 105°C temperature, category voltage for 2000 +48/-0 hours and then leaving 1-2 hours at room temperature. Power supply impedance to be ≤ 0.1Ω/V.	Visual examination	no visible damage							
		DCL	1.25 x initial limit							
		ΔC/C	within +10/-20% of initial value for Vr ≤ 16V within ±20% of initial value for Vr ≥ 20V							
		DF	1.5 x initial limit							
		ESR	2 x initial limit							
Storage Life	105°C, 0V, 2000h	Visual examination	no visible damage							
		DCL	1.25 x initial limit							
		ΔC/C	within +10/-20% of initial value for Vr ≤ 16V within ±20% of initial value for Vr ≥ 20V							
		DF	1.5 x initial limit							
		ESR	2 x initial limit							
Humidity	Determine after storage without applied voltage at 65±2°C and 95±2% relative humidity for 500 hours and then recovery 1-2 hours at room temperature.	Visual examination	no visible damage							
		DCL	3 x initial limit							
		ΔC/C	within +30/-20% of initial value							
		DF	1.5 x initial limit							
		ESR	2 x initial limit							
Temperature Stability	Step	Temperature°C	Duration(min)							
	1	+20±2	15	+20°C	-55°C	+20°C	+85°C	+105°C	+20°C	
	2	-55+0/-3	15	DCL	IL*	n/a	IL*	10 x IL*	12.5 x IL*	IL*
	3	+20±2	15	ΔC/C	n/a	+0/-20%	±5%	+20/-0%	+30/-0%	±5%
	4	+85+3/-0	15	DF	IL*	1.5 x IL*	IL*	1.5 x IL*	2 x IL*	IL*
	5	+105+3/-0	15							
6	+20±2	15								
Surge Voltage	Test temperature: 105°C+3/0°C Test voltage: Category voltage at 105°C Surge voltage: 1.3 x category voltage at 105°C Series protection resistance 1000±100Ω Discharge resistance: 1000Ω Number of cycles: 1000x Cycle duration: 6 min; 30 sec charge, 5 min 30 sec discharge	Visual examination	no visible damage							
		DCL	initial limit							
		ΔC/C	within +10/-20% of initial value for Vr ≤ 16V within +20/-30% of initial value for Vr ≥ 20V							
		DF	1.25 x initial limit							

*Initial Limit

Initial measurement max. 1hr after the removal from dry pack or after pretreatment at 85°C for 24 hours.

PRODUCT CATEGORY 5 (TEMPERATURE RANGE -55°C TO +85°C)

TEST	Condition	Characteristics							
Endurance	Determine after application of rated voltage for 2000 +48/-0 hours at 85±2°C and then leaving 1-2 hours at room temperature. Power supply impedance to be ≤ 0.1Ω/V.	Visual examination	no visible damage						
		DCL	1.25 x initial limit						
		ΔC/C	within +10/-20% of initial value for Vr ≤ 16V within ±20% of initial value for Vr ≥ 20V						
		DF	1.5 x initial limit						
		ESR	2 x initial limit						
Storage Life	85°C, 0V, 2000h	Visual examination	no visible damage						
		DCL	1.25 x initial limit						
		ΔC/C	within +10/-20% of initial value for Vr ≤ 16V within ±20% of initial value for Vr ≥ 20V						
		DF	1.5 x initial limit						
		ESR	2 x initial limit						
Humidity	Determine after storage without applied voltage at 65±2°C and 95±2% relative humidity for 500 hours and then recovery 1-2 hours at room temperature.	Visual examination	no visible damage						
		DCL	5 x initial limit						
		ΔC/C	within +40/-20% of initial value						
		DF	1.5 x initial limit						
		ESR	2 x initial limit						
Temperature Stability	Step	Temperature°C	Duration(min)						
	1	+20±2	15	+20°C	-55°C	+20°C	+85°C	+20°C	
	2	-55+0/-3	15	DCL	IL*	n/a	IL*	10 x IL*	IL*
	3	+20±2	15	ΔC/C	n/a	+0/-20%	±5%	+20/-0%	±5%
	4	+85+3/-0	15	DF	IL*	1.5 x IL*	IL*	1.5 x IL*	IL*
	5	+20±2	15						
Surge Voltage	Test temperature: 85+3/0°C Test voltage: Rated voltage Surge voltage: 1.3 x rated voltage Series protection resistance 1000±100Ω. Discharge resistance: 1000Ω Number of cycles: 1000x Cycle duration: 6 min; 30 sec charge, 5 min 30 sec discharge	Visual examination	no visible damage						
		DCL	initial limit						
		ΔC/C	within +10/-20% of initial value for Vr ≤ 16V within +20/-30% of initial value for Vr ≥ 20V						
		DF	1.25 x initial limit						

*Initial Limit

Initial measurement max. 1hr after the removal from dry pack or after pretreatment at 85°C for 24 hours.

F38 Series



Conductive Polymer, Miniature, Undertab Solid Electrolytic Chip Capacitors

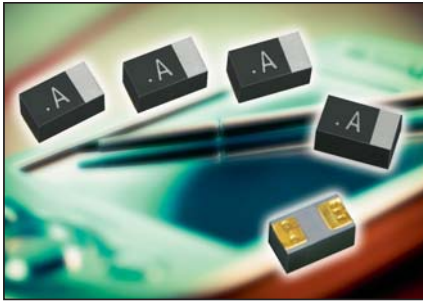

FEATURES

- Conductive polymer electrode
- Benign failure mode under recommended use conditions
- Compliant to the RoHS2 directive 2011/65/EU
- SMD facedown
- Small and low profile
- High volumetric efficiency



APPLICATIONS

- Smartphone
- Tablet PC
- Wireless module
- Portable game

CASE DIMENSIONS: millimeters (inches)

Code	EIA Code	EIA Metric	L	W ₁	W ₂	H	S ₁	S ₂
M	0603	1608-09	1.60 ^{+0.20} _{-0.10} (0.063 ^{+0.008} _{-0.004})	0.85 ^{+0.20} _{-0.10} (0.033 ^{+0.008} _{-0.004})	0.65±0.10 (0.026±0.004)	0.80±0.10 ^{**} (0.031±0.004)	0.50±0.10 (0.020±0.004)	0.60±0.10 (0.024±0.004)
S	0805	2012-09	2.00 ^{+0.20} _{-0.10} (0.079 ^{+0.008} _{-0.004})	1.25 ^{+0.20} _{-0.10} (0.049 ^{+0.008} _{-0.004})	0.90±0.10 (0.035±0.004)	0.80±0.10 (0.031±0.004)	0.50±0.10 (0.020±0.004)	1.00±0.10 (0.039±0.004)
U	0402	1106-06	1.10±0.05 (0.043±0.002)	0.60±0.05 (0.024±0.002)	0.35±0.05 (0.014±0.002)	0.55±0.05 (0.022±0.002)	0.30±0.05 (0.012±0.002)	0.50±0.05 (0.020±0.002)

*1 F380J476MMAAXE: 1.0mm Max.

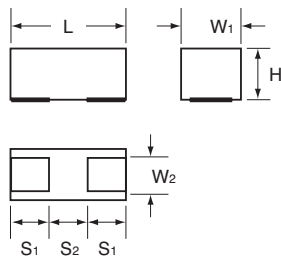

MARKING

U CASE



M CASE



Rated Voltage Code

S CASE



Rated Voltage Code

*Capacitance Code

HOW TO ORDER

F38

Type

1A

Rated Voltage

225

Capacitance Code

pF code: 1st two digits represent significant figures, 3rd digit represents multiplier (number of zeros to follow)

M

Tolerance
M = ±20%

M

Case Size
See table above



Packaging

Reel Dia (φ180)	Tape Width (mm)
A	8



Special Code

AXE = Rated temperature 60°C and H dimension 1.0mm Max.
 AXEH3 = Rated temperature 60°C and H dimension 1.0mm Max., Low ESR
 LZT = Rated temperature 60°C only
 AH1, AH2, AH3 = Low ESR

TECHNICAL SPECIFICATIONS

Category Temperature Range:	-55 to +105°C
Rated Temperature:	+85°C (*2)
Capacitance Tolerance:	±20% at 120Hz
Dissipation Factor:	Refer to next page (120Hz)
ESR 100kHz:	Refer to next page (120Hz)
Leakage Current:	Refer to next page At 20°C after application of rated voltage for 5 minutes Provided that: After 5 minute's application of rated voltage, leakage current at 105°C 10 times or less than 20°C specified value.

*2 F380J476MMAAXE: Rated temperature +60°C Surge, endurance test temperature +60°C

F38 Series



Conductive Polymer, Miniature, Undertab Solid Electrolytic Chip Capacitors

CAPACITANCE AND RATED VOLTAGE RANGE (LETTER DENOTES CASE SIZE)

Capacitance		Rated Voltage			*Cap Code
µF	Code	4V (0G)	6.3V (0J)	10V (1A)	
1.0	105		U		A
2.2	225			M	J
4.7	475		U	M	S
10	106		M/M(AH1,AH2)	M/M(AH1)	a
22	226		M/M(AH3,AH1)/S/S(AH1)	S	j
33	336		M**/S	S**	n
47	476		M*/M*(H3)/S/S(AH1)		s
68	686		S**		w
100	107	S**			A

Available Ratings, (Low ESR)

*4 Rated temperature 60°C and H dimension 1.0mm Max only. Please contact AVX when you need detail spec.

**Rated temperature 60°C only. Please contact AVX when you need detail spec.

Please contact to your local AVX sales office when these series are being designed in your application.

RATINGS & PART NUMBER REFERENCE

AVX Part No.	Case Size	Capacitance (µF)	Rated Voltage (V)	Leakage Current (µA)	DF @ 120Hz (%)	ESR @ 100kHz (mΩ)	100kHz RMS Current (mA)	*3 ΔC/C (%)
							45°C	
4 Volt								
F380G107MSALZT	S	100	4	80.0	10	200	474	*
6.3 Volt								
F380J105MUA	U	1	6.3	0.6	6	1500	100	*
F380J475MUA	U	4.7	6.3	20.0	10	1500	100	*
F380J106MMA	M	10	6.3	10.0	8	500	224	*
F380J106MMAAH1	M	10	6.3	10.0	8	300	289	*
F380J106MMAAH2	M	10	6.3	10.0	8	200	354	*
F380J226MMA	M	22	6.3	13.9	10	500	224	*
F380J226MMAAH3	M	22	6.3	13.9	10	300	289	*
F380J226MMAAH1	M	22	6.3	13.9	10	200	354	*
F380J226MSA	S	22	6.3	13.9	10	200	474	*
F380J226MSAAH1	S	22	6.3	13.9	10	150	548	*
F380J336MMALZT	M	33	6.3	41.6	10	500	224	*
F380J336MSA	S	33	6.3	20.8	10	200	474	*
F380J476MMAAXE ⁴	M	47	6.3	59.2	10	500	224	*
F380J476MMAAXEH3	M	47	6.3	59.2	10	300	289	*
F380J476MSA	S	47	6.3	29.6	10	200	474	*
F380J476MSAAH1	S	47	6.3	29.6	10	150	548	*
F380J686MSALZT	S	68	6.3	86.0	10	200	474	*
10 Volt								
F381A225MMA	M	2.2	10	10.0	6	500	224	*
F381A475MMA	M	4.7	10	10.0	6	500	224	*
F381A106MMA	M	10	10	10.0	15	500	224	*
F381A106MMAAH1	M	10	10	10.0	15	300	289	*
F381A226MSA	S	22	10	22.0	10	200	474	*
F381A336MSALZT	S	33	10	99.0	10	200	474	*

3: ΔC/C Marked ""

Item	All Case (%)
Damp Heat, steady state	-20 to +30
Rapid change of temperature	±20
Resistance soldering heat	±20
Surge	±20
Endurance	±20

THE CORRELATIONS AMONG RATED VOLTAGE, SURGE VOLTAGE AND DERATED VOLTAGE

	F38 (Standard)	
Rated Voltage (V) ≤85°C	6.3	10
85°C Surge Voltage (V)	8	13
105°C Derated Voltage (V)	5	8

	F38-LZT, F38-AXE		
Rated Voltage (V) ≤60°C	4	6.3	10
60°C Surge Voltage (V)	5.2	8	13
85°C Derated Voltage (V)	2.8	4.5	7.2
105°C Derated Voltage (V)	2	3.3	5

F38 Series



Conductive Polymer, Miniature, Undertab Solid Electrolytic Chip Capacitors

RECOMMENDED DERATING FACTOR

Voltage and temperature derating as percentage of Vr

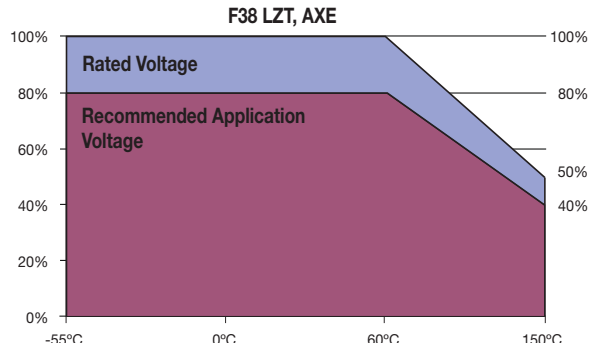
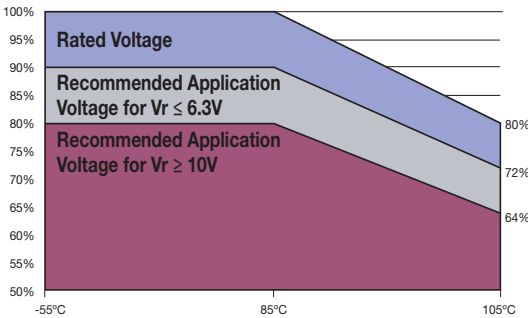

QUALIFICATION TABLE

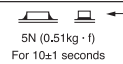
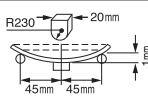
TEST	F38 series (Temperature range -55°C to +105°C)	
	Condition	
Damp Heat (Steady State)	At 40°C, 90 to 95% R.H., 500 hours (No voltage applied) Capacitance Change Refer to page 181 (*3) Dissipation Factor 200% or less of initial specified value Leakage Current 300% or less of Initial specified value	
Temperature Cycles	At -55°C / +105°C, 30 minutes each, 5 cycles Capacitance Change Refer to page 181 (*3) Dissipation Factor 200% or less of initial specified value Leakage Current 400% or less of initial specified value	
Resistance to Soldering Heat	5 seconds reflow at 260°C Capacitance Change Refer to page 181 (*3) Dissipation Factor 200% or less of initial specified value Leakage Current 300% or less of initial specified value	
Surge	After application of surge voltage in series with a 1kΩ resistor at the rate of 30 seconds ON, 30 seconds OFF, for 1000 successive test cycles at 85°C (*2), capacitors shall meet the characteristic requirements in the table above. Capacitance Change Refer to page 181 (*3) Dissipation Factor 200% or less of initial specified value Leakage Current 300% or less of initial specified value	
Endurance	After 1000 hours' application of rated voltage in series with a 3Ω resistor at 85°C (*2), capacitors shall meet the characteristic requirements in the table above. Capacitance Change Refer to page 181 (*3) Dissipation Factor 200% or less of initial specified value Leakage Current 400% or less of initial specified value	
Shear Test	After applying the pressure load of 5N for 10±1 seconds horizontally to the center of capacitor side body which has no electrode and has been soldered beforehand on a substrate, there shall be found neither exfoliation nor its sign at the terminal electrode. 	
Terminal Strength	Keeping a capacitor surface-mounted on a substrate upside down and supporting the substrate at both of the opposite bottom points 45mm apart from the center of capacitor, the pressure strength is applied with a specified jig at the center of substrate so that the substrate may bend by 1mm as illustrated. Then, there shall be found no remarkable abnormality on the capacitor terminals. 	

*2 F380J476MMAAXE: Rated temperature +60°C Surge, endurance test temperature +60°C

NOTICE: DESIGN, SPECIFICATIONS ARE SUBJECT TO CHANGE WITHOUT NOTICE.

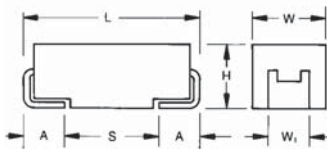

FEATURES

- Conductive polymer electrode
- Benign failure mode under recommended use conditions
- Robust design for automotive applications
- Meets requirements of AEC-Q200
- Humidity 85°C/85%RH, Vr, (up to 500 or 1000 hours see reference table)
- Basic reliability 1%/1000hrs@85°C Vr with 60% confidence level
- -55 to +125°C operation temperature
- Full voltage range: 4-50V
- DCL 0.1 CV
- 3x reflow 260°C compatible



APPLICATIONS

- Automotive, DC/DC converters, Telecommunications, Industrial
- Reference AVX polymer guide for more information.

MARKING

B, D, Y CASE

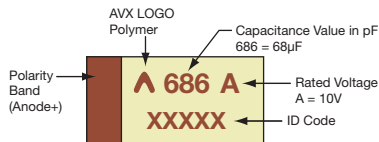

AVX's qualification of TCQ capacitors meets requirements of AEC-Q200. TCQ series is manufactured in an ISO TS 16949 certified facility.

CASE DIMENSIONS: millimeters (inches)

Code	EIA Code	EIA Metric	L±0.20 (0.008)	W±0.20 (0.008) -0.10 (0.004)	H±0.20 (0.008) -0.10 (0.004)	W ₁ ±0.20 (0.008)	A±0.30 (0.012) -0.20 (0.008)	S Min.
B	1210	3528-21	3.50 (0.138)	2.80 (0.110)	1.90 (0.075)	2.20 (0.087)	0.80 (0.031)	1.40 (0.055)
D	2917	7343-31	7.30 (0.287)	4.30 (0.169)	2.90 (0.114)	2.40 (0.094)	1.30 (0.051)	4.40 (0.173)
Y	2917	7343-20	7.30 (0.287)	4.30 (0.169)	2.00 (0.079) max	2.40 (0.094)	1.30 (0.051)	4.40 (0.173)

W1 dimension applies to the termination width for A dimensional area only.

HOW TO ORDER

TCQ

Type

B

Case Size
See table above

476

Capacitance Code
pF code: 1st two digits represent significant figures, 3rd digit represents multiplier (number of zeros to follow)

M

Tolerance
M = ±20%

006

Rated DC Voltage
004 = 4Vdc
006 = 6.3Vdc
010 = 10Vdc
016 = 16Vdc
020 = 20Vdc
025 = 25Vdc
035 = 35Vdc
050 = 50Vdc

#

Packaging
R = Pure Tin 7" Reel
S = Pure Tin 13" Reel

0070

ESR in mΩ

TECHNICAL SPECIFICATIONS

Technical Data:	All technical data relate to an ambient temperature of +25°C
Capacitance Range:	4.7 µF to 220 µF
Capacitance Tolerance:	±20%
Leakage Current DCL:	0.1CV
Temperature Range:	-55°C to +125°C
Reliability:	1% per 1000 hours at 85°C, V _R with 0.1Ω/V series impedance 60% confidence level Meets requirements of AEC-Q200 (for humidity 85°C/85%RH, V _R details see reference table)

NOTE: Conductive Polymer Capacitors are designed to operate within the limits of the environmental conditions specified for each series. If operated continuously at their maximum temperature and / or humidity limit, or beyond these limits, capacitors may exhibit a parametric shift in capacitance and increases in ESR. These changes may occur earlier if the specified environmental conditions are exceeded. Similarly, their normal operational time period will be significantly extended if their general duty cycle includes operation below maximum temperature within humidity controlled environments. Careful attention should be paid to maximum temperature with associated high humidity environments as well as voltage derating, ripple current and current surges. Please reference the AVX Conductive Polymer Capacitor Guidelines for more information or contact factory for application assistance.

Automotive Conductive Polymer Chip Capacitors

CAPACITANCE AND RATED VOLTAGE RANGE (LETTER DENOTES CASE SIZE)

Capacitance		Rated Voltage DC (V _R) @ 105°C							
µF	Code	4V (G)	6.3V (J)	10V (A)	16V (C)	20V (D)	25V (E)	35V (V)	50V (T)
3.3	335								
4.7	475							B(200)*	
6.8	685						B(200)*		
10	106					B(200)*		D(70)	D(90)
15	156						D(70)		
22	226		B(70)	B(70)*		D(70)			
33	336		B(70)	B(70)*	D(70)				
47	476		B(70)	B(70)*	D(70)				
68	686			D(25,40)					
100	107			D(25,40)					
150	157		D(25,40)						
220	227	D(25), Y(25)							

Released ratings, (ESR ratings in mOhms in parenthesis)

Engineering samples - please contact AVX

*Ratings under development - subject to change

Note: Voltage ratings are minimum values. AVX reserves the right to supply higher ratings in the same case size, to the same reliability standards.

RATINGS & PART NUMBER REFERENCE

AVX Part No.	Case Size	Capacitance (µF)	Rated Voltage (V)	Maximum Operating Temp. (°C)	DCL Max (µA)	DF Max (%)	ESR Max @ 100kHz (mΩ)	MSL	100kHz RMS Current (mA)				Humidity 85°C/85%RH, Vr (hrs)
									45°C	85°C	105°C	125°C	
4 Volt													
TCQD227M004#0025	D	220	4	125	88	6	25	3	3000	2100	1350	750	1000
TCQY227M004#0025	Y	220	4	125	88	6	25	3	2720	1904	1224	680	500
6.3 Volt													
TCQB226M006#0070	B	22	6.3	125	13.2	6	70	3	1336	935	601	334	500
TCQB336M006#0070	B	33	6.3	125	19.8	6	70	3	1336	935	601	334	500
TCQB476M006#0070	B	47	6.3	125	28.2	6	70	3	1336	935	601	334	500
TCQD157M006#0025	D	150	6.3	125	90	6	25	3	3000	2100	1350	750	1000
TCQD157M006#0040	D	150	6.3	125	90	6	40	3	2372	1660	1067	593	1000
10 Volt													
TCQD686M010#0025	D	68	10	125	68	6	25	3	3000	2100	1350	750	1000
TCQD686M010#0040	D	68	10	125	68	6	40	3	2372	1660	1067	593	1000
TCQD107M010#0025	D	100	10	125	100	6	25	3	3000	2100	1350	750	1000
TCQD107M010#0040	D	100	10	125	100	6	40	3	2372	1660	1067	593	1000
16 Volt													
TCQD336M016#0070	D	33	16	125	52.8	6	70	3	1793	1255	807	448	1000
TCQD476M016#0070	D	47	16	125	75.2	6	70	3	1793	1255	807	448	1000
20 Volt													
TCQD226M020#0070	D	22	20	125	44	6	70	3	1793	1255	807	448	1000
25 Volt													
TCQD156M025#0070	D	15	25	125	37.5	6	70	3	1793	1255	807	448	1000
35 Volt													
TCQD106M035#0070	D	10	35	125	35	6	70	3	1793	1255	807	448	1000
50 Volt													
TCQD106M050#0090	D	10	50	125	50	10	90	3	1581	1107	712	395	500

Moisture Sensitivity Level (MSL) is defined according to J-STD-020.

All technical data relates to an ambient temperature of +25°C. Capacitance and DF are measured at 120Hz, 0.5RMS with DC bias of 2.2 volts. DCL is measured at rated voltage after 5 minutes.

ESR allowed to move up to 1.25 times catalog limit post mounting.

For typical weight and composition see page 222.

NOTE: AVX reserves the right to supply a higher voltage rating or tighter tolerance part in the same case size, to the same reliability standards.

RECOMMENDED DERATING FACTOR

Voltage and temperature derating as percentage of V_r :

Rated voltage	Operating Temperature		
	≤85°C	105°C	125°C
≤10V	90%	90%	60%
≥16V	80%	80%	54%

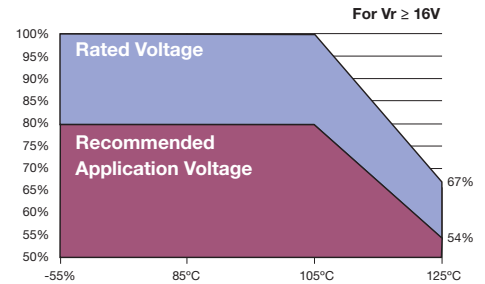
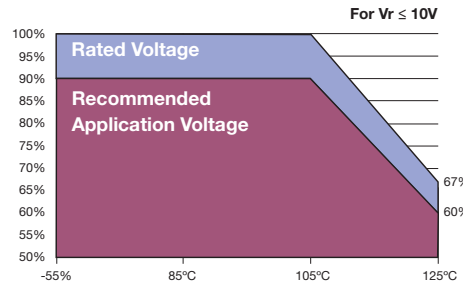

QUALIFICATION TABLE

TEST	TCQ series (Temperature range -55°C to 125°C)										
	Condition				Characteristics						
Endurance	Determine after application of 125°C temperature, 2/3 rated voltage for 1000 +48/-0 hours and then leaving 1-2 hours at room temperature. Power supply impedance to be ≤ 0.1Ω/V.				Visual examination	no visible damage					
					DCL	2 x initial limit					
					ΔC/C	within +10/-20% of initial value					
					DF	2 x initial limit					
					ESR	2 x initial limit					
Storage Life	125°C, 0V, 1000h				Visual examination	no visible damage					
					DCL	2x initial limit					
					ΔC/C	within +10/-20% of initial value					
					DF	2 x initial limit					
					ESR	2 x initial limit					
Biased Humidity	Determine after leaving for 1000 (500) hours at 85±2°C, 85% relative humidity and rated voltage and then recovery 1-2 hours at room temperature.				Visual examination	no visible damage					
					DCL	2 x initial limit					
					ΔC/C	within +35/-5% of initial value					
					DF	1.5 x initial limit					
					ESR	2 x initial limit					
Temperature Stability	Step	Temperature°C	Duration(min)		+20°C	-55°C	+20°C	+85°C	+125°C	+20°C	
	1	+20±2	15								
	2	-55+0/-3	15	DCL	IL*	n/a	IL*	10 x IL*	12.5 x IL*	IL*	
	3	+20±2	15	ΔC/C	n/a	±20%	±5%	±20%	±30%	±5%	
	4	+85+3/-0	15	DF	IL*	IL*	IL*	1.2 x IL*	1.5 x IL*	IL*	
	5	+125+3/-0	15								
6	+20±2	15									
Surge Voltage	Test temperature: 125°C +3/0°C Surge voltage: 1.3x 2/3x rated voltage at 125°C Charge/Discharge resistance: 1000±100Ω Number of cycles: 1000x Cycle duration: 6 min; 30 sec charge, 5 min 30 sec discharge				Visual examination	no visible damage					
					DCL	initial limit					
					ΔC/C	within +10/-20% of initial value for $V_r \leq 10V$ within +20/-30% of initial value for $V_r \geq 16V$					
					DF	initial limit for $V_r \leq 10V$ 1.25x initial limit for $V_r \geq 16V$					
					ESR	1.25 x initial limit					
Mechanical Shock	MIL-STD-202, Method 213, Condition F				Visual examination	no visible damage					
					DCL	initial limit					
					ΔC/C	within ±10% of initial value					
					DF	initial limit					
					ESR	1.25 x initial limit					
Vibration	MIL-STD-202, Method 204, Condition D				Visual examination	no visible damage					
					DCL	initial limit					
					ΔC/C	within ±10% of initial value					
					DF	initial limit					
					ESR	1.25 x initial limit					

*Initial Limit

For use outside of recommended conditions and special request, please contact manufacturer.

Initial measurement max. 1hr after the removal from dry pack or after pretreatment at 85°C for 24 hours.

TCR Series



Professional Conductive Polymer Chip Capacitors



FEATURES

- Conductive polymer electrode
- Benign failure mode under recommended use conditions
- Robust design for long operation lifetime
- AVX maverick part control Q-process with statistical screening
- Improved basic reliability 0.5%/1000hrs
- Humidity 85°C/85%RH, Vr, (up to 500 or 1000 hours see reference table)
- -55 to +125°C operation temperature
- DCL 0.1 CxV, 0.05CV on selected codes
- 3x reflow 260°C compatible
- Low ESR



SnPb termination option is not RoHS compliant.



APPLICATIONS

- Long life time DC/DC converter applications in Telecommunications, Industrial, Avionics

For additional information on Q-process please consult the AVX technical publication "Reaching the Highest Reliability for Tantalum Capacitors" (see the link: <http://www.avx.com/docs/techinfo/Qprocess.pdf>)

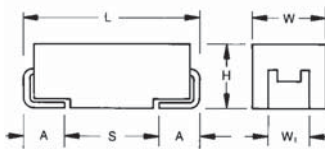

CASE DIMENSIONS: millimeters (inches)

Code	EIA Code	EIA Metric	L±0.20 (0.008)	W+0.20 (0.008) -0.10 (0.004)	H+0.20 (0.008) -0.10 (0.004)	W _i ±0.20 (0.008)	A+0.30 (0.012) -0.20 (0.008)	S Min.
B	1210	3528-21	3.50 (0.138)	2.80 (0.110)	1.90 (0.075)	2.20 (0.087)	0.80 (0.031)	1.40 (0.055)
D	2917	7343-31	7.30 (0.287)	4.30 (0.169)	2.90 (0.114)	2.40 (0.094)	1.30 (0.051)	4.40 (0.173)
T	1210	3528-12	3.50 (0.138)	2.80 (0.110)	1.20 (0.047) max.	2.20 (0.087)	0.80 (0.031)	1.40 (0.055)
Y	2917	7343-20	7.30 (0.287)	4.30 (0.169)	2.00 (0.079) max.	2.40 (0.094)	1.30 (0.051)	4.40 (0.173)

W1 dimension applies to the termination width for A dimensional area only.

*Codes under development

MARKING

B, D, T, Y CASE

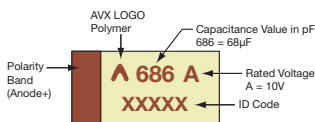

HOW TO ORDER

TCR

Type

D

Case Size

See table above

476

Capacitance Code

pF code: 1st two digits represent significant figures, 3rd digit represents multiplier (number of zeros to follow)

M

Tolerance

M = ±20%

016

Rated DC Voltage

004 = 4Vdc
006 = 6.3Vdc
010 = 10Vdc
016 = 16Vdc
020 = 20Vdc
025 = 25Vdc
035 = 35Vdc
050 = 50Vdc

#

Packaging

R = Pure Tin 7" Reel
S = Pure Tin 13" Reel
H = Tin Lead 7" Reel (contact manufacturer)
K = Tin Lead 13" Reel (contact manufacturer)

0070

ESR in mΩ

J

DCL

J = 0.1CV

TECHNICAL SPECIFICATIONS

Technical Data:	All technical data relate to an ambient temperature of +25°C
Capacitance Range:	10µF to 220µF
Capacitance Tolerance:	±20%
Leakage Current DCL:	(J) 0.1CV
Temperature Range:	-55°C to +125°C
Basic Reliability:	0.5% per 1000 hours at 85°C, Vr with 0.1ΩV series impedance, 60% confidence level
Termination Finish:	Sn Plating (standard) and SnPb Plating upon request

NOTE: Conductive Polymer Capacitors are designed to operate within the limits of the environmental conditions specified for each series. If operated continuously at their maximum temperature and / or humidity limit, or beyond these limits, capacitors may exhibit a parametric shift in capacitance and increases in ESR. These changes may occur earlier if the specified environmental conditions are exceeded. Similarly, their normal operational time period will be significantly extended if their general duty cycle includes operation below maximum temperature within humidity controlled environments. Careful attention should be paid to maximum temperature with associated high humidity environments as well as voltage derating, ripple current and current surges. Please reference the AVX Conductive Polymer Capacitor Guidelines for more information or contact factory for application assistance.



CAPACITANCE AND RATED VOLTAGE RANGE (LETTER DENOTES CASE SIZE)

Capacitance		Rated Voltage DC (V _r)							
μF	Code	4V (G)	6.3V (J)	10V (A)	16V (C)	20V (D)	25V (E)	35V (V)	50V (T)
10	106							D(70)	D(120)
15	156						D(70)		
22	226		B(70)			D(70)			
33	336		B(70)	T(70)*	D(70)				
47	476		B(70)		D(70)				
68	686			D(70)					
100	107			D(70)					
150	157		D(40)						
220	227	D(40), Y(40)							

Available Ratings, (ESR ratings in mOhms in brackets)

Engineering samples - please contact manufacturer

*Codes under development – subject to change

Note: Voltage ratings are minimum values. AVX reserves the right to supply higher ratings in the same case size, to the same reliability standards.

RATINGS & PART NUMBER REFERENCE

AVX Part No.	Case Size	Capacitance (μF)	Rated Voltage (V)	Maximum Operating Temperature (°C)	DCL Max. (μA)	DF Max. (%)	ESR Max @ 100kHz (mΩ)	MSL	100kHz RMS Current (mA)				Humidity 85°C/85%RH, Vr (hrs)	
									45°C	85°C	105°C	125°C		
4 Volt														
TCRD227M004#0040J	D	220	4	125	88	6	40	3	2400	1700	1100	600	1000	
TCRY227M004#0040J	Y	220	4	125	88	6	40	3	2200	1500	1000	600	500	
6.3 Volt														
TCRB226M006#0070J	B	22	6.3	125	13	6	70	3	1300	900	600	300	500	
TCRB336M006#0070J	B	33	6.3	125	19	6	70	3	1300	900	600	300	500	
TCRB476M006#0070J	B	47	6.3	125	28	6	70	3	1300	900	600	300	500	
TCRD157M006#0040J	D	150	6.3	125	90	6	40	3	2400	1700	1100	600	1000	
10 Volt														
TCRD686M010#0070J	D	68	10	125	68	6	70	3	1800	1300	800	500	1000	
TCRD107M010#0070J	D	100	10	125	100	6	70	3	1800	1300	800	500	1000	
16 Volt														
TCRD336M016#0070J	D	33	16	125	52	6	70	3	1800	1300	800	500	1000	
TCRD476M016#0070J	D	47	16	125	75	6	70	3	1800	1300	800	500	1000	
20 Volt														
TCRD226M020#0070J	D	22	20	125	44	8	70	3	1800	1300	800	500	1000	
25 Volt														
TCRD156M025#0070J	D	15	25	125	37	8	70	3	1800	1300	800	500	1000	
35 Volt														
TCRD106M035#0070J	D	10	35	125	35	8	70	3	1800	1300	800	500	1000	
50 Volt														
TCRD106M050#0120J	D	10	50	125	50	10	120	3	1400	1000	600	400	500	

Moisture Sensitivity Level (MSL) is defined according to J-STD-020.

All technical data relates to an ambient temperature of +25°C. Capacitance and DF are measured at 120Hz, 0.5RMS with DC bias of 2.2 volts. DCL is measured at rated voltage after 5 minutes.

ESR allowed to move up to 1.25 times catalog limit post mounting.

For typical weight and composition see page 222.

NOTE: AVX reserves the right to supply a higher voltage rating or tighter tolerance part in the same case size, to the same reliability standards.

RECOMMENDED DERATING FACTOR

Voltage and temperature derating as percentage of Vr.

Rated voltage	Operating Temperature		
	≤85°C	105°C	125°C
≤10V	90%	90%	60%
≥16V	80%	80%	54%

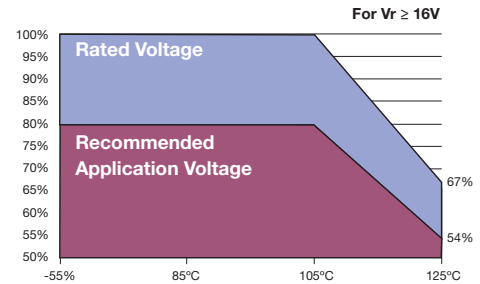
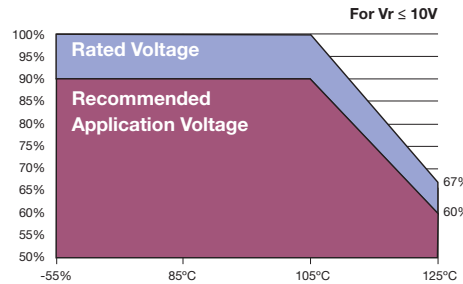

QUALIFICATION TABLE

TEST	TCR series (Temperature range -55°C to +125°C)									
	Condition			Characteristics						
Endurance	Determine after application of rated voltage for 2000 +48/-0 hours at 105±2°C. Also determine after application of 125°C temperature, 2/3 rated voltage for 2000 +48/-0 hours. After test leaving 1-2 hours at room temperature. Power supply impedance to be ≤0.1Ω/V.			Visual examination	no visible damage					
				DCL	2 x initial limit					
				ΔC/C	within +20/-30% of initial value					
				DF	2 x initial limit					
				ESR	2 x initial limit					
Storage Life	125°C, 0V, 2000h			Visual examination	no visible damage					
				DCL	2 x initial limit					
				ΔC/C	within ±20% of initial value					
				DF	2 x initial limit					
				ESR	2 x initial limit					
Biased Humidity	Determine after leaving for 500 or 1000 hours at 85±2°C, 85% relative humidity and rated voltage and then recovery 1-2 hours at room temperature.			Visual examination	no visible damage					
				DCL	3 x initial limit					
				ΔC/C	within +30/-20% of initial value					
				DF	1.5 x initial limit					
				ESR	2 x initial limit					
Temperature Stability	Step	Temperature°C	Duration(min)							
	1	+20±2	15	+20°C	-55°C	+20°C	+85°C	+125°C	+20°C	
	2	-55+0/-3	15	DCL	IL*	n/a	IL*	10 x IL*	12.5 x IL*	IL*
	3	+20±2	15		ΔC/C	n/a	±20%	±5%	±20%	±30%
	4	+85+3/-0	15	DF	IL*	1.5 x IL*	IL*	1.5 x IL*	2 x IL*	IL*
	5	+125+3/-0	15		ESR	1.25 x initial limit				
6	+20±2	15								
Surge Voltage	Test temperature: 125°C±3/0°C Surge voltage: 1.3 x 2/3 rated voltage Charge/Discharge resistance: 1000±100Ω Number of cycles: 1000x Cycle duration: 6 min; 30 sec charge, 5 min 30 sec discharge			Visual examination	no visible damage					
				DCL	initial limit					
				ΔC/C	within +20/-30% of initial value					
				DF	1.25 x initial limit					
				ESR	1.25 x initial limit					
Mechanical Shock/Vibration	MIL-STD-202, Method 213, Condition I, 100 G peak MIL-STD-202, Method 204, Condition D, 10 Hz to 2,000 Hz, 20 G peak			Visual examination	no visible damage					
				DCL	initial limit					
				ΔC/C	within ±10% of initial value					
				DF	initial limit					
				ESR	1.25 x initial limit					

*Initial Limit

For use outside of recommended conditions and special request, please contact manufacturer.
Initial measurement max. 1hr after the removal from dry pack or after pretreatment at 85°C for 24 hours.

TCH Low ESR Hermetic Series



SMD Low ESR Conductive Polymer Capacitors in Hermetic package

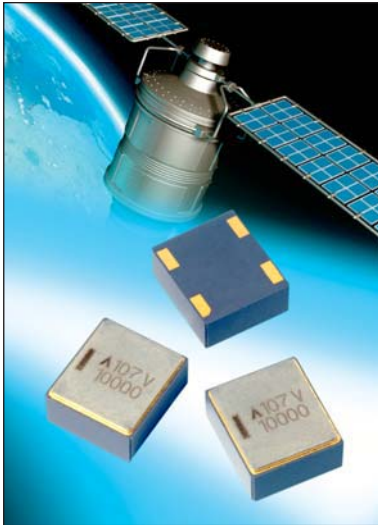

FEATURES

- Aerospace & Hi-Rel applications
- Low ESR conductive polymer electrode
- Endurance up to 10 000 hrs. on selected codes
- Ceramic case hermetic packaging
- Stability under humidity and ambient atmosphere exposure
- Large case sizes including CTC-21D provide high capacitance values
- Developed with ESA to suit aerospace applications
- Ongoing ESA qualification
- Manufacturing and screening utilizing AVX patented Q-Process to effectively remove components that may experience excessive parametric shifts or instability in operation life



Elektra Award 2015

APPLICATIONS

- Aerospace
- Defence
- Power supplies
- Pulse power

MARKING

9 CASE

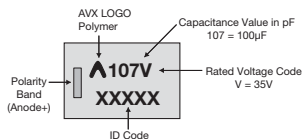

For additional information on Q-process please consult the AVX technical publication "Reaching the Highest Reliability for Tantalum Capacitors" (see the link: <http://www.avx.com/docs/techinfo/Qprocess.pdf>)

CASE DIMENSIONS: millimeters (inches)

Code	Type	L	W	H Max.	W ₁	A	S Min.
9 (CTC-21D)	J-lead (L-shape)	11.50 ± 0.50 (0.453 ± 0.020)	12.50 ± 0.50 (0.492 ± 0.020)	6.15 (0.242)	12.50 ± 0.50 (0.492 ± 0.020)	1.90 ± 0.50 (0.075 ± 0.020)	7.00 (0.276)
9 (CTC-21D)	Undertab	11.00 ± 0.20 (0.433 ± 0.008)	12.50 ± 0.20 (0.492 ± 0.008)	5.95 (0.234)	10.50 ± 0.20 (0.413 ± 0.008)	1.50 ± 0.20 (0.059 ± 0.008)	7.80 (0.307)

'J' Lead Termination (L-shape)

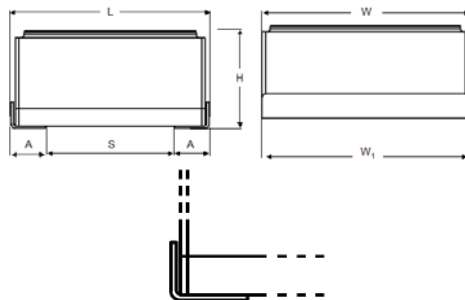

Undertab Termination

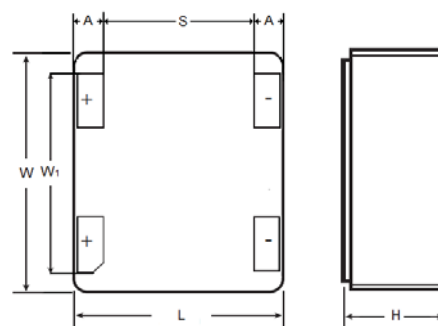

TECHNICAL SPECIFICATIONS

Technical Data:	All technical data relate to an ambient temperature of +25°C										
Capacitance Range:	22 µF to 330 µF (for extended range under development, contact manufacturer)										
Capacitance Tolerance:	±20%										
Leakage Current DCL:	0.1CV										
Rated Voltage (V _R)	≅ +85°C:	10	16	20	25	35	50	63	75	100	
Category Voltage (V _C)	≅ +125°C:	7	11	13	17	23	33	42	50	66	
Temperature Range:	-55°C to +125°C										
Reliability:	1% per 1000 hours at 85°C, V _r with 0.1Ω/V series impedance, 60% confidence level										
Termination Finish:	Gold Plating (Undertab), Gold Plating (J-lead), Sn/Pb Plating (J-lead)										

TCH Low ESR Hermetic Series



SMD Low ESR Conductive Polymer Capacitors in Hermetic package

HOW TO ORDER

AVX PART NUMBER

TCH	9	687	M	016	W	0040	U
Type	Case Size See table above	Capacitance Code pF code: 1st two digits represent significant figures 3rd digit represents multiplier (number of zeros to follow)	Tolerance M = ±20%	Rated DC Voltage 010 = 10Vdc 050 = 50Vdc 016 = 16Vdc 063 = 63Vdc 020 = 20Vdc 075 = 75Vdc 025 = 25Vdc 100 = 100Vdc 035 = 35Vdc	Packaging W = Waffle B = Bulk	ESR in mΩ	Termination J = 'J' lead L-shape (Gold) L = 'J' lead L-shape (Sn/Pb) U = Undertab



CAPACITANCE AND VOLTAGE RANGE (CASE CODE BEFORE THE BRACKETS)

Capacitance		Rated Voltage DC (V _R) at 85°C								
μF	Code	10V	16V	20V	25V	35V	50V	63V	75V	100V
15	156									9(150)*
22	226								9(120)*	9(150)
33	336							9(100)*	9(120)	
47	476						9(70)	9(100)*		
68	686						9(70)*			
100	107				9(50)*	9(55)				
150	157			9(45)*	9(50)	9(55)				
220	227	9(40)*	9(40)	9(45)*	9(50)*					
330	337	9(40)	9(40)*	9(45)*						
470	477	9(40)*	9(40)*							
680	687	9(40)*	9(40)*							

Available Ratings, (ESR ratings in mOhms in brackets)

Engineering samples - please contact manufacturer

*Codes under development – upon request, please contact manufacturer

TCH Low ESR Hermetic Series



SMD Low ESR Conductive Polymer Capacitors in Hermetic package

RATINGS & PART NUMBER REFERENCE

AVX Part No.	Case Size	Capacitance (μF)	Rated Voltage (V)	Rated Temperature (°C)	Category Voltage (V)	Category Temperature (°C)	DCL Max. (μA)	DF Max. (%)	ESR Max. @ 100kHz (mΩ)	MSL	100kHz RMS Current (A)		
											25°C	85°C	125°C
10 Volt @ 85°C													
TCH9337M010W0040#	9	330	10	85	7	125	330	8	40	1	3.16	2.84	1.26
16 Volt @ 85°C													
TCH9227M016W0040#	9	220	16	85	10	125	352	8	40	1	3.16	2.84	1.26
25 Volt @ 85°C													
TCH9157M025W0050#	9	150	25	85	17	125	375	8	50	1	2.83	2.55	1.13
35 Volt @ 85°C													
TCH9107M035W0055#	9	100	35	85	23	125	350	8	55	1	2.69	2.42	1.08
TCH9157M035W0055#	9	150	35	85	23	125	525	8	55	1	2.69	2.42	1.08
50 Volt @ 85°C													
TCH9476M050W0070#	9	47	50	85	33	125	235	8	70	1	2.39	2.15	0.96
75 Volt @ 85°C													
TCH9336M075W0120#	9	33	75	85	50	125	248	8	120	1	1.82	1.64	0.73
100 Volt @ 85°C													
TCH9226M100W0150#	9	22	100	85	66	125	220	8	150	1	1.63	1.47	0.65

All technical data relates to an ambient temperature of +25°C. Capacitance and DF are measured at 120Hz, 0.5RMS with a maximum DC bias of 2.2V. DCL is measured at rated voltage after 5 minutes.

Moisture Sensitivity Level (MSL) is defined according to J-STD-020.

RECOMMENDED DERATING FACTOR

Voltage and temperature derating as percentage of Vr

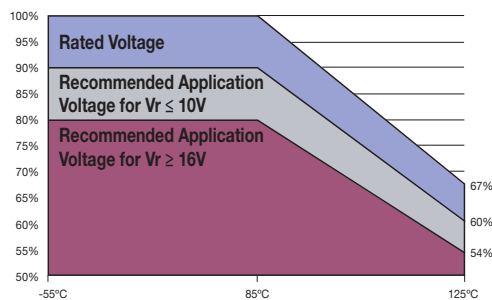

TCH Low ESR Hermetic Series



SMD Low ESR Conductive Polymer Capacitors in Hermetic package

QUALIFICATION TABLE

TEST	TCH low ESR hermetic series (Temperature range -55°C to +125°C)									
	Condition			Characteristics						
Endurance	Determine after application of rated voltage for 2000 (10000) +48/0 hours at 85±2°C and then leaving min. 2 hours at room temperature. Also determine of 125°C temperature, category voltage for 2000 +48/-0 hours and then leaving min. 2 hours at room temperature. Power supply impedance to be < 3Ω.			Visual examination	no visible damage					
				DCL	1.25 x initial limit					
				ΔC/C	within ±20% of initial value					
				DF	1.5 x initial limit					
				ESR	2 x initial limit					
Storage Life	125°C, 0V, 2000h			Visual examination	no visible damage					
				DCL	2 x initial limit					
				ΔC/C	within ±20% of initial value					
				DF	1.5 x initial limit					
				ESR	2 x initial limit					
Humidity	Determine after storage without applied voltage at 40±2°C and 90±2% relative humidity for 56 days and then recovery min. 2 hours at room temperature.			Visual examination	no visible damage					
				DCL	1.25 x initial limit					
				ΔC/C	within ±10% of initial value					
				DF	initial limit					
				ESR	1.25 x initial limit					
Temperature Stability	Step	Temperature°C	Duration (min)							
	1	+20	15							
	2	-55	15	DCL	IL*	n/a	IL*	10 x IL*	12.5 x IL*	IL*
	3	+20	15	ΔC/C	n/a	+0/-20%	±5%	+20/-0%	+30/-0%	±5%
	4	+85	15	DF	IL*	1.5 x IL*	IL*	1.5 x IL*	2 x IL*	IL*
	5	+125	15	ESR	1.25 x IL*	1.25 x IL*	1.25 x IL*	1.5 x IL*	1.5 x IL*	1.25 x IL*
	6	+20	15							
Surge Voltage	Test temperature: 85°C+3/0°C Surge voltage: 1.3 x rated voltage (for Ur ≤ 50V), 1.15 x rated voltage (for Ur > 50V) Series protection resistance: 33Ω (for Ur ≤ 50V), 1000Ω (for Ur > 50V) Discharge resistance: 33Ω Number of cycles: 1000x Cycle duration: 6 min; 30 sec charge, 5 min 30 sec discharge			Visual examination	no visible damage					
				DCL	initial limit					
				ΔC/C	within ±20% of initial value					
				DF	initial limit					
				ESR	1.25 x initial limit					
Mechanical Shock/Vibration	MIL-STD-202, Method 213, Condition C, 100 G peak MIL-STD-202, Method 204, Condition D, 10 Hz to 2,000 Hz, 20 G peak			Visual examination	no visible damage					
				DCL	initial limit					
				ΔC/C	within ±10% of initial value					
				DF	initial limit					
				ESR	1.25 x initial limit					

*Initial Limit

Section 3: Introduction



Foreword

AVX offers a broad line of solid Tantalum capacitors in a wide range of sizes, styles, and ratings to meet any design needs. This catalog combines into one source AVX's leaded tantalum capacitor information from its worldwide tantalum operations.

The TAP/TEP is rated for use from -55°C to +85°C at rated voltage and up to +125°C with voltage derating. There are three preferred wire forms to choose from which are available on tape and reel, and in bulk for hand insertion.

AVX has a complete tantalum applications service available for use by all our customers. With the capability to prototype and mass produce solid tantalum capacitors in special configurations, almost any design need can be fulfilled.

And if the customer requirements are outside our standard testing, AVX will work with you to define and implement a test or screening plan.

AVX is determined to become the world leader in tantalum capacitor technology and has made, and is continuing to make, significant investments in equipment and research to reach that end. We believe that the investment has paid off with the devices shown on the following pages.

Dipped Radial Capacitors

SOLID TANTALUM RESIN DIPPED SERIES TAP/TEP

The TAP/TEP resin dipped series of miniature tantalum capacitors is available for individual needs in both commercial and professional applications. From computers to automotive to industrial, AVX has a dipped radial for almost any application.

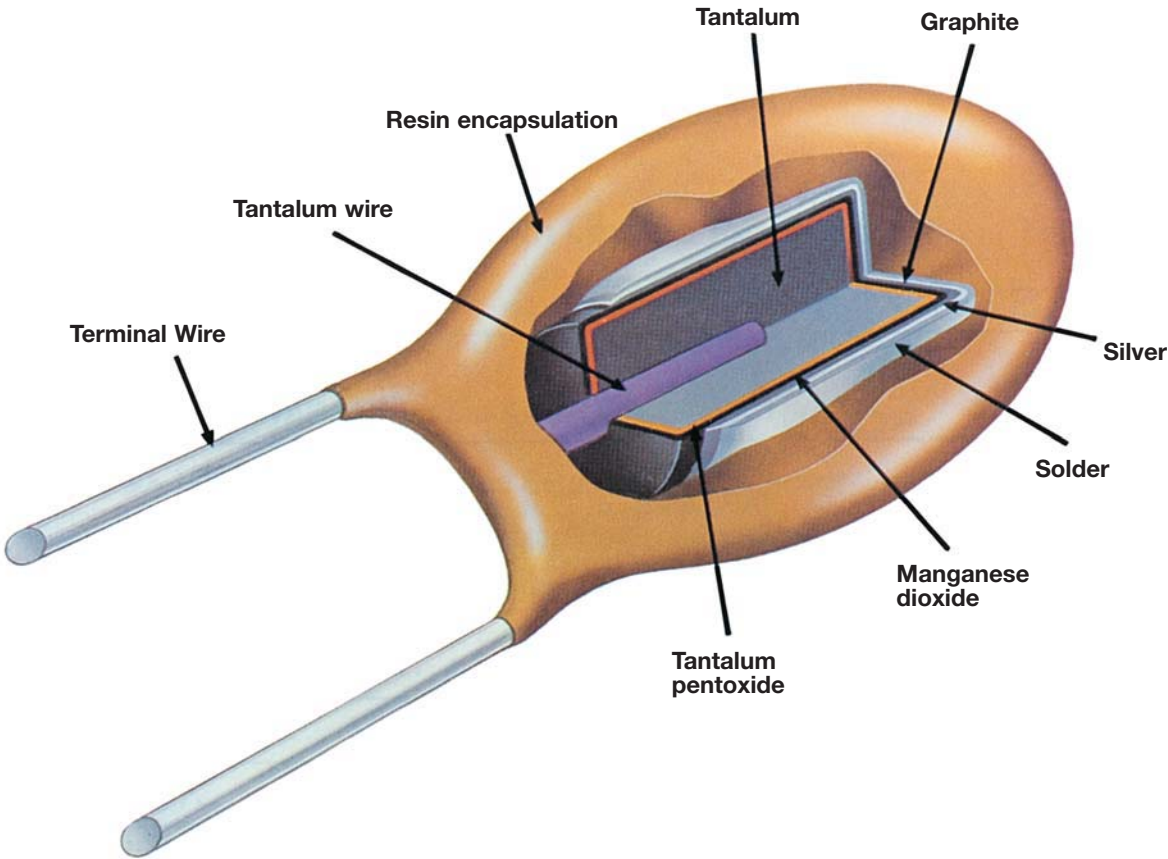

Dipped Radial Capacitors



Wire Form Outline

SOLID TANTALUM RESIN DIPPED TAP/TEP

Preferred Wire Forms

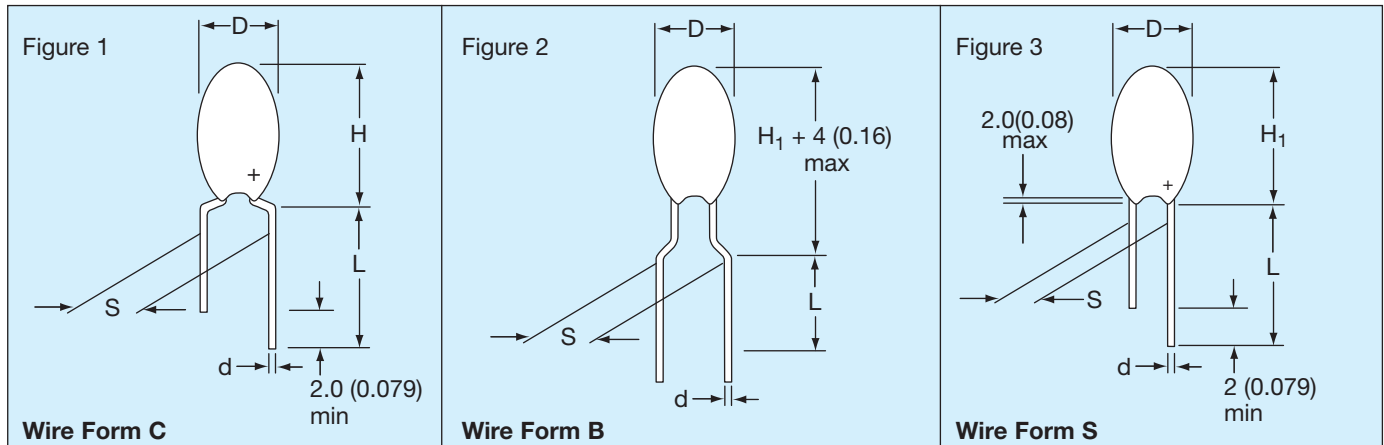

Non-Preferred Wire Forms (Not recommended for new designs)

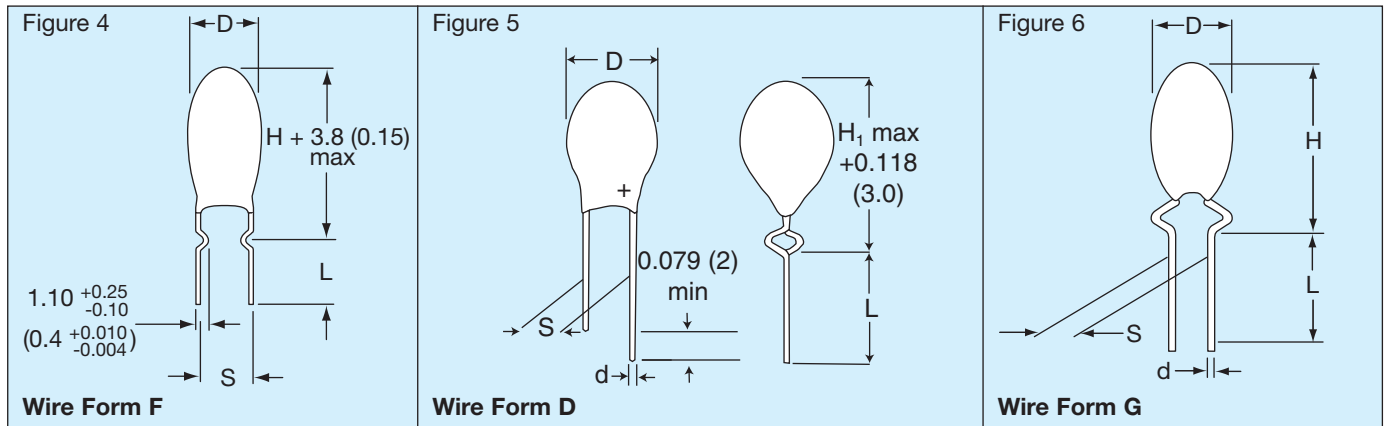

DIMENSIONS

millimeters (inches)

Wire Form	Figure	Case Size	L (see note 1)	S	d	Packaging Suffixes Available*
-----------	--------	-----------	----------------	---	---	-------------------------------

Preferred Wire Forms

C	Figure 1	A - R*	16.0±4.00 (0.630±0.160)	5.00±1.00 (0.200±0.040)	0.50±0.05 (0.020±0.002)	CCS Bulk CRW Tape/Reel CRS Tape/Ammo
B	Figure 2	A - J*	16.0±4.00 (0.630±0.160)	5.00±1.00 (0.200±0.040)	0.50±0.05 (0.020±0.002)	BRW Tape/Reel BRS Tape/Ammo
S	Figure 3	A - J*	16.0±4.00 (0.630±0.160)	2.50±0.50 (0.100±0.020)	0.50±0.05 (0.020±0.002)	SCS Bulk SRW Tape/Reel SRS Tape/Ammo

Non-Preferred Wire Forms (Not recommended for new designs)

F	Figure 4	A - R	3.90±0.75 (0.155±0.030)	5.00±0.50 (0.200±0.020)	0.50±0.05 (0.020±0.002)	FCS Bulk
D	Figure 5	A - H*	16.0±4.00 (0.630±0.160)	2.50±0.75 (0.100±0.020)	0.50±0.05 (0.020±0.002)	DCS Bulk DTW Tape/Reel DTS Tape/Ammo
G	Figure 6	A - J	16.0±4.00 (0.630±0.160)	3.18±0.50 (0.125±0.020)	0.50±0.05 (0.020±0.002)	GSB Bulk
H	Similar to Figure 1	A - R	16.0±4.00 (0.630±0.160)	6.35±1.00 (0.250±0.040)	0.50±0.05 (0.020±0.002)	HSB Bulk

Notes: (1) Lead lengths can be supplied to tolerances other than those above and should be specified in the ordering information.

(2) For D, H, and H₁ dimensions, refer to individual product on following pages.

* For case size availability in tape and reel, please refer to pages 201-202.

Dipped Radial Capacitors

TAP Series



SOLID TANTALUM RESIN DIPPED CAPACITORS

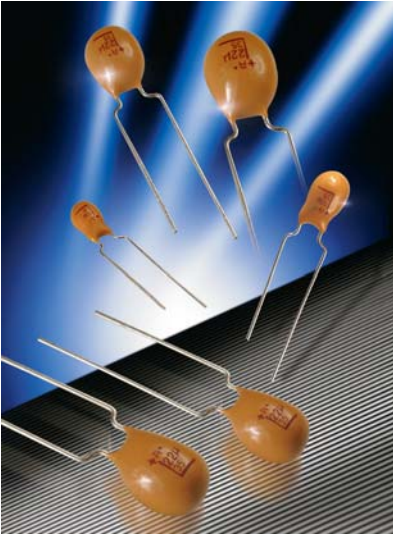

TAP is a professional grade device manufactured with a flame retardant coating and featuring low leakage current and impedance, very small physical sizes and exceptional temperature stability. It is designed and conditioned to operate to +125°C (see page 230 for voltage derating above 85°C) and is available loose or taped and reeled for auto insertion. The 15 case sizes with wide capacitance and working voltage ranges means the TAP can accommodate almost any application.



MAXIMUM CASE DIMENSIONS: millimeters (inches)

Wire Case	C, F, G, H H	B, S, D *H ₁	D
A	8.50 (0.330)	7.00 (0.280)	4.50 (0.180)
B	9.00 (0.350)	7.50 (0.300)	4.50 (0.180)
C	10.0 (0.390)	8.50 (0.330)	5.00 (0.200)
D	10.5 (0.410)	9.00 (0.350)	5.00 (0.200)
E	10.5 (0.410)	9.00 (0.350)	5.50 (0.220)
F	11.5 (0.450)	10.0 (0.390)	6.00 (0.240)
G	11.5 (0.450)	10.0 (0.390)	6.50 (0.260)
H	12.0 (0.470)	10.5 (0.410)	7.00 (0.280)
J	13.0 (0.510)	11.5 (0.450)	8.00 (0.310)
K	14.0 (0.550)	12.5 (0.490)	8.50 (0.330)
L	14.0 (0.550)	12.5 (0.490)	9.00 (0.350)
M	14.5 (0.570)	13.0 (0.510)	9.00 (0.350)
N	16.0 (0.630)		9.00 (0.350)
P	17.0 (0.670)		10.0 (0.390)
R	18.5 (0.730)		10.0 (0.390)

HOW TO ORDER

TAP	475	M	035	SCS
Type	Capacitance Code pF code: 1st two digits represent significant figures, 3rd digit represents multiplier (number of zeros to follow)	Capacitance Tolerance K = ±10% M = ±20% (For J = ±5% tolerance, please consult factory)	Rated DC Voltage	Suffix indicating wire form and packaging (see page 194)



Dipped Radial Capacitors



TAP Series

TECHNICAL SPECIFICATIONS

Technical Data:	All technical data relate to an ambient temperature of +25°C							
Capacitance Range:	0.10 μ F to 330 μ F							
Capacitance Tolerance:	\pm 20%; \pm 10% (\pm 5% consult your AVX representative for details)							
Rated Voltage DC (V_R)	$\leq +85^\circ\text{C}$:	6.3	10	16	20	25	35	50
Category Voltage (V_C)	$\leq +125^\circ\text{C}$:	4	6.3	10	13	16	23	33
Surge Voltage (V_S)	$\leq +85^\circ\text{C}$:	8	13	20	26	33	46	65
Surge Voltage (V_S)	$\leq +125^\circ\text{C}$:	5	9	12	16	21	28	40
Temperature Range:	-55°C to +125°C							
Environmental Classification:	55/125/56 (IEC 68-2)							
Dissipation Factor:	\leq 0.04 for C_R 0.1-1.5 μ F							
	\leq 0.06 for C_R 2.2-6.8 μ F							
	\leq 0.08 for C_R 10-68 μ F							
	\leq 0.10 for C_R 100-330 μ F							
Reliability:	1% per 1000 hrs. at 85°C with 0.1 Ω /V series impedance, 60% confidence level.							
Qualification:	CECC 30201 - 032							

CAPACITANCE AND RATED VOLTAGE RANGE (LETTER DENOTES CASE SIZE)

Capacitance		Rated voltage DC (V_R)						
μ F	Code	6.3V	10V	16V	20V	25V	35V	50V
0.10	104						A	A
0.15	154						A	A
0.22	224						A	A
0.33	334						A	A
0.47	474						A	A
0.68	684						A	B
1.0	105				A	A	A	C
1.5	155			A	A	A	A	D
2.2	225		A	A	A	A	B	E
3.3	335	A	A	A	B	B	C	F
4.7	475	A	A	B	C	C	E	G
6.8	685	A	B	C	D	D	F	H
10	106	B	C	D	E	E	F	J
15	156	C	D	E	F	F	H	K
22	226	D	E	F	H	H	K	L
33	336	E	F	F	J	J	M	
47	476	F	G	J	K	M	N	
68	686	G	H	L	N	N		
100	107	H	K	N	N			
150	157	K	N	N				
220	227	M	P	R				
330	337	P	R					

Values outside this standard range may be available on request.
AVX reserves the right to supply capacitors to a higher voltage rating, in the same case size, than that ordered.

MARKING

Polarity, capacitance, rated DC voltage, and an "A" (AVX logo) are laser marked on the capacitor body which is made of flame retardant gold epoxy resin with a limiting oxygen index in excess of 30 (ASTM-D-2863).

- Polarity
- Capacitance
- Voltage
- AVX logo
- Tolerance code:
 - \pm 20% = Standard (no marking)
 - \pm 10% = "K" on reverse side of unit
 - \pm 5% = "J" on reverse side of unit

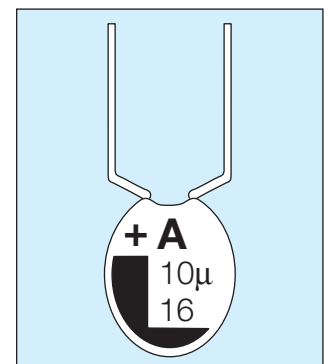

Dipped Radial Capacitors



TAP Series

RATINGS AND PART NUMBER REFERENCE

AVX Part No.	Case Size	Capacitance μ F	DCL (μ A) Max.	DF % Max.	ESR Max. (Ω) @ 100 kHz
6.3 volt @ 85°C (4 volt @ 125°C)					
TAP 335(+006	A	3.3	0.5	6	13.0
TAP 475(+006	A	4.7	0.5	6	10.0
TAP 685(+006	A	6.8	0.5	6	8.0
TAP 106(+006	B	10	0.5	8	6.0
TAP 156(+006	C	15	0.8	8	5.0
TAP 226(+006	D	22	1.1	8	3.7
TAP 336(+006	E	33	1.7	8	3.0
TAP 476(+006	F	47	2.4	8	2.0
TAP 686(+006	G	68	3.4	8	1.8
TAP 107(+006	H	100	5.0	10	1.6
TAP 157(+006	K	150	7.6	10	0.9
TAP 227(+006	M	220	11.0	10	0.9
TAP 337(+006	P	330	16.6	10	0.7
10 volt @ 85°C (6.3 volt @ 125°C)					
TAP 225(+010	A	2.2	0.5	6	13.0
TAP 335(+010	A	3.3	0.5	6	10.0
TAP 475(+010	A	4.7	0.5	6	8.0
TAP 685(+010	B	6.8	0.5	6	6.0
TAP 106(+010	C	10	0.8	8	5.0
TAP 156(+010	D	15	1.2	8	3.7
TAP 226(+010	E	22	1.7	8	2.7
TAP 336(+010	F	33	2.6	8	2.1
TAP 476(+010	G	47	3.7	8	1.7
TAP 686(+010	H	68	5.4	8	1.3
TAP 107(+010	K	100	8.0	10	1.0
TAP 157(+010	N	150	12.0	10	0.8
TAP 227(+010	P	220	17.6	10	0.6
TAP 337(+010	R	330	20.0	10	0.5
16 volt @ 85°C (10 volt @ 125°C)					
TAP 155(+016	A	1.5	0.5	4	10.0
TAP 225(+016	A	2.2	0.5	6	8.0
TAP 335(+016	A	3.3	0.5	6	6.0
TAP 475(+016	B	4.7	0.6	6	5.0
TAP 685(+016	C	6.8	0.8	6	4.0
TAP 106(+016	D	10	1.2	8	3.2
TAP 156(+016	E	15	1.9	8	2.5
TAP 226(+016	F	22	2.8	8	2.0
TAP 336(+016	F	33	4.2	8	1.6
TAP 476(+016	J	47	6.0	8	1.3
TAP 686(+016	L	68	8.7	8	1.0
TAP 107(+016	N	100	12.8	10	0.8
TAP 157(+016	N	150	19.2	10	0.6
TAP 227(+016	R	220	20.0	10	0.5
20 volt @ 85°C (13 volt @ 125°C)					
TAP 105(+020	A	1.0	0.5	4	10.0
TAP 155(+020	A	1.5	0.5	4	9.0
TAP 225(+020	A	2.2	0.5	6	7.0
TAP 335(+020	B	3.3	0.5	6	5.5
TAP 475(+020	C	4.7	0.7	6	4.5
TAP 685(+020	D	6.8	1.0	6	3.6
TAP 106(+020	E	10	1.6	8	2.9
TAP 156(+020	F	15	2.4	8	2.3
TAP 226(+020	H	22	3.5	8	1.8
TAP 336(+020	J	33	5.2	8	1.4
TAP 476(+020	K	47	7.5	8	1.2
TAP 686(+020	N	68	10.8	8	0.9
TAP 107(+020	N	100	16.0	10	0.6

AVX Part No.	Case Size	Capacitance μ F	DCL (μ A) Max.	DF % Max.	ESR Max. (Ω) @ 100 kHz
25 volt @ 85°C (16 volt @ 125°C)					
TAP 105(+025	A	1.0	0.5	4	10.0
TAP 155(+025	A	1.5	0.5	4	8.0
TAP 225(+025	A	2.2	0.5	6	6.0
TAP 335(+025	B	3.3	0.6	6	5.0
TAP 475(+025	C	4.7	0.9	6	4.0
TAP 685(+025	D	6.8	1.3	6	3.1
TAP 106(+025	E	10	2.0	8	2.5
TAP 156(+025	F	15	3.0	8	2.0
TAP 226(+025	H	22	4.4	8	1.5
TAP 336(+025	J	33	6.6	8	1.2
TAP 476(+025	M	47	9.4	8	1.0
TAP 686(+025	N	68	13.6	8	0.8
35 volt @ 85°C (23 volt @ 125°C)					
TAP 104(+035	A	0.1	0.5	4	26.0
TAP 154(+035	A	0.15	0.5	4	21.0
TAP 224(+035	A	0.22	0.5	4	17.0
TAP 334(+035	A	0.33	0.5	4	15.0
TAP 474(+035	A	0.47	0.5	4	13.0
TAP 684(+035	A	0.68	0.5	4	10.0
TAP 105(+035	A	1.0	0.5	4	8.0
TAP 155(+035	A	1.5	0.5	4	6.0
TAP 225(+035	B	2.2	0.6	6	5.0
TAP 335(+035	C	3.3	0.9	6	4.0
TAP 475(+035	E	4.7	1.3	6	3.0
TAP 685(+035	F	6.8	1.9	6	2.5
TAP 106(+035	F	10	2.8	8	2.0
TAP 156(+035	H	15	4.2	8	1.6
TAP 226(+035	K	22	6.1	8	1.3
TAP 336(+035	M	33	9.2	8	1.0
TAP 476(+035	N	47	10.0	8	0.8
50 volt @ 85°C (33 volt @ 125°C)					
TAP 104(+050	A	0.1	0.5	4	26.0
TAP 154(+050	A	0.15	0.5	4	21.0
TAP 224(+050	A	0.22	0.5	4	17.0
TAP 334(+050	A	0.33	0.5	4	15.0
TAP 474(+050	A	0.47	0.5	4	13.0
TAP 684(+050	B	0.68	0.5	4	10.0
TAP 105(+050	C	1.0	0.5	4	8.0
TAP 155(+050	D	1.5	0.6	4	6.0
TAP 225(+050	E	2.2	0.8	6	3.5
TAP 335(+050	F	3.3	1.3	6	3.0
TAP 475(+050	G	4.7	1.8	6	2.5
TAP 685(+050	H	6.8	2.7	6	2.0
TAP 106(+050	J	10	4.0	8	1.6
TAP 156(+050	K	15	6.0	8	1.2
TAP 226(+050	L	22	8.8	8	1.0

(*) Insert capacitance tolerance code; M for $\pm 20\%$, K for $\pm 10\%$ and J for $\pm 5\%$

NOTE: Voltage ratings are minimum values. AVX reserves the right to supply higher voltage ratings in the same case size.

Dipped Radial Capacitors



TEP Series Tin-Lead (Sn/Pb) Finish Product



TEP is a Tin-Lead finish version of the conformally coated tantalum radial leaded capacitor (TAP). It is a professional grade device manufactured with a flame retardant coating and featuring low leakage current and impedance, very small physical sizes and exceptional temperature stability, available in bulk and T&R packaging for auto insertion. The wide range of Capacitance, working voltages and case sizes enables TEP to accommodate to almost any application.

Not RoHS Compliant

CASE DIMENSIONS: millimeters (inches)

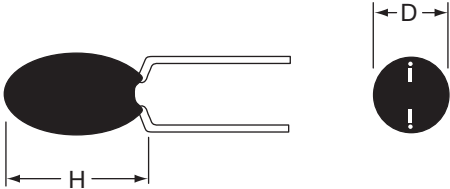

Wire Case	C, F, G, H H	B, S, D *H ₁	D
A	8.50 (0.335)	7.00 (0.276)	4.50 (0.177)
B	9.00 (0.354)	7.50 (0.295)	4.50 (0.177)
C	10.0 (0.394)	8.50 (0.335)	5.00 (0.197)
D	10.5 (0.413)	9.00 (0.354)	5.00 (0.197)
E	10.5 (0.413)	9.00 (0.354)	5.50 (0.217)
F	11.5 (0.453)	10.0 (0.394)	6.00 (0.236)
G	11.5 (0.453)	10.0 (0.394)	6.50 (0.256)
H	12.0 (0.472)	10.5 (0.413)	7.00 (0.276)
J	13.0 (0.512)	11.5 (0.453)	8.00 (0.315)
K	14.0 (0.551)		8.50 (0.335)
L	14.0 (0.551)		9.00 (0.354)
M	14.5 (0.571)		9.00 (0.354)
N	16.0 (0.630)		9.00 (0.354)
P	17.0 (0.669)		10.0 (0.394)
R	18.5 (0.728)		10.0 (0.394)

HOW TO ORDER

TEP

Type

106

Capacitance Code
pF code: 1st two digits represent significant figures, 3rd digit represents multiplier (number of zeros to follow)

M

Capacitance Tolerance
K = ±10%
M = ±20%
(For J = ±5% tolerance, please consult factory)

016

Rated DC Voltage

SCS

Suffix indicating wire form and packaging
(see page 194)

Dipped Radial Capacitors



TEP Series

TECHNICAL SPECIFICATIONS

Technical Data:	All technical data relate to an ambient temperature of +25°C							
Capacitance Range:	0.10 μ F to 330 μ F							
Capacitance Tolerance:	\pm 10%; \pm 20% (\pm 5% consult your AVX representative for details)							
Rated Voltage DC (V_R)	\leq +85°C:	6.3	10	16	20	25	35	50
Category Voltage (V_C)	\leq +125°C:	4	6.3	10	13	16	23	33
Surge Voltage (V_S)	\leq +85°C:	8	13	20	26	33	46	65
Surge Voltage (V_S)	\leq +125°C:	5	9	12	16	21	28	40
Temperature Range:	-55°C to +125°C							
Dissipation Factor:	\leq 0.04 for C_R 0.1-1.5 μ F							
	\leq 0.06 for C_R 2.2-6.8 μ F							
	\leq 0.08 for C_R 10-68 μ F							
	\leq 0.10 for C_R 100-330 μ F							
Reliability:	1% per 1000 hrs. at 85°C, V_R with 0.1 Ω /V series impedance, 60% confidence level.							

CAPACITANCE AND RATED VOLTAGE RANGE (LETTER DENOTES CASE SIZE)

Capacitance		Rated voltage DC (V_R)						
μ F	Code	6.3V	10V	16V	20V	25V	35V	50V
0.10	104						A	A
0.15	154						A	A
0.22	224						A	A
0.33	334						A	A
0.47	474						A	A
0.68	684						A	B
1.0	105				A	A	A	C
1.5	155			A	A	A	A	D
2.2	225		A	A	A	A	B	E
3.3	335	A	A	A	B	B	C	F
4.7	475	A	A	B	C	C	E	G
6.8	685	A	B	C	D	D	F	H
10	106	B	C	D	E	E	F	J
15	156	C	D	E	F	F	H	K
22	226	D	E	F	H	H	K	L
33	336	E	F	F	J	J	M	
47	476	F	G	J	K	M	N	
68	686	G	H	L	N	N		
100	107	H	K	N	N			
150	157	K	N	N				
220	227	M	P	R				
330	337	P	R					

Values outside this standard range may be available on request.

AVX reserves the right to supply capacitors to a higher voltage rating, in the same case size, than that ordered.

MARKING

Polarity, capacitance, rated DC voltage, and an "A" (AVX logo) are laser marked on the capacitor body which is made of flame retardant gold epoxy resin with a limiting oxygen index in excess of 30 (ASTM-D-2863).

- Polarity
- Capacitance
- Voltage
- AVX logo
- Tolerance code:
 - \pm 20% = Standard (no marking)
 - \pm 10% = "K" on reverse side of unit
 - \pm 5% = "J" on reverse side of unit

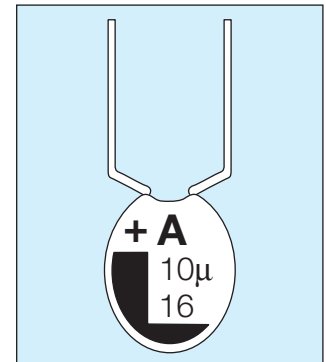

Dipped Radial Capacitors



TEP Series

RATINGS & PART NUMBER REFERENCE

AVX Part No.	Case Size	Cap (µF)	DCL (µA) Max.	DF % Max.	ESR Max. (Ω) @100kHz
TEP335(*)006	A	3.3	0.5	6	13
TEP475(*)006	A	4.7	0.5	6	10
TEP685(*)006	A	6.8	0.5	6	8
TEP106(*)006	B	10	0.5	8	6
TEP156(*)006	C	15	0.8	8	5
TEP226(*)006	D	22	1.1	8	3.7
TEP336(*)006	E	33	1.7	8	3
TEP476(*)006	F	47	2.4	8	2
TEP686(*)006	G	68	3.4	8	1.8
TEP107(*)006	H	100	5	10	1.6
TEP157(*)006	K	150	7.6	10	0.9
TEP227(*)006	M	220	11	10	0.9
TEP337(*)006	P	330	16.6	10	0.7
TEP335(*)006	A	3.3	0.5	6	13
TEP225(*)010	A	2.2	0.5	6	13
TEP335(*)010	A	3.3	0.5	6	10
TEP475(*)010	A	4.7	0.5	6	8
TEP685(*)010	B	6.8	0.5	6	6
TEP106(*)010	C	10	0.8	8	5
TEP156(*)010	D	15	1.2	8	3.7
TEP226(*)010	E	22	1.7	8	2.7
TEP336(*)010	F	33	2.6	8	2.1
TEP476(*)010	G	47	3.7	8	1.7
TEP686(*)010	H	68	5.4	8	1.3
TEP107(*)010	K	100	8	10	1
TEP157(*)010	N	150	12	10	0.8
TEP227(*)010	P	220	17.6	10	0.6
TEP337(*)010	R	330	20	10	0.5
TEP155(*)016	A	1.5	0.5	4	10
TEP225(*)016	A	2.2	0.5	6	8
TEP335(*)016	A	3.3	0.5	6	6
TEP475(*)016	B	4.7	0.6	6	5
TEP685(*)016	C	6.8	0.8	6	4
TEP106(*)016	D	10	1.2	8	3.2
TEP156(*)016	E	15	1.9	8	2.5
TEP226(*)016	F	22	2.8	8	2
TEP336(*)016	F	33	4.2	8	1.6
TEP476(*)016	J	47	6	8	1.3
TEP686(*)016	L	68	8.7	8	1
TEP107(*)016	N	100	12.8	10	0.8
TEP157(*)016	N	150	19.2	10	0.6
TEP227(*)016	R	220	20	10	0.5
TEP105(*)020	A	1	0.5	4	10
TEP155(*)020	A	1.5	0.5	4	9
TEP225(*)020	A	2.2	0.5	6	7
TEP335(*)020	B	3.3	0.5	6	5.5
TEP475(*)020	C	4.7	0.7	6	4.5
TEP685(*)020	D	6.8	1	6	3.6
TEP106(*)020	E	10	1.6	8	2.9
TEP156(*)020	F	15	2.4	8	2.3

AVX Part No.	Case Size	Cap (µF)	DCL (µA) Max.	DF % Max.	ESR Max. (Ω) @100kHz
TEP226(*)020	H	22	3.5	8	1.8
TEP336(*)020	J	33	5.2	8	1.4
TEP476(*)020	K	47	7.5	8	1.2
TEP686(*)020	N	68	10.8	8	0.9
TEP107(*)020	N	100	16	10	0.6
TEP105(*)025	A	1	0.5	4	10
TEP155(*)025	A	1.5	0.5	4	8
TEP225(*)025	A	2.2	0.5	6	6
TEP335(*)025	B	3.3	0.6	6	5
TEP475(*)025	C	4.7	0.9	6	4
TEP685(*)025	D	6.8	1.3	6	3.1
TEP106(*)025	E	10	2	8	2.5
TEP156(*)025	F	15	3	8	2
TEP226(*)025	H	22	4.4	8	1.5
TEP336(*)025	J	33	6.6	8	1.2
TEP476(*)025	M	47	9.4	8	1
TEP686(*)025	N	68	13.6	8	0.8
TEP104(*)035	A	0.1	0.5	4	26
TEP154(*)035	A	0.15	0.5	4	21
TEP224(*)035	A	0.22	0.5	4	17
TEP334(*)035	A	0.33	0.5	4	15
TEP474(*)035	A	0.47	0.5	4	13
TEP684(*)035	A	0.68	0.5	4	10
TEP105(*)035	A	1	0.5	4	8
TEP155(*)035	A	1.5	0.5	4	6
TEP225(*)035	B	2.2	0.6	6	5
TEP335(*)035	C	3.3	0.9	6	4
TEP475(*)035	E	4.7	1.3	6	3
TEP685(*)035	F	6.8	1.9	6	2.5
TEP106(*)035	F	10	2.8	8	2
TEP156(*)035	H	15	4.2	8	1.6
TEP226(*)035	K	22	6.1	8	1.3
TEP336(*)035	M	33	9.2	8	1
TEP476(*)035	N	47	10	8	0.8
TEP104(*)050	A	0.1	0.5	4	26
TEP154(*)050	A	0.15	0.5	4	21
TEP224(*)050	A	0.22	0.5	4	17
TEP334(*)050	A	0.33	0.5	4	15
TEP474(*)050	A	0.47	0.5	4	13
TEP684(*)050	B	0.68	0.5	4	10
TEP105(*)050	C	1	0.5	4	8
TEP155(*)050	D	1.5	0.6	4	6
TEP225(*)050	E	2.2	0.8	6	3.5
TEP335(*)050	F	3.3	1.3	6	3
TEP475(*)050	G	4.7	1.8	6	2.5
TEP685(*)050	H	6.8	2.7	6	2
TEP106(*)050	J	10	4	8	1.6
TEP156(*)050	K	15	6	8	1.2
TEP226(*)050	L	22	8.8	8	1

Dipped Radial Capacitors



Tape and Reel Packaging

SOLID TANTALUM RESIN DIPPED TAP/TEP

TAPE AND REEL PACKAGING FOR AUTOMATIC COMPONENT INSERTION

TAP/TEP types are all offered on radial tape, in reel or 'ammo' pack format for use on high speed radial automatic insertion equipment, or preforming machines.

The tape format is compatible with EIA 468A standard for component taping set out by major manufacturers of radial automatic insertion equipment.

TAP/TEP – available in three formats. See page 202 for dimensions.

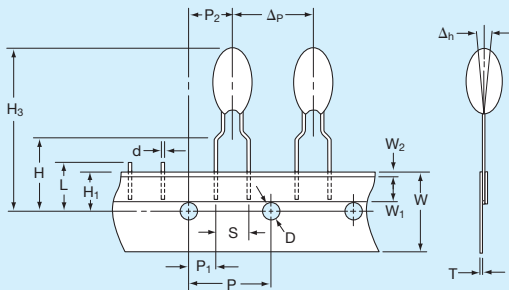

'B' wires for normal automatic insertion on 5mm pitch.

BRW suffix for reel
BRS suffix for 'ammo' pack
Available in case sizes A - J

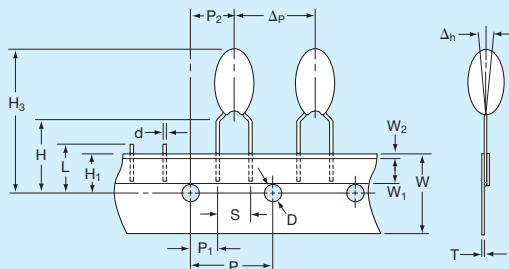

'C' wires for preforming.

CRW suffix for reel
CRS suffix for 'ammo' pack
Available in case sizes A - R

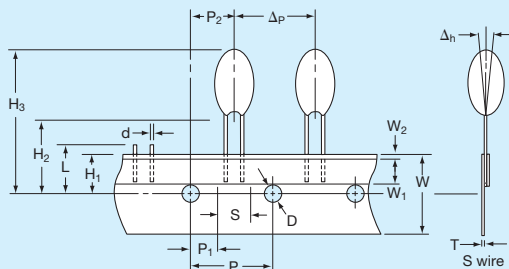

'S' and 'D' wire for special applications, automatic insertion on 2.5mm pitch.

SRW, DTW suffix for reel
SRS, DTS suffix for 'ammo' pack
Available in case sizes A - J

Dipped Radial Capacitors



Tape and Reel Packaging

SOLID TANTALUM RESIN DIPPED TAP/TEP

CASE DIMENSIONS: millimeters (inches)

Description	Code	Dimension
Feed hole pitch	P	12.7 ± 0.30 (0.500 ± 0.010)
Hole center to lead	P ₁	3.85 ± 0.70 (0.150 ± 0.030) to be measured at bottom of clench
		5.05 ± 1.00 (0.200 ± 0.040) for S wire
Hole center to component center	P ₂	6.35 ± 0.40 (0.250 ± 0.020)
Change in pitch	p	± 1.00 (± 0.040)
Lead diameter	d	0.50 ± 0.05 (0.020 ± 0.003)
Lead spacing	S	See wire form table
Component alignment	h	0 ± 2.00 (0 ± 0.080)
Feed hole diameter	D	4.00 ± 0.20 (0.150 ± 0.008)
Tape width	W	18.0 + 1.00 (0.700 + 0.040) - 0.50 - 0.020)
Hold down tape width	W ₁	6.00 (0.240) min.
Hold down tape position	W ₂	1.00 (0.040) max.
Lead wire clench height	H	16.0 ± 0.50 (0.630 ± 0.020)
		19.0 ± 1.00 (0.750 ± 0.040) on request
Hole position	H ₁	9.00 ± 0.50 (0.350 ± 0.020)
Base of component height	H ₂	18.0 (0.700) min. (S wire only)
Component height	H ₃	32.25 (1.300) max.
Length of snipped lead	L	11.0 (0.430) max.
Total tape thickness	T	0.70 ± 0.20 (0.030 ± 0.001)
		Carrying card 0.50 ± 0.10 (0.020 ± 0.005)

REEL CONFIGURATION AND DIMENSIONS: millimeters (inches)

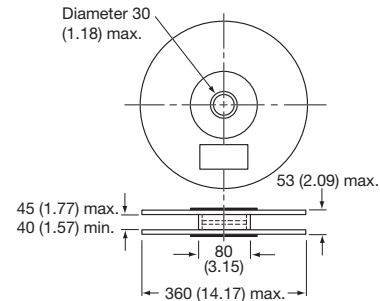

Manufactured from cardboard with plastic hub.

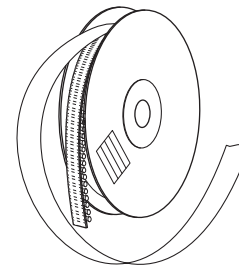

Holding tape outside. Positive terminal leading.

PACKAGING QUANTITIES

For Reels

Style	Case size	No. of pieces
TAP TEP	A	1500
	B, C, D	1250
	E, F	1000
	G, H, J	750
	K, L, M, N, P, R	500

For 'Ammo' pack

Style	Case size	No. of pieces
TAP TEP	A, B, C, D	3000
	E, F, G	2500
	H, J	2000
	K, L, M, N, P, R	1000

For bulk products

Style	Case size	No. of pieces
TAP TEP	A to H	1000
	J to L	500
	M to R	100

AMMO PACK DIMENSIONS

millimeters (inches) max.

Height 360 (14.17), width 360 (14.17), thickness 60 (2.36)

GENERAL NOTES

Resin dipped tantalum capacitors are only available taped in the range of case sizes and in the modular quantities by case size as indicated.

Packaging quantities on tape may vary by ±1%.

Section 4: Technical Summary and Application Guidelines



INTRODUCTION

Tantalum capacitors are manufactured from a powder of pure tantalum metal. OxiCap® - niobium oxide capacitor is made from niobium oxide NbO powder. The typical particle size is between 2 and 10 μm.

Figure below shows typical powders. Note the very great difference in particle size between the powder CVs/g.

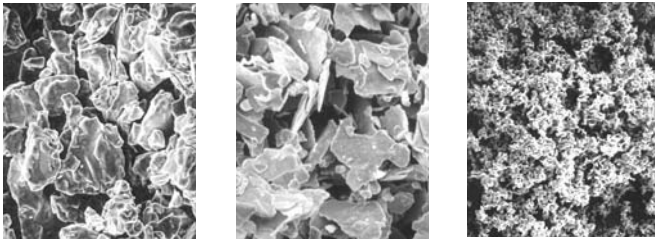

4000μFV

20000μFV

50000μFV

Figure 1a. Tantalum powder

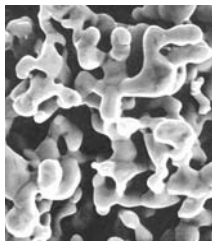

Figure 1b. Niobium Oxide powder

The powder is compressed under high pressure around a Tantalum or Niobium wire (known as the Riser Wire) to form a “pellet”. The riser wire is the anode connection to the capacitor.

This is subsequently vacuum sintered at high temperature (typically 1200 - 1800°C) which produces a mechanically strong pellet and drives off any impurities within the powder.

During sintering the powder becomes a sponge like structure with all the particles interconnected in a huge lattice.

This structure is of high mechanical strength and density, but is also highly porous giving a large internal surface area (see Figure 2).

The larger the surface area the larger the capacitance. Thus high CV/g (capacitance voltage product per gram) powders, which have a low average particle size, are used for low voltage, high capacitance parts.

By choosing which powder and sinter temperature is used to produce each capacitance/voltage rating the surface area can be controlled.

The following example uses a 220μF 6V capacitor to illustrate the point.

$$C = \frac{\epsilon_0 \epsilon_r A}{d}$$

where ϵ_0 is the dielectric constant of free space (8.855 x 10⁻¹² Farads/m)

ϵ_r is the relative dielectric constant

= 27 for Tantalum Pentoxide

= 41 for Niobium Pentoxide

d is the dielectric thickness in meters

C is the capacitance in Farads

and A is the surface area in meters

Rearranging this equation gives:

$$A = \frac{Cd}{\epsilon_0 \epsilon_r}$$

thus for a 220μF/6V capacitor the surface area is 346 square centimeters, or nearly a half times the size of this page.

The dielectric is then formed over all the Tantalum or niobium oxide surfaces by the electrochemical process of anodization. To activate this, the “pellet” is dipped into a very weak solution of phosphoric acid.

The dielectric thickness is controlled by the voltage applied during the forming process. Initially the power supply is kept in a constant current mode until the correct thickness of dielectric has been reached (that is the voltage reaches the ‘forming voltage’), it then switches to constant voltage mode and the current decays to close to zero.

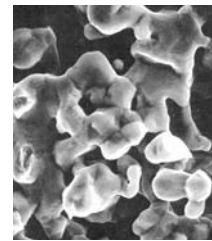
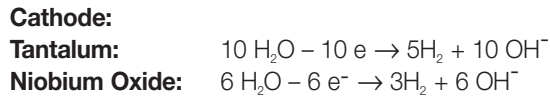
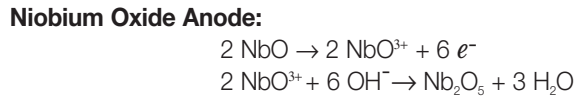
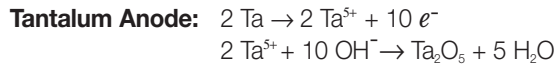

Figure 2. Sintered Anode

Technical Summary and Application Guidelines



The chemical equations describing the process are as follows:



The oxide forms on the surface of the Tantalum or Niobium Oxide but it also grows into the material. For each unit of oxide two thirds grows out and one third grows in. It is for this reason that there is a limit on the maximum voltage rating of Tantalum & Niobium Oxide capacitors with present technology powders (see Figure 3).

The dielectric operates under high electrical stress. Consider a 220µF 6V part:

Formation voltage = Formation Ratio x Working Voltage
 = 3.5 x 6
 = 21 Volts

Tantalum:
 The pentoxide (Ta_2O_5) dielectric grows at a rate of 1.7×10^{-9} m/V

Dielectric thickness (d) = $21 \times 1.7 \times 10^{-9}$
 = 0.036 µm

Electric Field strength = Working Voltage / d
 = 167 KV/mm

Niobium Oxide:
 The niobium oxide (Nb_2O_5) dielectric grows at a rate of 2.4×10^{-9} m/V

Dielectric thickness (d) = $21 \times 2.4 \times 10^{-9}$
 = 0.050 µm

Electric Field strength = Working Voltage / d
 = 120 KV/mm

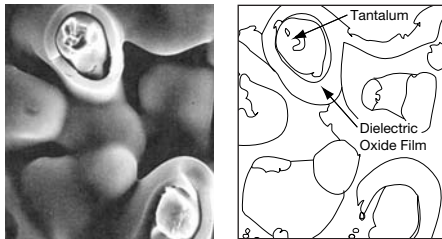
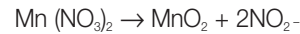

Figure 3. Dielectric layer

The next stage is the production of the cathode plate. This is achieved by pyrolysis of Manganese Nitrate into Manganese Dioxide.

The “pellet” is dipped into an aqueous solution of nitrate and then baked in an oven at approximately 250°C to produce the dioxide coat. The chemical equation is:



This process is repeated several times through varying specific densities of nitrate to build up a thick coat over all internal and external surfaces of the “pellet”, as shown in Figure 4.

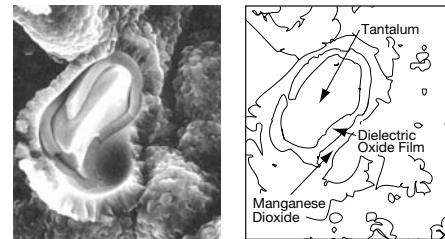

Figure 4. Manganese Dioxide Layer

The “pellet” is then dipped into graphite and silver to provide a good connection to the Manganese Dioxide cathode plate. Electrical contact is established by deposition of carbon onto the surface of the cathode. The carbon is then coated with a conductive material to facilitate connection to the cathode termination (see Figure 5). Packaging is carried out to meet individual specifications and customer requirements. This manufacturing technique is adhered to for the whole range of AVX Tantalum capacitors, which can be subdivided into four basic groups: Chip / Resin dipped / Rectangular boxed / Axial.

Further information on production of Tantalum Capacitors can be obtained from the technical paper “Basic Tantalum Technology”, by John Gill, available from your local AVX representative.

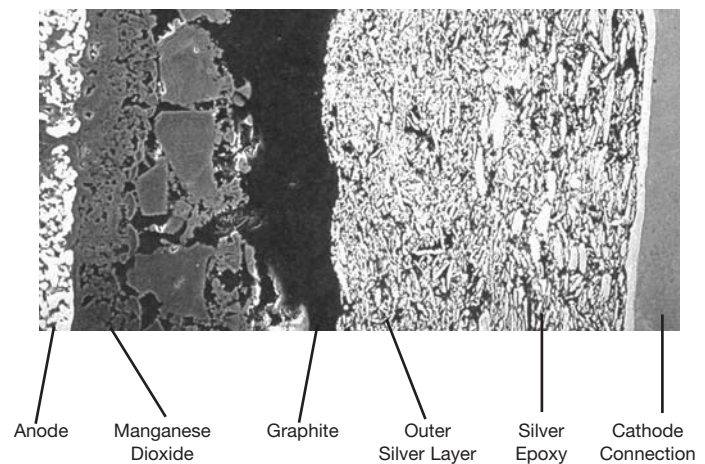

Figure 5. Cathode Termination

Technical Summary and Application Guidelines



SECTION 1

ELECTRICAL CHARACTERISTICS AND EXPLANATION OF TERMS

1.1 CAPACITANCE

1.1.1 Rated capacitance (C_R).

This is the nominal rated capacitance. For tantalum and OxiCap® capacitors it is measured as the capacitance of the equivalent series circuit at 25°C using a measuring bridge supplied by a 0.5V rms 120Hz sinusoidal signal, free of harmonics with a bias of 2.2Vd.c.

1.1.2 Capacitance tolerance.

This is the permissible variation of the actual value of the capacitance from the rated value. For additional reading, please consult the AVX technical publication “Capacitance Tolerances for Solid Tantalum Capacitors”.

1.1.3 Temperature dependence of capacitance.

The capacitance of a tantalum capacitor varies with temperature. This variation itself is dependent to a small extent on the rated voltage and capacitor size.

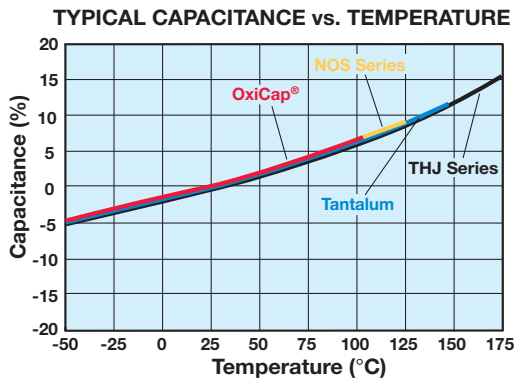

1.1.4 Frequency dependence of the capacitance.

The effective capacitance decreases as frequency increases. Beyond 100kHz the capacitance continues to drop until resonance is reached (typically between 0.5 - 5MHz depending on the rating). Beyond the resonant frequency the device becomes inductive.

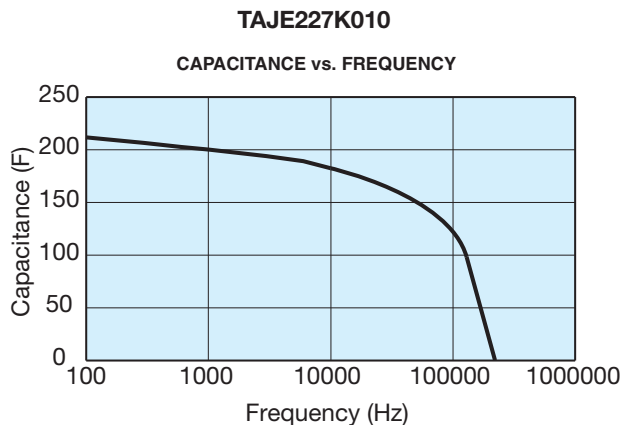

For individual part number please refer to SpiTan Software for frequency and temperature behavior found on AVX Corporation website.

1.2 VOLTAGE

1.2.1 Rated d.c. voltage (V_R).

This is the rated d.c. voltage for continuous operation up to 85°C (up to 40°C for TLJ, TLN, NLJ series).

Operating voltage consists of the sum of DC bias voltage and ripple peak voltage. The peak voltage should not exceed the category voltage. For recommended voltage (application) derating refer to figure 2c of the SECTION 3.

1.2.2 Category voltage (V_C).

This is the maximum voltage that may be applied continuously to a capacitor. It is equal to the rated voltage up to +85°C (up to 40°C for TLJ, TLN, NLJ series), beyond which it is subject to a linear derating, to 2/3 V_R at 125°C for tantalum and 2/3 V_R at 105°C for OxiCap®.

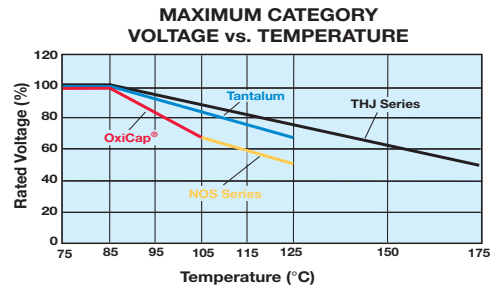

1.2.3 Surge voltage (V_S).

This is the highest voltage that may be applied to a capacitor for short periods of time in circuits with minimum series resistance of 33Ohms (CECC states 1kΩ). The surge voltage may be applied up to 10 times in an hour for periods of up to 30 seconds at a time. The surge voltage must not be used as a parameter in the design of circuits in which, in the normal course of operation, the capacitor is periodically charged and discharged.

85°C Tantalum		125°C Tantalum*	
Rated Voltage V_R	Surge Voltage V_S	Category Voltage V_C	Surge Voltage V_S
2	2.7	1.3	1.7
2.5	3.3	1.7	2.2
3	3.9	2	2.6
4	5.2	2.7	3.4
5	6.5	3.3	4
6.3	8	4	5
10	13	7	8
16	20	10	13
20	26	13	16
25	32	17	20
35	46	23	28
50	65	33	40

85°C OxiCap®		105°C OxiCap®	
Rated Voltage V_R	Surge Voltage V_S	Category Voltage V_C	Surge Voltage V_S
1.8	2.3	1.2	1.6
2.5	3.3	1.7	2.2
4	5.2	2.7	3.4
6.3	8	4	5
10	13	7	8

*For THJ 175°C Category & Surge voltage see THJ section on pages 103-107.



1.2.4 Effect of surges

The solid Tantalum and OxiCap® capacitors have a limited ability to withstand voltage and current surges. This is in common with all other electrolytic capacitors and is due to the fact that they operate under very high electrical stress across the dielectric. For example a 6 volt tantalum capacitor has an Electrical Field of 167 kV/mm when operated at rated voltage. OxiCap® capacitors operate at electrical field significantly less than 167 kV/mm.

It is important to ensure that the voltage across the terminals of the capacitor never exceeds the specified surge voltage rating.

Solid tantalum capacitors and OxiCap® have a self healing ability provided by the Manganese Dioxide semiconducting layer used as the negative plate. However, this is limited in low impedance applications. In the case of low impedance circuits, the capacitor is likely to be stressed by current surges.

Derating the capacitor increases the reliability of the component. (See Figure 2b page 213). The “AVX Recommended Derating Table” (page 215) summarizes voltage rating for use on common voltage rails, in low impedance applications for both Tantalum and OxiCap® capacitors.

In circuits which undergo rapid charge or discharge a protective resistor of 1Ω/V is recommended. If this is impossible, a derating factor of up to 70% should be used on tantalum capacitors. OxiCap® capacitors can be used with derating of 20% minimum.

In such situations a higher voltage may be needed than is available as a single capacitor. A series combination should be used to increase the working voltage of the equivalent capacitor: For example, two 22μF 25V parts in series is equivalent to one 11μF 50V part. For further details refer to J.A. Gill's paper “Investigation into the Effects of Connecting Tantalum Capacitors in Series”, available from AVX offices worldwide.

NOTE:

While testing a circuit (e.g. at ICT or functional) it is likely that the capacitors will be subjected to large voltage and current transients, which will not be seen in normal use. These conditions should be borne in mind when considering the capacitor's rated voltage for use. These can be controlled by ensuring a correct test resistance is used.

1.2.5 Reverse voltage and Non-Polar operation.

The values quoted are the maximum levels of reverse voltage which should appear on the capacitors at any time. These limits are based on the assumption that the capacitors are polarized in the correct direction for the majority of their working life. They are intended to cover short term reversals of polarity such as those occurring during switching transients or during a minor portion of an impressed waveform. Continuous application of reverse voltage without normal polarization will result in a degradation of leakage current. In conditions under which continuous application of a reverse

voltage could occur two similar capacitors should be used in a back-to-back configuration with the negative terminations connected together. Under most conditions this combination will have a capacitance one half of the nominal capacitance of either capacitor. Under conditions of isolated pulses or during the first few cycles, the capacitance may approach the full nominal value. The reverse voltage ratings are designed to cover exceptional conditions of small level excursions into incorrect polarity. The values quoted are not intended to cover continuous reverse operation.

The peak reverse voltage applied to the capacitor must not exceed:

10% of the rated d.c. working voltage to a maximum of 1.0v at 25°C

3% of the rated d.c. working voltage to a maximum of 0.5v at 85°C

1% of the rated d.c. working voltage to a maximum of 0.1v at 125°C (0.1v at 150°C THJ Series)

Note: Capacitance and DF values of OxiCap® may exceed specification limits under these conditions.

LEAKAGE CURRENT vs. BIAS VOLTAGE

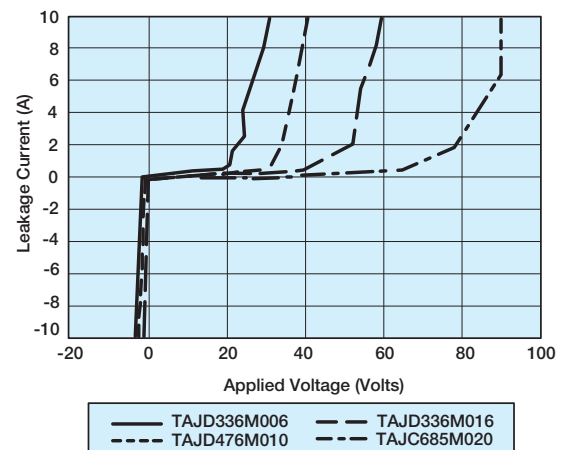

1.2.6 Superimposed A.C. Voltage (Vr.m.s.) - Ripple Voltage.

This is the maximum r.m.s. alternating voltage; superimposed on a d.c. voltage, that may be applied to a capacitor. The sum of the d.c. voltage and peak value of the superimposed a.c. voltage must not exceed the category voltage, v.c.

Full details are given in Section 2.

1.2.7 Forming voltage.

This is the voltage at which the anode oxide is formed. The thickness of this oxide layer is proportional to the formation voltage for a capacitor and is a factor in setting the rated voltage.

1.3 DISSIPATION FACTOR AND TANGENT OF LOSS ANGLE (TAN D)

1.3.1 Dissipation factor (D.F.).

Dissipation factor is the measurement of the tangent of the loss angle ($\tan \delta$) expressed as a percentage. The measurement of DF is carried out using a measuring bridge that supplies a 0.5V rms 120Hz sinusoidal signal, free of harmonics with a bias of 2.2Vdc. The value of DF is temperature and frequency dependent.

Note: For surface mounted products the maximum allowed DF values are indicated in the ratings table and it is important to note that these are the limits met by the component AFTER soldering onto the substrate.

1.3.2 Tangent of Loss Angle ($\tan \delta$).

This is a measurement of the energy loss in the capacitor. It is expressed, as $\tan \delta$ and is the power loss of the capacitor divided by its reactive power at a sinusoidal voltage of specified frequency. Terms also used are power factor, loss factor and dielectric loss. $\cos(90 - \delta)$ is the true power factor. The measurement of $\tan \delta$ is carried out using a measuring bridge that supplies a 0.5V rms 120Hz sinusoidal signal, free of harmonics with a bias of 2.2Vdc.

1.3.3 Frequency dependence of Dissipation Factor.

Dissipation Factor increases with frequency as shown in the typical curves that are for tantalum and OxiCap® capacitors identical:

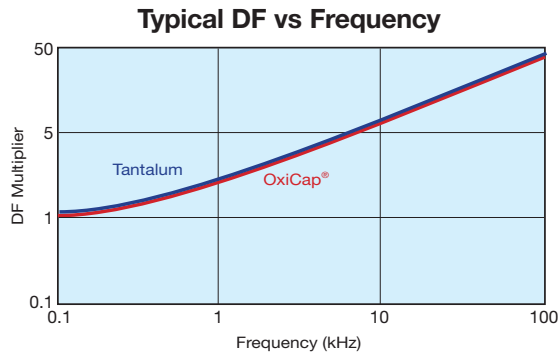

1.3.4 Temperature dependence of Dissipation Factor.

Dissipation factor varies with temperature as the typical curves show. These plots are identical for both Tantalum and OxiCap® capacitors. For maximum limits please refer to ratings tables.

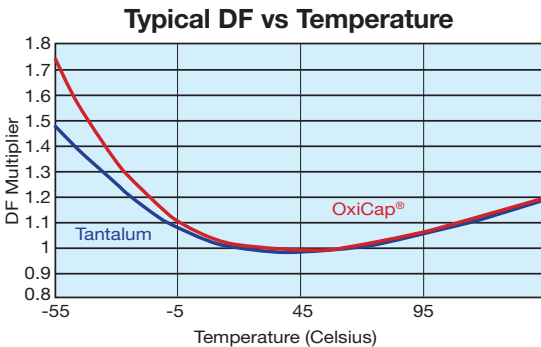

1.4 IMPEDANCE, (Z) AND EQUIVALENT SERIES RESISTANCE (ESR)

1.4.1 Impedance, Z.

This is the ratio of voltage to current at a specified frequency. Three factors contribute to the impedance of a Tantalum capacitor; the resistance of the semiconductor layer; the capacitance value and the inductance of the electrodes and leads.

At high frequencies the inductance of the leads becomes a limiting factor. The temperature and frequency behavior of these three factors of impedance determine the behavior of the impedance Z. The impedance is measured at 25°C and 100kHz.

1.4.2 Equivalent Series Resistance, ESR.

Resistance losses occur in all practical forms of capacitors. These are made up from several different mechanisms, including resistance in components and contacts, viscous forces within the dielectric and defects producing bypass current paths. To express the effect of these losses they are considered as the ESR of the capacitor. The ESR is frequency dependent and can be found by using the relationship;

$$ESR = \frac{\tan \delta}{2\pi f C}$$

Where f is the frequency in Hz, and C is the capacitance in farads.

The ESR is measured at 25°C and 100kHz.

ESR is one of the contributing factors to impedance, and at high frequencies (100kHz and above) it becomes the dominant factor. Thus ESR and impedance become almost identical, impedance being only marginally higher.

1.4.3 Frequency dependence of Impedance and ESR.

ESR and Impedance both increase with decreasing frequency. At lower frequencies the values diverge as the extra contributions to impedance (due to the reactance of the capacitor) become more significant. Beyond 1MHz (and beyond the resonant point of the capacitor) impedance again increases due to the inductance of the capacitor. Typical ESR and Impedance values are similar for both tantalum and niobium oxide materials and thus the same charts are valid for both for Tantalum and OxiCap® capacitors.

Typical ESR vs Frequency

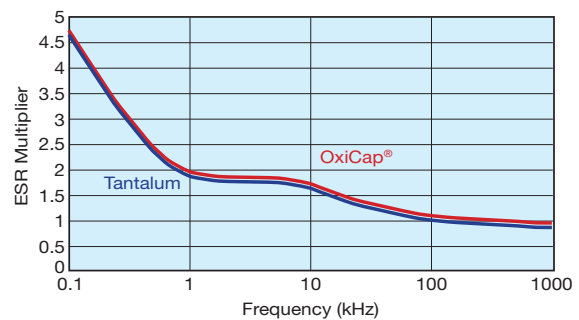

Typical Impedance vs Frequency

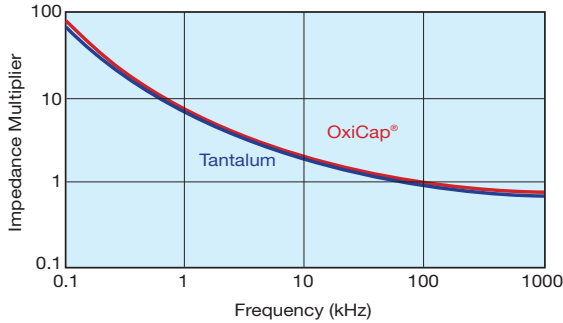

1.4.4 Temperature dependence of the Impedance and ESR.

At 100kHz, impedance and ESR behave identically and decrease with increasing temperature as the typical curves show.

Typical 100kHz ESR vs Temperature

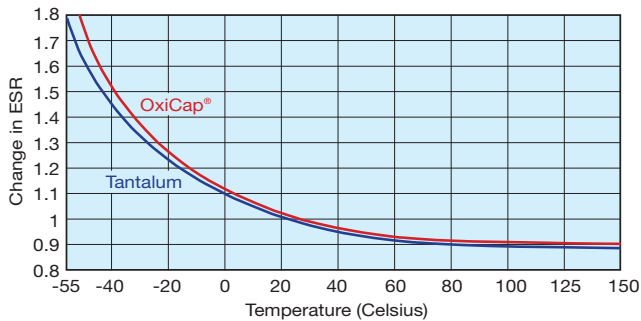

1.5 D.C. LEAKAGE CURRENT

1.5.1 Leakage current.

The leakage current is dependent on the voltage applied, the elapsed time since the voltage was applied and the component temperature. It is measured at +20°C with the rated voltage applied. A protective resistance of 1000Ω is connected in series with the capacitor in the measuring circuit. Three to five minutes after application of the rated voltage the leakage current must not exceed the maximum values indicated in the ratings table. Leakage current is referenced as DCL (for Direct Current Leakage). The default maximum limit for DCL Current is given by $DCL = 0.01CV$, where DCL is in microamperes, and C is the capacitance rating in microfarads, and V is the voltage rating in volts. DCL of tantalum capacitors vary within range of 0.01 - 0.1CV or 0.5μA (whichever is the greater). And 0.02 - 0.1CV or 1.0μA (whichever is the greater) for OxiCap® capacitors.

Reforming of Tantalum or OxiCap® capacitors is unnecessary even after prolonged storage periods without the application of voltage.

1.5.2 Temperature dependence of the leakage current.

The leakage current increases with higher temperatures; typical values are shown in the graph. For operation between 85°C and 125°C, the maximum working voltage must be derated and can be found from the following formula.

$$V_{max} = \left(1 - \frac{T - 85}{125}\right) \times V_R$$

where T is the required operating temperature.

LEAKAGE CURRENT vs. TEMPERATURE

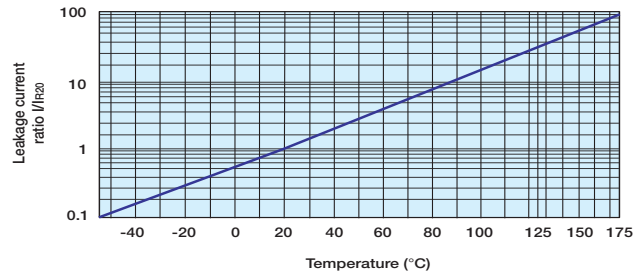

1.5.3 Voltage dependence of the leakage current.

The leakage current drops rapidly below the value corresponding to the rated voltage V_R when reduced voltages are applied. The effect of voltage derating on the leakage current is shown in the graph. This will also give a significant increase in the reliability for any application. See Section 3.1 (page 213) for details.

LEAKAGE CURRENT vs. RATED VOLTAGE

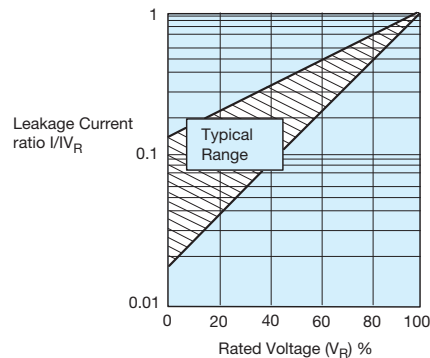

For input condition of fixed application voltage and including median curve of the Leakage current vs. Rated voltage graph displayed above we can evaluate following curve.

Technical Summary and Application Guidelines



LEAKAGE CURRENT MULTIPLIER vs. VOLTAGE DERATING for FIXED APPLICATION VOLTAGE V_A

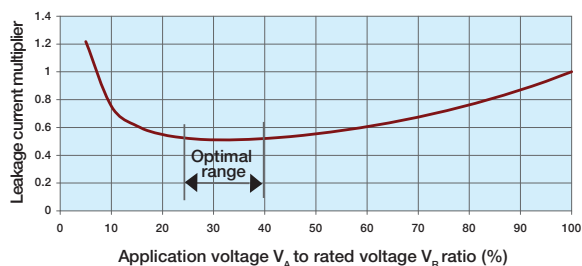

We can identify the range of V_A/V_R (derating) values with minimum actual DCL as the “optimal” range. Therefore the minimum DCL is obtained when capacitor is used at 25 to 40 % of rated voltage - when the rated voltage of the capacitor is 2.5 to 4 times higher than actual application voltage.

For additional information on Leakage Current, please consult the AVX technical publication “Analysis of Solid Tantalum Capacitor Leakage Current” by R. W. Franklin.

1.5.4 Ripple current.

The maximum ripple current allowed is derived from the power dissipation limits for a given temperature rise above ambient temperature (please refer to Section 2, pages 210-212).

1.6 SELF INDUCTANCE (ESL)

The self-inductance value (ESL) can be important for resonance frequency evaluation. See figure below typical ESL values per case size.

TAJ/TMJ/TPS/TRJ/THJ/TLJ/TCJ/TCQ/TCR/ NLJ/NOJ/NOS

Case Size	Typical Self Inductance value (nH)	Case Size	Typical Self Inductance value (nH)	Case Size	Typical Self Inductance value (nH)
A	1.8	H	1.8	U	2.4
B	1.8	K	1.8	V	2.4
C	2.2	N	1.4	W	2.2
D	2.4	P	1.4	X	2.4
E	2.5	R	1.4	Y	2.4
F	2.2	S	1.8	5	2.4
G	1.8	T	1.8		

TAC/TLC/TPC

Case Size	Typical Self-Inductance value (nH)
A	1.5
B	1.6
D	1.4
E	1.0
H	1.4
I	1.3
J	1.2
K	1.1
L	1.2
M	1.3
R	1.4
T	1.6
U	1.3
V	1.5
Z	1.1

TCM/TPM TRM/NOM

Case Size	Typical Self-Inductance value (nH)
D	1.0
E	2.5
V	2.4
Y	1.0

TLN/TCN/J-CAP™

Case Size	Typical Self-Inductance value (nH)
K	1.0
L	1.0
M	1.3
N	1.3
S	1.0
T	1.0
X	1.8
3	2.0
4	2.2
6	2.5

Technical Summary and Application Guidelines



SECTION 2

A.C. OPERATION, RIPPLE VOLTAGE AND RIPPLE CURRENT

2.1 RIPPLE RATINGS (A.C.)

In an a.c. application heat is generated within the capacitor by both the a.c. component of the signal (which will depend upon the signal form, amplitude and frequency), and by the d.c. leakage. For practical purposes the second factor is insignificant. The actual power dissipated in the capacitor is calculated using the formula:

$$P = I^2 R$$

and rearranged to $I = \text{SQRT}(P/R)$ (Eq. 1)

where I = rms ripple current, amperes
 R = equivalent series resistance, ohms
 U = rms ripple voltage, volts
 P = power dissipated, watts
 Z = impedance, ohms, at frequency under consideration

Maximum a.c. ripple voltage (U_{max}).

From the Ohms' law equation:

$$U_{max} = IR \text{(Eq. 2)}$$

Where P is the maximum permissible power dissipated as listed for the product under consideration (see tables).

However care must be taken to ensure that:

1. The d.c. working voltage of the capacitor must not be exceeded by the sum of the positive peak of the applied a.c. voltage and the d.c. bias voltage.
2. The sum of the applied d.c. bias voltage and the negative peak of the a.c. voltage must not allow a voltage reversal in excess of the "Reverse Voltage".

Historical ripple calculations.

Previous ripple current and voltage values were calculated using an empirically derived power dissipation required to give a 10°C (30°C for polymer) rise of the capacitors body temperature from room temperature, usually in free air. These values are shown in Table I. Equation 1 then allows the maximum ripple current to be established, and Equation 2, the maximum ripple voltage. But as has been shown in the AVX article on thermal management by I. Salisbury, the thermal conductivity of a Tantalum chip capacitor varies considerably depending upon how it is mounted.

Table I: Power Dissipation Ratings (In Free Air)

TAJ/TMJ/TPS/TPM/TRJ/TRM/THJ/TLJ/TLN/TCJ/TCM/TCN/J-CAP™/TCQ/TCR/NLJ/NOJ/NOS/NOM Series Molded Chip

Case Size	Max. power dissipation (W)						
	Tantalum			Polymer		OxiCap®	
	TAJ/TMJ/TPS TRJ/THJ TLJ	TLN	TPM TRM	TCJ TCN J-CAP™ TCQ TCR	TCM	NLJ NOJ NOS	NOM
A	0.075	—	—	0.100	—	0.090	—
B	0.085	—	—	0.125	—	0.102	—
C	0.110	—	—	0.175	—	0.132	—
D	0.150	—	0.255	0.225	—	0.180	—
E	0.165	—	0.270	0.250	0.410	0.198	0.324
F	0.100	—	—	0.150	—	0.120	—
G	0.070	0.060	—	0.100	—	0.084	—
H	0.080	0.070	—	0.100	—	0.096	—
K	0.065	0.055	—	0.090	—	0.078	—
L	0.070	0.060	—	0.095	—	0.084	—
M	—	0.040	—	0.080	—	—	—
N	0.050	0.040	—	0.080	—	—	—
P	0.060	—	—	0.090	—	0.072	—
R	0.055	—	—	0.085	—	0.066	—
S	0.065	0.055	—	0.095	—	0.078	—
T	0.080	0.070	—	0.100	—	0.096	—
U	0.165	—	—	0.380	—	—	—
V	0.250	—	0.285	0.360	0.420	0.300	—
W	0.090	—	—	0.130	—	0.108	—
X	0.100	—	—	0.175	—	0.120	—
Y	0.125	0.115	0.210	0.185	—	0.150	—
3	—	—	—	0.145	—	—	—
4	—	0.165	—	0.190	—	—	—
5	—	—	—	0.160	—	—	—
6	—	0.230	—	—	—	—	—

TACmicrochip® Series

Case Size	Max. power dissipation (W)
A	0.040
B	0.040
D	0.035
E	0.010
H	0.040
I	0.035
J	0.020
K	0.015
L	0.025
M	0.030
Q	0.040
R	0.045
T	0.040
U	0.035
V	0.035
X	0.040
Z	0.020

NLJ/NOJ/NOS/NOM

Temperature correction factor for ripple current	
Temp. °C	Factor
+25	1.00
+55	0.95
+85	0.90
+105	0.40
+125 (NOS,NOM)	0.40

TAJ/TPS/TPM/TRJ/TRM/THJ/TLJ/TLN

Temp °C	Correction Factor for ripple current	Correction Factor for Power Dissipation	Max. Temperature rise °C
up to 25°C	1.00	1.00	10
+55	0.95	0.90	9
+85	0.90	0.81	8.1
+105	0.65	0.42	4.2
+115	0.49	0.24	2.4
+125	0.40	0.16	1.6
+175 (THJ)	0.20	0.04	0.4
+200 (THJ)	0.10	0.01	0.1

TCJ/TCM/TCN/J-CAP™/TCQ/TCR

Temp °C	Correction Factor for ripple current	Correction Factor for Power Dissipation	Max. Temperature rise °C
up to 45°C	1.00	1.00	30
+85	0.70	0.49	15
+105	0.45	0.20	6
+125	0.25	0.06	1.8

Technical Summary and Application Guidelines



A piece of equipment was designed which would pass sine and square wave currents of varying amplitudes through a biased capacitor. The temperature rise seen on the body for the capacitor was then measured using an infra-red probe. This ensured that there was no heat loss through any thermo-couple attached to the capacitor's surface.

Results for the C, D and E case sizes

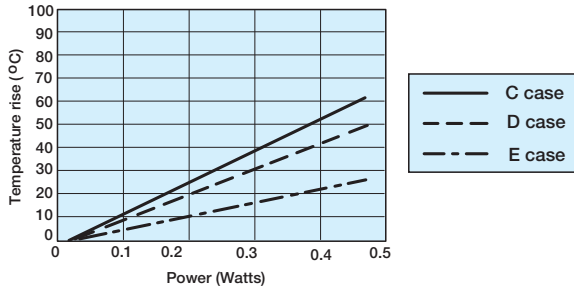

Several capacitors were tested and the combined results are shown above. All these capacitors were measured on FR4 board, with no other heat sinking. The ripple was supplied at various frequencies from 1kHz to 1MHz.

As can be seen in the figure above, the average P_{max} value for the C case capacitors was 0.11 Watts. This is the same as that quoted in Table I.

The D case capacitors gave an average P_{max} value 0.125 Watts. This is lower than the value quoted in the Table I by 0.025 Watts. The E case capacitors gave an average P_{max} of 0.200 Watts that was much higher than the 0.165 Watts from Table I.

If a typical capacitor's ESR with frequency is considered, e.g. figure below, it can be seen that there is variation. Thus for a set ripple current, the amount of power to be dissipated by the capacitor will vary with frequency. This is clearly shown in figure in top of next column, which shows that the surface temperature of the unit raises less for a given value of ripple current at 1MHz than at 100kHz.

The graph below shows a typical ESR variation with frequency. Typical ripple current versus temperature rise for 100kHz and 1MHz sine wave inputs.

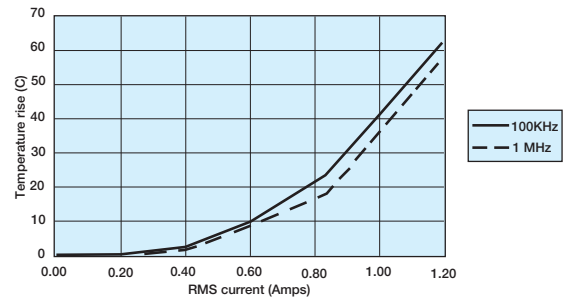
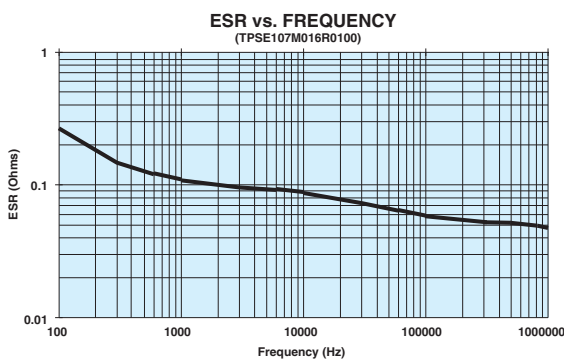

If I^2R is then plotted it can be seen that the two lines are in fact coincident, as shown in figure below.

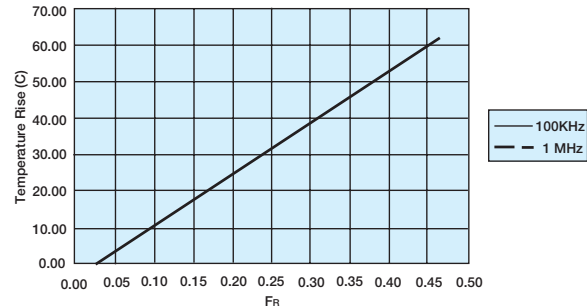

Example

A Tantalum capacitor is being used in a filtering application, where it will be required to handle a 2 Amp peak-to-peak, 200kHz square wave current.

A square wave is the sum of an infinite series of sine waves at all the odd harmonics of the square waves fundamental frequency. The equation which relates is:

$$I_{square} = I_{pk} \sin(2\pi f) + I_{pk} \sin(6\pi f) + I_{pk} \sin(10\pi f) + I_{pk} \sin(14\pi f) + \dots$$

Thus the special components are:

Frequency	Peak-to-peak current (Amps)	RMS current (Amps)
200 KHz	2.000	0.707
600 KHz	0.667	0.236
1 MHz	0.400	0.141
1.4 MHz	0.286	0.101

Let us assume the capacitor is a TAJD686M006
Typical ESR measurements would yield.

Frequency	Typical ESR (Ohms)	Power (Watts) $I_{rms}^2 \times ESR$
200 KHz	0.120	0.060
600 KHz	0.115	0.006
1 MHz	0.090	0.002
1.4 MHz	0.100	0.001

Thus the total power dissipation would be 0.069 Watts.

From the D case results shown in figure top of previous column, it can be seen that this power would cause the capacitors surface temperature to rise by about 5°C. For additional information, please refer to the AVX technical publication "Ripple Rating of Tantalum Chip Capacitors" by R.W. Franklin.

Technical Summary and Application Guidelines



2.2 OxiCap® RIPPLE RATING

OxiCap® capacitors showing 20% higher power dissipation allowed compared to tantalum capacitors as a result of twice higher specific heat of niobium oxide compared to Tantalum

powders. (Specific heat is related to energy necessary to heat a defined volume of material to a specified temperature.)

2.3 THERMAL MANAGEMENT

The heat generated inside a tantalum capacitor in a.c. operation comes from the power dissipation due to ripple current. It is equal to I^2R , where I is the rms value of the current at a given frequency, and R is the ESR at the same frequency with an additional contribution due to the leakage current. The heat will be transferred from the outer surface by conduction. How efficiently it is transferred from this point is dependent on the thermal management of the board.

In practice, in a high density assembly with no specific thermal management, the power dissipation required to give a 10°C (30°C for polymer) rise above ambient may be up to a factor of 10 less. In these cases, the actual capacitor temperature should be established (either by thermocouple probe or infra-red scanner) and if it is seen to be above this limit it may be necessary to specify a lower ESR part or a higher voltage rating.

The power dissipation ratings given in Section 2.1 (page 210) are based on free-air calculations. These ratings can be approached if efficient heat sinking and/or forced cooling is used.

Please contact application engineering for details or contact the AVX technical publication entitled "Thermal Management of Surface Mounted Tantalum Capacitors" by Ian Salisbury.

Thermal Dissipation from the Mounted Chip

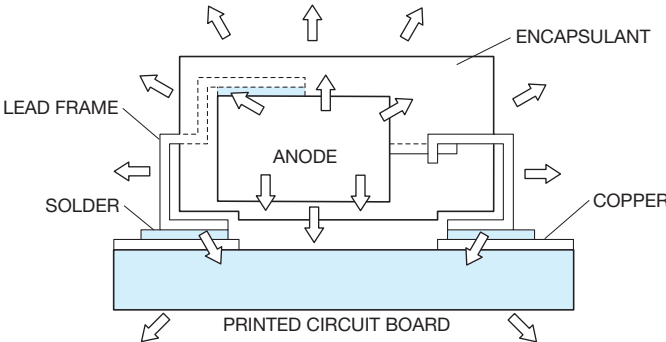

Thermal Impedance Graph with Ripple Current

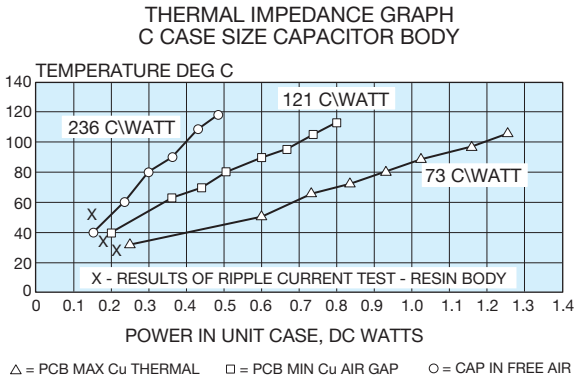

SECTION 3 RELIABILITY AND CALCULATION OF FAILURE RATE

3.1 STEADY-STATE

Both Tantalum and Niobium Oxide dielectric have essentially no wear out mechanism and in certain circumstances is capable of limited self healing. However, random failures can occur in operation. The failure rate of Tantalum capacitors will decrease with time and not increase as with other electrolytic capacitors and other electronic components.

Figure 1. Tantalum and OxiCap® Reliability Curve

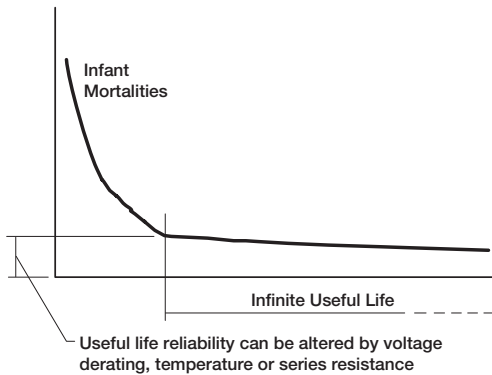

The useful life reliability of the Tantalum and OxiCap® capacitors in steady-state is affected by three factors. The equation from which the failure rate can be calculated is:

$$F = F_V \times F_T \times F_R \times F_B$$

where F_V is a correction factor due to operating voltage/voltage derating

F_T is a correction factor due to operating temperature

F_R is a correction factor due to circuit series resistance

F_B is the basic failure rate level

Base failure rate.

Standard Tantalum conforms to Level M reliability (i.e. 1%/1000 hrs) or better at rated voltage, 85°C and 0.1Ω/volt circuit impedance.

$F_B = 1.0\% / 1000$ hours for TAJ, TPS, TPM, TCJ, TCQ,

TCM, TCN, J-CAP™, TAC

0.5% / 1000 hours for TCR, TMJ, TRJ, TRM, THJ & NOJ

0.2% / 1000 hours for NOS and NOM

TLJ, TLN, TLC and NLJ series of tantalum capacitors are defined at 0.5 x rated voltage at 85°C due to the temperature derating.

$F_B = 0.2\% / 1000$ hours at 85°C and $0.5 \times V_R$ with 0.1Ω/V series impedance with 60% confidence level.

Operating voltage/voltage derating.

If a capacitor with a higher voltage rating than the maximum line voltage is used, then the operating reliability will be improved. This is known as voltage derating.

The graph, Figure 2a, shows the relationship between voltage derating (the ratio between applied and rated voltage) and the failure rate. The graph gives the correction factor F_V for any operating voltage.

Figure 2a. Correction factor to failure rate F_V for voltage derating of a typical component (60% con. level).

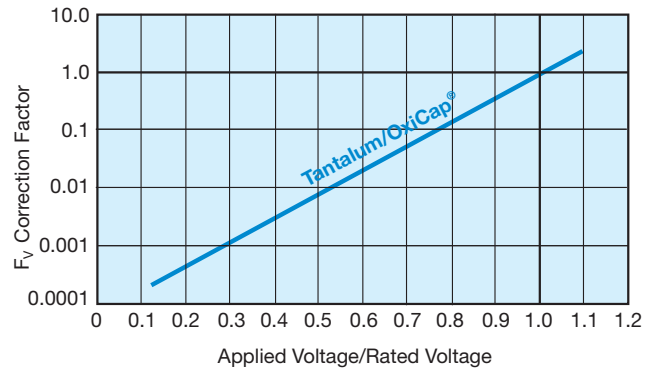

Figure 2b. Gives our recommendation for voltage derating for tantalum capacitors to be used in typical applications.

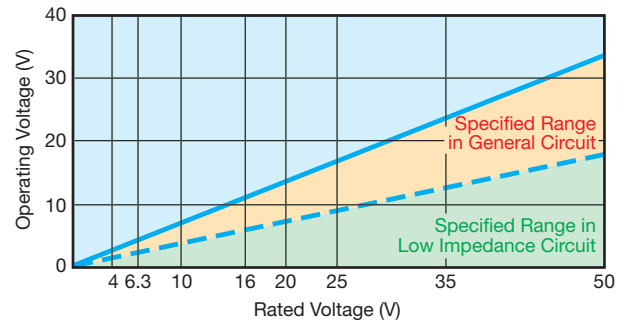
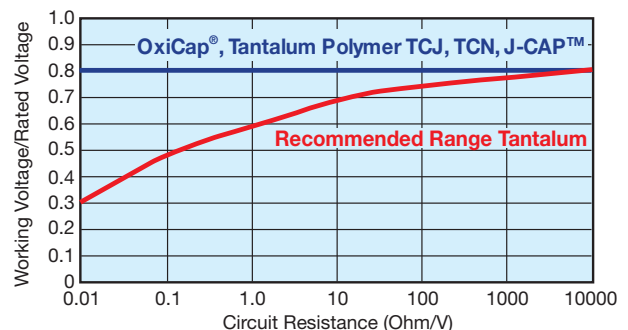

Figure 2c. Gives voltage derating recommendations for tantalum capacitors as a function of circuit impedance.



Technical Summary and Application Guidelines



Operating Temperature.

If the operating temperature is below the rated temperature for the capacitor then the operating reliability will be improved as shown in Figure 3. This graph gives a correction factor F_T for any temperature of operation.

Figure 3: Correction factor to failure rate F_R for ambient temperature T for typical component (60% con. level).

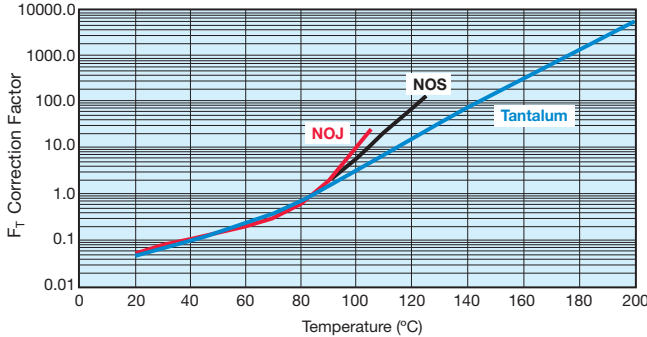

Circuit Impedance.

All solid Tantalum and/or niobium oxide capacitors require current limiting resistance to protect the dielectric from surges. A series resistor is recommended for this purpose. A lower circuit impedance may cause an increase in failure rate, especially at temperatures higher than 20°C. An inductive low impedance circuit may apply voltage surges to the capacitor and similarly a non-inductive circuit may apply current surges to the capacitor, causing localized over-heating and failure. The recommended impedance is 1 Ω per volt. Where this is not feasible, equivalent voltage derating should be used (See MIL HANDBOOK 217E). The graph, Figure 4, shows the correction factor, F_R , for increasing series resistance.

Figure 4. Correction factor to failure rate F_R for series resistance R on basic failure rate F_B for a typical component (60% con. level).

Circuit resistance ohms/volt	F_R
3.0	0.07
2.0	0.1
1.0	0.2
0.8	0.3
0.6	0.4
0.4	0.6
0.2	0.8
0.1	1.0

For circuit impedances below 0.1 ohms per volt, or for any mission critical application, circuit protection should be considered. An ideal solution would be to employ an AVX SMT thin-film fuse in series.

Example calculation.

Consider a 12 volt power line. The designer needs about 10 μ F of capacitance to act as a decoupling capacitor near a video bandwidth amplifier. Thus the circuit impedance will be limited only by the output impedance of the board's power unit and the track resistance. Let us assume it to be about 2 Ohms minimum, i.e. 0.167 Ohms/Volt. The operating temperature range is -25°C to +85°C.

If a 10 μ F 16 Volt capacitor was designed in the operating failure rate would be as follows.

- a) $F_T = 1.0$ @ 85°C
- b) $F_R = 0.85$ @ 0.167 Ohms/Volt
- c) $F_V = 0.08$ @ applied voltage/rated voltage = 75%
- d) $F_B = 1\%/1000$ hours, basic failure rate level

Thus $F = 1.0 \times 0.85 \times 0.08 \times 1 = 0.068\%/1000$ Hours

If the capacitor was changed for a 20 volt capacitor, the operating failure rate will change as shown.

$F_V = 0.018$ @ applied voltage/rated voltage = 60%
 $F = 1.0 \times 0.85 \times 0.018 \times 1 = 0.0153\%/1000$ Hours

3.2 Dynamic.

As stated in Section 1.2.4 (page 206), the solid capacitor has a limited ability to withstand voltage and current surges. Such current surges can cause a capacitor to fail. The expected failure rate cannot be calculated by a simple formula as in the case of steady-state reliability. The two parameters under the control of the circuit design engineer known to reduce the incidence of failures are derating and series resistance.

The table below summarizes the results of trials carried out at AVX with a piece of equipment, which has very low series resistance with no voltage derating applied. That is if the capacitor was tested at its rated voltage. It has been tested on tantalum capacitors, however the conclusions are valid for both tantalum and OxiCap® capacitors.

Results of production scale derating experiment

Capacitance and Voltage	Number of units tested	50% derating applied	No derating applied
47 μ F 16V	1,547,587	0.03%	1.1%
100 μ F 10V	632,876	0.01%	0.5%
22 μ F 25V	2,256,258	0.05%	0.3%

As can clearly be seen from the results of this experiment, the more derating applied by the user, the less likely the probability of a surge failure occurring.

It must be remembered that these results were derived from a highly accelerated surge test machine, and failure rates in the low ppm are more likely with the end customer.

A commonly held misconception is that the leakage current of a Tantalum capacitor can predict the number of failures which will be seen on a surge screen. This can be disproved by the results of an experiment carried out at AVX on 47 μ F

Technical Summary and Application Guidelines

10V surface mount capacitors with different leakage currents. The results are summarized in the table below.

Leakage current vs number of surge failures.

Again, it must be remembered that these results were derived from a highly accelerated surge test machine, and failure rates in the low ppm are more likely with the end customer.

	Number tested	Number failed surge
Standard leakage range 0.1 μA to 1μA	10,000	25
Over Catalog limit 5μA to 50μA	10,000	26
Classified Short Circuit 50μA to 500μA	10,000	25

OxiCap® capacitor is less sensitive to an overloading stress compared to Tantalum and so a 20% minimum derating is recommended. It may be necessary in extreme low impedance circuits of high transient or ‘switch-on’ currents to derate the voltage further. Hence in general a lower voltage OxiCap® part number can be placed on a higher rail voltage compared to the tantalum capacitor – see table below.

AVX recommended derating table.

Voltage Rail (V)	Rated Voltage of Cap (V)	
	Tantalum	OxiCap®
3.3	6.3	4
5	10	6.3
8	16	10
10	20	–
12	25	–
15	35	–
>24	Series Combination	–

For further details on surge in Tantalum capacitors refer to J.A. Gill’s paper “Surge in Solid Tantalum Capacitors”, available from AVX offices worldwide.

An added bonus of increasing the derating applied in a circuit, to improve the ability of the capacitor to withstand surge conditions, is that the steady-state reliability is improved by up to an order. Consider the example of a 6.3 volt capacitor being used on a 5 volt rail.

The steady-state reliability of a Tantalum capacitor is affected by three parameters; temperature, series resistance and voltage derating. Assume 40°C operation and 0.1 Ohms/Volt series resistance.

The capacitors reliability will therefore be:

$$\begin{aligned}
 \text{Failure rate} &= F_U \times F_T \times F_R \times 1\%/1000 \text{ hours} \\
 &= 0.15 \times 0.1 \times 1 \times 1\%/1000 \text{ hours} \\
 &= 0.015\%/1000 \text{ hours}
 \end{aligned}$$

If a 10 volt capacitor was used instead, the new scaling factor would be 0.006, thus the steady-state reliability would be:

$$\begin{aligned}
 \text{Failure rate} &= F_U \times F_T \times F_R \times 1\%/1000 \text{ hours} \\
 &= 0.006 \times 0.1 \times 1 \times 1\%/1000 \text{ hours} \\
 &= 6 \times 10^{-4} \%/1000 \text{ hours}
 \end{aligned}$$

So there is an order improvement in the capacitors steady-state reliability.

Technical Summary and Application Guidelines



SECTION 4 RECOMMENDED SOLDERING CONDITIONS

Both Tantalum and OxiCap® are lead-free system compatible components, meeting requirements of J-STD-020 standard. The maximum conditions with care: Max. Peak Temperature: 260°C for maximum 10s, 3 reflow cycles. 2 cycles are allowed for F-series capacitors.

Small parametric shifts may be noted immediately after reflow, components should be allowed to stabilize at room temperature prior to electrical testing.

RECOMMENDED REFLOW PROFILE

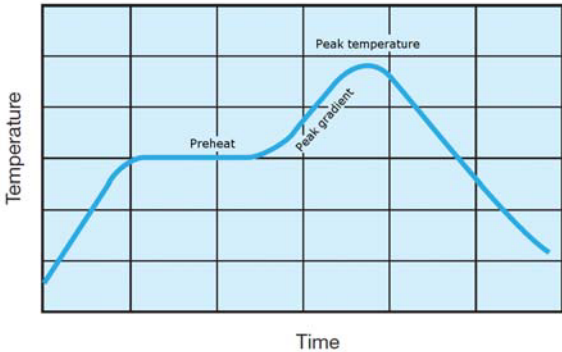

Lead-free soldering:

Pre-heating: 150±15°C/60–120sec.
Max. Peak Temperature: 245±5°C
Max. Peak Temperature Gradient: 2.5°C/sec.
Max. Time above 230°C: 40sec. max.

SnPb soldering:

Pre-heating: 150±15°C/60–90sec.
Max. Peak Temperature: 220±5°C
Max. Peak Temperature Gradient: 2°C/sec.
Max. Time above solder melting point: 60sec.

RECOMMENDED WAVE SOLDERING

Lead-free soldering:

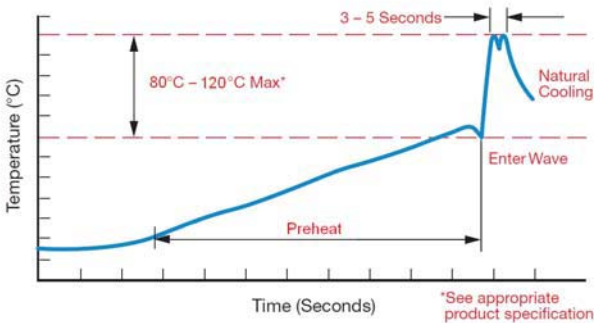

Pre-heating: 50-165°C/90-120sec.
Max. Peak Temperature: 250-260°C
Time of wave: 3-5sec.(max. 10sec.)

SnPb soldering:

Pre-heating: 50-165°C/90–120sec.
Max. Peak Temperature: 240-250°C
Time of wave: 3-5sec.(max.10sec.)

The upper side temperature of the board should not exceed +150°C.

GENERAL LEAD-FREE NOTES

The following should be noted by customers changing from lead based systems to the new lead free pastes.

- a) The visual standards used for evaluation of solder joints will need to be modified as lead-free joints are not as bright as with tin-lead pastes and the fillet may not be as large.
- b) Resin color may darken slightly due to the increase in temperature required for the new pastes.
- c) Lead-free solder pastes do not allow the same self alignment as lead containing systems. Standard mounting pads are acceptable, but machine set up may need to be modified.

Note: TCJ, TCM, TCN, J-CAP™, TCQ, TCR, F38, TLN and F98 series are not dedicated to wave soldering.

RECOMMENDED HAND SOLDERING

Recommended hand soldering condition:

Tip Diameter	Selected to fit Application
Max. Tip Temperature	+370°C
Max. Exposure Time	3s
Anti-static Protection	Non required

Note: TCJ, TCM, TCN, J-CAP™, TCQ, TCR, F38, TLN and F98 series are not dedicated to hand soldering.

SECTION 5 TERMINATIONS

5.1 Basic Materials

Two basic materials are used for termination leads: Nilo 42 (Fe58Ni42) and copper. Copper lead frame is mainly used for products requiring low ESR performance, while Nilo 42 is used for other products. The actual status of basic material per individual part type can be checked with AVX.

5.2 Termination Finishes – Coatings

Three terminations plating are available. Standard plating material is pure matte tin (Sn). Gold or tin-lead (SnPb) are available upon request with different part number suffix designations.*

5.2.1. Pure matte tin is used as the standard coating material meeting lead-free and RoHS requirements. AVX carefully monitors the latest findings on prevention of whisker formation. Currently used techniques include use of matte tin electrodeposition, nickel barrier underplating and recrystallization of surface by reflow. Terminations are tested for whiskers according to NEMI recommendations and JEDEC standard requirements. Data is available upon request.

5.2.2. Gold Plating is available as a special option* mainly for hybrid assembly using conductive glue.

5.2.3. Tin-lead (90%Sn 10%Pb) electroplated termination finish is available as a special option* upon request.

* Some plating options can be limited to specific part types. Please check availability of special options with AVX.

Technical Summary and Application Guidelines



SECTION 6 MECHANICAL AND THERMAL PROPERTIES OF CAPACITORS

6.1 Acceleration

98.1m/s² (10g)

6.2 Vibration Severity

10 to 2000Hz, 0.75mm of 98.1m/s² (10g)

6.3 Shock

Trapezoidal Pulse, 98.1m/s² for 6ms.

6.4 Adhesion to Substrate

IEC 384-3. minimum of 5N.

6.5 Resistance to Substrate Bending

The component has compliant leads which reduces the risk of stress on the capacitor due to substrate bending.

6.6 Soldering Conditions

Dip soldering is permissible provided the solder bath temperature is ≤ 270°C, the solder time < 3 seconds and the circuit board thickness ≥ 1.0mm.

6.7 Installation Instructions

The upper temperature limit (maximum capacitor surface temperature) must not be exceeded even under the most unfavorable conditions when the capacitor is installed. This must be considered particularly when it is positioned near components which radiate heat strongly (e.g. valves and power transistors). Furthermore, care must be taken, when bending the wires, that the bending forces do not strain the capacitor housing.

6.8 Installation Position

No restriction.

6.9 Soldering Instructions

Fluxes containing acids must not be used.

6.9.1 Guidelines for Surface Mount Footprints

Component footprint and reflow pad design for AVX capacitors.

The component footprint is defined as the maximum board area taken up by the terminators. The footprint dimensions are given by A, B, C and D in the diagram, which corresponds to W, max., A max., S min. and L max. for the component. The footprint is symmetric about the center lines.

The dimensions x, y and z should be kept to a minimum to reduce rotational tendencies while allowing for visual inspection of the component and its solder fillet.

Dimensions PS (c for F-series) (Pad Separation) and PW (a for F-series) (Pad Width) are calculated using dimensions x and z. Dimension y may vary, depending on whether reflow or wave soldering is to be performed.

For reflow soldering, dimensions PL (b for positive terminal of F-series; b' for negative terminal of F-series) (Pad Length), PW (a) (Pad Width), and PSL (Pad Set Length) have been calculated. For wave soldering the pad width (PWw) is reduced to less than the termination width to minimize the amount of solder pick up while ensuring that a good joint can be produced. In the case of mounting conformal coated capacitors, excentering (Δc) is needed to except anode tab [14].

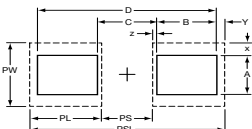

NOTE:

These recommendations (also in compliance with EIA) are guidelines only. With care and control, smaller footprints may be considered for reflow soldering.

Nominal footprint and pad dimensions for each case size are given in the following tables:

PAD DIMENSIONS: millimeters (inches)

Case Size	PSL	PL	PS	PW	PWw	
Series	A	4.00 (0.157)	1.40 (0.055)	1.20 (0.047)	1.80 (0.071)	0.90 (0.035)
SMD 'J' Lead & OxiCap® (excluding F-series)	B	4.00 (0.157)	1.40 (0.055)	1.20 (0.047)	2.80 (0.110)	1.60 (0.063)
	C	6.50 (0.256)	2.00 (0.079)	2.50 (0.098)	2.80 (0.110)	1.60 (0.063)
	D	8.00 (0.315)	2.00 (0.079)	4.00 (0.157)	3.00 (0.118)	1.70 (0.067)
	E	8.00 (0.315)	2.00 (0.079)	4.00 (0.157)	3.00 (0.118)	1.70 (0.067)
	F	6.50 (0.256)	2.00 (0.079)	2.50 (0.098)	2.80 (0.110)	1.60 (0.063)
	G	4.00 (0.157)	1.40 (0.055)	1.20 (0.047)	1.80 (0.071)	0.90 (0.035)
	H	4.00 (0.157)	1.40 (0.055)	1.20 (0.047)	2.80 (0.110)	1.60 (0.063)
	K	4.00 (0.157)	1.40 (0.055)	1.20 (0.047)	1.80 (0.071)	0.90 (0.035)
	L	4.00 (0.157)	1.40 (0.055)	1.20 (0.047)	2.80 (0.110)	1.60 (0.063)
	N	2.70 (0.106)	0.95 (0.037)	0.80 (0.031)	1.60 (0.063)	0.80 (0.031)
	P	2.70 (0.106)	0.95 (0.037)	0.80 (0.031)	1.60 (0.063)	0.80 (0.031)
	R	2.70 (0.106)	0.95 (0.037)	0.80 (0.031)	1.60 (0.063)	0.80 (0.031)
	S	4.00 (0.157)	1.40 (0.055)	1.20 (0.047)	1.80 (0.071)	0.90 (0.035)
	T	4.00 (0.157)	1.40 (0.055)	1.20 (0.047)	2.80 (0.110)	1.60 (0.063)
	U	8.00 (0.315)	2.00 (0.079)	4.00 (0.157)	3.70 (0.145)	1.80 (0.071)
	V	8.00 (0.315)	2.00 (0.079)	4.00 (0.157)	3.70 (0.145)	1.80 (0.071)
	W	6.50 (0.256)	2.00 (0.079)	2.50 (0.098)	2.80 (0.110)	1.60 (0.063)
	X	8.00 (0.315)	2.00 (0.079)	4.00 (0.157)	3.00 (0.118)	1.70 (0.067)
	Y	8.00 (0.315)	2.00 (0.079)	4.00 (0.157)	3.00 (0.118)	1.70 (0.067)
	Z	8.00 (0.315)	2.00 (0.079)	4.00 (0.157)	3.70 (0.145)	1.80 (0.071)
TACmicro-chip® Series	A	4.40 (0.173)	1.60 (0.063)	1.20 (0.047)	1.80 (0.071)	0.90 (0.035)
	B	4.70 (0.185)	1.70 (0.067)	1.30 (0.051)	3.00 (0.118)	1.50 (0.059)
	C	4.40 (0.173)	1.60 (0.063)	1.20 (0.047)	1.80 (0.071)	0.90 (0.035)
	D	4.40 (0.173)	1.60 (0.063)	1.20 (0.047)	1.80 (0.071)	0.90 (0.035)
	E	0.90 (0.035)	0.30 (0.012)	0.30 (0.012)	0.30 (0.012)	N/A
	H	3.20 (0.126)	1.30 (0.051)	0.60 (0.024)	1.50 (0.059)	0.075 (0.003)
	I	4.40 (0.173)	1.60 (0.063)	1.20 (0.047)	1.80 (0.071)	0.90 (0.035)
	J	2.80 (0.110)	1.10 (0.043)	0.60 (0.024)	1.00 (0.039)	0.50 (0.019)
	K	2.20 (0.087)	0.90 (0.035)	0.40 (0.016)	0.70 (0.028)	0.35 (0.014)
	L	2.80 (0.110)	1.10 (0.043)	0.60 (0.024)	1.00 (0.039)	0.50 (0.019)
	M	3.20 (0.126)	1.30 (0.051)	0.60 (0.024)	1.00 (0.039)	0.50 (0.019)
	Q	3.20 (0.126)	1.30 (0.051)	0.60 (0.024)	1.50 (0.059)	0.075 (0.003)
	R	3.20 (0.126)	1.30 (0.051)	0.60 (0.024)	1.50 (0.059)	0.075 (0.003)
	S	4.40 (0.173)	1.60 (0.063)	1.20 (0.047)	1.80 (0.071)	0.90 (0.035)
	T	4.70 (0.185)	1.70 (0.067)	1.30 (0.051)	3.00 (0.118)	1.50 (0.059)
	U	3.20 (0.126)	1.30 (0.051)	0.60 (0.024)	1.50 (0.059)	0.075 (0.003)
V	4.40 (0.173)	1.60 (0.063)	1.20 (0.047)	1.80 (0.071)	0.90 (0.035)	
Z	2.80 (0.110)	1.10 (0.043)	0.60 (0.024)	0.70 (0.028)	0.35 (0.014)	

Note: SMD 'J' Lead = TAJ, TMJ, TPS, TPM, TRJ, TRM, THJ, TLJ, TCJ, TCM, TCQ, TCR

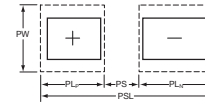

PAD DIMENSIONS: millimeters (inches)

Case Size	PSL	PL _p	PS	PL _N	PW+	PW-
Series	M	2.50 (0.098)	1.05 (0.041)	0.40 (0.016)	1.05 (0.041)	1.00 (0.039)
TLN, TCN & J-CAP™ Undertab	N	2.50 (0.098)	1.05 (0.041)	0.40 (0.016)	1.05 (0.041)	1.00 (0.039)
	K	3.60 (0.142)	1.35 (0.053)	0.90 (0.035)	1.35 (0.053)	1.30 (0.051)
	S	3.60 (0.142)	1.35 (0.053)	0.90 (0.035)	1.35 (0.053)	1.30 (0.051)
	L	3.90 (0.154)	1.35 (0.053)	1.00 (0.039)	1.55 (0.061)	2.50 (0.098)
	T	3.90 (0.154)	1.35 (0.053)	1.00 (0.039)	1.55 (0.061)	2.50 (0.098)
	H	3.90 (0.154)	1.35 (0.053)	1.00 (0.039)	1.55 (0.061)	2.50 (0.098)
	X	7.70 (0.303)	2.20 (0.087)	2.10 (0.083)	3.40 (0.134)	3.25 (0.128)
	3	7.70 (0.303)	2.20 (0.087)	2.10 (0.083)	3.40 (0.134)	4.75 (0.187)
	4	7.70 (0.303)	2.20 (0.087)	2.10 (0.083)	3.40 (0.134)	4.75 (0.187)
	6	15.20 (0.598)	2.65 (0.104)	9.90 (0.390)	2.65 (0.104)	5.50 (0.217)

PAD DIMENSIONS F-SERIES: millimeters (inches)

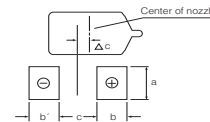

Case Size	a	b	b'	c	Δc*	
Series	U	0.35 (0.014)	0.40 (0.016)	0.40 (0.016)	0.40 (0.016)	0.00
F38, F91, F92, F93, F97, F98	M	0.65 (0.026)	0.70 (0.028)	0.70 (0.028)	0.60 (0.024)	0.00
	S	0.90 (0.035)	0.70 (0.028)	0.70 (0.028)	0.80 (0.032)	0.00
	P	1.00 (0.039)	1.10 (0.043)	1.10 (0.043)	0.40 (0.016)	0.00
	A	1.30 (0.051)	1.40 (0.055)	1.40 (0.055)	1.00 (0.039)	0.00
	B	2.30 (0.091)	1.40 (0.055)	1.40 (0.055)	1.30 (0.051)	0.00
	C	2.30 (0.091)	2.00 (0.079)	2.00 (0.079)	2.70 (0.106)	0.00
	N	2.50 (0.098)	2.00 (0.079)	2.00 (0.079)	4.00 (0.157)	0.00
F95, AUDIO F95 Conformal	R-P	1.40 (0.055)	0.60 (0.024)	0.50 (0.020)	0.70 (0.028)	0.20 (0.008)
	Q-S	1.70 (0.067)	0.70 (0.028)	0.60 (0.024)	1.10 (0.043)	0.20 (0.008)
	A	1.80 (0.071)	0.70 (0.028)	0.60 (0.024)	1.10 (0.043)	0.20 (0.008)
	T	2.60 (0.102)	0.70 (0.028)	0.60 (0.024)	1.20 (0.047)	0.20 (0.008)
F72 Conformal	R-M	5.80 (0.228)	1.20 (0.047)	1.20 (0.047)	3.90 (0.154)	0.50 (0.020)
	U-C	3.00 (0.118)	1.20 (0.047)	1.20 (0.047)	3.30 (0.130)	0.50 (0.020)
F75 Conformal	D	4.10 (0.161)	1.20 (0.047)	1.20 (0.047)	3.90 (0.154)	0.50 (0.020)
	R	5.80 (0.228)	1.20 (0.047)	1.20 (0.047)	3.90 (0.154)	0.50 (0.020)

*In the case of mounting conformal coated capacitors, excentering (Δc) is needed to except anode tab [14].

Technical Summary and Application Guidelines



PAD DIMENSIONS SMD HERMETIC:

millimeters (inches)

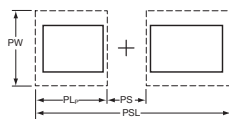

Case Size	PSL	PL	PS	PW	PW _w	
SERIES						
TCH & THH J-lead only	9	13.20 (0.520)	2.40 (0.094)	8.40 (0.331)	11.80 (0.465)	N/A
THH J-lead only	1	13.00 (0.512)	3.80 (0.150)	5.40 (0.213)	5.30 (0.210)	N/A
THH Undertab only	1	10.60 (0.417)	3.00 (0.118)	4.60 (0.181)	4.00 (0.157)	N/A

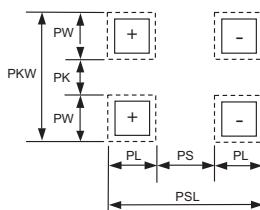

Case Size	PSL	PL	PS	PKW	PW	PK
SERIES						
TCH & THH Undertab only	9	11.00(0.433)	1.70(0.067)	7.60(0.300)	10.60(0.417)	3.00(0.118)

6.10 PCB Cleaning

Ta chip capacitors are compatible with most PCB board cleaning systems.

If aqueous cleaning is performed, parts must be allowed to dry prior to test. In the event ultrasonics are used power levels should be less than 10 watts per/litre, and care must be taken to avoid vibrational nodes in the cleaning bath.

SECTION 7: EPOXY FLAMMABILITY

EPOXY	UL RATING	OXYGEN INDEX
TAJ/TMJ/TPS/TPM/TRJ/TRM/THJ TLJ/TLN/TCJ/TCM/TCN/J-CAP™ TCQ/TCR/NLJ/NOJ/NOS/NOM	UL94 V-0	35%

SECTION 8: QUALIFICATION APPROVAL STATUS

DESCRIPTION	STYLE	SPECIFICATION
Surface mount capacitors	TAJ	CECC 30801 - 005 Issue 2 CECC 30801 - 011 Issue 1

Material Data and Handling

This should be read in conjunction with the Product Datasheet. Failure to observe the ratings and the information on this sheet may result in a safety hazard.

1. Material Content

Solid Tantalum and OxiCap® capacitors do not contain liquid hazardous materials.

The operating section contains:

Tantalum/Niobium	Graphite/carbon
Tantalum/Niobium oxide	Conducting paint/resins
Manganese dioxide	Fluoropolymers (not TAC)

The encapsulation contains:

TAC - epoxy molding compound, solder/tin coated terminal pads

TAJ, TMJ, TPS, TPM, TRJ, TRM, TLJ, TLN, TCJ, TCM, TCN, J-CAP™, TCQ, TCR, NLJ, NOJ, NOS and NOM - epoxy molding compound, tin/solder coated terminal pads

THJ - may contain Antimony trioxide and Bromide compounds as fire retardants.

TAP - solder, solder coated terminal wires, epoxy dipped resin

The capacitors do not contain PBB or PBBO/PBBE. The solder alloys may contain lead.

2. Physical Form

These capacitors are physically small and are either rectangular with solderable terminal pads, or cylindrical or bead shaped with solderable terminal wires.

3. Intrinsic Properties

Operating

Both Tantalum and OxiCap® capacitors are polarized devices and operate satisfactorily in the correct d.c. mode. They will withstand a limited application of reverse voltage as stated in the datasheets. However, a reverse application of the rated voltage will result in early short circuit failure and may result in fire or explosion. Consequential failure of other associated components in the circuit e.g. diodes, transformers, etc. may also occur. When operated in the correct polarity, a long period of satisfactory operation will be obtained but failure may occur for any of the following reasons:

- normal failure rate
- surge voltage exceeded
- reverse voltage exceeded
- temperature too high
- ripple rating exceeded

If this failure mode is a short circuit, the previous conditions apply. If the adjacent circuit impedance is low, voltage or current surges may exceed the power handling capability of the capacitor. For this reason capacitors in circuits of below 1Ω/V should be derated by minimum 50% for tantalum and 20% for OxiCap®. Precautions should be taken to prevent reverse voltage spikes. Where capacitors may be subjected to fast switched, low impedance source voltages, the manufacturers advice should be sought to determine the most suitable capacitors for such applications.

Non-operating

Both Tantalum and OxiCap® capacitors contain no liquids or noxious gases to leak out. However, cracking or damage to the encapsulation may lead to premature failure due to ingress of material such as cleaning fluids or to stresses transmitted to the tantalum anode.

4. Fire Characteristics

Primary

Any component subject to abnormal power dissipation may

- self ignite
- become red hot
- break open or explode emitting flaming or red hot material, solid, molten or gaseous.

Fumes from burning components will vary in composition depending on the temperature, and should be considered to be hazardous, although fumes from a single component in a well ventilated area are unlikely to cause problems.

Secondary

Induced ignition may occur from an adjacent burning or red hot component. Epoxy resins used in the manufacture of capacitors give off noxious fumes when burning as stated above. Wherever possible, capacitors comply with the following:

- BS EN 60065
- UL 492.60A/280
- LOI (ASTM D2863-70) as stated in the datasheets.

5. Storage

AVX Tantalum dielectric chip capacitors are unaffected by the following storage condition for 2 years:

- Temperature: -10°C – +50°C
- Humidity: 75% RH maximum
- Atmospheric pressure: 860 mbar ~ 1060mbar

Tantalum and OxiCap® capacitors exhibit a very low random failure rate after long periods of storage and apart from this there are no known modes of failure under normal storage conditions. All capacitors will withstand any environmental conditions within their ratings for the periods given in the detail specifications. Storage for longer periods under high humidity conditions may affect the leakage current of resin protected capacitors. Solderability of solder coated surfaces may be affected by storage of excess of 2 years. If F-series capacitors should be stored more than 1 year please contact AVX for advice.

6. Moisture Sensitivity Level

MSL is defined in J-STD-020. It is applicable to non-hermetic surface mount devices, and is focussed on parts in plastic packages.

The basic concept is that a plastic package may contain moisture, which can become a high pressure vapour during solder reflow. If this occurs, the vapor pressure may cause internal cracking or damage to the device. It can also result in external steam jets from the package, and these may displace other nearby components on the circuit board during the solder process. A common industry reference for this is "popcorning".

AVX solid tantalum and OxiCap® chips which are considered MSL 1 are molded in plastic packages, and are packaged in standard packaging, not including a moisture barrier unless dry pack MSL 3 special option is used (special character V in part number).

AVX solid electrolyte chips (standard tantalum, conductive polymer, OxiCap®), which are considered MSL 3, MSL 4 or MSL 5 (ref. product datasheet) are molded in plastic packages, and are distributed in packaging including a moisture barrier.

Material Data and Handling

AVX solid tantalum TACmicrochip® (TAC, TPC) are considered MSL 1 and supplied in packaging with a moisture barrier. TLC series is considered MSL 3 and is distributed in packaging including a moisture barrier.

7. Disposal

Incineration of epoxy coated capacitors will cause emission of noxious fumes and metal cased capacitors may explode due to build up of internal gas pressure. Disposal by any other means normally involves no special hazards. Large quantities may have salvage value.

8. Unsafe Use

Most failures are of a passive nature and do not represent a safety hazard. A hazard may, however, arise if this failure causes a dangerous malfunction of the equipment in which the capacitor is employed. Circuits should be designed to fail safe under the normal modes of failure. The usual failure mode is an increase in leakage current or short circuit. Other possible modes are decrease of capacitance, increase in dissipation factor (and impedance) or an open-circuit. Operations outside the ratings quoted in the datasheets represents unsafe use.

9. Handling

Careless handling of the cut terminal leads could result in scratches and/or skin punctures. Hands should be washed after handling solder coated terminals before eating or smoking, to avoid ingestion of lead. Capacitors must be kept out of the reach of small children. Care must be taken to discharge capacitors before handling as capacitors may retain a residual charge even after equipment in which they are being used has been switched off. Sparks from the discharge could ignite a flammable vapor.

Environmental Information

AVX has always sought to minimize the environmental impact of its manufacturing operations and of its capacitors supplied to customers throughout the world. We have a policy of preventing and minimizing waste streams during manufacture, and recycling materials wherever possible. We actively avoid or minimize environmentally hazardous materials in our production processes.

1. Material Content

For customers wishing to assess the environmental impact of AVX's capacitors contained in waste electrical and electronic equipment, the following information is provided:

Surface mount tantalum capacitors contain:

- Tantalum/Niobium and Tantalum/Niobium oxide
- Manganese dioxide
- Carbon/graphite
- Silver
- Tin/Tin-lead alloy plating
- Nickel-iron alloy or Copper alloy depending on design (consult factory for details)
- Polymers including fluorinated polymers
- Epoxide resin encapsulant

The encapsulant is made fire retardant to UL 94 V-0 by the inclusion of inert mineral filler and fire retardants.

2. Packaging Material

The component packing tape is recyclable Polycarbonate and the sealing tape is a laminate of halogen-free polymers. The reels are recyclable polystyrene, and marked with the recycling symbol. The reels are over-packed in recyclable fiber board boxes. None of the packing contains heavy metals.

3. Lead (Pb)

Parts supplied today are electroplated over the terminal contact area with 100% fused matte Tin (Sn). Parts with SnPb termination finish are available upon request only. Contact AVX for availability of parts with SnPb termination finish.

4. Fire Retardants

A combustible encapsulant free of antimony trioxide and organic bromide compound are supplied today. AVX believes that the health and safety benefits of using these materials to provide fire retardancy during the life of the product, far outweigh the possible risks to the environment and human health.

5. Nickel Alloy

It is intended that all case sizes will be made with a high copper alloy termination. Some case sizes are supplied now with this termination, and other sizes may be available. Please contact AVX if you prefer this.

6. Recycling

Surface mount Tantalum and OxiCap® capacitors have a very long service life with no known wear-out mechanism, and a low failure rate. However, parts contained in equipment which is of no further use will have some residual value mainly because of the Tantalum metal or niobium oxide contained. This can be recovered and recycled by specialist companies. The silver and nickel or copper alloy will also have some value. Please contact AVX if you require assistance with the disposal of parts. Packaging can be recycled as described above.

7. Disposal

Surface mount Tantalum and OxiCap® capacitors do not contain any liquids and no part of the devices is normally soluble in water at neutral pH values. Incineration will cause the emission of noxious fumes and is not recommended except by specialists. Landfill may be considered for disposal, bearing in mind the small lead content.

Under certain extreme physical conditions it is possible to generate ignition of Tantalum, Niobium and Niobium oxide capacitors. These physical conditions relate to high-speed impact and although not considered to be a normal operating occurrence may occur as a method of material(s) recovery. Therefore appropriate safeguards procedures and methodologies need to be adopted to eliminate any risks of material ignition.

For further information, please contact your local AVX sales office or representative.

8. Typical Weight by Case Sizes

The approximate content of some materials is given in the table below.

The specific weight of other materials contained in the various case sizes is available on written request.

Case Size	TAJ, TMJ TPS, TRJ TLJ, THJ	TPM TRM	TLN	TCJ TCQ TCR	TCM	TCN J-CAP™	NOJ NOS NLJ	NOM	TAC TLC TPC	F38	F72	F75	F91 F93 F97	F92	F95	F98	TCH	THH
Typical Weight (mg)																		
A	29			28			25		57.3				28	19	37			
B	68			72			57		83.6				65	36	68			
C	166			137			154					240	160					
D	290	298		278			265		14			400	300					
E	512	527		472	474		392	402	0.5									
F	148						109											
G	28			25			23											
H	52			51		51			15.2									
I									12									543
J									5.9									
K	17		22	15		20			2.8									
L			41			38			9									
M			10						11.3	5.7	330					6		
N	9		10	9		10							350					
P	15			15			12							9	18			
Q															20			
R	10			10					23.4		180	670			7			
S	19		27	18		25	17			12.4					25	13		
T	35		47	39		43	32		65.8						41			
U	738								8.5	1.2		160					1.6	
V	641	649		655	625		510		16.4									
W	99			100			82											
X	152			151		190	126											
Y	223	237		215			178											
Z									3.9									
3						251												
4			426			355												
5				429														
6			1056															
9																	2185	2210

Environmental Information

9. RoHS Compliance

9.1 Tantalum & Niobium Oxide Capacitors (excluding F-series)

AVX can declare that we do not add any materials from the list below to series TAJ, TMJ, TPS, TPM, TRJ, TRM, THJ, TLJ, TLN, TCJ, TCM, TCN, J-CAP™, TCQ, TCR, TAC, TLC, TPC, NLJ, NOJ, NOS and NOM during production, so they are not contained in any significant level.

9.2 F-Series Eco-Products “GeoCap”

AVX promotes environmentally conscious practices.

AVX offers “GeoCap”, which has completely lead free terminals and contains no polyvinyl chloride in the sleeve.

Substances		Taping Code	RoHS Compliance
Heavy Metals	Cadmium and cadmium compounds	All	YES
	Lead and lead compounds	A,B,Y,P	YES
		R,S,T,U	YES, since production date 1/1/04
	K,H	NO	
Mercury and mercury compounds	All	YES	
	Hexavalent chromium compounds	All	YES
Chlorinated organic compounds	Polychlorinated biphenyls (PCB)	All	YES
	Polychlorinated naphthalenes (PCN)	All	YES
	Chlorinated paraffins (CP)	All	YES
	Mirex (Perchlordecone)	All	YES
Brominated organic compounds	Polybrominated biphenyls (PBB)	All	YES
	Polybrominated diphenylethers (PBDE)	All	YES

F-SERIES TANTALUM CAPACITORS

Type - Classification		Series	Lead-Free Compliance	Anti Polyvinyl Chloride Compliance
Surface Mount type	Resin-Molded type	F38, F91, F92, F93, F97, F98	Complied	Complied
	Conformal Coated type	AUDIO F95, F95, F72, F75		

F-SERIES TANTALUM CAPACITORS CORRESPONDING TO RoHS DIRECTIVE

	Resin-Molded Chip F91/F92/F93/F97 Series	Conformal Coated Chip Audio F95/F95/F72/F75 Series	Facedown Terminal Resin-Molded Chip F98 Series	Conductive Polymer Facedown Terminal Resin-Molded Chip F38 Series
Compliance with RoHS Directive	Compliant	Compliant	Compliant	Compliant
Construction of Electrode Terminal	42 Alloy/ Ni/ Sn plating	Ni/ Sn-Cu solder	U Case Cu/ Ni/ Au/ Sn-3.5Ag plating M, S Case Cu/ Ni/ Au plating	Cu/ Ni/ Au plating
	Sn thickness 5µm Plating type matte No heat treatment after plating	Sn-Cu thickness 30µm (Solder dipping) No heat treatment after Solder dipping	U Case Sn-Ag thickness 5µm M, S Case Au thickness 0.05µm Plating type matte No heat treatment after plating	Au thickness 0.05µm Plating type matte No heat treatment after plating
Lead (Pb)	Does not contain	Does not contain	Does not contain	Does not contain
Chromium (VI)				
Mercury				
Cadmium				
PBB				
PBDE				
MSL (IPC/ JEDEC J-STD-020)	* LEVEL 1 to LEVEL 3 If you need detailed information about MSL LEVEL, please contact us.	LEVEL 3	LEVEL 3	LEVEL 3

Tantalum & Niobium Oxide Capacitors

(excluding F-series)

Tape & Reel Packaging

Tape and reel packaging for automatic component placement. Please enter required Suffix on order. Bulk packaging is not available.

TAPE SPECIFICATION

Tape dimensions comply to EIA 481-1 Dimensions A₀ and B₀ of the pocket and the tape thickness, K, are dependent on the component size. Tape materials do not affect component solderability during storage. Carrier Tape Thickness <0.4mm.

TAPING SUFFIX TABLE TAJ, TMJ, TPS, TPM, TRJ, TRM, THJ, TLJ, TLN TCJ, TCM, TCN, J-CAP™, TCQ, TCR, NLJ, NOJ, NOS, NOM

Case Size	Tape width mm	P mm	180mm (7") reel Tin Termination			330mm (13") reel Tin Termination			180mm (7") reel & Gold Termination	
			Suffix	Automotive Suffix	Qty.	Suffix	Automotive Suffix	Qty.	Suffix	Qty.
A	8	4	R	T	2,000	S	U	8,000	A	2,000
B	8	4	R	T	2,000	S	U	8,000	A	2,000
C	12	8	R	T	500	S	U	3,000	A	500
D	12	8	R	T	500	S	U	2,500	A	500
E	12	8	R	T	400	S	U	1,500	A	400
F	12	8	R	-	1,000	S	-	4,000	A	1,000
G	8	4	R	-	2,500	S	-	10,000	A	2,500
H	8	4	R	-	2,500	S	-	10,000	A	2,500
K	8	4	R	-	3,000	S	-	13,000	A	3,000
L	8	4	R	-	2,500	S	-	10,000	A	2,500
M	8	4	R	-	3,000	S	-	13,000	A	3,000
N	8	4	R	-	3,000	S	-	13,000	A	3,000
P	8	4	R	-	2,500	S	-	10,000	A	2,500
R	8	4	R	-	2,500	S	-	10,000	A	2,500
S	8	4	R	-	2,500	S	-	10,000	A	2,500
T	8	4	R	-	2,500	S	-	10,000	A	2,500
U	16	8	R	-	400	-	-	-	-	-
V	12	8	R	-	400	S	-	1,500	A	400
W	12	8	R	-	1,000	S	-	5,000	A	1,000
X	12	8	R	-	1,000	S	-	5,000	A	1,000
Y	12	8	R	-	1,000	S	-	4,000	A	1,000
Z	16	8	R	-	400	S	-	1,500	-	-
3	16	8	R	-	800	S	-	TBD	-	-
4	16	8	R	-	800	S	-	TBD	-	-
5	12	8	R	-	400	S	-	1,500	-	-
6	24	12	R	-	500	S	-	TBD	-	-

Under Development

TAPING SUFFIX TABLE TAC AND TLC

Case Size	Tape width mm	P mm	100mm (4") reel Tin Termination		180mm (7") reel Tin Termination		100mm (4") reel & Gold Termination		180mm (7") reel & 100% Gold Termination	
			Suffix	Qty.	Suffix	Qty.	Suffix	Qty.	Suffix	Qty.
A	8	4	XTA	500	RTA	2,000	FTA	500	ATA	2,000
B	8	4	XTA	500	RTA	2,500	FTA	500	ATA	2,500
C	8	4	XTA	500	RTA	3,500	-	-	-	-
D	8	4	XTA	500	RTA	2,500	-	-	-	-
H	8	4	XTA	500	RTA	3,500	FTA	500	ATA	3,500
I	8	4	XTA	500	RTA	2,500	FTA	500	ATA	2,500
J	8	4	XTA	500	RTA	3,500	FTA	500	ATA	3,500
K	8	2	QTA	1,000	PTA	10,000	NTA	1,000	MTA	10,000
L	8	4	XTA	500	RTA	3,500	FTA	500	ATA	3,500
M	8	4	XTA	500	RTA	2,500	FTA	500	ATA	2,500
N	8	2	QTA	1,000	PTA	10,000	-	-	-	-
Q	8	4	XTA	500	RTA	2,500	-	-	-	-
R	8	4	XTA	500	RTA	2,500	FTA	500	ATA	2,500
S	8	4	XTA	500	RTA	2,500	-	-	-	-
T	8	4	XTA	500	RTA	2,500	FTA	500	ATA	2,500
U	8	4	XTA	500	RTA	3,500	FTA	500	ATA	3,500
V	8	4	XTA	500	RTA	2,500	FTA	500	ATA	2,500
Z	8	2	QTA	1,000	PTA	10,000	-	-	-	-

Under Development

CHIP TRAY (WAFFLE) TABLE TLC

Case Size	Chip Tray Qty.	Tin Termination Suffix	Gold Termination Suffix
E	Each	HTA	-

Tantalum & Niobium Oxide Capacitors

(excluding F-series)

Tape & Reel Packaging

TAPING SUFFIX TABLE TPC

Case Size	Tape width mm	P mm	100mm (4") reel Tin Termination		180mm (7") reel Tin Termination		100mm (4") reel & Gold Termination		180mm (7") reel & 100% Gold Termination	
			Suffix	Qty.	Suffix	Qty.	Suffix	Qty.	Suffix	Qty.
H	8	4	Xxxxx	500	Rxxxx	3,500	Fxxxx	500	Axxxx	3,500
K	8	2	Qxxxx	1,000	Pxxxx	10,000	Nxxxx	1,000	Mxxxx	10,000
L	8	4	Xxxxx	500	Rxxxx	3,500	Fxxxx	500	Axxxx	3,500
R	8	4	Xxxxx	500	Rxxxx	2,500	Fxxxx	500	Axxxx	2,500

Note: xxxx = ESR value in Milliohms

TAPING SUFFIX TABLE TLC

Case Size	Tape width mm	P mm	100mm (4") reel Tin Termination		180mm (7") reel Tin Termination		100mm (4") reel & Gold Termination		180mm (7") reel & 100% Gold Termination	
			Suffix	Qty.	Suffix	Qty.	Suffix	Qty.	Suffix	Qty.
L	8	4	Xxxxx	500	Rxxxx	3,500	Fxxxx	500	Axxxx	3,500

Note: xxxx = ESR value in Milliohms

Tantalum & Niobium Oxide Capacitors

(excluding F-series)

Tape & Reel Packaging

PLASTIC TAPE DIMENSIONS TAJ, TMJ, TPS, TPM, TRJ, TRM, THJ, TLJ, TLN, TCJ, TCM, TCN, J-CAP™, TCQ, TCR, NLJ, NOJ, NOS AND NOM

Case	A0±0.10	B0±0.10	K±0.10	W±0.30	E±0.10	F±0.05	G min.	P±0.10	P2±0.05	P0±0.10	D ^{+0.20} _{-0.00}	D1 ^{+0.25} _{-0.00}
A	1.83	3.57	1.87	8.00	1.75	3.50	0.75	4.00	2.00	4.00	1.50	1.00
B	3.15	3.77	2.22	8.00	1.75	3.50	0.75	4.00	2.00	4.00	1.50	1.00
C	3.45	6.40	2.92	12.00	1.75	5.50	0.75	8.00	2.00	4.00	1.50	1.50
D	4.48	7.62	3.22	12.00	1.75	5.50	0.75	8.00	2.00	4.00	1.50	1.50
E	4.50	7.50	4.50	12.00	1.75	5.50	0.75	8.00	2.00	4.00	1.50	1.50
F	3.35	6.40	2.20	12.00	1.75	5.50	0.75	8.00	2.00	4.00	1.50	1.50
G	1.83	3.57	1.65	8.00	1.75	3.50	0.75	4.00	2.00	4.00	1.50	1.00
H	3.15	3.77	1.66	8.00	1.75	3.50	0.75	4.00	2.00	4.00	1.50	1.00
K	1.95	3.55	1.15	8.00	1.75	3.50	0.75	4.00	2.00	4.00	1.50	1.00
L	3.10	3.80	1.30	8.00	1.75	3.50	0.75	4.00	2.00	4.00	1.50	1.00
M	1.60	2.35	1.10	8.00	1.75	3.50	0.75	4.00	2.00	4.00	1.50	1.00
N	1.60	2.30	1.10	8.00	1.75	3.50	0.75	4.00	2.00	4.00	1.50	1.00
P	1.65	2.45	1.60	8.00	1.75	3.50	0.75	4.00	2.00	4.00	1.50	1.00
R	1.65	2.45	1.30	8.00	1.75	3.50	0.75	4.00	2.00	4.00	1.50	1.00
S	1.95	3.55	1.30	8.00	1.75	3.50	0.75	4.00	2.00	4.00	1.50	1.00
T	3.20	3.80	1.30	8.00	1.75	3.50	0.75	4.00	2.00	4.00	1.50	1.00
U	6.19	7.66	4.72	16.00	1.75	7.50	0.75	8.00	2.00	4.00	1.50	1.50
V	6.43	7.44	3.84	12.00	1.75	5.50	0.75	8.00	2.00	4.00	1.50	1.50
W	3.57	6.40	1.65	12.00	1.75	5.50	0.75	8.00	2.00	4.00	1.50	1.50
X	4.67	7.62	1.65	12.00	1.75	5.50	0.75	8.00	2.00	4.00	1.50	1.50
Y	4.67	7.62	2.15	12.00	1.75	5.50	0.75	8.00	2.00	4.00	1.50	1.50
3	6.25	7.88	2.25	16.00	1.75	7.50±0.1	0.75	8.00	2.00±0.1	4.00	1.50	1.50
4	6.25	7.88	2.25	16.00	1.75	7.50±0.1	0.75	8.00	2.00±0.1	4.00	1.50	1.50
5	4.50	7.50	4.50	12.00	1.75	5.50	0.75	8.00	2.00	4.00	1.50	1.50
6	8.55	15.60	2.25	24.00	1.75	11.50	0.75	12.00	2.00	4.00	1.50	1.50

PLASTIC TAPE DIMENSIONS TAC, TLC AND TPC

Case	A0±0.10	B0±0.10	K±0.10	W±0.30	E±0.10	F±0.05	G min.	P±0.10	P2±0.05	P0±0.10	D ^{+0.20} _{-0.00}	D1 ^{+0.20} _{-0.00}
A	1.83±0.10	3.57±0.10	1.87±0.10	8.00	1.75	3.50	0.75	4.00	2.00	4.00	1.50	1.00
B	3.15±0.10	3.77±0.10	1.66±0.10	8.00	1.75	3.50	0.75	4.00	2.00	4.00	1.50	1.00
C	1.95±0.10	3.55±0.10	1.15±0.10	8.00	1.75	3.50	0.75	4.00	2.00	4.00	1.50	1.00
D	1.95±0.10	3.60±0.10	0.90±0.10	8.00	1.75	3.50	0.75	4.00	2.00	4.00	1.50	1.00
H	1.65±0.10	2.45±0.10	1.10±0.05	8.00	1.75	3.50	0.75	4.00	2.00	4.00	1.50	1.00
I	1.95±0.10	3.60±0.10	0.90±0.10	8.00	1.75	3.50	0.75	4.00	2.00	4.00	1.50	1.00
J	1.05 ^{+0.10} _{-0.00}	1.90 ^{+0.10} _{-0.00}	0.80 ^{+0.10} _{-0.00}	8.00	1.75	3.50	0.75	4.00	2.00	4.00	1.50	0.80
K	0.75 ^{+0.05} _{-0.00}	1.26 ^{+0.10} _{-0.00}	0.67 ^{+0.10} _{-0.00}	8.00	1.75	3.50	0.75	2.00	2.00	2.00	1.50	0.50
L	1.05 ^{+0.10} _{-0.00}	1.90 ^{+0.10} _{-0.00}	1.05 ^{+0.10} _{-0.00}	8.00	1.75	3.50	0.75	4.00	2.00	4.00	1.50	0.80
M	1.05 ^{+0.10} _{-0.00}	2.45±0.10	1.05 ^{+0.10} _{-0.00}	8.00	1.75	3.50	0.75	4.00	2.00	4.00	1.50	0.80
Q	1.65±0.10	2.45±0.10	1.30±0.10	8.00	1.75	3.50	0.75	4.00	2.00	4.00	1.50	1.00
R	1.65±0.10	2.45±0.10	1.60±0.10	8.00	1.75	3.50	0.75	4.00	2.00	4.00	1.50	1.00
S	1.95±0.10	3.55±0.10	1.30±0.10	8.00	1.75	3.50	0.75	4.00	2.00	4.00	1.50	1.00
T	3.20±0.10	3.80±0.10	1.30±0.10	8.00	1.75	3.50	0.75	4.00	2.00	4.00	1.50	1.00
U	1.65±0.10	2.45±0.10	0.80±0.05	8.00	1.75	3.50	0.75	4.00	2.00	4.00	1.50	1.00
V	1.95±0.10	3.60±0.10	0.90±0.10	8.00	1.75	3.50	0.75	4.00	2.00	4.00	1.50	1.00
X	1.83±0.10	3.57±0.10	1.87±0.10	8.00	1.75	3.50	0.75	4.00	2.00	4.00	1.50	1.00
Z	0.75 ^{+0.05} _{-0.00}	1.90 ^{+0.10} _{-0.00}	0.67 ^{+0.10} _{-0.00}	8.00	1.75	3.50	0.75	2.00	2.00	2.00	1.50	0.50

Under development

CHIP TRAY DIMENSIONS

Case	X Pocket Size	Y Pocket Size	Z Pocket Depth	A Pocket Draft Angle	Array
E	0.76mm ±0.05mm	0.43mm ±0.05mm	0.41mm ±0.05mm	5° ±1/2°	20 x 20 (400)

Tantalum & Niobium Oxide Capacitors **AVX**

(excluding F-series)

Tape & Reel Packaging

REEL DIMENSIONS

Reel Size	Tape	A	B	C	W	t
180mm (7")	12mm	178±2.00	50 min	13.0±0.50	12.4+1.5/-0	1.50±0.50
180mm (7")	8mm	178±2.00	50 min	13.0±0.50	8.4+1.5/-0	1.50±0.50
330mm (13")	12mm	328±2.00	50 min	13.0±0.50	12.4+1.5/-0	1.50±0.50
330mm (13")	8mm	328±2.00	50 min	13.0±0.50	8.4+1.5/-0	1.50±0.50
108mm (4.25")	8mm	108±2.00		13.0±0.50	8.4+1.5/-0	1.50±0.50

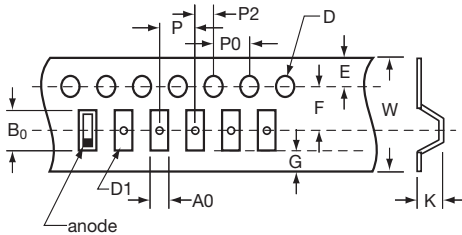
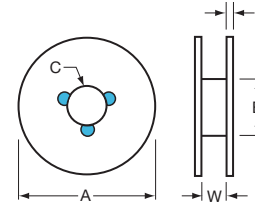

COVER TAPE NOMINAL DIMENSIONS

Thickness: 75µm
 Width of tape: 5.5mm (8mm tape)
 9.5mm (12mm tape)

TCH AND THH PACKAGING SPECIFICATION

The dimensions of the tray see in the figure below. Tolerance of dimensions are ±0.1 mm. Both case size "9" and "I" have 40 pcs per tray.

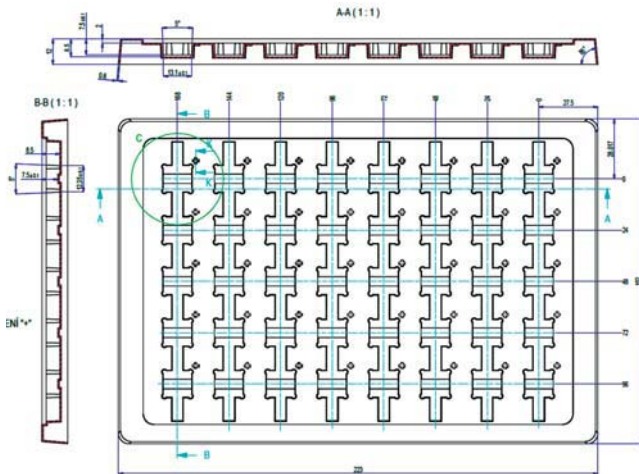

OVERALL CHIP TRAY SIZE

Size	Height	Flatness
50.80mm±0.10mm	3.96mm +0.05mm -0.08mm	0.10mm

PLASTIC CHIP TRAY

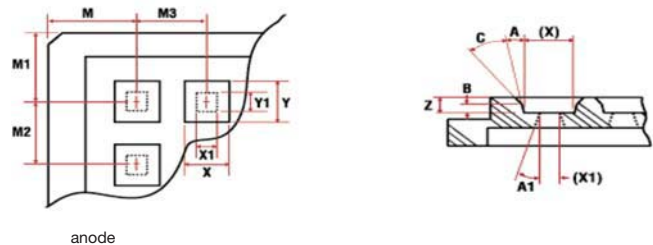

E Case

F-Series Tantalum Capacitors



Tape & Reel Packaging

TAPING QUANTITY TABLE – F-SERIES CAPACITORS

Series	Case Size	180mm (7") Reel	330mm (13") Reel
		Tin Termination Qty.	Tin Termination Qty.
F38, F98	U	10,000	–
	M, S	4,000	–
F92	P	3,000	8,000
	A, B	2,500	8,000
F91	A	2,000	8,000
F93	B	2,000	6,000
F97	C, N	500	2,500
F95 AUDIO F95	R, P	3,000	10,000
	Q, S, A, T	2,500	10,000
	B	2,000	8,500
F72	R	1,000	–
	M	500	–
F75	U, C, D, R	500	–

(*) : Export packaging. There are some differences between actual minimum quantity and above list. Please confirm before you order.

TYPE NUMBERING SYSTEM

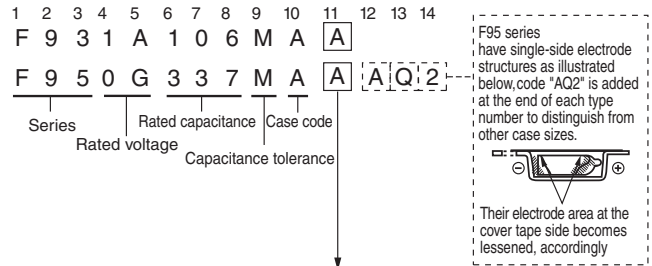

Tape Width (mm)	Polarity	Tape		Applicable Case Size		
		Reel Dia ϕ 180 mm	Reel Dia ϕ 330 mm	F91, F92 F93, F97 F98	F95 AUDIO F95	F72 F75
8	R (Anode is at opposite side of feeding holes)	A	E	U, M, S P, A, B	R, P, Q S, A, T B	–
12	R (Anode is at opposite side of feeding holes)	C	G	C, N	–	U, C D, R M

REEL DIMENSIONS (mm)

Item	Reel Diameter	
	180 ϕ	330 ϕ
A	$\phi 180^{+0.3}$	$\phi 330 \pm 2$

Item	Tape Width	
	8	12
W ₁	9.0 \pm 0.3	13 \pm 0.3
W ₂	11.4 \pm 1.0	15.4 \pm 1.0

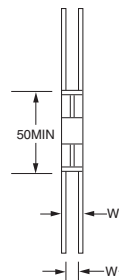
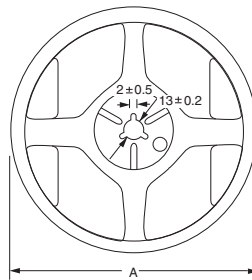

Note: The above shows the dimensions of ϕ 180 reel. In case of ϕ 330 reel, the appearance shape is slightly different.

CARRIER TAPE DIMENSIONS (mm)

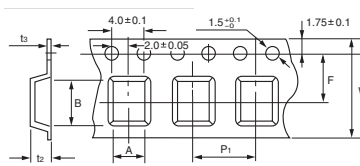

F91, F92, F93, F97, F98 M, F38 M

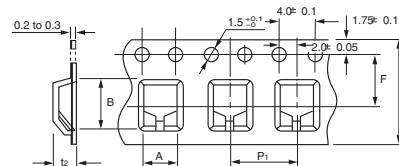

F95, AUDIO F95, F72, F75

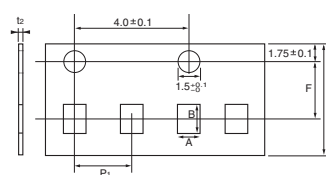

F98U

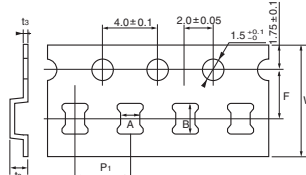

F98 S, F38 S

Case Code	W	A	B	F	P ₁	t ₂	t ₃
U	8.0 \pm 0.3	0.73 \pm 0.08	1.20 \pm 0.05	3.5 \pm 0.05	2.0 \pm 0.1	0.7 Max.	–
M		0.97 \pm 0.05	1.85 \pm 0.05			1.3 Max.	
S		1.35 \pm 0.1	2.15 \pm 0.1			1.4 Max.	
P		1.55 \pm 0.1	2.3 \pm 0.1	(1.7 Max.)			
A		1.9 \pm 0.1	3.5 \pm 0.1	2.1 Max. (1.7)			
B	12.0 \pm 0.3	3.3 \pm 0.1	3.8 \pm 0.1	5.5 \pm 0.05	8.0 \pm 0.1	2.4 Max. (1.7)	0.2 to 0.3
C		3.6 \pm 0.1	6.3 \pm 0.1			2.9 Max.	
N		4.8 \pm 0.1	7.7 \pm 0.1			3.5 Max.	

Type	Case Code	W	A	B	F	P ₁	t ₂	
F95 AUDIO F95	R	8.0 \pm 0.3	1.5 \pm 0.2	2.6 \pm 0.2	3.5 \pm 0.05	4.0 \pm 0.1	1.05 Max.	
	P			1.5 Max.				
	Q, S			2.0 \pm 0.2			3.6 \pm 0.2	1.5 Max.
	A			2.1 \pm 0.2			3.7 \pm 0.2	2.0 Max.
	T			3.0 \pm 0.2			3.75 \pm 0.2	1.5 Max.
F72	B	3.25 \pm 0.2	3.7 \pm 0.2	2.4 Max.				
	R	6.5 \pm 0.2	7.6 \pm 0.2	2.2 Max.				
F75	M	12.0 \pm 0.3	3.7 \pm 0.2	7.6 \pm 0.2	5.5 \pm 0.1	8.0 \pm 0.1	2.5 Max.	
	U			6.6 \pm 0.2			7.8 \pm 0.2	2.7 Max.
	C			4.8 \pm 0.2			7.9 \pm 0.2	3.6 Max.
	D			6.7 \pm 0.2			7.6 \pm 0.2	3.9 Max.
	R			4.6 Max.				

TAP/TEP Technical Summary and Application Guidelines



SECTION 1: ELECTRICAL CHARACTERISTICS AND EXPLANATION OF TERMS

1.1 CAPACITANCE

1.1.1 Rated capacitance (C_R)

This is the nominal rated capacitance. For tantalum capacitors it is measured as the capacitance of the equivalent series circuit at 20°C in a measuring bridge supplied by a 120 Hz source free of harmonics with 2.2V DC bias max.

1.1.2 Temperature dependence on the capacitance

The capacitance of a tantalum capacitor varies with temperature. This variation itself is dependent to a small extent on the rated voltage and capacitor size. See graph below for typical capacitance changes with temperature.

Typical Capacitance vs. Temperature

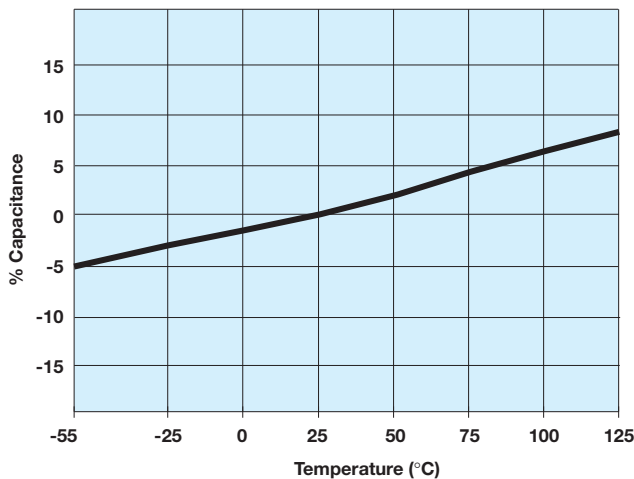

1.1.3 Capacitance tolerance

This is the permissible variation of the actual value of the capacitance from the rated value.

1.1.4 Frequency dependence of the capacitance

The effective capacitance decreases as frequency increases. Beyond 100 kHz the capacitance continues to drop until resonance is reached (typically between 0.5-5 MHz depending on the rating). Beyond this the device becomes inductive.

Typical Curve Capacitance vs. Frequency

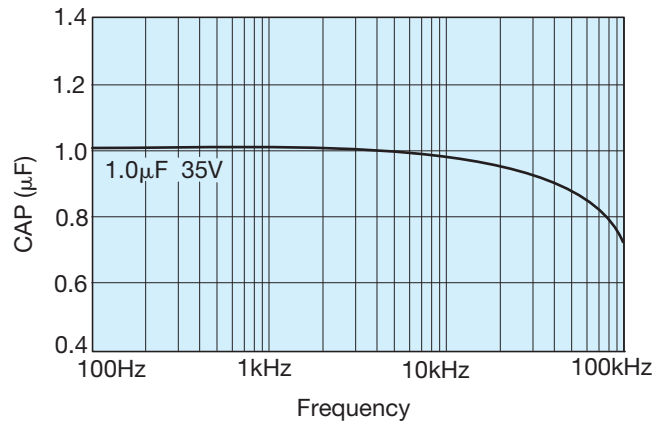

1.2 VOLTAGE

1.2.1 Rated DC voltage (V_R)

This is the rated DC voltage for continuous operation up to +85°C.

1.2.2 Category voltage (V_C)

This is the maximum voltage that may be applied continuously to a capacitor. It is equal to the rated voltage up to +85°C, beyond which it is subject to a linear derating, to 2/3 V_R at 125°C.

1.2.3 Surge voltage (V_S)

This is the highest voltage that may be applied to a capacitor for short periods of time. The surge voltage may be applied up to 10 times in an hour for periods of up to 30 seconds at a time. The surge voltage must not be used as a parameter in the design of circuits in which, in the normal course of operation, the capacitor is periodically charged and discharged.

Category Voltage vs. Temperature

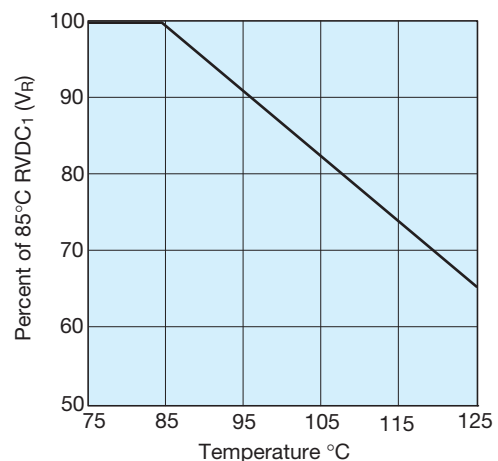

TAP/TEP Technical Summary and Application Guidelines



85°C		125°C	
Rated Voltage (V DC)	Surge Voltage (V DC)	Category Voltage (V DC)	Surge Voltage (V DC)
2	2.6	1.3	1.7
3	4	2	2.6
4	5.2	2.6	3.4
6.3	8	4	5
10	13	6.3	9
16	20	10	12
20	26	13	16
25	33	16	21
35	46	23	28
50	65	33	40

1.2.4 Effect of surges

The solid Tantalum capacitor has a limited ability to withstand surges (15% to 30% of rated voltage). This is in common with all other electrolytic capacitors and is due to the fact that they operate under very high electrical stress within the oxide layer. In the case of 'solid' electrolytic capacitors this is further complicated by the limited self healing ability of the manganese dioxide semiconductor.

It is important to ensure that the voltage across the terminals of the capacitor does not exceed the surge voltage rating at any time. This is particularly so in low impedance circuits where the capacitor is likely to be subjected to the full impact of surges, especially in low inductance applications. Even an extremely short duration spike is likely to cause damage. In such situations it will be necessary to use a higher voltage rating.

1.3 DISSIPATION FACTOR AND TANGENT OF LOSS ANGLE (TAN D)

1.3.1 Dissipation factor (DF)

Dissipation factor is the measurement of the tangent of the loss angle ($\tan \delta$) expressed as a percentage.

The measurement of DF is carried out at +25°C and 120 Hz with 2.2V DC bias max. with an AC voltage free of harmonics. The value of DF is temperature and frequency dependent.

1.3.2 Tangent of loss angle ($\tan \delta$)

This is a measure of the energy loss in the capacitor. It is expressed as $\tan \delta$ and is the power loss of the capacitor divided by its reactive power at a sinusoidal voltage of specified frequency. (Terms also used are power factor, loss factor and dielectric loss, $\cos(90 - \delta)$ is the true power factor.) The measurement of $\tan \delta$ is carried out at +20°C and 120 Hz with 2.2V DC bias max. with an AC voltage free of harmonics.

1.2.5 Reverse voltage and non-polar operation

The reverse voltage ratings are designed to cover exceptional conditions of small level excursions into incorrect polarity. The values quoted are not intended to cover continuous reverse operation.

The peak reverse voltage applied to the capacitor must not exceed:

10% of rated DC working voltage to a maximum of 1V at 25°C

3% of rated DC working voltage to a maximum of 0.5V at 85°C

1% of category DC working voltage to a maximum of 0.1V at 125°C

1.2.6 Non-polar operation

If the higher reverse voltages are essential, then two capacitors, each of twice the required capacitance and of equal tolerance and rated voltage, should be connected in a back-to-back configuration, i.e., both anodes or both cathodes joined together. This is necessary in order to avoid a reduction in life expectancy.

1.2.7 Superimposed AC voltage (V_{rms}) - Ripple Voltage

This is the maximum RMS alternating voltage, superimposed on a DC voltage, that may be applied to a capacitor. The sum of the DC voltage and the surge value of the superimposed AC voltage must not exceed the category voltage, V_C . Full details are given in Section 2.

1.2.8 Voltage derating

Refer to section 3.2 (pages 229-232) for the effect of voltage derating on reliability.

1.3.3 Frequency dependence of dissipation factor

Dissipation Factor increases with frequency as shown in the typical curves below.

Typical Curve-Dissipation Factor vs. Frequency

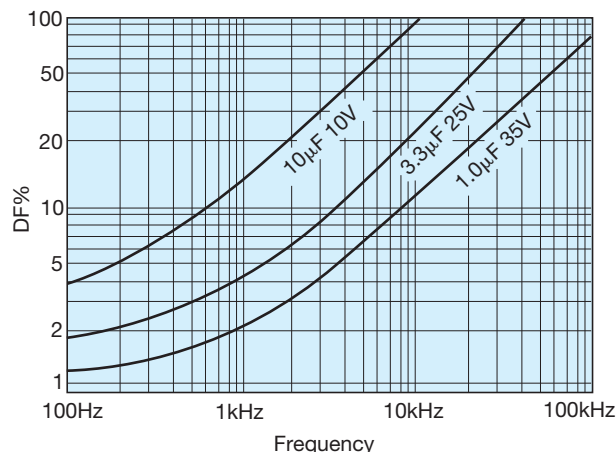

TAP/TEP Technical Summary and Application Guidelines



1.3.4 Temperature dependence of dissipation factor

Dissipation factor varies with temperature as the typical curves show to the right. For maximum limits please refer to ratings tables.

Typical Curves-Dissipation Factor vs. Temperature

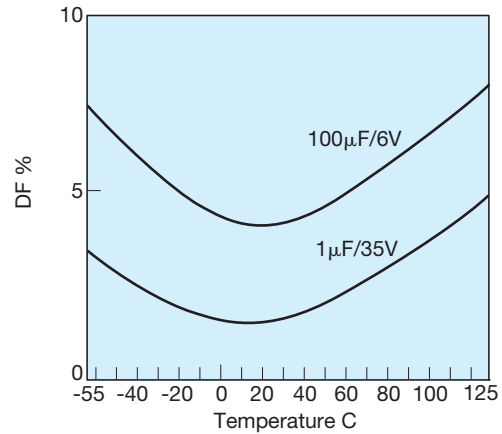

1.4 IMPEDANCE, (Z) AND EQUIVALENT SERIES RESISTANCE (ESR)

1.4.1 Impedance, Z

This is the ratio of voltage to current at a specified frequency. Three factors contribute to the impedance of a tantalum capacitor; the resistance of the semiconducting layer, the capacitance, and the inductance of the electrodes and leads.

At high frequencies the inductance of the leads becomes a limiting factor. The temperature and frequency behavior of these three factors of impedance determine the behavior of the impedance Z. The impedance is measured at 25°C and 100 kHz.

1.4.2 Equivalent series resistance, ESR

Resistance losses occur in all practical forms of capacitors. These are made up from several different mechanisms, including resistance in components and contacts, viscous forces within the dielectric, and defects producing bypass current paths. To express the effect of these losses they are considered as the ESR of the capacitor. The ESR is frequency dependent. The ESR can be found by using the relationship:

$$ESR = \frac{\tan \delta}{2\pi f C}$$

where f is the frequency in Hz, and C is the capacitance in farads. The ESR is measured at 25°C and 100 kHz.

ESR is one of the contributing factors to impedance, and at high frequencies (100 kHz and above) is the dominant factor, so that ESR and impedance become almost identical, impedance being marginally higher.

1.4.3 Frequency dependence of impedance and ESR

ESR and impedance both increase with decreasing frequency. At lower frequencies the values diverge as the extra contributions to impedance (resistance of the semiconducting layer, etc.) become more significant. Beyond 1 MHz (and beyond the resonant point of the capacitor) impedance again increases due to induction.

Frequency Dependence of Impedance and ESR

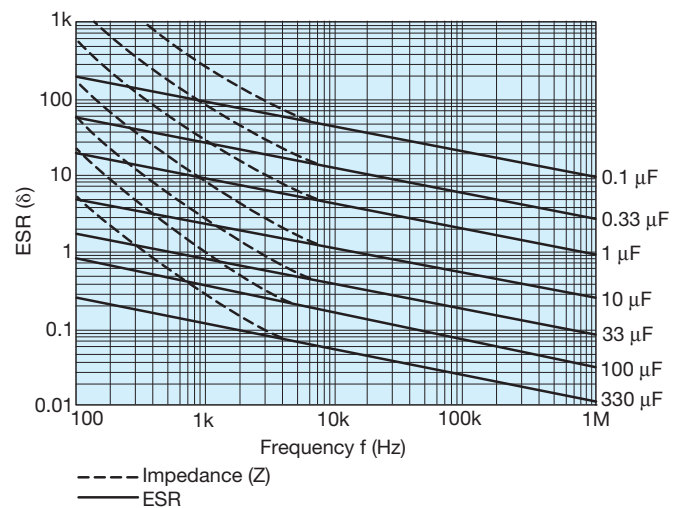

TAP/TEP Technical Summary and Application Guidelines



1.4.4 Temperature dependence of the impedance and ESR

At 100 kHz, impedance and ESR behave identically and decrease with increasing temperature as the typical curves show. For maximum limits at high and low temperatures, please refer to graph opposite.

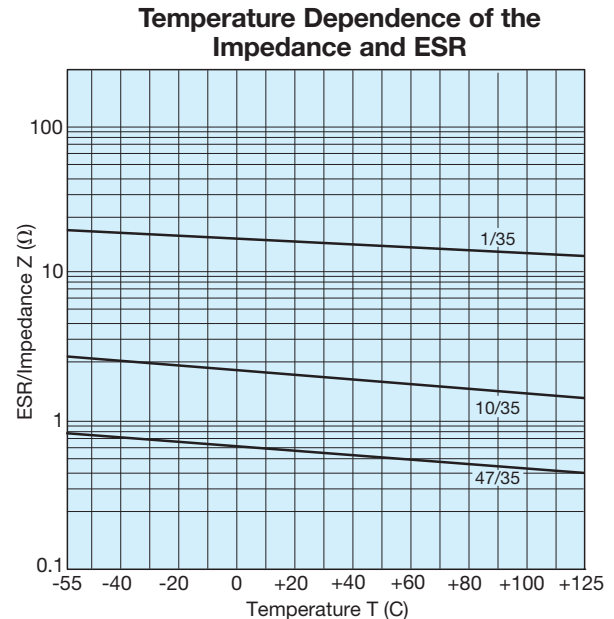

1.5 DC LEAKAGE CURRENT (DCL)

1.5.1 Leakage current (DCL)

The leakage current is dependent on the voltage applied, the time, and the capacitor temperature. It is measured at +25°C with the rated voltage applied. A protective resistance of 1000Ω is connected in series with the capacitor in the measuring circuit.

Three minutes after application of the rated voltage the leakage current must not exceed the maximum values indicated in the ratings table. Reforming is unnecessary even after prolonged periods without the application of voltage.

1.5.2 Temperature dependence of the leakage current

The leakage current increases with higher temperatures, typical values are shown in the graph.

For operation between 85°C and 125°C, the maximum working voltage must be derated and can be found from the following formula.

$$V_{\max} = \left(1 - \frac{T-85}{120}\right) \times V_R \text{ volts}$$

where T is the required operating temperature. Maximum limits are given in rating tables.

1.5.3 Voltage dependence of the leakage current

The leakage current drops rapidly below the value corresponding to the rated voltage V_R when reduced voltages are applied. The effect of voltage derating on the leakage current is shown in the graph.

This will also give a significant increase in reliability for any application. See Section 3 (pages 226-231) for details.

1.5.4 Ripple current

The maximum ripple current allowance can be calculated from the power dissipation limits for a given temperature rise above ambient. Please refer to Section 2 (page 232) for details.

Temperature Dependence of the Leakage Current for a Typical Component

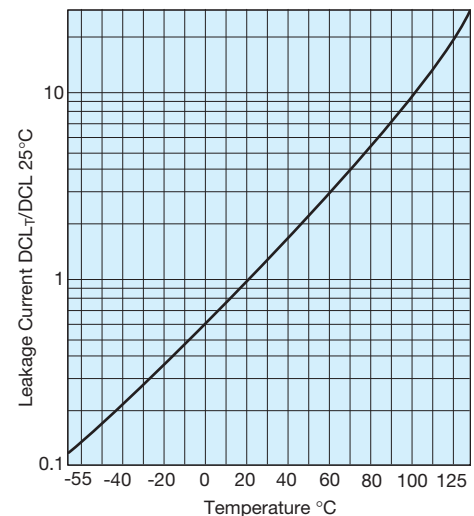

Effect of Voltage Derating on Leakage Current

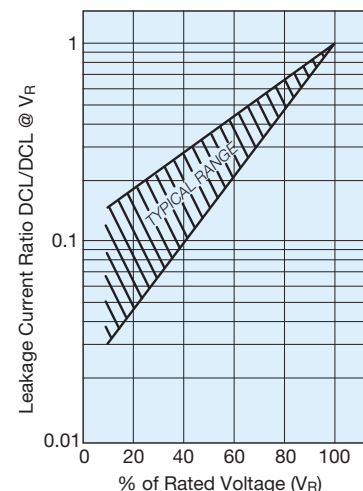

TAP/TEP Technical Summary and Application Guidelines



SECTION 2: AC OPERATION — RIPPLE VOLTAGE AND RIPPLE CURRENT

2.1 RIPPLE RATINGS (AC)

In an AC application heat is generated within the capacitor by both the AC component of the signal (which will depend upon signal form, amplitude and frequency), and by the DC leakage. For practical purposes the second factor is insignificant. The actual power dissipated in the capacitor is calculated using the formula:

$$P = I^2 R = \frac{E^2 R}{Z^2}$$

- I = rms ripple current, amperes
- R = equivalent series resistance, ohms
- E = rms ripple voltage, volts
- P = power dissipated, watts
- Z = impedance, ohms, at frequency under consideration

Using this formula it is possible to calculate the maximum AC ripple current and voltage permissible for a particular application.

2.2 MAXIMUM AC RIPPLE VOLTAGE (E_{MAX})

From the previous equation:

$$E_{(max)} = Z \sqrt{\frac{P_{max}}{R}}$$

where P_{max} is the maximum permissible ripple voltage as listed for the product under consideration (see table).

However, care must be taken to ensure that:

1. The DC working voltage of the capacitor must not be exceeded by the sum of the positive peak of the applied AC voltage and the DC bias voltage.
2. The sum of the applied DC bias voltage and the negative peak of the AC voltage must not allow a voltage reversal in excess of that defined in the sector, 'Reverse Voltage'.

2.3 MAXIMUM PERMISSIBLE POWER DISSIPATION (WATTS) @ 25°C

The maximum power dissipation at 25°C has been calculated for the various series and are shown in Section 2.4, together with temperature derating factors up to 125°C.

For leaded components the values are calculated for parts supported in air by their leads (free space dissipation).

The ripple ratings are set by defining the maximum temperature rise to be allowed under worst case conditions, i.e., with resistive losses at their maximum limit. This differential is normally 10°C at room temperature dropping to 2°C at 125°C. In application circuit layout, thermal management, available ventilation, and signal waveform may significantly

affect the values quoted below. It is recommended that temperature measurements are made on devices during operating conditions to ensure that the temperature differential between the device and the ambient temperature is less than 10°C up to 85°C and less than 2°C between 85°C and 125°C. Derating factors for temperatures above 25°C are also shown below. The maximum permissible proven dissipation should be multiplied by the appropriate derating factor.

For certain applications, e.g., power supply filtering, it may be desirable to obtain a screened level of ESR to enable higher ripple currents to be handled. Please contact our applications desk for information.

2.4 POWER DISSIPATION RATINGS (IN FREE AIR)

TAR – Molded Axial

Case size	Max. power dissipation (W)	Temperature derating factors	
		Temp. °C	Factor
Q	0.065	+25	1.0
R	0.075	+85	0.6
S	0.09	+125	0.4
W	0.105		

TAA – Hermetically Sealed Axial

Case size	Max. power dissipation (W)	Temperature derating factors	
		Temp. °C	Factor
A	0.09	+20	1.0
B	0.10	+85	0.9
C	0.125	+125	0.4
D	0.18		

TAP/TEP – Resin Dipped Radial

Case size	Max. power dissipation (W)	Temperature derating factors	
		Temp. °C	Factor
A	0.045	+25	1.0
B	0.05	+85	0.4
C	0.055	+125	0.09
D	0.06		
E	0.065		
F	0.075		
G	0.08		
H	0.085		
J	0.09		
K	0.1		
L	0.11		
M/N	0.12		
P	0.13		
R	0.14		



TAP/TEP Technical Summary and Application Guidelines



SECTION 3: RELIABILITY AND CALCULATION OF FAILURE RATE

3.1 STEADY-STATE

Tantalum Dielectric has essentially no wear out mechanism and in certain circumstances is capable of limited self healing, random failures can occur in operation. The failure rate of Tantalum capacitors will decrease with time and not increase as with other electrolytic capacitors and other electronic components.

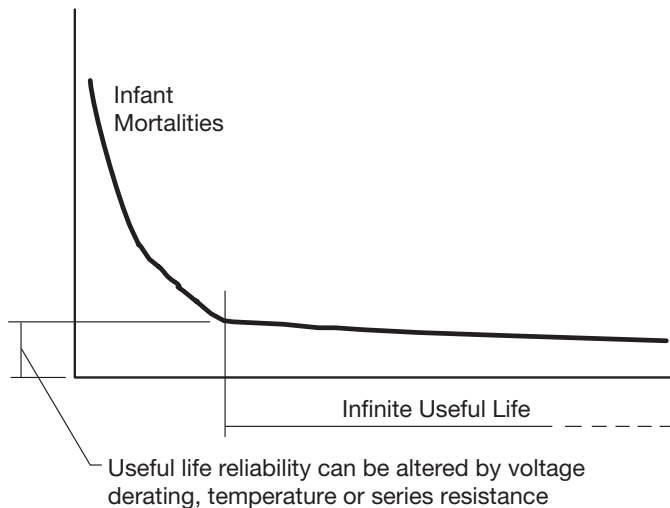

Figure 1. Tantalum reliability curve.

The useful life reliability of the Tantalum capacitor is affected by three factors. The equation from which the failure rate can be calculated is:

$$F = F_U \times F_T \times F_R \times F_B$$

where F_U is a correction factor due to operating voltage/voltage derating

F_T is a correction factor due to operating temperature

F_R is a correction factor due to circuit series resistance

F_B is the basic failure rate level. For standard leaded Tantalum product this is 1%/1000hours

Operating voltage/voltage derating

If a capacitor with a higher voltage rating than the maximum line voltage is used, then the operating reliability will be improved. This is known as voltage derating. The graph, Figure 2, shows the relationship between voltage derating (the ratio between applied and rated voltage) and the failure rate. The graph gives the correction factor F_U for any operating voltage.

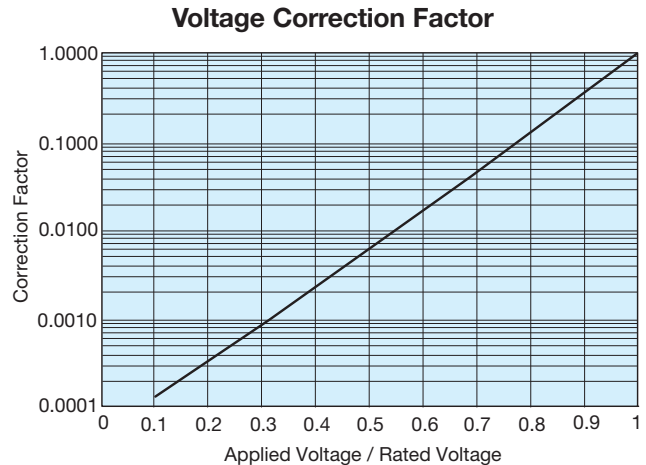

Figure 2. Correction factor to failure rate F for voltage derating of a typical component (60% con. level).

Operating temperature

If the operating temperature is below the rated temperature for the capacitor then the operating reliability will be improved as shown in Figure 3. This graph gives a correction factor F_T for any temperature of operation.

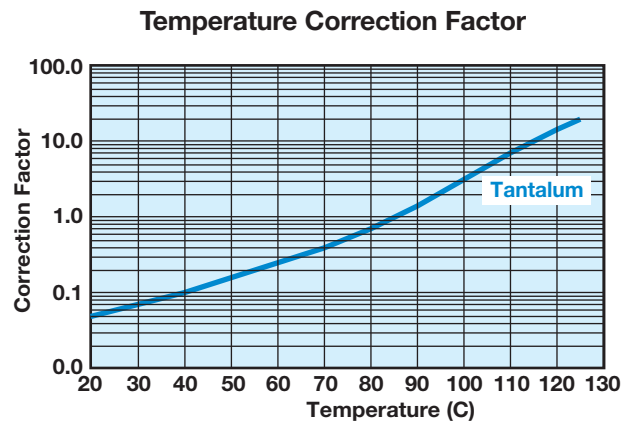

Figure 3. Correction factor to failure rate F for ambient temperature T for typical component (60% con. level).

TAP/TEP Technical Summary and Application Guidelines



Circuit Impedance

All solid tantalum capacitors require current limiting resistance to protect the dielectric from surges. A series resistor is recommended for this purpose. A lower circuit impedance may cause an increase in failure rate, especially at temperatures higher than 20°C. An inductive low impedance circuit may apply voltage surges to the capacitor and similarly a non-inductive circuit may apply current surges to the capacitor, causing localized over-heating and failure. The recommended impedance is 1Ω per volt. Where this is not feasible, equivalent voltage derating should be used (See MIL HANDBOOK 217E). Table I shows the correction factor, F_R , for increasing series resistance.

Table I: Circuit Impedance

Correction factor to failure rate F for series resistance R on basic failure rate F_B for a typical component (60% con. level).

Circuit Resistance ohms/volt	FR
3.0	0.07
2.0	0.1
1.0	0.2
0.8	0.3
0.6	0.4
0.4	0.6
0.2	0.8
0.1	1.0

Example calculation

Consider a 12 volt power line. The designer needs about 10μF of capacitance to act as a decoupling capacitor near a video bandwidth amplifier. Thus the circuit impedance will be limited only by the output impedance of the boards power unit and the track resistance. Let us assume it to be about 2 Ohms minimum, i.e., 0.167 Ohms/Volt. The operating temperature range is -25°C to +85°C. If a 10μF 16 Volt capacitor was designed-in, the operating failure rate would be as follows:

- a) $F_T = 0.8 @ 85^\circ\text{C}$
- b) $F_R = 0.7 @ 0.167 \text{ Ohms/Volt}$
- c) $F_U = 0.17 @ \text{applied voltage/rated voltage} = 75\%$

Thus $F_B = 0.8 \times 0.7 \times 0.17 \times 1 = 0.0952\%/1000 \text{ Hours}$

If the capacitor was changed for a 20 volt capacitor, the operating failure rate will change as shown.

$F_U = 0.05 @ \text{applied voltage/rated voltage} = 60\%$

$F_B = 0.8 \times 0.7 \times 0.05 \times 1 = 0.028\%/1000 \text{ Hours}$

3.2 DYNAMIC

As stated in Section 1.2.4 (page 230), the solid Tantalum capacitor has a limited ability to withstand voltage and current surges. Such current surges can cause a capacitor to fail. The expected failure rate cannot be calculated by a simple formula as in the case of steady-state reliability. The two parameters under the control of the circuit design engineer known to reduce the incidence of failures are derating and series resistance. The table below summarizes the results of trials carried out at AVX with a piece of equipment which has very low series resistance and applied no derating. So that the capacitor was tested at its rated voltage.

Results of production scale derating experiment

Capacitance and Voltage	Number of units tested	50% derating applied	No derating applied
47μF 16V	1,547,587	0.03%	1.1%
100μF 10V	632,876	0.01%	0.5%
22μF 25V	2,256,258	0.05%	0.3%

As can clearly be seen from the results of this experiment, the more derating applied by the user, the less likely the probability of a surge failure occurring.

It must be remembered that these results were derived from a highly accelerated surge test machine, and failure rates in the low ppm are more likely with the end customer.

TAP/TEP Technical Summary and Application Guidelines



A commonly held misconception is that the leakage current of a Tantalum capacitor can predict the number of failures which will be seen on a surge screen. This can be disproved by the results of an experiment carried out at AVX on 47µF 10V surface mount capacitors with different leakage currents. The results are summarized in the table below.

Leakage Current vs Number of Surge Failures

	Number tested	Number failed surge
Standard leakage range 0.1 µA to 1µA	10,000	25
Over Catalog limit 5µA to 50µA	10,000	26
Classified Short Circuit 50µA to 500µA	10,000	25

Again, it must be remembered that these results were derived from a highly accelerated surge test machine, and failure rates in the low ppm are more likely with the end customer.

AVX recommended derating table

Voltage Rail	Working Cap Voltage
3.3	6.3
5	10
10	20
12	25
15	35
≥24	Series Combinations (11)

For further details on surge in Tantalum capacitors refer to J.A. Gill's paper "Surge in Solid Tantalum Capacitors", available from AVX offices worldwide.

An added bonus of increasing the derating applied in a circuit, to improve the ability of the capacitor to withstand surge conditions, is that the steady-state reliability is improved by up to an order. Consider the example of a 6.3 volt capacitor being used on a 5 volt rail. The steady-state reliability of a Tantalum capacitor is affected by three parameters; temperature, series resistance and voltage derating. Assuming 40°C operation and 0.1Ω/volt of series resistance, the scaling factors for temperature and series resistance will both be 0.05 [see Section 3.1 (page 234)]. The derating factor will be 0.15. The capacitors reliability will therefore be

$$\begin{aligned} \text{Failure rate} &= F_U \times F_T \times F_R \times 1\%/1000 \text{ hours} \\ &= 0.15 \times 0.05 \times 1 \times 1\%/1000 \text{ hours} \\ &= 7.5\% \times 10^{-3}/\text{hours} \end{aligned}$$

If a 10 volt capacitor was used instead, the new scaling factor would be 0.017, thus the steady-state reliability would be

$$\begin{aligned} \text{Failure rate} &= F_U \times F_T \times F_R \times 1\%/1000 \text{ hours} \\ &= 0.017 \times 0.05 \times 1 \times 1\%/1000 \text{ hours} \\ &= 8.5\% \times 10^{-4}/1000 \text{ hours} \end{aligned}$$

So there is an order improvement in the capacitors steady-state reliability.

3.3 RELIABILITY TESTING

AVX performs extensive life testing on tantalum capacitors.

- 2,000 hour tests as part of our regular Quality Assurance Program.

Test conditions:

- 85°C/rated voltage/circuit impedance of 3Ω max.
- 125°C/0.67 x rated voltage/circuit impedance of 3Ω max.

3.4 Mode of Failure

This is normally an increase in leakage current which ultimately becomes a short circuit.

TAP/TEP Technical Summary and Application Guidelines



SECTION 4: APPLICATION GUIDELINES FOR TANTALUM CAPACITORS

4.1 SOLDERING CONDITIONS AND BOARD ATTACHMENT

The soldering temperature and time should be the minimum for a good connection.

A suitable combination for wavesoldering is 230°C - 250°C for 3 - 5 seconds.

Small parametric shifts may be noted immediately after wave solder, components should be allowed to stabilize at room temperature prior to electrical testing.

AVX leaded tantalum capacitors are designed for wave soldering operations.

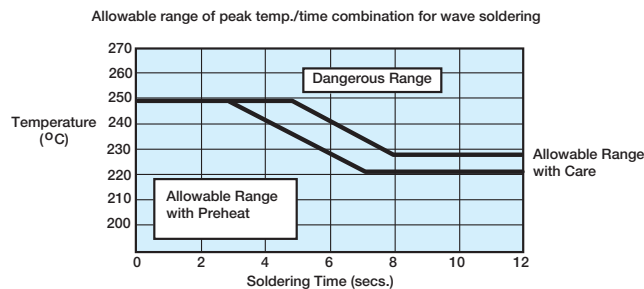

4.2 RECOMMENDED SOLDERING PROFILES

Recommended wave soldering profile for mounting of tantalum capacitors is shown below.

After soldering the assembly should preferably be allowed to cool naturally. In the event that assisted cooling is used, the rate of change in temperature should not exceed that used in reflow.

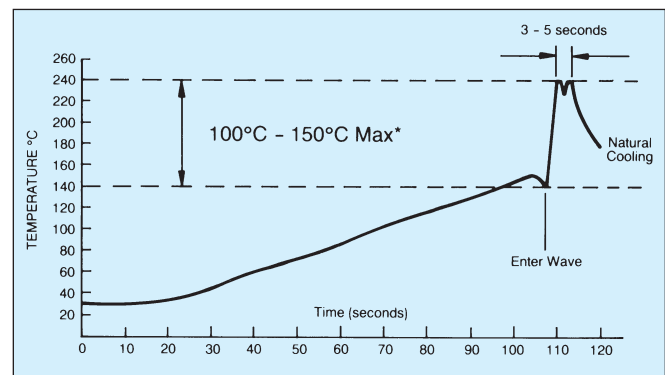

*See appropriate product specification

SECTION 5: MECHANICAL AND THERMAL PROPERTIES, LEADED CAPACITORS

5.1 ACCELERATION

10 g (981 m/s)

5.2 VIBRATION SEVERITY

10 to 2000 Hz, 0.75 mm or 98 m/s²

5.3 SHOCK

Trapezoidal Pulse 10 g (981 m/s) for 6 ms

5.4 TENSILE STRENGTH OF CONNECTION

10 N for type TAR, 5 N for type TAP/TEP.

5.5 BENDING STRENGTH OF CONNECTIONS

2 bends at 90°C with 50% of the tensile strength test loading.

5.6 SOLDERING CONDITIONS

Dip soldering permissible provided solder bath temperature $\leq 270^\circ\text{C}$; solder time < 3 sec.; circuit board thickness ≤ 1.0 mm.

5.7 INSTALLATION INSTRUCTIONS

The upper temperature limit (maximum capacitor surface temperature) must not be exceeded even under the most unfavorable conditions when the capacitor is installed. This must be considered particularly when it is positioned near components which radiate heat strongly (e.g., valves and power transistors). Furthermore, care must be taken, when bending the wires, that the bending forces do not strain the capacitor housing.

5.8 INSTALLATION POSITION

No restriction.

5.9 SOLDERING INSTRUCTIONS

Fluxes containing acids must not be used.



Technical Summary and Application Guidelines

QUESTIONS AND ANSWERS

Some commonly asked questions regarding Tantalum Capacitors:

Question: If I use several tantalum capacitors in serial/parallel combinations, how can I ensure equal current and voltage sharing?

Answer: Connecting two or more capacitors in series and parallel combinations allows almost any value and rating to be constructed for use in an application. For example, a capacitance of more than 60µF is required in a circuit for stable operation. The working voltage rail is 24 Volts dc with a superimposed ripple of 1.5 Volts at 120 Hz. The maximum voltage seen by the capacitor is $V_{dc} + V_{ac}=25.5V$

Applying the 50% derate rule tells us that a 50V capacitor is required.

Connecting two 25V rated capacitors in series will give the required capacitance voltage rating, but the effective capacitance will be halved, so for greater than

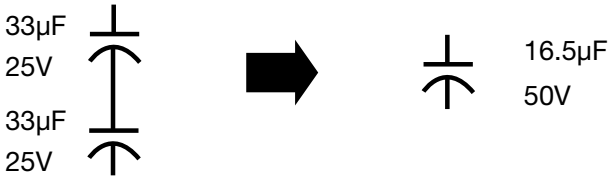

60µF, four such series combinations are required, as shown.

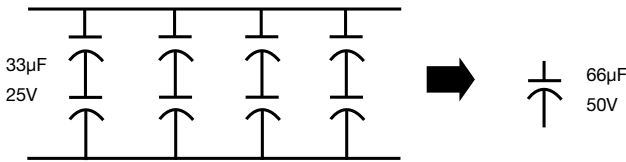

In order to ensure reliable operation, the capacitors should be connected as shown below to allow current sharing of the ac noise and ripple signals. This prevents any one capacitor heating more than its neighbors and thus being the weak link in the chain.

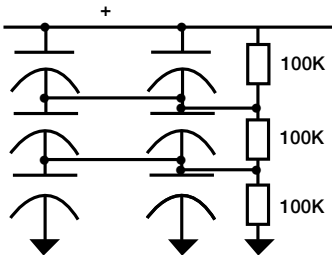

The two resistors are used to ensure that the leakage currents of the capacitors does not affect the circuit reliability, by ensuring that all the capacitors have half the working voltage across them.

Question: What are the advantages of tantalum over other capacitor technologies?

Answer:

1. Tantalums have high volumetric efficiency.
2. Electrical performance over temperature is very stable.
3. They have a wide operating temperature range -55 degrees C to +125 degrees C.
4. They have better frequency characteristics than aluminum electrolytics.
5. No wear out mechanism. Because of their construction, solid tantalum capacitors do not degrade in performance or reliability over time.

Question: If the part is rated as a 25 volt part and you have current surged it, why can't I use it at 25 volts in a low impedance circuit?

Answer: The high volumetric efficiency obtained using tantalum technology is accomplished by using an extremely thin film of tantalum pentoxide as the dielectric. Even an application of the relatively low voltage of 25 volts will produce a large field strength as seen by the dielectric. As a result of this, derating has a significant impact on reliability as described under the reliability section. The following example uses a 22 microfarad capacitor rated at 25 volts to illustrate the point. The equation for determining the amount of surface area for a capacitor is as follows:

$$C = (\epsilon (E_o) (A)) / d$$

$$A = (C (d)) / (\epsilon_o \epsilon)$$

$$A = ((22 \times 10^{-6}) (170 \times 10^{-9})) / ((8.85 \times 10^{-12}) (27))$$

$$A = 0.015 \text{ square meters (150 square centimeters)}$$

Where C = Capacitance in farads

- A = Dielectric (Electrode) Surface Area (m²)
- d = Dielectric thickness (Space between dielectric) (m)
- ε = Dielectric constant (27 for tantalum)
- ε° = Dielectric Constant relative to a vacuum (8.855 x 10⁻¹² Farads x m⁻¹)

To compute the field voltage potential felt by the dielectric we use the following logic.

$$\text{Dielectric formation potential} = \text{Formation Ratio} \times \text{Working Voltage}$$

$$= 4 \times 25$$

$$\text{Formation Potential} = 100 \text{ volts}$$

Dielectric (Ta₂O₅) Thickness (d) is 1.7 x 10⁻⁹ Meters Per Volt
 $d = 0.17 \mu \text{ meters}$

$$\text{Electric Field Strength} = \text{Working Voltage} / d$$

$$= (25 / 0.17 \mu \text{ meters})$$

$$= 147 \text{ Kilovolts per millimeter}$$

$$= 147 \text{ Megavolts per meter}$$

Technical Summary and Application Guidelines

QUESTIONS AND ANSWERS

No matter how pure the raw tantalum powder or the precision of processing, there will always be impurity sites in the dielectric. We attempt to stress these sites in the factory with overvoltage surges, and elevated temperature burn in so that components will fail in the factory and not in your product. Unfortunately, within this large area of tantalum pentoxide, impurity sites will exist in all capacitors. To minimize the possibility of providing enough activation energy for these impurity sites to turn from an amorphous state to a crystalline state that will conduct energy, series resistance and derating is recommended. By reducing the electric field within the anode at these sites, the tantalum capacitor has increased reliability. Tantalums differ from other electrolytics in that charge transients are carried by electronic conduction rather than absorption of ions.

Question: What negative transients can Solid Tantalum Capacitors operate under?

Answer: The reverse voltage ratings are designed to cover exceptional conditions of small level excursions into incorrect polarity. The values quoted are not intended to cover continuous reverse operation. The peak reverse voltage applied to the capacitor must not exceed:

- 10% of rated DC working voltage to a maximum of 1 volt at 25°C.
- 3% of rated DC working voltage to a maximum of 0.5 volt at 85°C.
- 1% of category DC working voltage to a maximum of 0.1 volt at 125°C.

Question: I have read that manufacturers recommend a series resistance of 0.1 ohm per working volt. You suggest we use 1 ohm per volt in a low impedance circuit. Why?

Answer: We are talking about two very different sets of circuit conditions for those recommendations. The 0.1 ohm per volt recommendation is for steady-state conditions. This level of resistance is used as a basis for the series resistance variable in a 1% / 1000 hours 60% confidence level reference. This is what steady-state life tests are based on. The 1 ohm per volt is recommended for dynamic conditions which include current in-rush applications such as inputs to power supply circuits. In many power supply topologies where the di/dt through the capacitor(s) is limited, (such as most implementations of buck (current mode), forward converter, and flyback), the requirement for series resistance is decreased.

Question: How long is the shelf life for a tantalum capacitor?

Answer: Solid tantalum capacitors have no limitation on shelf life. The dielectric is stable and no reformation is required. The only factors that affect future performance of the capacitors would be high humidity conditions and extreme storage temperatures. Solderability of solder coated surfaces may be affected by storage in excess of 2 years. Recommended storage conditions are: Temperature between -10°C – +50°C with humidity 75% RH maximum and atmospheric pressure 860 mbar-1060 mbar. Terminations should be checked for solderability in the event an oxidation develops on the solder plating.

Question: Are any recommendations/limitation for capacitor selection in parallel combination of capacitors?

Answer: Higher performance series TPS, TPM, NOS, NOM, TCJ, TCN are designed to provide lower ESR values and make the product more robust against current surges. The design differences make the better performance distribution of parameters, namely ESR is lower and tighter compared to the general purpose TAJ series. The surge current load in a parallel combination of capacitors is therefore shared more evenly amongst the capacitors and thus it is better suited for this application.

In a parallel combination is is strongly recommended to use the low ESR series of Tantalum Capacitors such as TPS, TPM, NOS, NOM, TCJ and TCN. Do not combine different series of manufacturers within one parallel combination.

Question: What level of voltage derating is needed for Tantalum Capacitors?

Answer: For many years whenever people have asked a tantalum capacitor manufacturer about what were the safe guidelines for using their product, they spoke with one voice “a minimum of 50% voltage derating should be applied”. This message has since become ingrained and automatic. This article challenges this statement and explains why it is not necessarily the case.

The 50% rule came about when tantalum capacitors started to be used on low impedance sources. In such applications, the available current is high and therefore a risk of failure is inherent. Well established by empirical methods and covered in MIL-STD 317, was the fact that the amount of voltage derating has a major influence on the failure rate of a tantalum capacitor (Figure 1). Indeed, from rated voltage to 50% of rated voltage is an improvement in failure rate of more than 100.

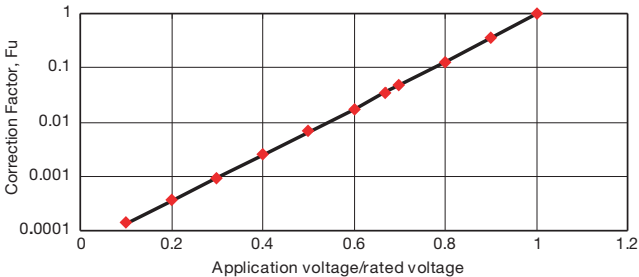
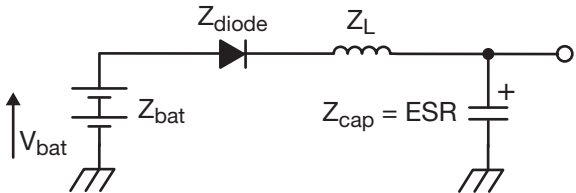

Figure 1

It was also proved that the same was true of dynamic, high current pulse conditions', hence the recommendation.

Now let us look more closely at the type of circuits in use. Below is a simple circuit which will be discussed further in this text.



Technical Summary and Application Guidelines

Let us assume this is a 2 cell battery system, therefore
 $V_{\text{bat}} = 3.2 \text{ Volts}$

Also, let us assume

$Z_{\text{bat}} = 60 \text{ m}\Omega$, $Z_{\text{diode}} = 70 \text{ m}\Omega$, $Z_{\text{cap}} = 120 \text{ m}\Omega$, $Z_L = 70 \text{ m}\Omega$

If the "50% rule" was followed, the designer should chose a 6.3V rated capacitor.

The total circuit impedance of the system is 320 mΩ. So by Ohm's law the peak current would be 10 Amps.

This exceeds the test conditions used by AVX to screen its product for high current pulses¹, so a risk of failure exists. Clearly a minimum of a 10 volt rate capacitor is required in this application.

As a general rule of thumb, the maximum current a tantalum capacitor can withstand (provided it has not been damaged by thermomechanical damage^{2 3} or some other external influence) is given by the equation:

$$I_{\text{max}} = V_{\text{rated}} / (1 + \text{Catalog ESR})$$

So for example for a 100μF 10V D case capacitor (Catalog ESR = 0.9 Ohms), this would be:

$$I_{\text{max}} = 10 / (1 + 0.9) = 5.2 \text{ Amps}$$

In some circuits, because of size restrictions, a tantalum capacitor may be the only option available. If this is the case, AVX recommends a PFET integrator be used to slow the voltage ramp at turn on, which in effect reduces the peak current, and therefore reduces the risk of failure⁴.

Now, let's consider a continuation of the circuit with the addition of an LDO or DC/DC convertor.

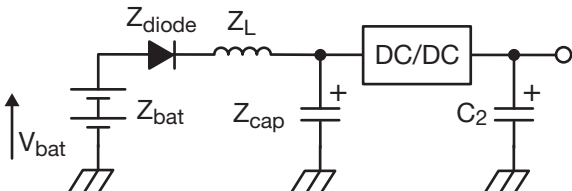

The risk of a high surge current being seen by the capacitor in location C₂ is very small. Therefore if we assume the voltage rail is 2.8 volts and the maximum current seen by C₂ is <1.5 Amps, a 4 volt capacitor could be able to be used in this application.

This all seems like good news, but as always, there are some downsides to using a part nearer to its rated voltage. The first is the steady-state life, or MTBF. The MTBF of a tantalum capacitor is easily calculated from MIL-STD 317 or the supplier's catalog data. An example is given below:

Assume operating temperature is 85°C and circuit impedance 0.1 Ohms/volt ($F_T = 1$).

For a 10 volt rated capacitor on a 5 volt rated line, the failure rate is:

$$\begin{aligned} F_R &= 1\%/1000 \text{ hours} \times F_T \times F_U \times F_R \\ &= 1\%/1000 \text{ hours} \times 1 \times 0.007 \text{ (from Figure 1)} \times 1 \\ &= 0.007\%/1000 \text{ hours} \end{aligned}$$

$$\begin{aligned} \text{MTBF} &= 10^5 / F_R \\ &= 14,285,238 \text{ hours} \\ &= 1,631 \text{ years} \end{aligned}$$

For a 6.3 volt rated capacitor on a 5 volt rated line, the failure rate is:

$$\begin{aligned} F_R &= 1\%/1000 \text{ hours} \times F_T \times F_U \times F_R \\ &= 1\%/1000 \text{ hours} \times 1 \times 0.12 \text{ (from Figure 1)} \times 1 \\ &= 0.12\%/1000 \text{ hours} \end{aligned}$$

$$\begin{aligned} \text{MTBF} &= 10^5 / F_R \\ &= 833,333 \text{ hours} \\ &= 95 \text{ years} \end{aligned}$$

The second factor to be considered is that the more derating applied to a tantalum capacitor, the lower the leakage current level (Figure 2). Therefore a part used at 50% of its rated voltage will have more than 3 times better leakage levels than one used at 80%.

Leakage Current vs. Rated Voltage

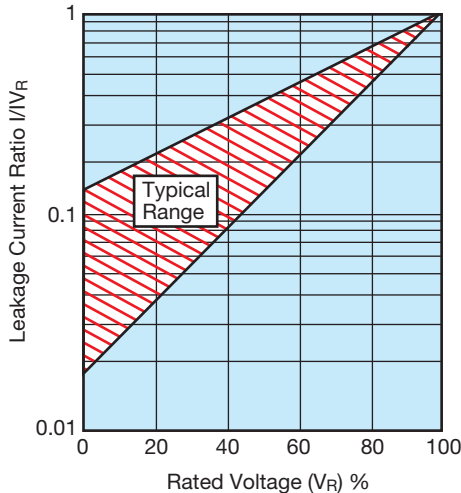

Figure 2

One final point worthy of mention with the introduction of higher reflow temperatures with the introduction of lead-free solders is that voltage derating can help to reduce the risk of failures due to thermomechanical damage during reflow.

To summarize, a tantalum capacitor is capable of being used at its rated voltage or close to it, provided that the user obeys the rules outlined in this document and is prepared for the reduced steady-state life performance and higher leakage current levels this would produce.

¹ Surge in Solid Tantalum Capacitors, John Gill, AVX Tantalum
² IR Reflow Guidelines for Tantalum Capacitors, Steve Warden & John Gill, AVX Tantalum
³ Mounting Guidelines in AVX Tantalum Catalog
⁴ Improving Reliability of Tantalum Capacitors in Low Impedance Circuits, Dave Mattingly, AVX

Technical Summary and Application Guidelines



Question: What does failure rate mean?

Answer: Failure rate is expressed as the number of parts (as a percentage) that can be expected to fail in a given time period under specific conditions of temperature, applied voltage (ratio to rated voltage - usually 1.0) and circuit impedance.

Question: What does ppm mean?

Answer: PPM is defined as 'PARTS PER MILLION' and can be used to express how many parts within a million pieces may fail to the specification.

Question: What is the difference between %/1000hrs and FITs?

Answer: The failure rate as the mathematic quantity can be expressed in several units of measurement - mostly in %/1000hrs or in FITs. FITs are usually used for the high-reliability components where expression in %/1000hrs would be more difficult to read. The conversion is as follows: e.g. 0.01%/1000hrs = 100 FIT for specified conditions ($[\%/1000\text{hrs}] = x 10000 [\text{FIT}]$).

Question: What are the standards for reliability calculations?

Answer: The standards used in the AVX specification are based on the European norm EN 61709 with the added feature of series resistance in order to better reflect real application conditions. The basic failure rate in the AVX test is given for conditions - 85°C, Vrated, 0.1 Ohm/V. To calculate the actual failure rate for specific conditions you have to consider the influence of different factors which have an impact on reliability - correction factors for temperature (FT), voltage derating (FV), (circuit) impedance (FR) and the base failure rate (Fbase) for the series being used.

Question: Are tantalum capacitors ESD (i.e. Electrostatic Discharge) sensitive devices?

Answer: All tantalum and niobium Oxide capacitors are not ESD sensitive devices.

SpiTan IV

Contains typical measured data for the majority of AVX solid electrolytic capacitors and gives an overview of typical performance characteristic for tantalum and niobium oxide capacitors at different frequencies and temperatures. SpiTanIV does not contain the data from specification.

INPUT PARAMETERS

- Selected PN from the list with the help of filter (technology, capacitance, rated voltage, case, series, tolerance)

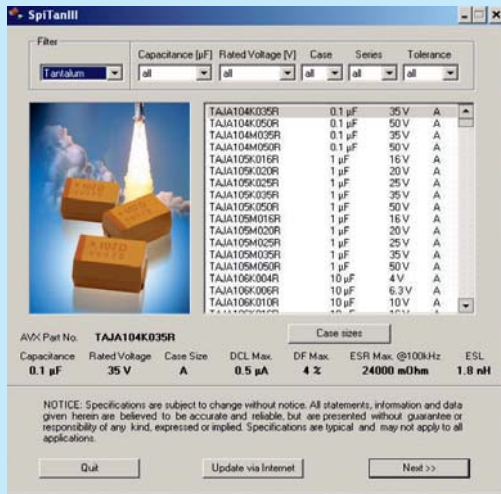

OUTPUT PARAMETERS

- Frequency characteristics of capacitance, impedance, ESR, DF for 25°C
- Temperature – shows performance according to selected operating temperature
- Frequency settings – shows values for given frequency
- Menu graph – shows additional performance figures for ripple characteristics (I,V), typical DCL performance within 5 min

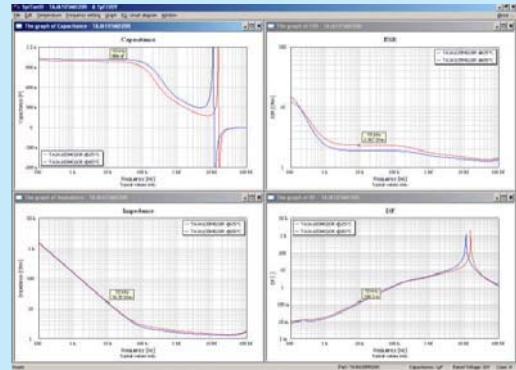

3D Models

3D Models support the design process and allow imagination of the PCB board component layout in 3D environment. The majority of AVX solid electrolytics case sizes are available in STEP format (Standard for the Exchange of Product Model Data).

PASSIVES

Capacitors

Multilayer Ceramic
Film
Glass
Niobium Oxide* - OxiCap®
Pulse Supercapacitors
Tantalum

Circuit Protection

Thermistors
Fuses - Thin Film
Transient Voltage Suppressors
Varistors - Zinc Oxide

Directional Couplers

Thin-Film

Filters

Ceramic
EMI
Noise
SAW
Low Pass - Thin Film

Inductors

Thin-Film

Integrated Passive Components

PMC - Thin-Film Networks
Capacitor Arrays
Feedthru Arrays
Low Inductance Decoupling Arrays

Piezo Acoustic Generators

Ceramic

Resistors

Arrays
Miniature Axials

Timing Devices

Clock Oscillators
MHz Quartz Crystal
Resonators
VCO
TCXO

CONNECTORS

Automotive

Standard, Custom

Board to Board

SMD (0.4, 0.5, 1.0mm), BGA, Thru-Hole

Card Edge

DIN41612

Standard, Inverse, High Temperature

FFC/FPC

0.3, 0.5, 1.0mm

Hand Held, Cellular

Battery, I/O, SIMcard, RF shield clips

2mm Hard Metric

Standard, Reduced Cross-Talk

IDC Wire to Board

Headers, Plugs, Assemblies

Memory

PCMCIA, Compact Flash, Secure Digital, MMC,
Smartcard, SODIMM

Military

H Government, DIN41612

Polytect™

Soft Molding

Rack and Panel

Varicon™

**For more information please visit
our website at
<http://www.avx.com>**

NOTICE: Specifications are subject to change without notice. Contact your nearest AVX Sales Office for the latest specifications. All statements, information and data given herein are believed to be accurate and reliable, but are presented without guarantee, warranty, or responsibility of any kind, expressed or implied. Statements or suggestions concerning possible use of our products are made without representation or warranty that any such use is free of patent infringement and are not recommendations to infringe any patent. The user should not assume that all safety measures are indicated or that other measures may not be required. Specifications are typical and may not apply to all applications.

© AVX Corporation

*Niobium Oxide Capacitors are manufactured and sold under patent license from Cabot Corporation, Boyertown, Pennsylvania U.S.A.™

Available Range of Sample Kits



SAMPLE WALLETS:

Number of PN's: 30

Number of pieces per PN: 5

ORANGE

OxiCap®
NOJ
 (Sample Kit: NOJ)
NOS, NOM
 (Sample Kit: NOS, NOM)



BLUE

TAJ Auto, TPS Auto, THJ, TRJ (Sample Kit: Automotive)
TAJ (Sample Kit: TAJ)
TPS (Sample Kit: TPS)
THJ (Sample Kit: Hi Temp THJ)
TRJ, TRM (Sample Kit: Industrial TRJ, TRM)
TPS, TPM (Sample Kit: Low ESR)
NOS, TPM, TPS, NOM (Sample Kit: Power Supply)
TPM (Sample Kit: TPM)
TAC (Sample Kit: TAC)



GREEN

Military and HI-REL Capacitors
CWR19, CWR29, CWR15
and various COTS+ products
 available only through the Sales
 or Marketing channels



BLACK

**Overview of our product series
 and matrixes**
 (Kit - Series)



PALE GREY

TLJ
 (Sample Kit: TLJ Low Profile)



CATALOG

**Polymer, Tantalum and Niobium
 Oxide Capacitors**
 (TANT-NBO-CATALOG)

SILVER

**TCJ, TAJ low, TLC,
 NOJ, TLJ, TLN**
 (Sample Kit: Mobile)



YELLOW

TCJ Voltage 2V-20V
 (Sample Kit: TCJ)
TCJ HiV Voltage 25V-125V
 (Sample Kit: TCJHIV)
J-CAP™
 (Sample Kit: J-CAP)
TCQ
 (Sample Kit: TCQ)



AMERICAS

AVX Greenville, SC
Tel: 864-967-2150

EUROPE

AVX Limited, England
Tel: +44-1276-697000

AVX S.A.S., France
Tel: +33-1-69-18-46-00

AVX GmbH, Germany
Tel: +49-0811-95949-0

AVX SRL, Italy
Tel: +39-02-614-571

AVX Czech Republic
Tel: +420-57-57-57-521

AVX/ELCO UK
Tel: +44-1638-675000

ELCO Europe GmbH
Tel: +49-2741-299-0

AVX S.A., Spain
Tel: +34-91-63-97-197

AVX Benelux
Tel: +31-187-489-337

ASIA-PACIFIC

AVX/Kyocera (S) Pte Ltd.,
Singapore
Tel: +65-6286-7555

AVX/Kyocera, Asia, Ltd.,
Hong Kong
Tel: +852-2363-3303

AVX/Kyocera Yuhan Hoesa,
South Korea
Tel: +82-2785-6504

AVX/Kyocera HK Ltd.,
Taiwan
Tel: +886-2-2656-0258

AVX/Kyocera (M) Sdn Bhd,
Malaysia
Tel: +60-4228-1190

AVX/Kyocera International
Trading Co. Ltd.,
Shanghai
Tel: +86-21-3255 1933

AVX/Kyocera Asia Ltd.,
Shenzen
Tel: +86-755-3336-0615

AVX/Kyocera International
Trading Co. Ltd.,
Beijing
Tel: +86-10-6588-3528

AVX/Kyocera India
Liaison Office
Tel: +91-80-6450-0715

ASIA-KED

(KYOCERA Electronic Devices)

KED Hong Kong Ltd.
Tel: +852-2305-1080/1223

KED Hong Kong Ltd.
Shenzen
Tel: +86-755-3398-9600

KED Company Ltd.
Shanghai
Tel: +86-21-3255-1833

KED Hong Kong Ltd.
Beijing
Tel: +86-10-5869-4655

KED Taiwan Ltd.
Tel: +886-2-2950-0268

KED Korea Yuhan Hoesa,
South Korea
Tel: +82-2-783-3604/6126

KED (S) Pte Ltd.
Singapore
Tel: +65-6509-0328

Kyocera Corporation
Japan
Tel: +81-75-604-3449

Contact:



<http://www.avx.com>

S-TL0M0317-C