

Silicon Power Schottky Diode

$V_{RRM} = 20\text{ V} - 40\text{ V}$

$I_{F(AV)} = 200\text{ A}$

Features

- High Surge Capability
- Types from 20 V to 40 V V_{RRM}
- Not ESD Sensitive

D-67 Package

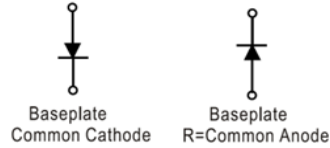

Maximum ratings, at $T_j = 25\text{ }^\circ\text{C}$, unless otherwise specified ("R" devices have leads reversed)

Parameter	Symbol	Conditions	MBRH20020(R)	MBRH20030(R)	MBRH20035(R)	MBRH20040(R)	Unit
Repetitive peak reverse voltage	V_{RRM}		20	30	35	40	V
RMS reverse voltage	V_{RMS}		14	21	25	28	V
DC blocking voltage	V_{DC}		20	30	35	40	V
Operating temperature	T_j		-55 to 150	-55 to 150	-55 to 150	-55 to 150	$^\circ\text{C}$
Storage temperature	T_{stg}		-55 to 150	-55 to 150	-55 to 150	-55 to 150	$^\circ\text{C}$

Electrical characteristics, at $T_j = 25\text{ }^\circ\text{C}$, unless otherwise specified

Parameter	Symbol	Conditions	MBRH20020(R)	MBRH20030(R)	MBRH20035(R)	MBRH20040(R)	Unit
Average forward current (per pkg)	$I_{F(AV)}$	$T_C = 125\text{ }^\circ\text{C}$	200	200	200	200	A
Peak forward surge current	I_{FSM}	$t_p = 8.3\text{ ms}$, half sine	3000	3000	3000	3000	A
Maximum instantaneous forward voltage	V_F	$I_{FM} = 200\text{ A}$, $T_j = 25\text{ }^\circ\text{C}$	0.70	0.70	0.70	0.70	V
Maximum instantaneous reverse current at rated DC blocking voltage	I_R	$T_j = 25\text{ }^\circ\text{C}$	1	1	1	1	mA
		$T_j = 100\text{ }^\circ\text{C}$	10	10	10	10	
		$T_j = 150\text{ }^\circ\text{C}$	50	50	50	50	

Thermal characteristics

Thermal resistance, junction-case	$R_{\theta JC}$		0.35	0.35	0.35	0.35	$^\circ\text{C/W}$
-----------------------------------	-----------------	--	------	------	------	------	--------------------

Figure .1-Typical Forward Characteristics

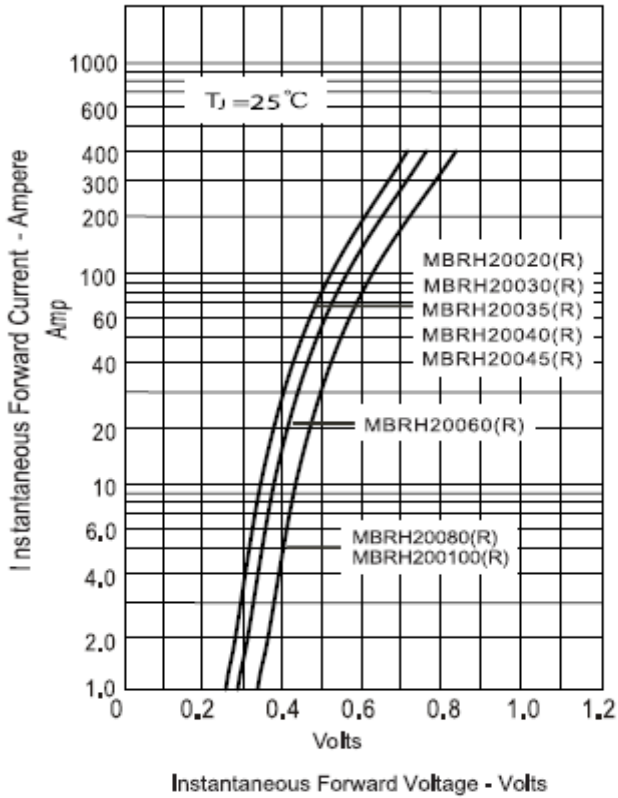

Figure .2-Forward Derating Curve

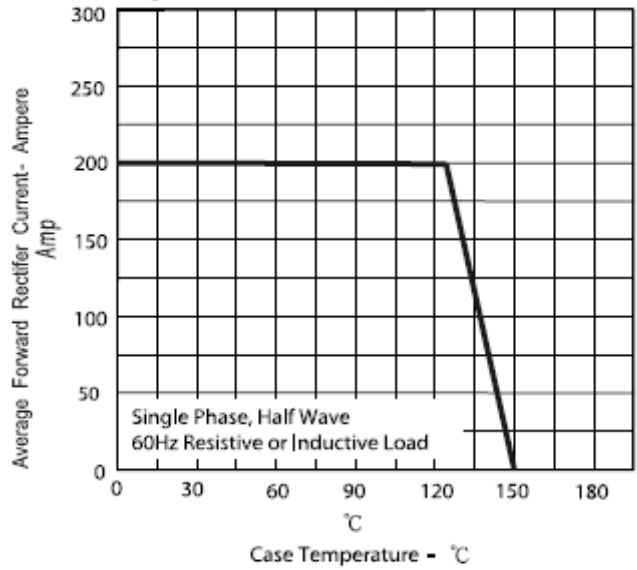

Figure .3-Peak Forward Surge Current

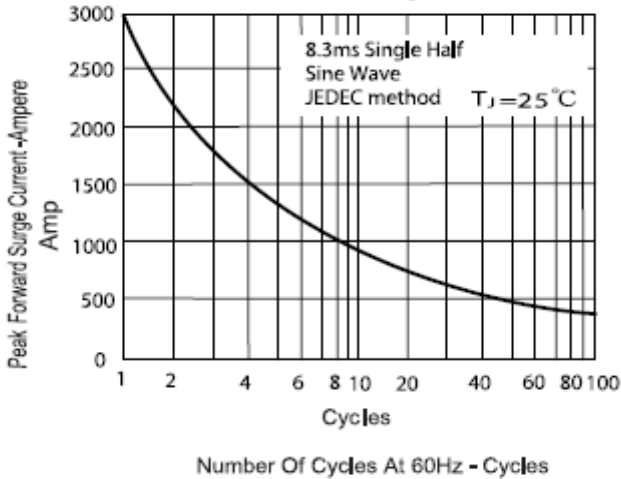
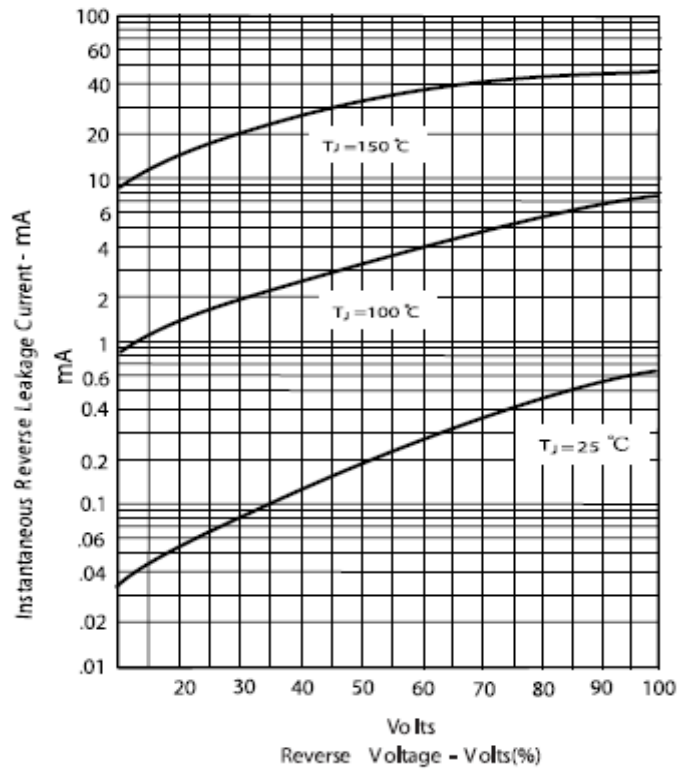
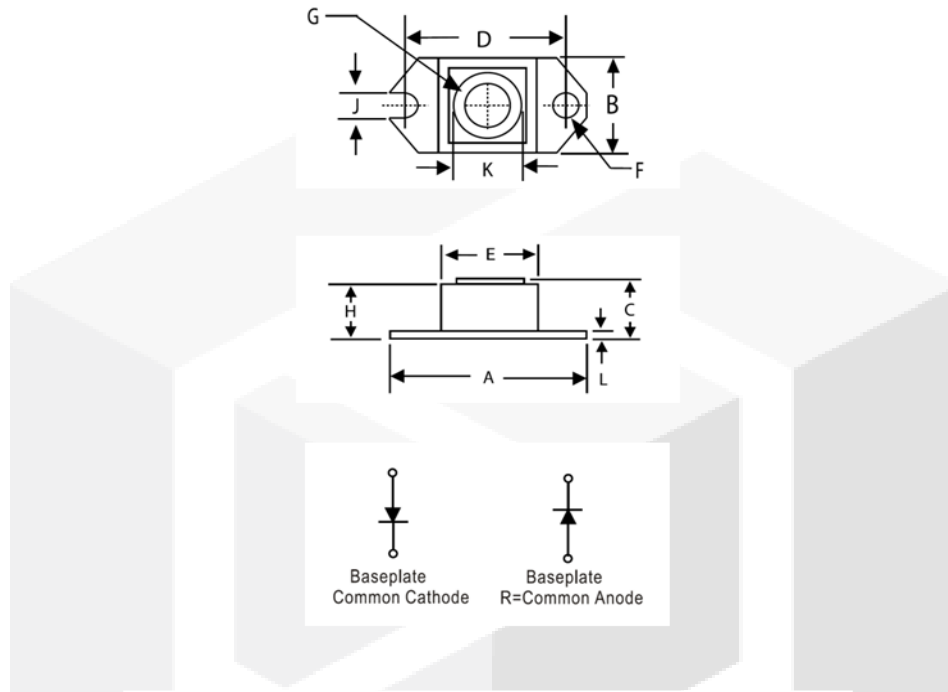

Figure .4- Typical Reverse Characteristics



Package dimensions and terminal configuration

Product is marked with part number and terminal configuration.



DIMENSIONS					NOTE
DIM	INCHES		MM		
	MIN	MAX	MIN	MAX	
A	1.515	1.560	38.48	39.62	
B	.725	.775	18.42	19.69	
C	.595	.625	15.11	15.88	
D	1.182	1.192	30.02	30.28	
E	.736	.744	18.70	18.90	
F	.152	.160	3.86	4.061	∅
G	1/4- 20 UNC				
H	.540	.580	13.72	14.73	
J	.156	.160	3.96	4.06	
K	.480	.492	12.20	12.50	∅
L	.120	.130	3.05	3.30	