

# IXIAN-DO<sup>TM</sup>

## Dissolved Oxygen Transmitter

Reads	<b>Dissolved Oxygen</b>
Range	<b>0.00 mg/L to 32.00 mg/L</b>
Accuracy	<b>+/- 0.2 mg/L</b>
Calibration	<b>1 or 2 point</b>
Supported probes	<b>Any type / brand of galvanic D.O. probe</b>
Auto temp compensation	<b>Yes</b>
Sea water compensation	<b>Yes</b>
Mount	<b>35mm Din rail</b>
Output	<b>4 – 20mA</b>
Operating voltage	<b>9VDC – 36VDC</b>
Electrically isolated	<b>Yes</b>

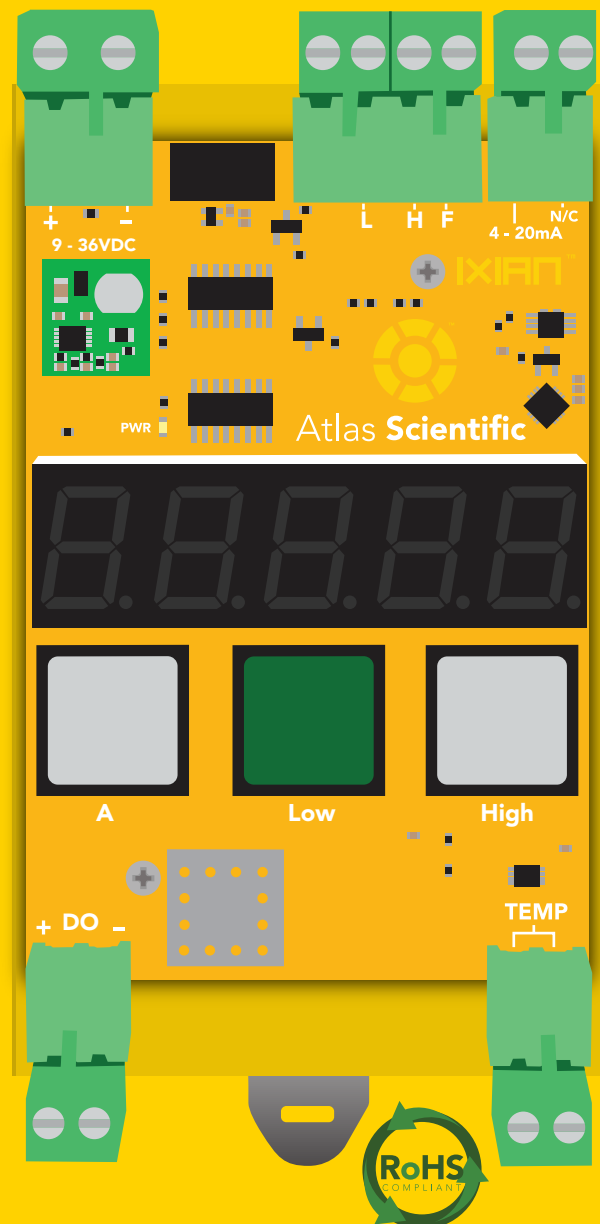

# Table of contents

Transmitter dimensions	3	Power connection	7
Wiring diagram	4	D.O. probe connection	8
Operating principle	5	Temperature connection	9
Mounting	6	4–20mA connection	10

4 – 20mA D.O. transmission	11
Reading 4 – 20mA output with a multimeter	12

PLC calibration node	13
Fault detect line	14

Calibration theory	15
High point calibration	16
Low point calibration	17
Seawater / freshwater setting	18
Calibration using a PLC	19

Temperature compensation	20
Factory reset	21

# Transmitter dimensions

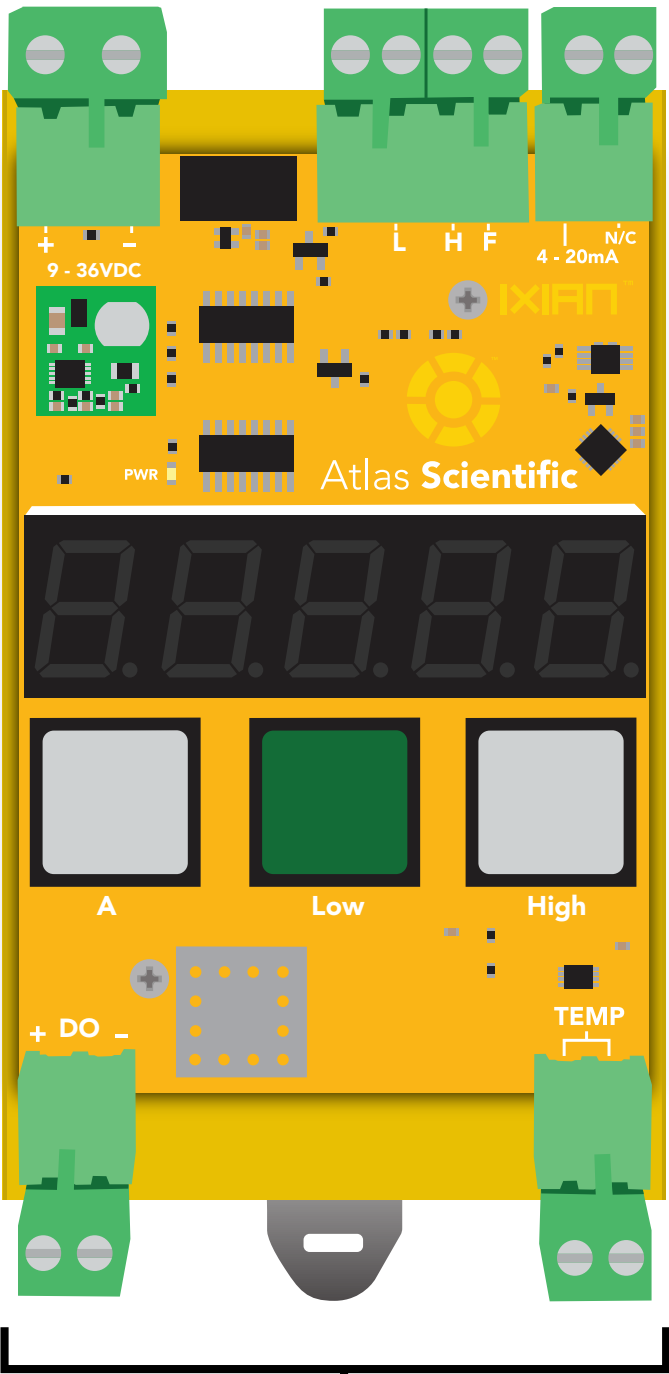

69.5mm  
(2.7")

128mm  
(5")

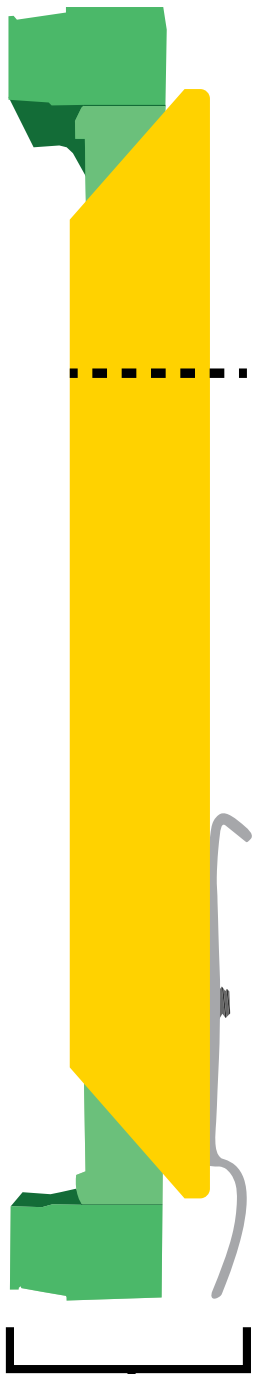

15.4mm  
(0.6")

51.2mm  
(2")

28mm  
(1.1")

# Wiring diagram

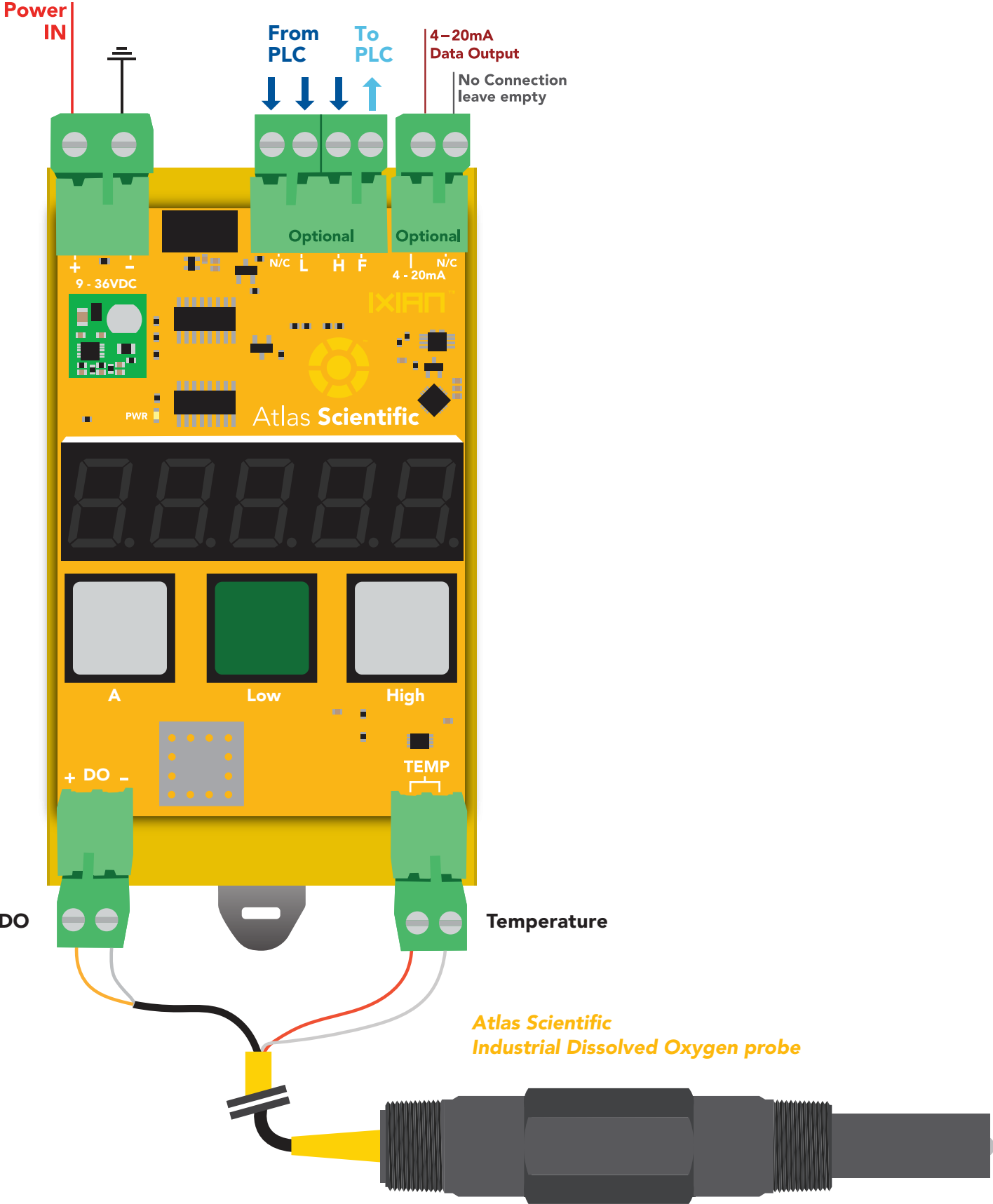

# Operating principle

The Atlas Scientific IXIAN™ Dissolved Oxygen Transmitter has been designed for use with a PLC in an industrial setting. The probe can be mounted in a pipe for in-line dissolved oxygen measurements, or it can be fully submerged underwater in a tank or other body of water.

For best results, the probe should be mounted in a fixed location.

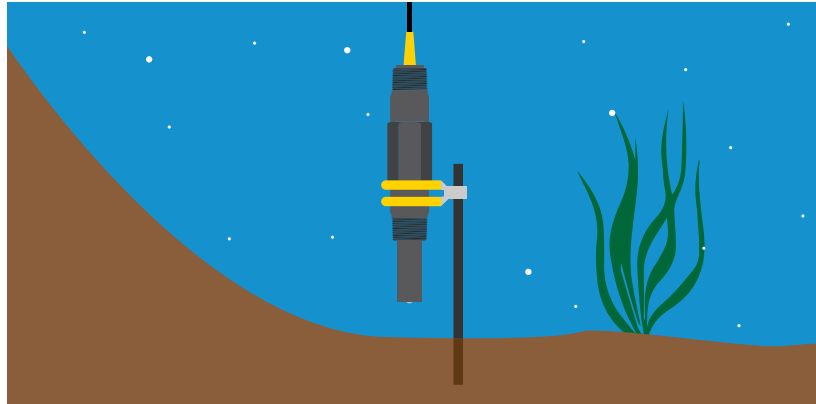
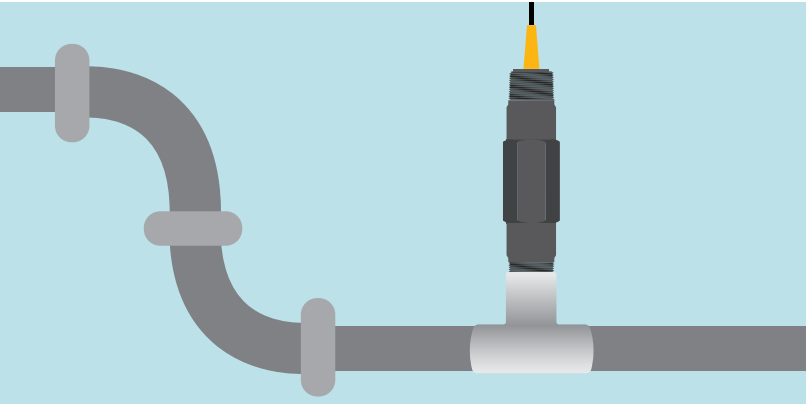

## Three factors that affect Dissolved Oxygen readings

- Temperature
- Salinity
- Atmospheric pressure

### Temperature compensation ✓

Cold water holds more oxygen than hot water. This transmitter uses ATC (automatic temperature compensation) to compensate for changes in water temperature. If no temperature probe is connected, the transmitter defaults to 20 °C.

### Salinity compensation ✓

Seawater holds less dissolved oxygen than freshwater. This transmitter is set to freshwater mode by default. If you are measuring the dissolved oxygen of seawater, page 18 shows how to set the transmitter to seawater mode.

### Atmospheric pressure compensation ✗

As altitude increases, atmospheric pressure decreases. This means there will be less oxygen available to dissolve into the water. This transmitter will be most accurate if used between 0–150 Meters (0–500 ft) above sea level. This transmitter does not have adjustable pressure compensation for use at high altitudes.

# Mounting

The IXIAN™ Dissolved Oxygen Transmitter is specifically designed to be mounted to a 35mm din rail. To detach the transmitter from the din rail, pull forward on the din rail release notch.

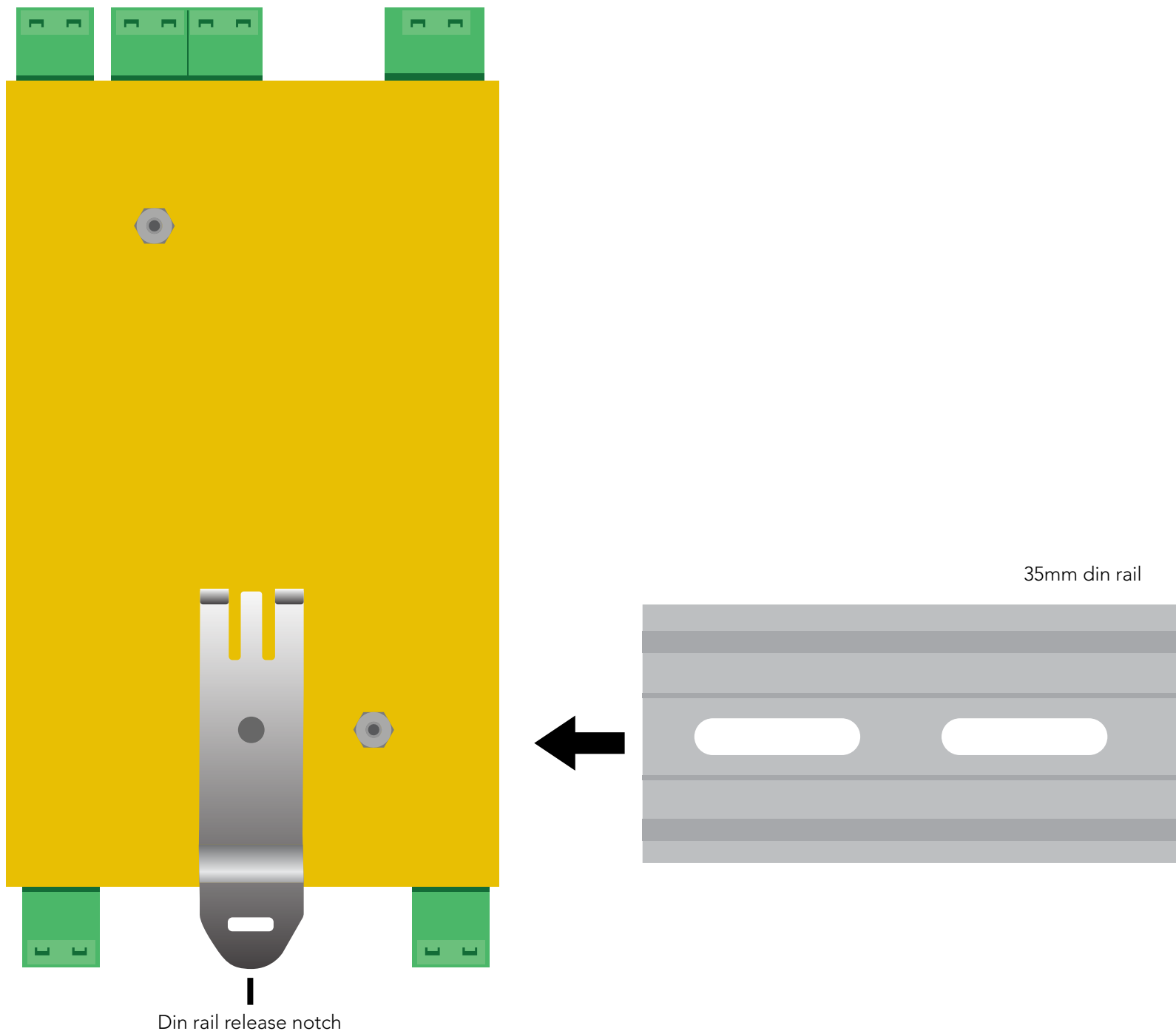

# Power connection

Any DC voltage from 9V – 36V can be used to power the IXIAN™ Dissolved Oxygen Transmitter. The power connector is keyed differently and is larger than the other connectors.

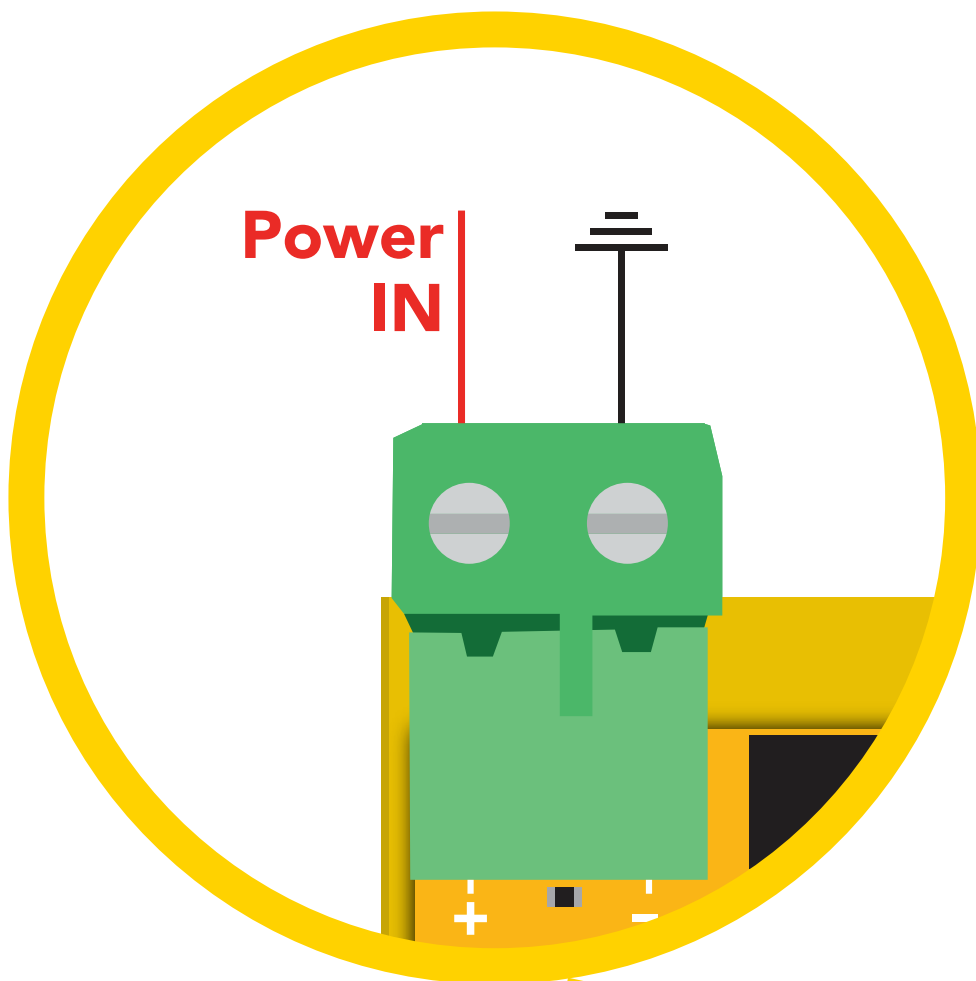

## Power consumption table

VDC	mA
9	70
12	52
24	28
36	20

The IXIAN™ Dissolved Oxygen Transmitter must be connected to a power source that provides a smooth, ripple free DC voltage. Any DC power supply designed for a PLC should be sufficient. Connecting this device to a cheap AC adapter also known as a "wall wart" may interfere with the devices ability to provide stable readings .

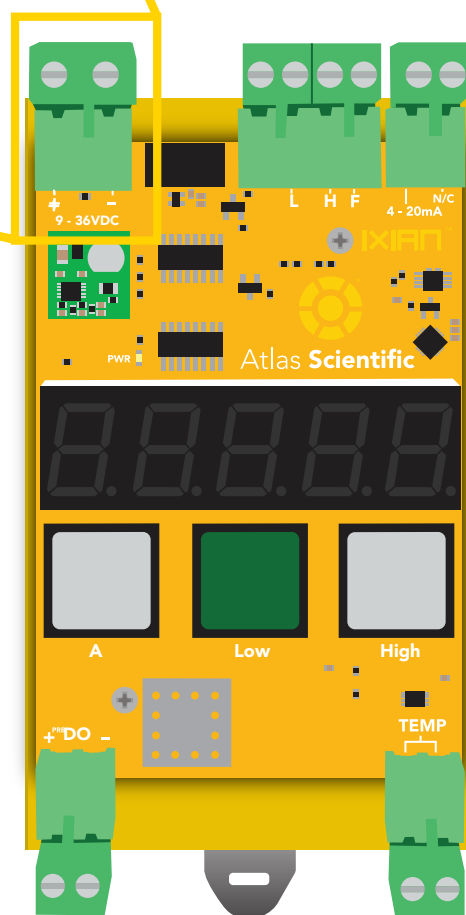

# D.O. probe connection

Any off the shelf galvanic dissolved oxygen probe can be used with the IXIAN™ Dissolved Oxygen Transmitter. For best results, use Atlas Scientifics **ENV-50-DO Industrial Dissolved Oxygen Probe**.

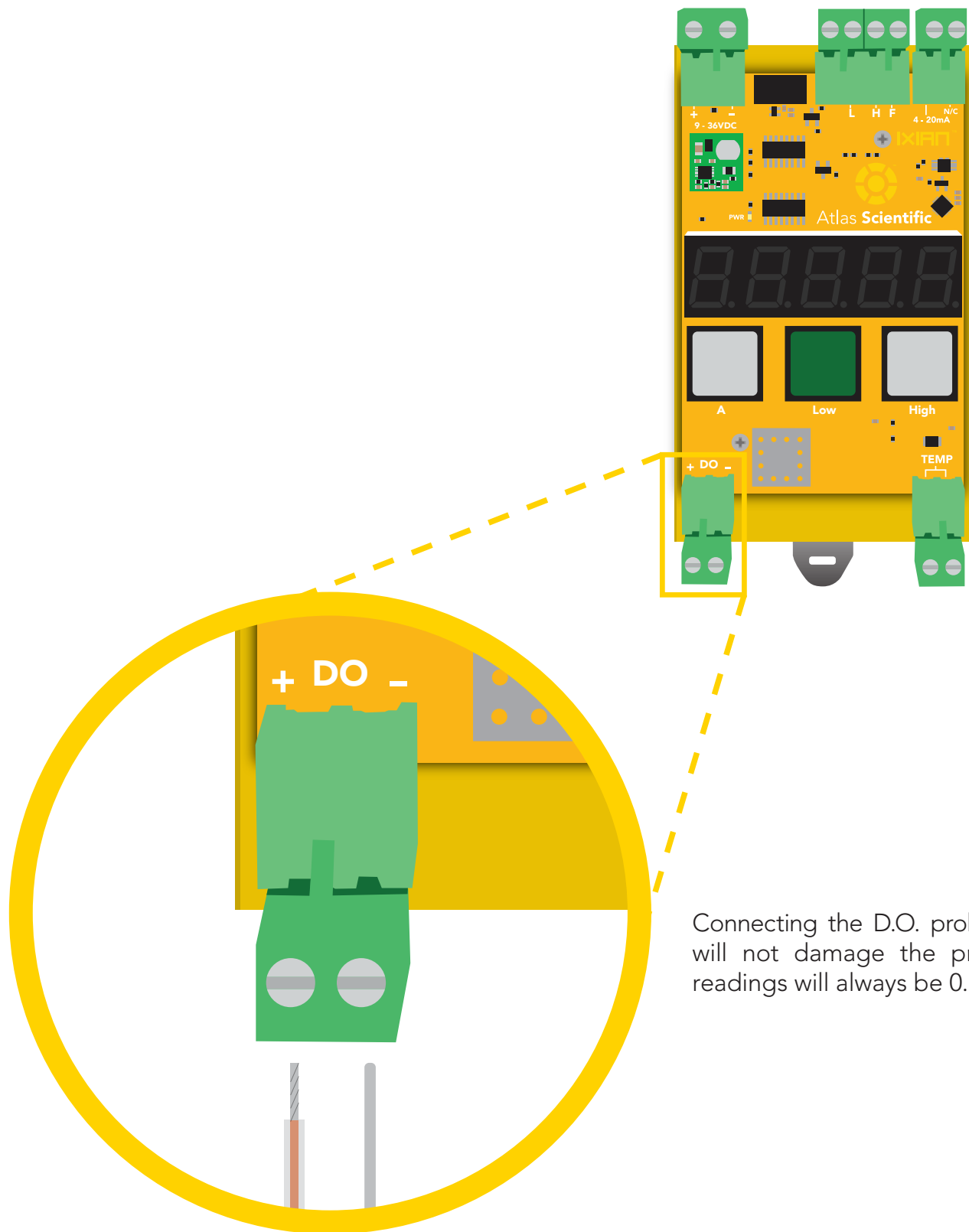

Connecting the D.O. probe in reverse order will not damage the probe however, the readings will always be 0.



# Temperature connection

Any brand of PT-100 or PT-1000 temperature probe can be used with the IXIAN™ D.O. Transmitter. For best results, use the built-in PT-1000 temp sensor from the Atlas Scientific **ENV-50-DO Industrial Dissolved Oxygen Probe**

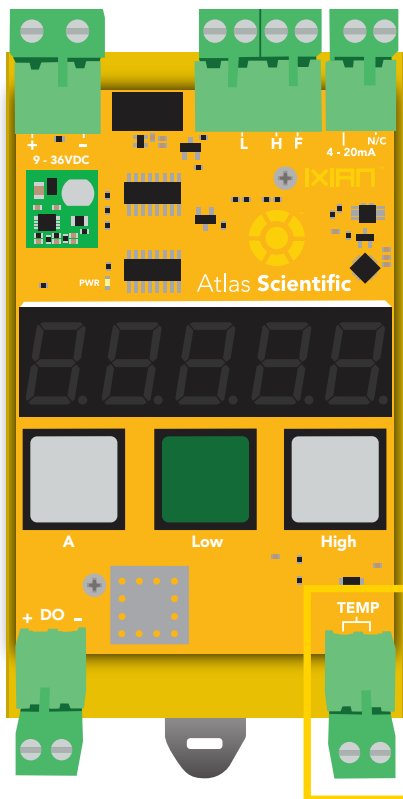

## Attention

Having the temperature sensor connected during calibration will make it difficult to know if calibration was done correctly. See page 15 for more info.

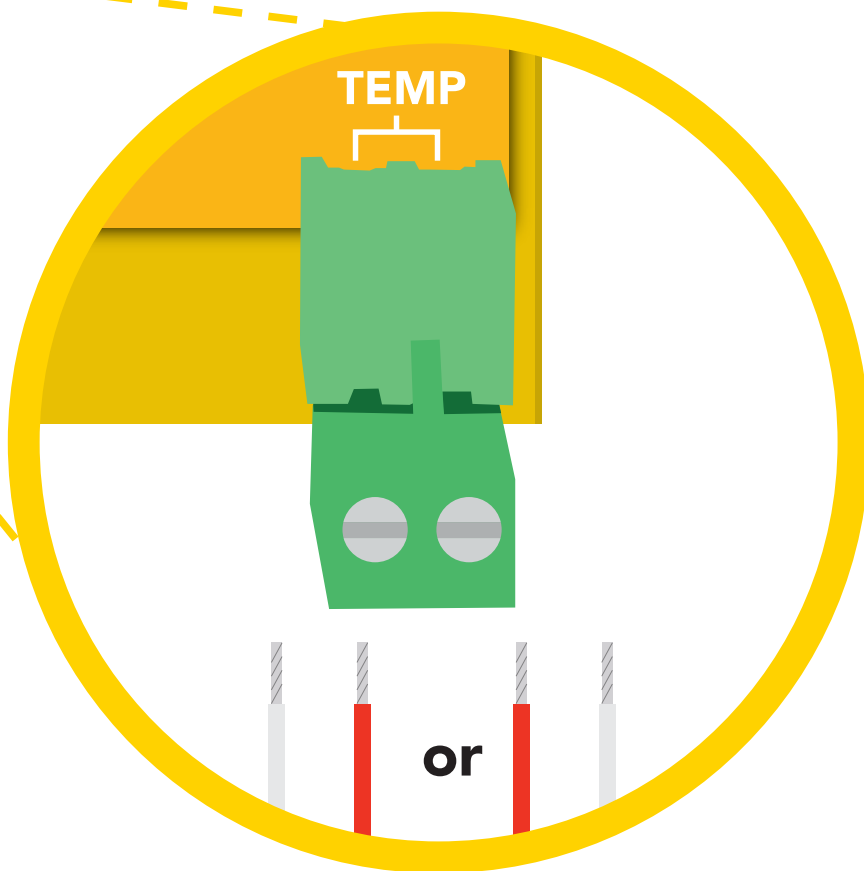

Either method of wiring will produce the same result. **There is no polarity.**

# 4 – 20mA connection

Connecting the 4–20mA data output to your PLC, allows the IXIAN™ Dissolved Oxygen Transmitter to communicate with your PLC.

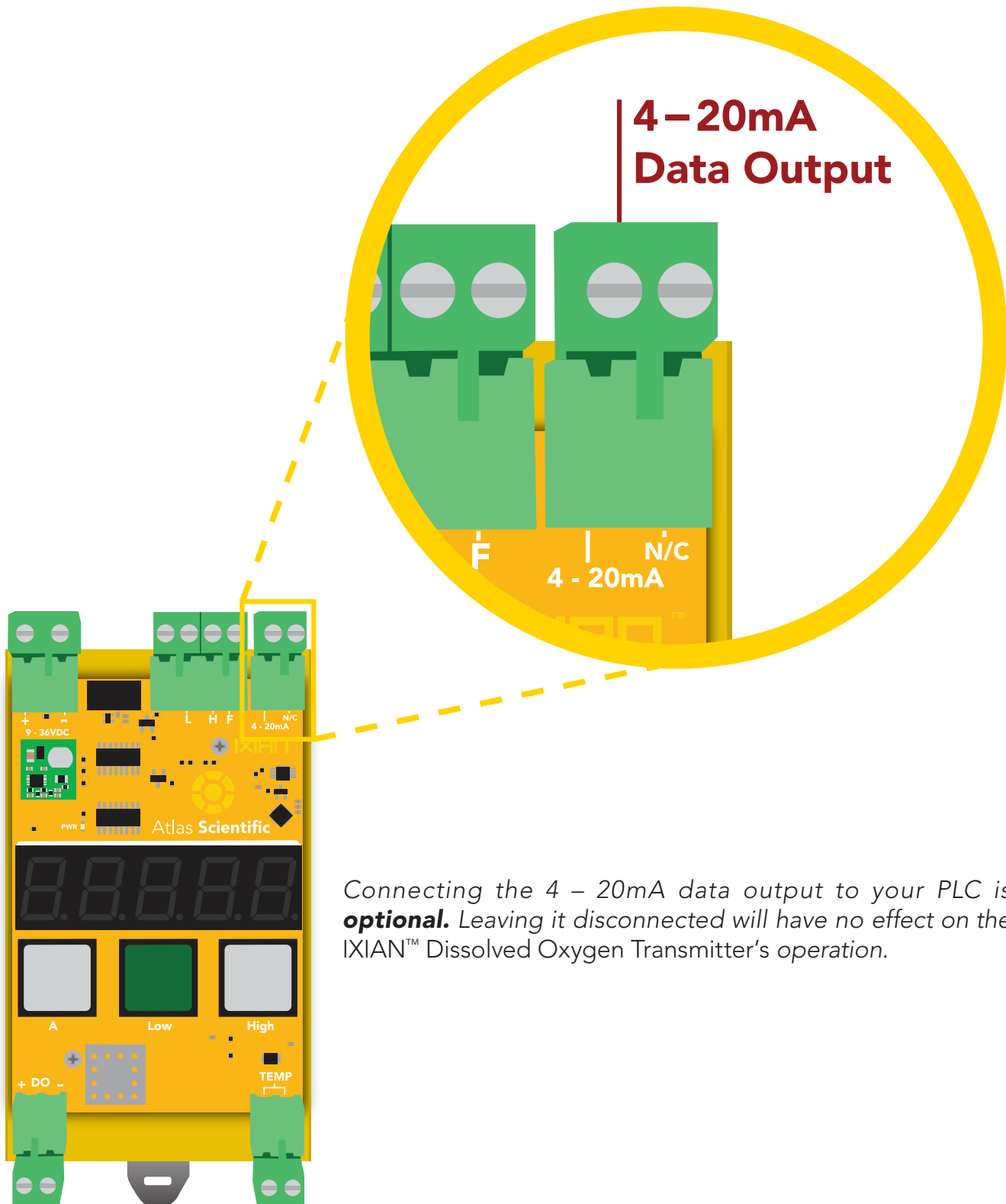

Connecting the 4 – 20mA data output to your PLC is **optional**. Leaving it disconnected will have no effect on the IXIAN™ Dissolved Oxygen Transmitter's operation.

# 4 – 20mA D.O. transmission

The Dissolved Oxygen value that is visible on the seven segment LED screen is also, simultaneously transmitted through the 4 – 20mA data output.

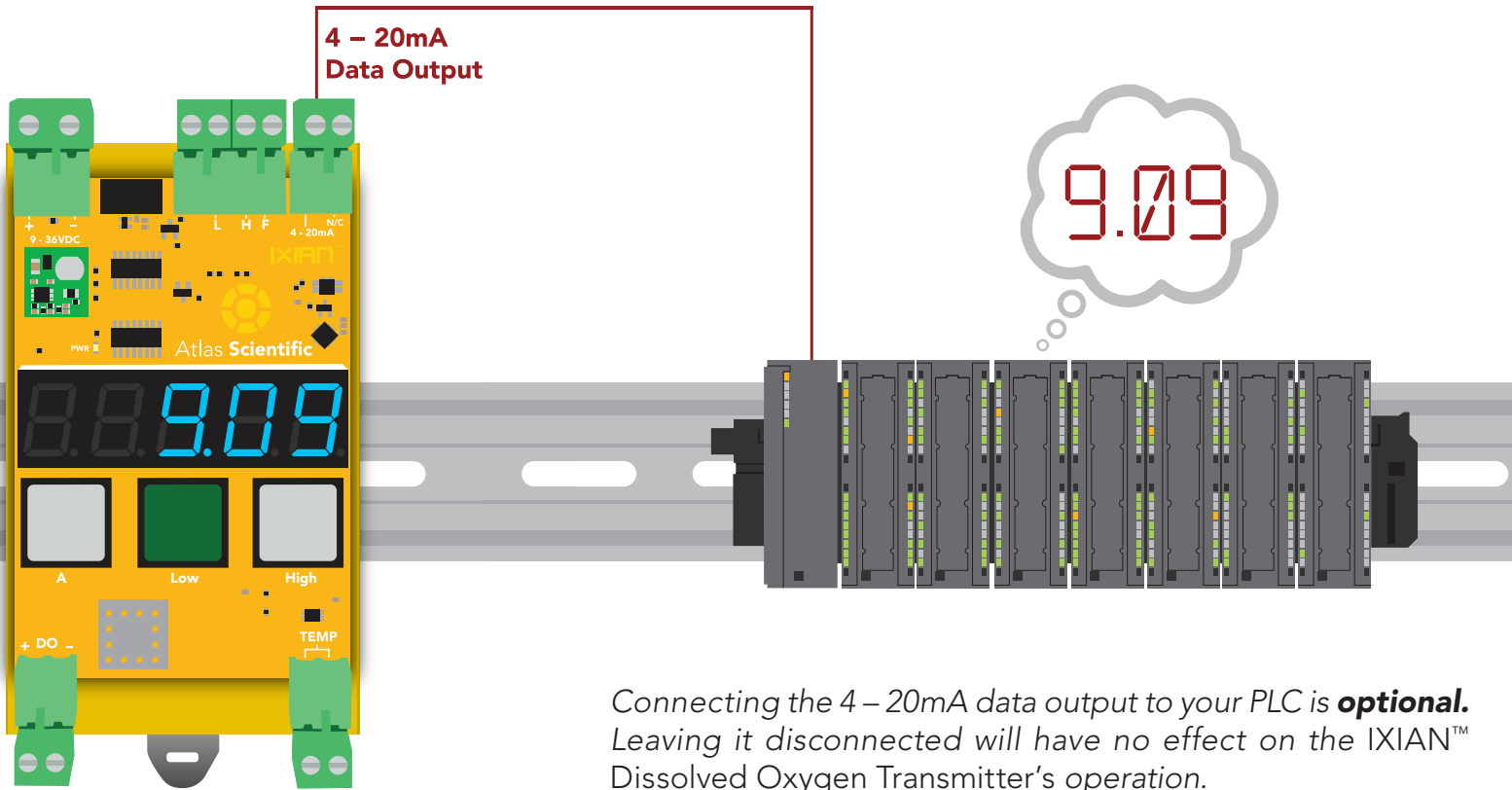

Connecting the 4 – 20mA data output to your PLC is **optional**. Leaving it disconnected will have no effect on the IXIAN™ Dissolved Oxygen Transmitter's operation.

## D.O. to 4–20mA equation

$$(Mg/L * 0.5) + 4 mA$$

## Advanced

4 – 20mA max load resistance

$$R_{max} = \frac{(V_{in} - 1)}{0.026}$$

R = the total resistive load on the line.  
V = the voltage powering the transmitter.

D.O.	mA
0.00	4
1	4.5
5	6.5
9.09	8.54
15	11.5
20	14
32	20

# Reading 4 – 20mA output with a multimeter

To debug the IXIAN™ Dissolved Oxygen Transmitter output, first connect it to a multimeter as shown (make sure the multimeter is set to “mA”). Once properly connected, press the “Cal high” button. Compare the reading on the multimeter to the chart below.

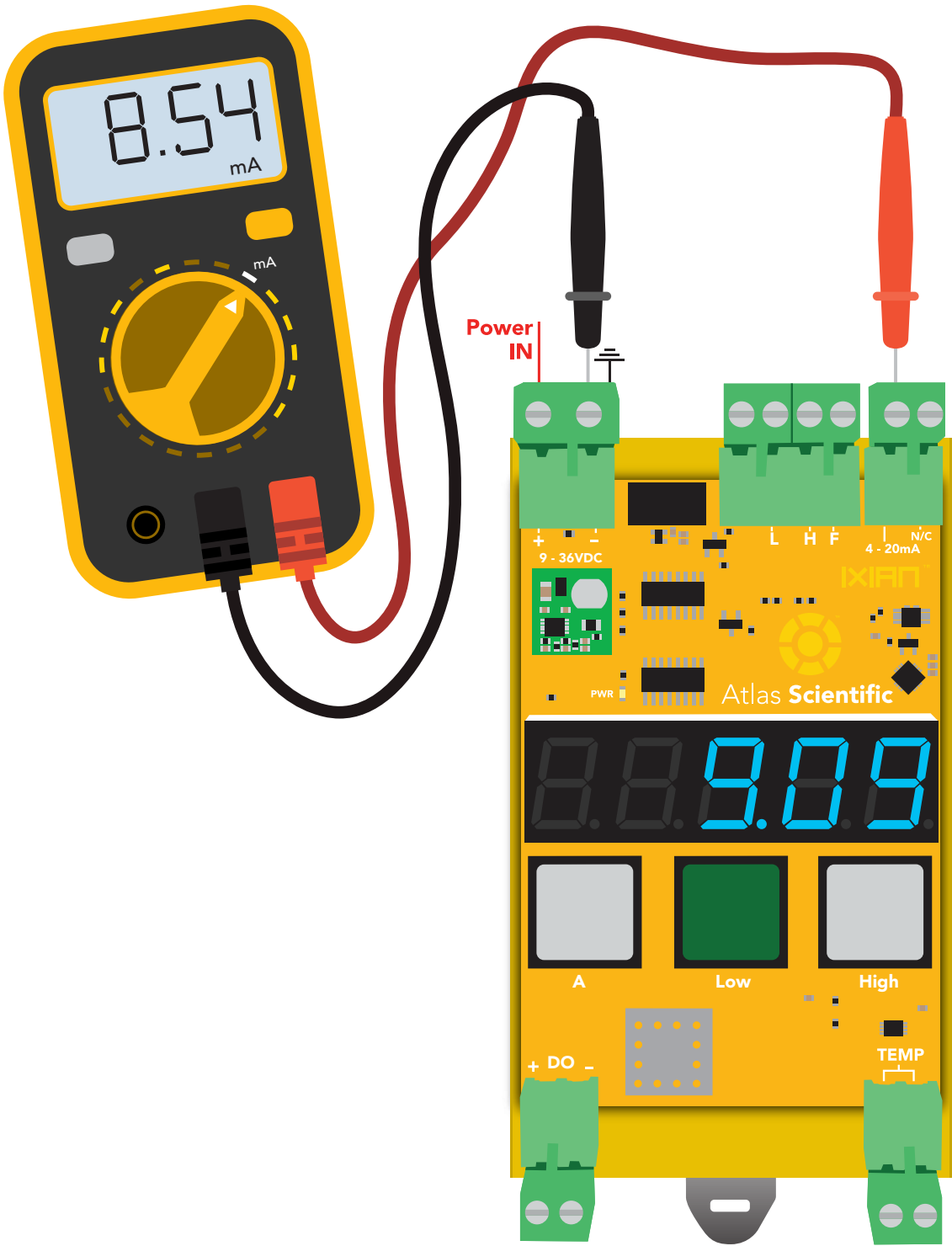

D.O.	mA
9.09	8.54

# PLC calibration node

Using the two input connections marked "L" and "H" (**Low and High**), it's possible to use a PLC to fully calibrate the IXIAN™ Transmitter. This is particularly beneficial when using a PLC touch screen. Setting either of these pins to high for 200ms, is the same as pressing the low or high calibration buttons on the transmitter.

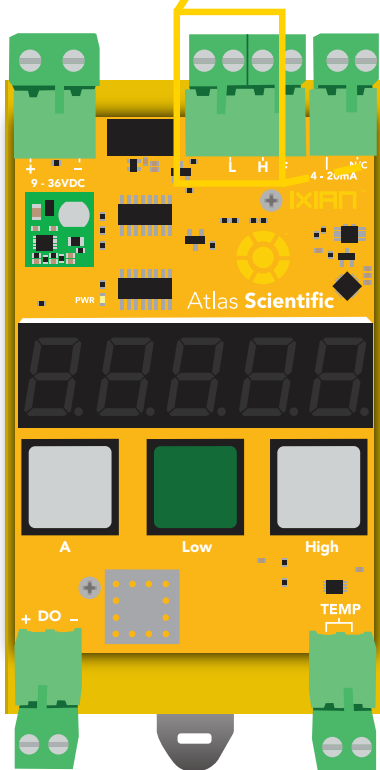
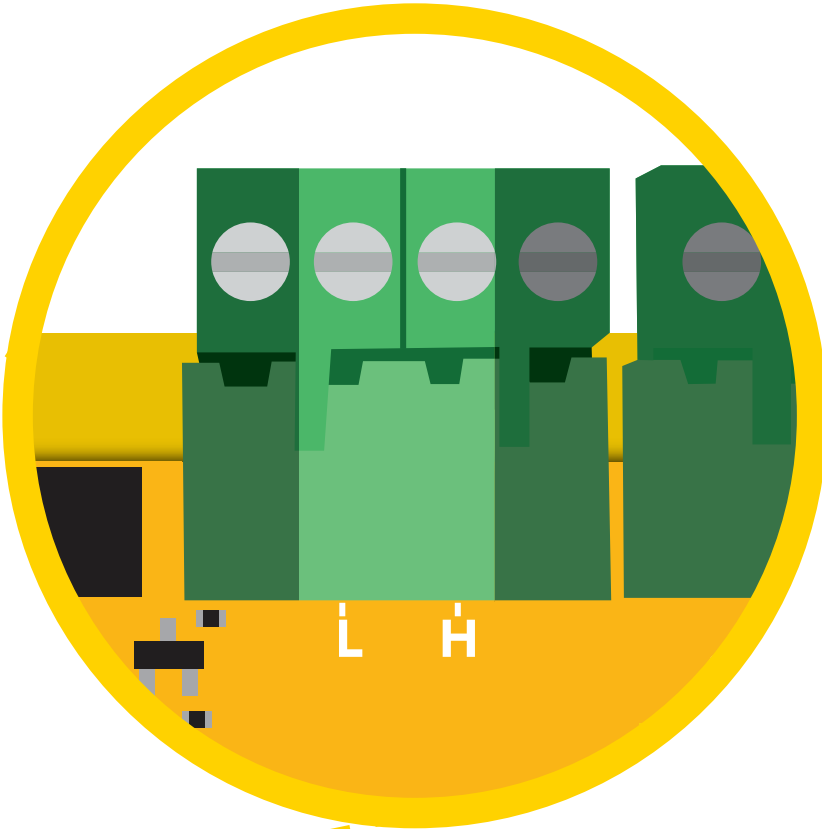

*The voltage used to trigger a calibration event should be the same voltage used to power the IXIAN™ Dissolved Oxygen Transmitter.*

*Connecting to the PLC calibration node is **optional**. Leaving it disconnected will have no effect on the IXIAN™ Dissolved Oxygen Transmitter's operation.*

# Fault detect line

The connection marked "F" is the fault detect line. During normal operation the fault detect line will output a voltage equal to the voltage used to power the device. If the IXIAN™ Dissolved Oxygen Transmitter detects a problem the fault line will drop to 0 volts.

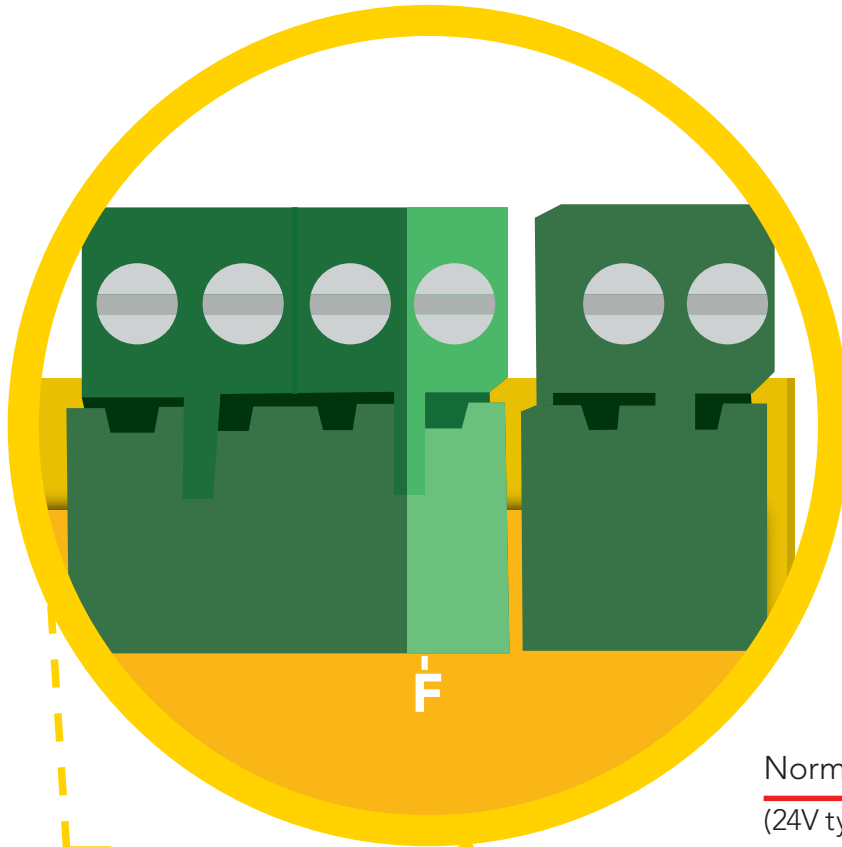

Normal operation

(24V typical)



**Fault**

0 Volts

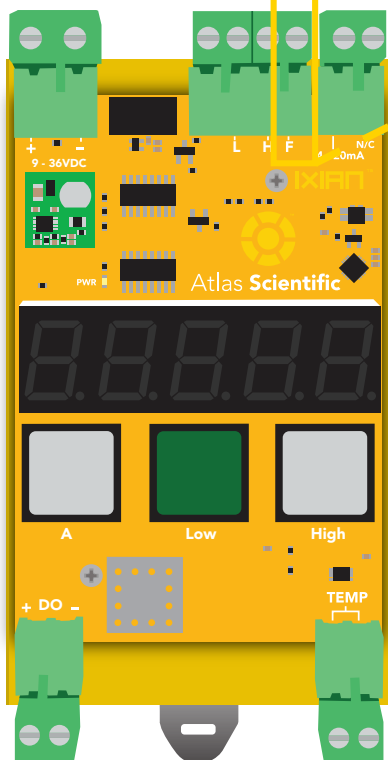

## Example

The IXIAN™ Dissolved Oxygen Transmitter is powered with 24V, the "F" line will output 24V during normal operation.

## Events that will trigger the fault line to go to 0 volts

- disconnected temperature probe
- disconnected 4–20mA output.
- calibration in process.
- loss of power.

Connecting to the fault detect line is **optional**. Leaving it disconnected will have no effect on the IXIAN™ Dissolved Oxygen Transmitter's operation.

# Calibration theory

The IXIAN™ Dissolved Oxygen Transmitter uses two point calibration: **low** and **high**.

**High point** calibration is the only necessary calibration point.

**Low point** calibration is only required if **high accuracy** measurements are needed when the dissolved oxygen levels are less than 1.5 mg/L

## Calibration tips

Don't breathe directly on the probe when calibrating. The probe can detect that.

Moving the probe around, touching the sensing area, and putting the probe in water will cause the readings to jump up. This is normal; the readings will return to the proper level after a few minutes.

Before calibrating the probe, disconnect the temperature probe from the transmitter. Temperature **compensation** is not part of **calibration**. Disconnecting the temperature probe makes the calibration process easier. Leaving the temperature probe connected, does not invalidate the calibration. It just makes it harder to tell if calibration was done correctly.



**Temperature disconnected**

Air temperature is not part of a dissolved oxygen reading. When a calibration button is pressed, 20°C is used as the temperature.

If you leave the temp probe connected, immediately after calibration the air temp will be used to give a dissolved oxygen reading. Unless the air temp is also 20°C you will not see a predicted value indicating calibration was done correctly.

# High point calibration

With the dissolved oxygen probe sitting out in the air, and the temp sensor disconnected, let the readings stabilize. This usually takes no more than a few minutes; once the readings have stabilized, press and hold the "High" button for 1.5 seconds.



When high point calibration is complete, the readings will be:

Freshwater mode  
**9.09 +/- 0.02**

Seawater mode  
**7.47 +/- 0.02**

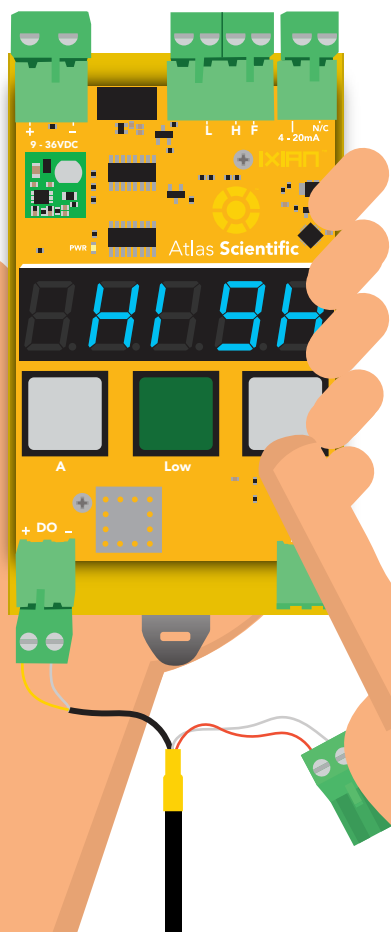

**1.5 seconds**

You may see the readings start to rise slowly after calibration. This is not uncommon. Simply press "high" calibration button again. This can be done many times; each time, your calibration will become more accurate. "Perfect Calibration" does not exist. It's a psychological trap. Limit high point calibration attempts to no more than 10 minutes.



# Low point calibration

This step is only needed if **high accuracy** measurements are required for dissolved oxygen readings less than 1.5 mg/L.

Place the probe in the zero dissolved oxygen calibration solution.



The readings will quickly start dropping and eventually stabilize to a number less than one (*typically 0.7mg/L or less*). Press and hold the "**Low**" button for 1.5 seconds.

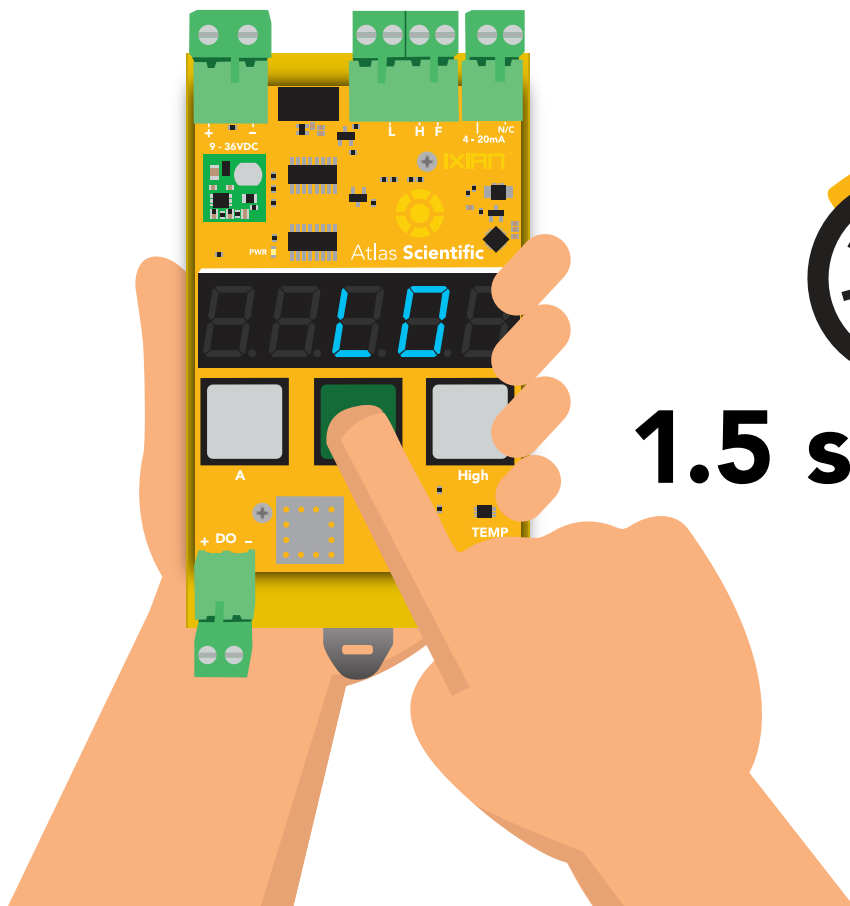

## 1.5 seconds

# Seawater / freshwater setting

Freshwater holds more dissolved oxygen than seawater. The Atlas Scientific IXIAN Dissolved Oxygen Transmitter is set to freshwater mode by default. If the D.O. probe is going to be used in seawater, the transmitter should be set to seawater mode.

Press **A** to see what mode the transmitter is set to.

## Freshwater mode



## Seawater mode



To change the setting press and hold **A** and **High** buttons for 1.5 seconds. The screen will flash "**SER**" twice, indicating the setting has been changed.

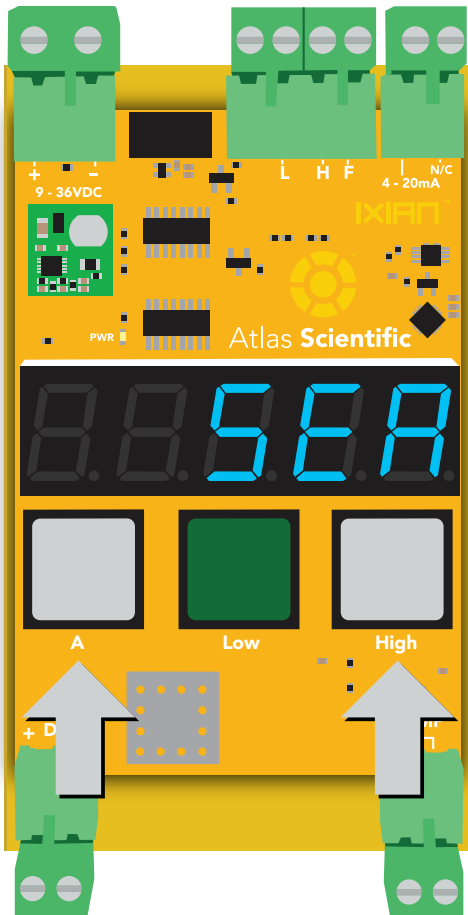

# 1.5 seconds

# Calibration using a PLC

Using the Two input connections marked "L", "H" (Low and High) it is possible to use a PLC to fully calibrate the IXIAN™ Dissolved Oxygen Transmitter. Setting a PLC's output pin high for 200ms or more will trigger a calibration event.

This is particularly beneficial when using a PLC touch screen.



The voltage used to trigger a calibration event should be the same voltage used to power the IXIAN™ Dissolved Oxygen Transmitter.

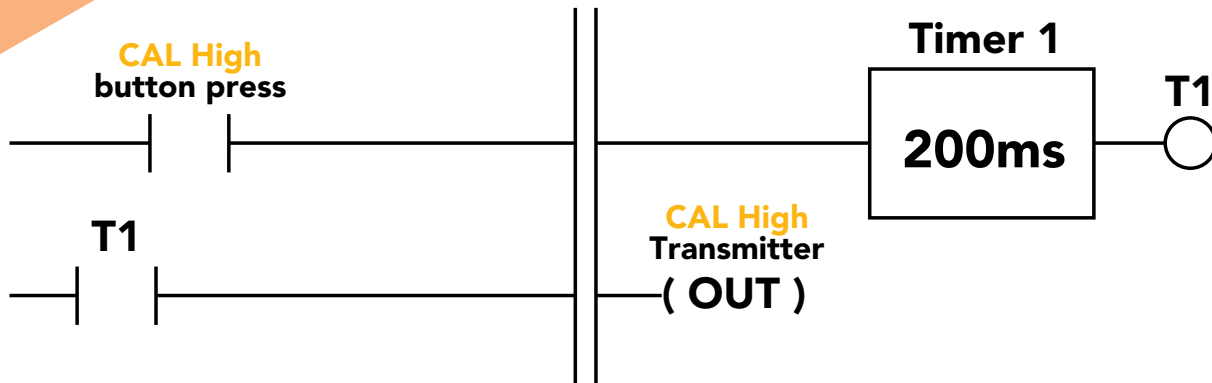

A calibration event will only trigger if the corresponding input pin has been held high for 200ms. Holding the line for more than 200ms will have no effect.

# Temperature compensation

To view the temperature that the IXIAN™ Dissolved Oxygen Transmitter is reading from the attached PT-100, or PT-1000 temperature probe, press the **A** and **Low** buttons simultaneously. The display will now show the temperature. It will continue to display the temperature for 10 seconds.

If a temperature probe is not connected, the transmitter will use 20 °C as the default temperature.

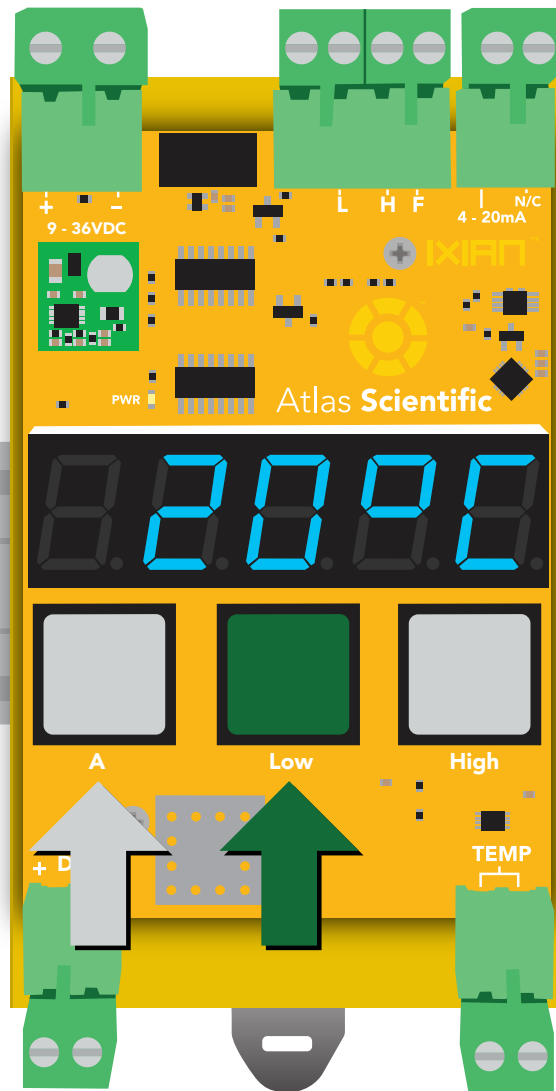

**Temperature data cannot be output to PLC.**

# Factory reset

The IXIAN™ Dissolved Oxygen Transmitter can be reset to its default settings. To issue a factory reset, press and hold the **Low** and **High** buttons for three seconds.

The display will flash: *rESEt*

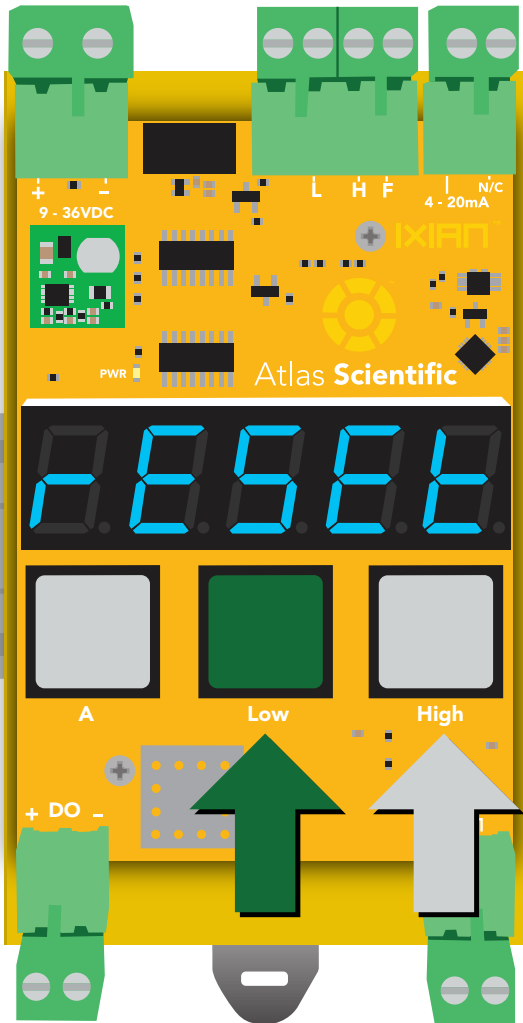

**3 seconds**

Press and hold the **Low** and **High** buttons again to confirm the factory reset. To cancel a factory reset, press the **A** button

# Datasheet change log

## Datasheet V 1.0

New datasheet

## Datasheet V 1.1

Revised Factory reset information on pg 21.