

Data sheet | Item number: 2061-1601/998-404

THR PCB terminal block; push-button; 1.5 mm²; Pin spacing 6 mm; 1-pole;
Push-in CAGE CLAMP®; in tape-and-reel packaging; 1,50 mm²; white



www.wago.com/2061-1601/998-404



Subject to changes. Please also observe the further product documentation!

WAGO GmbH & Co. KG
Hansastr. 27
32423 Minden
Phone: +49571 887-0 | Fax: +49571 887-169
Email: info.de@wago.com | Web: www.wago.com

Do you have any questions about our products?
We are always happy to take your call at +49 (571) 887-44222.



Current-Carrying Capacity Curve

Pin spacing: 6 mm / Conductor cross-section: 1.5 mm² "e"
Based on: EN 60512-5-2 / Reduction factor: 1

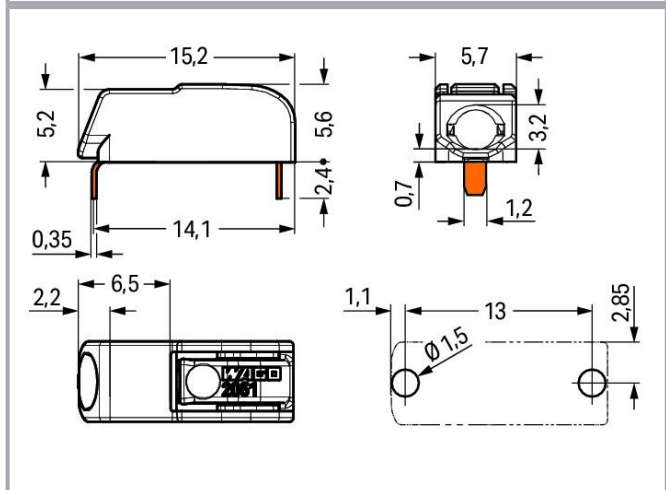
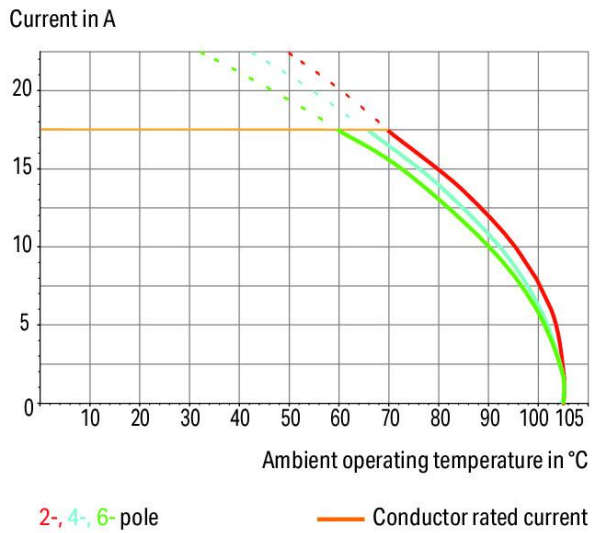

Subject to changes. Please also observe the further product documentation!

WAGO GmbH & Co. KG
Hansastr. 27
32423 Minden
Phone: +49571 887-0 | Fax: +49571 887-169
Email: info.de@wago.com | Web: www.wago.com

Do you have any questions about our products?
We are always happy to take your call at +49 (571) 887-44222.

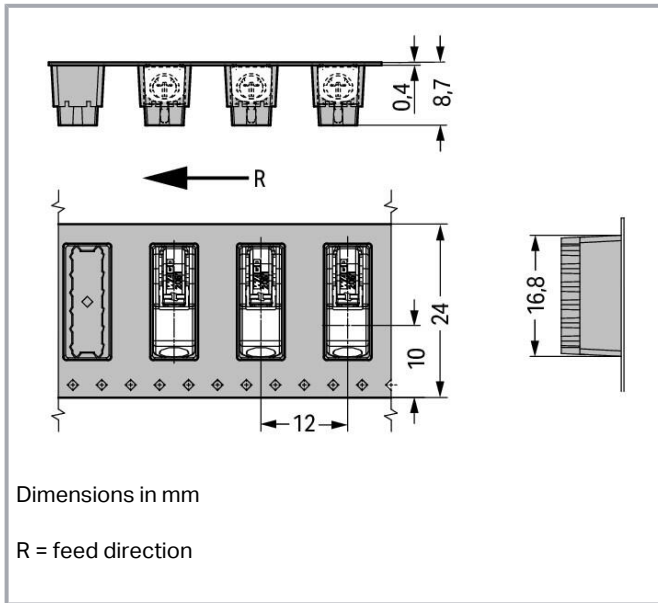

Item description

- THR PCB terminal blocks with Push-in CAGE CLAMP[®] connection technology and push-buttons
- Push-in termination of solid and ferruled conductors
- Convenient termination/removal of fine-stranded conductors via push-buttons
- Just 5.6 mm tall
- Available in tape-and-reel packaging for automated assembly
- Also suitable for wave soldering
- Assemble terminal blocks without pole loss

Data

Notes

Note

Application notes:

Suitable for lead-free, reflow-soldering profiles per DIN EN 61760-1 and IEC 60068-2-58 up to max. 260°C peak temperature. Due to application-specific variables (component configuration and orientation, type of soldering machine, solder paste), trial runs are recommended to ensure product and process compatibility under actual manufacturing conditions.

Note

Subject to changes. Please also observe the further product documentation!



Depending on reflow soldering temperatures and times, color deviations may occur. These deviations will have no impact on functionality.

Recommendation

Recommendation for stencil:

150 µm material thickness
Stencil hole diameter identical to metal-plated PCB hole outer diameter

Electrical data

Ratings per IEC/EN

Ratings per	IEC/EN 60664-1
Nominal voltage (III/3)	250 V
Rated impulse voltage (III/3)	4 kV
Rated voltage (III/2)	320 V
Rated impulse voltage (III/2)	4 kV
Nominal voltage (II/2)	630 V
Rated surge voltage (II/2)	4 kV
Rated current	17.5 A
Legend (ratings)	(III / 2) ≙ Overvoltage category III / Pollution degree 2

Ratings per UL 1059

Approvals per	UL 1059
Rated voltage UL (Use Group B)	600 V
Rated current UL (Use Group B)	10 A
Rated voltage UL (Use Group D)	600 V
Rated current UL (Use Group D)	5 A

Connection data

Connection points	1
Total number of potentials	1
Number of connection types	1
Number of levels	1

Subject to changes. Please also observe the further product documentation!



Connection 1

Connection technology	Push-in CAGE CLAMP®
Actuation type	Push-button
Solid conductor	0.25 ... 1.5 mm ² / 20 ... 16 AWG
Fine-stranded conductor	0.5 ... 1.5 mm ² / 20 ... 16 AWG
Fine-stranded conductor; with insulated ferrule	0.5 ... 0.75 mm ²
Fine-stranded conductor; with uninsulated ferrule	0.5 ... 0.75 mm ²
Strip length	7 ... 10 mm / 0.28 ... 0.39 inches
Conductor connection direction to PCB	0°
Pole number	1

Physical data

Pin spacing	6 mm / 0.24 inches
Width	5.7 mm / 0.224 inches
Height	8 mm / 0.315 inches
Height from the surface	5.6 mm / 0.22 inches
Depth	15.2 mm / 0.598 inches
Solder pin length	2.4 mm
Solder pin dimensions	1.2 x 0.35 mm
Plated through-hole diameter (THR)	1.5 ^(+0.1) mm
Reel diameter of tape-and-reel packaging	330 mm
Tape width	24 mm

Plug-in connection

Plugging without loss of pin spacing	Yes
--------------------------------------	-----

PCB contact

PCB contact	THR
Solder pin arrangement	Over the entire terminal strip (in-line)
Number of solder pins per potential	2

Material Data

Note (material data)

Information on material specifications can be found here

Subject to changes. Please also observe the further product documentation!



Color	white
Material group	I
Insulation material	Polyphthalamide (PPA GF)
Flammability class per UL94	V0
Contact material	Copper alloy
Contact plating	Tin
Weight	0.5 g
MSL gemäß J-STD 020D	1

Environmental requirements

Limit temperature range	-60 ... +105 °C
-------------------------	-----------------

Commercial data



eCl@ss 10.0	27-14-11-06
eCl@ss 9.0	27-14-11-06
ETIM 8.0	EC001284
ETIM 7.0	EC001284
PU (SPU)	5760 (640) pcs
Packaging type	box
Country of origin	CH
GTIN	4055143274715
Customs tariff number	85369010000

Environmental Product Compliance

RoHS Compliance Status	Compliant, No Exemption
------------------------	-------------------------

Approvals / Certificates

General approvals

Logo	Approval	Additional Approval Text	Certificate name
	CCA DEKRA Certification B.V.	EN 60947-7-4	NTR NL-7773
	CCA DEKRA Certification B.V.	EN 60947-7-4	71-110254

Subject to changes. Please also observe the further product documentation!



CCA
DEKRA Certification B.V.

EN 60838

NTR NL-
7721



cURus
Underwriters Laboratories Inc.

UL 1059

E45172











KEMA/KEUR
DEKRA Certification B.V.

EN 60838

71-
106232

Optional accessories

Ferrule

Ferrule		
	Item no.: 216-101 Ferrule; Sleeve for 0.5 mm ² / AWG 22; uninsulated; electro-tin plated; silver-colored	www.wago.com/216-101
	Item no.: 216-102 Ferrule; Sleeve for 0.75 mm ² / AWG 20; uninsulated; electro-tin plated; silver-colored	www.wago.com/216-102
	Item no.: 216-142 Ferrule; Sleeve for 0.75 mm ² / 18 AWG; uninsulated; electro-tin plated; electrolytic copper; gastight crimped; acc. to DIN 46228, Part 1/08.92	www.wago.com/216-142
	Item no.: 216-141 Ferrule; Sleeve for 0.5 mm ² / 20 AWG; uninsulated; electro-tin plated; electrolytic copper; gastight crimped; acc. to DIN 46228, Part 1/08.92	www.wago.com/216-141
	Item no.: 216-202 Ferrule; Sleeve for 0.75 mm ² / 18 AWG; insulated; electro-tin plated; gray	www.wago.com/216-202
	Item no.: 216-201 Ferrule; Sleeve for 0.5 mm ² / 20 AWG; insulated; electro-tin plated; white	www.wago.com/216-201
	Item no.: 216-241 Ferrule; Sleeve for 0.5 mm ² / 20 AWG; insulated; electro-tin plated; electrolytic copper; gastight crimped; acc. to DIN 46228, Part 4/09.90; white	www.wago.com/216-241
	Item no.: 216-242 Ferrule; Sleeve for 0.75 mm ² / 18 AWG; insulated; electro-tin plated; electrolytic copper; gastight crimped; acc. to DIN 46228, Part 4/09.90; gray	www.wago.com/216-242
	Item no.: 216-262 Ferrule; Sleeve for 0.75 mm ² / 18 AWG; insulated; electro-tin plated; electrolytic copper; gastight crimped; acc. to DIN 46228, Part 4/09.90; gray	www.wago.com/216-262

Tool

Operating tool

Subject to changes. Please also observe the further product documentation!

WAGO GmbH & Co. KG
Hansastr. 27
32423 Minden
Phone: +49571 887-0 | Fax: +49571 887-169
Email: info.de@wago.com | Web: www.wago.com

Do you have any questions about our products?
We are always happy to take your call at +49 (571) 887-44222.



Item no.: 2061-190

Operating tool; made of insulating material

www.wago.com/2061-190



Item no.: 206-866

Operating tool; for 2061 Series

www.wago.com/206-866

Downloads

Documentation

Additional Information

Technical Section	2019 Apr 3	pdf	Download
Technical explanations		2.0 MB	
THR Soldering Process		pdf	Download
		548.2 kB	

CAD/CAE-Data

CAD data

2D/3D Models 2061-1601/998-404	URL	Download
--------------------------------	-----	----------

PCB Design

Symbol and Footprint 2061-1601/998-404	URL	Download
--	-----	----------

CAX data for your PCB design, consisting of "schematic symbols and PCB footprints", allow easy integration of the WAGO component into your development environment.

Supported formats:

- Accel EDA 14 & 15
- Altium 6 to current version
- Cadence Allegro
- DesignSpark
- Eagle Libraries
- KiCad
- Mentor Graphics BoardStation
- Mentor Graphics Design Architect
- Mentor Graphics Design Expedition 99 and 2000
- OrCAD 9.X PCB and Capture

Subject to changes. Please also observe the further product documentation!

WAGO GmbH & Co. KG

Hansastr. 27

32423 Minden

Phone: +49571 887-0 | Fax: +49571 887-169

Email: info.de@wago.com | Web: www.wago.com

Do you have any questions about our products?

We are always happy to take your call at +49 (571) 887-44222.



- PADS PowerPCB 3, 3.5, 4.X, and 5.X
- PADS PowerPCB and PowerLogic 3.0
- PCAD 2000, 2001, 2002, 2004, and 2006
- Pulsonix 8.5 or newer
- STL
- 3D STEP
- TARGET 3001!
- View Logic ViewDraw
- Quadcept
- Zuken CadStar 3 and 4
- Zuken CR-5000 and CR-8000

PCB Component Libraries (EDA), PCB CAD Library Ultra Librarian

CAE data

ZUKEN Portal 2061-1601/998-404	URL	Download
--------------------------------	---------------------	--------------------------

Environmental Product Compliance

Compliance Search

Environmental Product Compliance 2061-1601/998-404 THR PCB terminal block; push-button; 1.5 mm ² ; Pin spacing 6 mm; 1-pole; Push-in CAGE CLAMP®; in tape-and-reel packaging; 1,50 mm ² ; white	URL	Download
---	---------------------	--------------------------

Installation Notes

Conductor termination

Subject to changes. Please also observe the further product documentation!



Inserting solid conductors via push-in termination.

Conductor termination



Easy conductor removal, e.g., via operating tool (206-861)

Subject to changes. Please also observe the further product documentation!